



为您的产品保驾护航

PRODUCT DATASHEET

Electro-Static Discharge

JED523-3.3V-C ESD

## Features

- Package: SOD-523
- Protects one data line
- Ultra low leakage: nA level
- Operating voltage: 3.3V
- Ultra low clamping voltage
- Complies with following standards:
  - IEC 61000-4-2 (ESD) immunity test  
Air discharge:  $\pm 30\text{kV}$   
Contact discharge:  $\pm 30\text{kV}$
  - IEC61000-4-5 (Lightning) 8A (8/20 $\mu\text{s}$ )
- RoHS compliant

## Applications

- Cellular Handsets and Accessories
- Personal Digital Assistants
- Notebooks and Handhelds
- Portable Instrumentation
- Digital Cameras
- Peripherals
- Audio Players
- Keypads, Side Keys, LCD Displays

## Pin Description

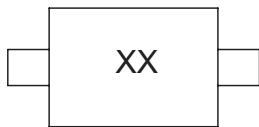

## Schematic Diagram

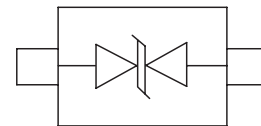

### Limiting Values( $T_A = 25\text{ }^\circ\text{C}$ , unless otherwise specified)

Symbol	Parameter	Conditions	Value	Unit
V <sub>ESD</sub>	Electrostatic Discharge Voltage	IEC 61000-4-2;Contact Discharge	$\pm 30$	kV
		IEC 61000-4-2;Air Discharge	$\pm 30$	kV
P <sub>PP</sub>	Peak Pulse Power	t <sub>P</sub> =8/20 $\mu\text{s}$	80	W
I <sub>PP</sub>	Peak Pulse Current	t <sub>P</sub> =8/20 $\mu\text{s}$	8	A
T <sub>J</sub>	Operating Temperature Range	-	-55 to +125	$^\circ\text{C}$
T <sub>stg</sub>	Storage Temperature Range	-	-55 to +150	$^\circ\text{C}$

### Electrical Characteristics( $T_A = 25\text{ }^\circ\text{C}$ , unless otherwise specified)

Symbol	Parameter	Conditions	Min	Typ.	Max	Unit
V <sub>RWM</sub>	Reverse Working Voltage	T <sub>A</sub> =25 $^\circ\text{C}$	-	-	3.3	V
V <sub>PT</sub>	Punch-Through Voltage	I <sub>T</sub> =2 $\mu\text{A}$	3.8	-	-	V
V <sub>SB</sub>	Snap-Back Voltage	I <sub>T</sub> =50mA	3.5	-	-	V
I <sub>R</sub>	Reverse Leakage Current	V <sub>RWM</sub> =3.3V;T <sub>A</sub> =25 $^\circ\text{C}$	-	0.01	0.2	$\mu\text{A}$
V <sub>C</sub>	Clamping Voltage	I <sub>PP</sub> =1A(8 x 20 $\mu\text{s}$ pulse)	-	-	6	V
V <sub>C</sub>	Clamping Voltage	I <sub>PP</sub> =5A(8 x 20 $\mu\text{s}$ pulse)	-	-	8	V
V <sub>C</sub>	Clamping Voltage	I <sub>PP</sub> =8A(8 x 20 $\mu\text{s}$ pulse)	-	-	10	V
C <sub>J</sub>	Junction Capacitance	V <sub>R</sub> =0V,f=1 MHz	-	12.5	25	pF

Typical Characteristics

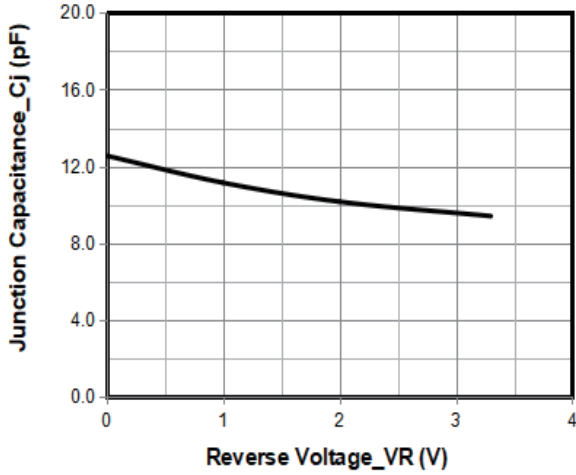

Junction Capacitance vs. Reverse Voltage

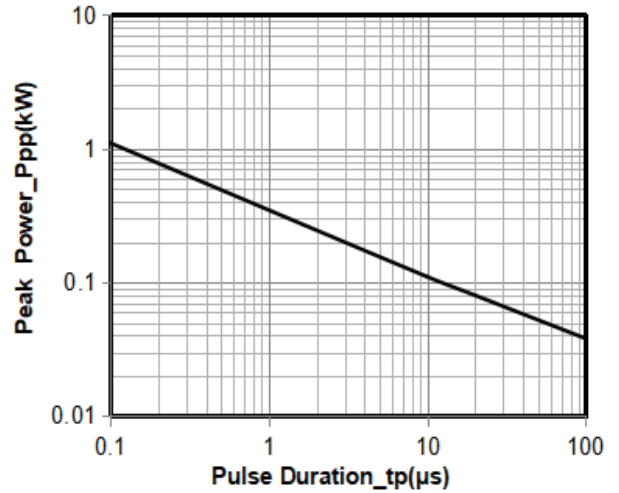

Peak Pulse Power vs. Pulse Time

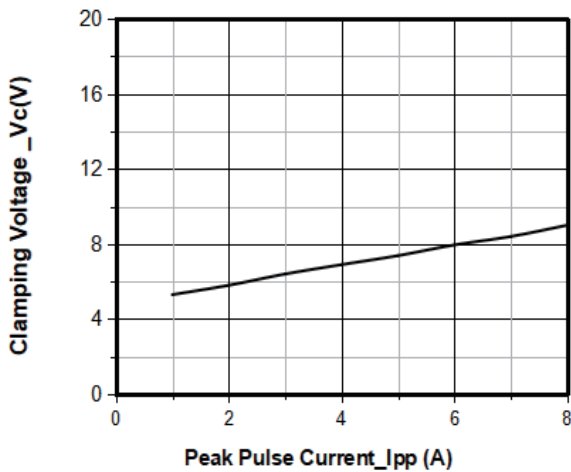

Clamping Voltage vs. Peak Pulse Current (tp = 8/20us)

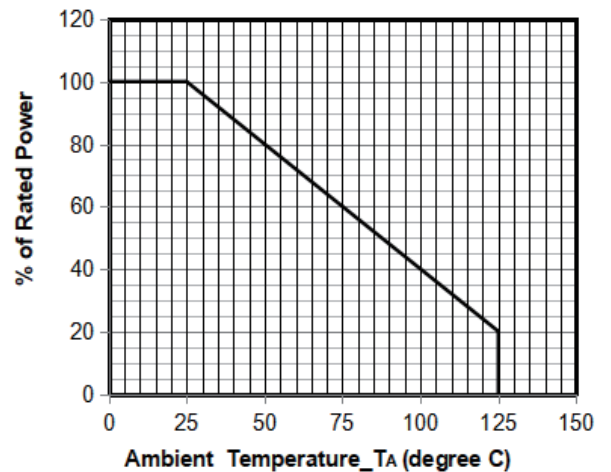

Power Derating Curve

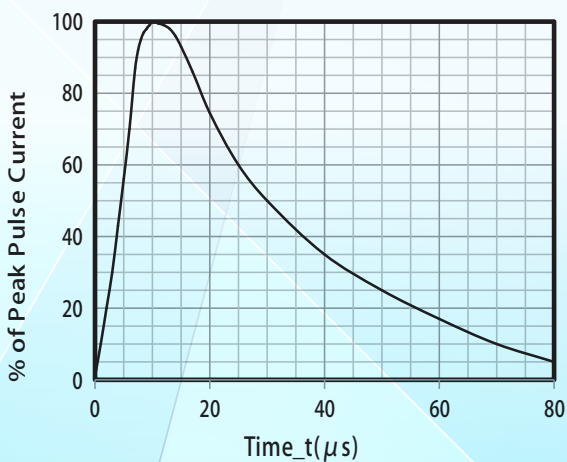

8 X 20 μs Pulse Waveform

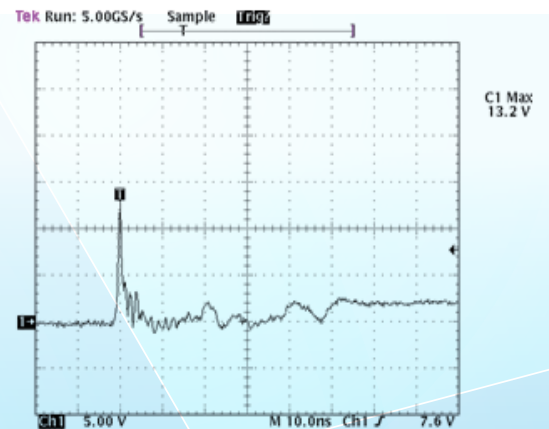

ESD Clamping Voltage  
8 kV Contact per IEC61000-4-2

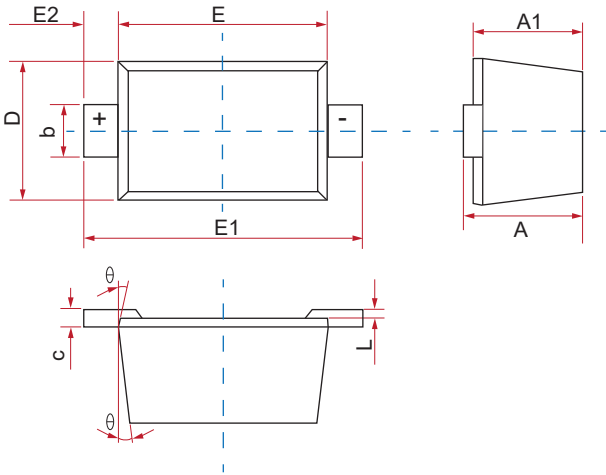
**Physical Dimensions(mm.)**

Symbol	Dimensions In Millimeters			Dimensions In Inches		
	Min	Nom	Max	Min	Nom	Max
A	0.51	--	0.77	0.020	--	0.031
A1	0.50	--	0.70	0.020	--	0.028
b	0.25	--	0.35	0.010	--	0.014
c	0.08	--	0.15	0.003	--	0.006
D	0.75	--	0.85	0.030	--	0.033
E	1.10	--	1.30	0.043	--	0.051
E1	1.50	--	1.70	0.059	--	0.067
E2	0.20REF			0.008REF		
L	0.01	--	0.07	0.001	--	0.003
θ	7°REF			7°REF		

**Suggested Land Pattern**

Unit:mm

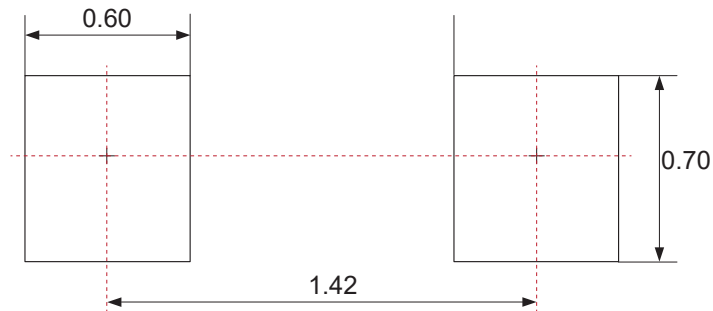
**Packaging Quantity**

Part Number	Delivery Form	Delivery Quantity
JED523-3.3V-C	7"T&R	3,000

### Soldering Parameters

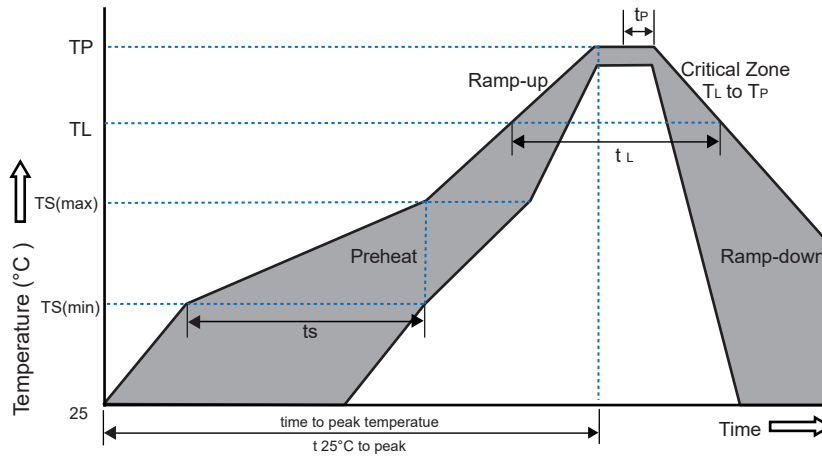

Reflow Condition		Pb-Free Assembly
Pre-heat	-Temperature Min( $T_{s(min)}$ )	+150°C
	-Temperature Max( $T_{s(max)}$ )	+200°C
	-Time(Min to Max)( $t_s$ )	60~180 secs.
Average ramp up rate (Liquid us Temp( $T_L$ ) to peak)		3°C/sec. Max
Ts(max) to $T_L$ - Ramp-up Rate		3°C/sec. Max
Reflow	-Temperature( $T_L$ )(Liquid us)	+217°C
	-Temperature ( $t_L$ )	60~150 secs.
Peak Temp ( $T_P$ )		+260(+0/-5)°C
Time within 5°C of actual Peak Temp ( $t_p$ )		30 secs. Max
Ramp-down Rate		6°C/sec. Max
xTime 25°C to Peak Temp (TP)		8 min. Max
Do not exceed		+260°C

### Part Number System

## JE D523 - 3.3V - C

