

SPECIFICATION FOR APPROVAL

承 認 書

Description : Piezo Audio Indicator

Kingstate Part No. : KPEG352

Customer's Model No. : _____

Specification No. : PKD-7730

Number Of The Edition : 1.4

CUSTOMER'S APPROVED SIGNATURE

| | | |
|-------------------------------|--|--|
| CUSTOMER'S APPROVED SIGNATURE | | |
| | | |



志豐電子股份有限公司 KINGSTATE ELECTRONICS CORP.

Address : 10F, No. 69-11, Sec. 2, Chung Cheng E. Rd., Tamshui County, Taipei Hsien, Taiwan, R.O.C.

International sales dept: TEL : 886-2-2809-5651 FAX:886-2-2809-7151

Domestic sales dept: TEL : 886-2-2809-0668 FAX:886-2-28096748

<http://www.kingstate.com.tw>

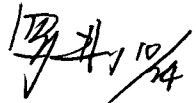
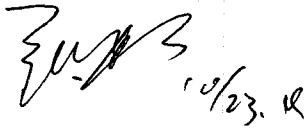
| Approved by | Checked by | Issued by |
|---|---|-------------------|
|  |  10/23. R | 陽志明 2019.10.23 |

A. SCOPE 範疇

This specification applies piezo audio indicator, **KPEG352**

此規格書適用於壓電式蜂鳴器 **KPEG352**

B. SPECIFICATION 規格

| No. | Item | Unit | Specification | Condition |
|-----|--|------|---|------------------------------------|
| 1 | Resonant frequency 共振頻率 | KHz | 2.8±0.5 | |
| 2 | Operating Volt. range 操作電壓範圍 | VDC | 3 ~ 28 | |
| 3 | Current consumption 消耗電流 | mA | MAX 10 | at 12VDC |
| 4 | Sound pressure level 輸出音壓 | dB | MIN 89 | at 30cm/12VDC |
| 5 | Rated Voltage 額定電壓 | VDC | 12 | |
| 6 | Tone 聲音 | | Continuous 直音 | at 12VDC |
| 7 | Operating temp. 操作溫度 | °C | -30 ~ +85 | |
| 8 | Storage temp. 儲存溫度 | °C | -40 ~ +95 | |
| 9 | Dimension 尺寸 | mm | φ42.0xH14.0 | See appearance drawing 請參照外觀尺寸圖 |
| 10 | Weight (MAX) 重量 | gram | 12.0 | |
| 11 | Material 材質 | | ABS UL-94 1/16" HB HIGH HEAT (BLACK) | |
| 12 | Terminal 端子 | | Pin type (鍍化金/Plating Au) | See appearance drawing 請參照外觀尺寸圖 |
| 13 | Environmental Protection Regulation 環保法規 | | RoHS 2.0 | |

C. APPEARANCE DRAWING 外觀尺寸

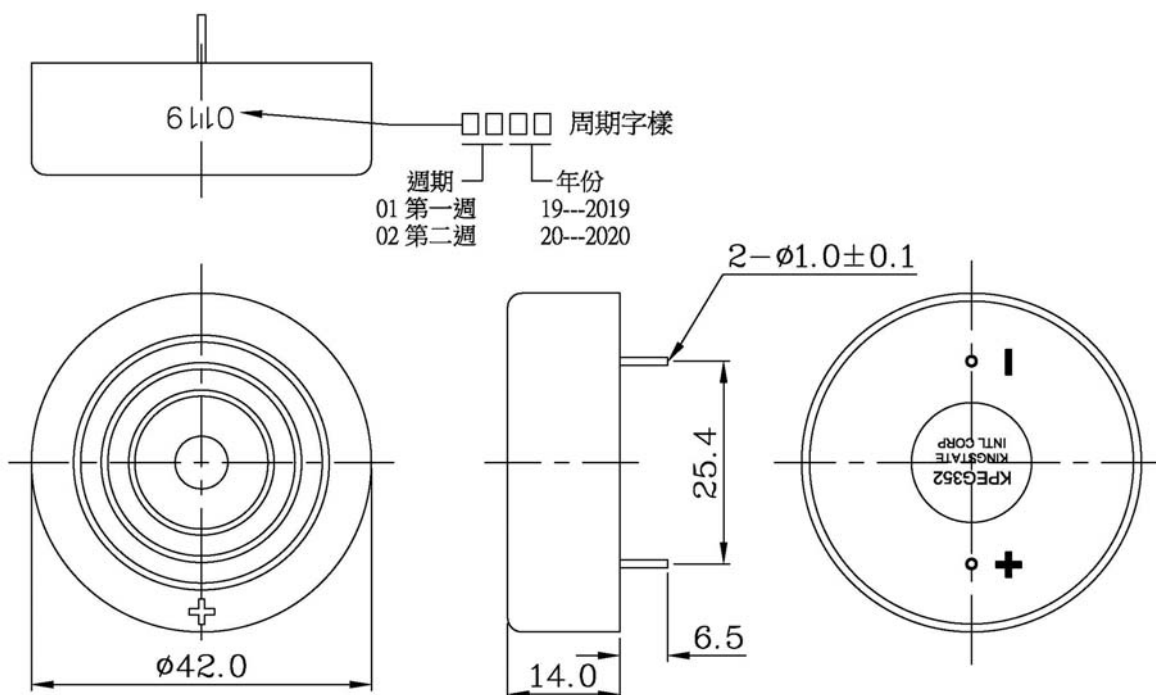

Tol: ± 0.5 Unit: mm

D. Measuring Method 測量方法

1.S.P.L. Measuring Circuit 音壓測試接線圖

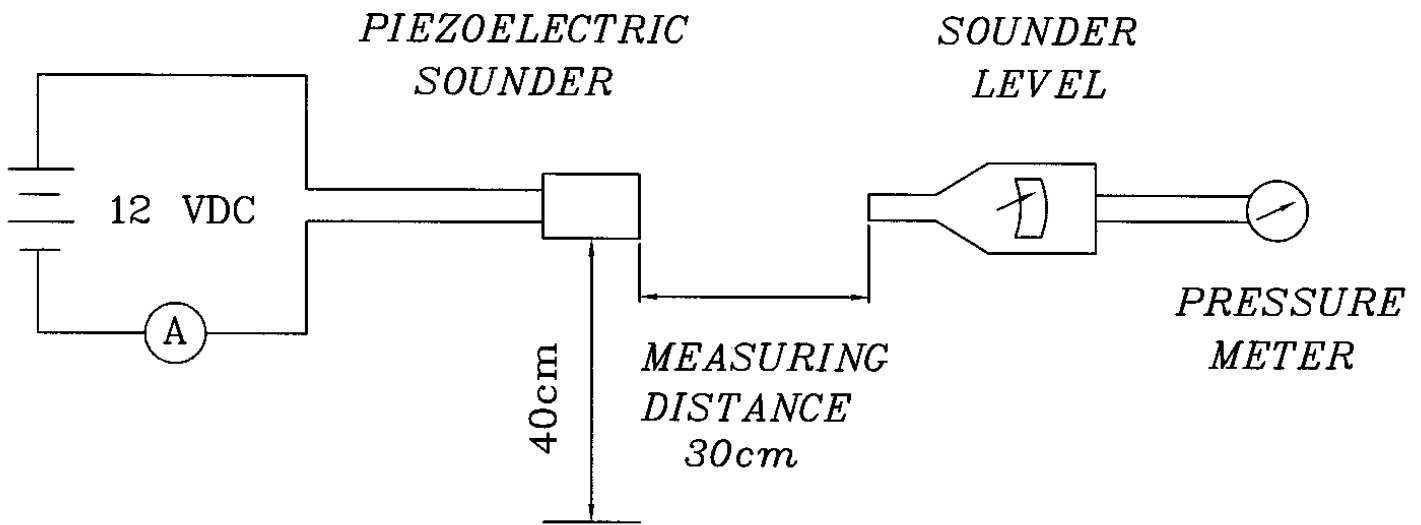

Mic : RION S.P.L meter UC30 or equivalent

Mic : RION 噪音計 UC30 或同等品

E. VOLTAGE: SOUND PRESSURE LEVEL / VOLTAGE: CURRENT CONSUMPTION

CHARACTERISTICS 電壓與音壓/電壓與耗電流之特性

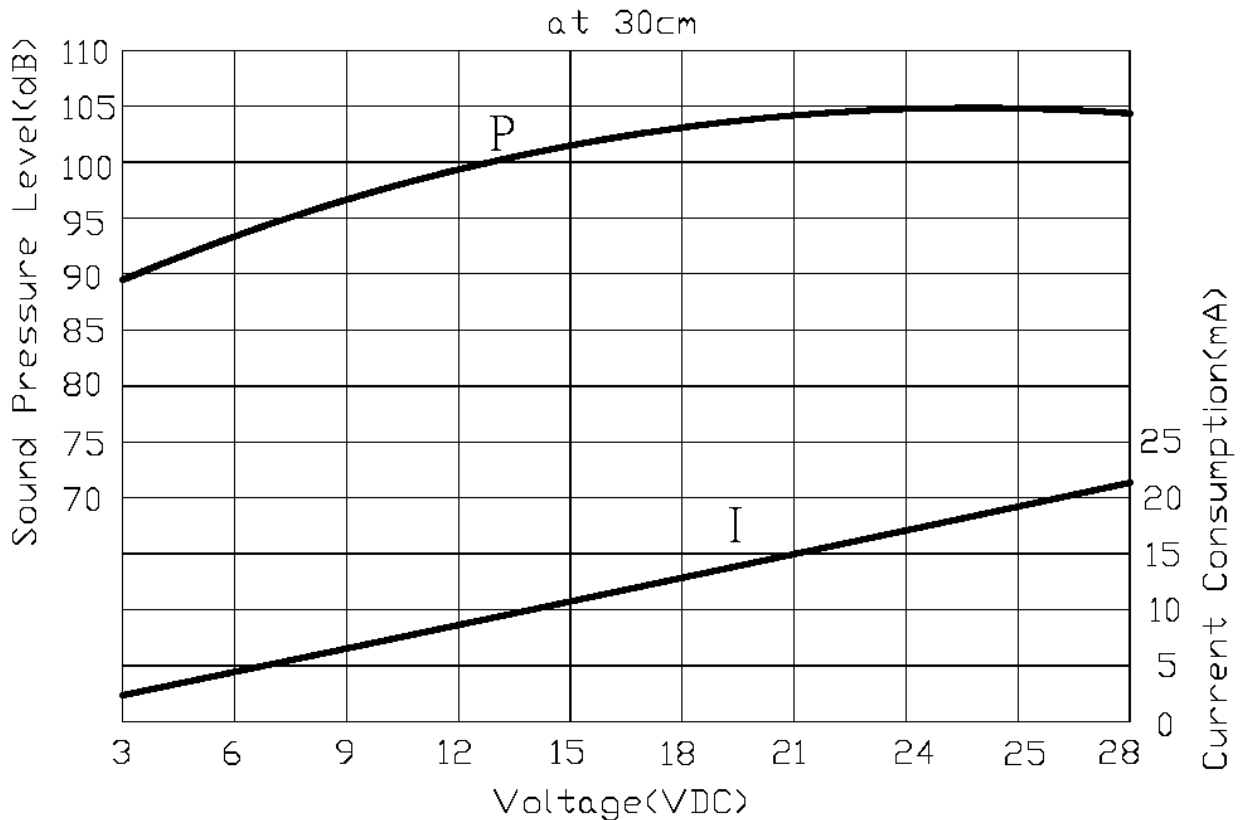

F. MECHANICAL CHARACTERISTICS 機械特性

| No. | Item | Test condition | Evaluation standard |
|-----|--------------------------------------|--|---|
| 1 | Solderability 焊錫附著性 | Lead terminals are immersed in rosin for 5 seconds and then immersed in solder bath of $+270\pm 5^{\circ}\text{C}$ for 3 ± 1 seconds. 端子部份浸入松香溶液 5 秒後,再浸入 $+270\pm 5^{\circ}\text{C}$ 熔融焊錫槽中 3 ± 1 秒。 | 90% min. lead terminals shall be wet with solder. (Except the edge of terminal) 浸入端子部份附著焊錫 90% 以上。(末端斷面不算) |
| 2 | Soldering Heat Resistance 焊錫耐熱性 | Lead terminal are immersed up to 1.5mm from sounder's body in solder bath of $+300\pm 5^{\circ}\text{C}$ for 3 ± 0.5 seconds or $+260\pm 5^{\circ}\text{C}$ for 10 ± 1 seconds. 距離端子根部 1.5mm 的位置,浸入 $+300\pm 5^{\circ}\text{C}$ 的焊錫槽 3 ± 0.5 秒,或 $+260\pm 5^{\circ}\text{C}$ 的焊錫槽 10 ± 1 秒。 | No interference in operation 操作無任何不良 |
| 3 | Terminal Mechanical Strength 端子強度 | The force 10 seconds of 9.8N (1.0kg) is applied to each terminal in axial direction. 各端子的軸方向施以 9.8N (1.0kg) 的力量 10 秒。 | No damage and cutting off 端子不鬆動, 不脫落 |
| 4 | Vibration 振動測試 | Buzzer shall be measured after being applied vibration of amplitude of 1.5mm with 10 to 55hz band of vibration frequency to each of 3 per-pendicular directions for 2 hours. 振動週波數 10~55HZ、全振幅 1.5mm 於 X.Y.Z 3 個方向,各 2 小時。 | The value of oscillation frequency/ current consumption should be in $\pm 10\%$ compared with initial ones. The SPL should be in $\pm 10\text{dB}$ compared with initial one. |
| 5 | Drop test 落下測試 | The part only shall be dropped from a height of 75cm onto a 40mm thick wooden board 3 times in 3 axes (X.Y.Z). (a total of 9 times). 單體從 75 公分高處, X.Y.Z.3 個方向,各 3 回,落於 40mm 厚木板上。 | 諧振頻率與消耗電流變化量須在 $\pm 10\%$ 內. 輸出音壓變化量須在 $\pm 10\text{dB}$ 內. |

G. ENVIRONMENT TEST 環境測試

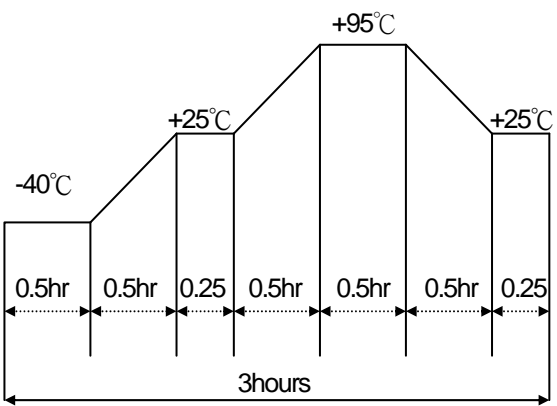
| No. | Item | Test Condition | Evaluation standard |
|-----|----------------------------|--|--|
| 1 | High temp. test 高溫測試 | After being placed in a chamber at $+95^{\circ}\text{C}$ for 240 hours 置於 $+95^{\circ}\text{C}$ 環境中 240 小時 | Being placed for 4 hours at $+25^{\circ}\text{C}$, buzzer shall be measured. The value of oscillation frequency/ current consumption should be in $\pm 10\%$ compared with initial ones. The SPL should be in $\pm 10\text{dB}$ compared with initial one. 經測試後, 靜置於 $+25^{\circ}\text{C}$ (室溫) 環境中 4 小時後, 諧振頻率與消耗電流變化量須在 $\pm 10\%$ 內. 輸出音壓變化量須在 $\pm 10\text{dB}$ 內. |
| 2 | Low temp. test 低溫測試 | After being placed in a chamber with -40°C for 240 hours 置於 -40°C 環境中 240 小時 | |
| 3 | Humidity test 相對濕度測試 | After being placed in a chamber at $+40^{\circ}\text{C}$ and $90\pm 5\%$ relative humidity for 240 hours 置於 $+40^{\circ}\text{C}$, 相對濕度 $90\pm 5\%$ 環境中 240 小時 | |
| 4 | Temp. cycle test 溫度循環試驗 | The part shall be subjected to 5 cycles. One cycle shall be consist of: 單體承受溫度循環測試 5 次, 其循環內容如圖示:  | |

H. RELIABILITY TEST 信賴性測試

| No. | Item | Test condition | Evaluation standard |
|-----|-----------------------------|--|---|
| 1 | Operating life test 壽命測試 | 1. Continuous life test 高溫壽命測試(連續) 48 hours continuous operation at +70°C with rated voltage applied. 在+70°C環境下,以額定電壓連續操作48小時 2. Intermittent life test 室溫壽命測試(間歇) A duty cycle of 1 minute on, 1 minutes off, a minimum of 5000 times at room temp.(+25±2°C) and rated voltage applied 在室溫下(+25±2°C),以額定電壓操作,通電1分鐘/斷電1分鐘,測試5000次循環 | Being placed for 4 hours at +25°C, buzzer shall be measured. The value of oscillation frequency/ current consumption should be in ±10% compared with initial ones. The SPL should be in ±10dB compared with initial one. 經測試後,靜置於+25°C(室溫)環境中4小時後,諧振頻率與消耗電流變化量須在±10%內.輸出音壓變化量須在±10dB內. |

TEST CONDITION.

| | | | | |
|--------------------------|---|-----------------------------|----------------------|----------------------------|
| Standard Test Condition | : | a) Temperature : +5 ~ +35°C | b) Humidity : 45-85% | c) Pressure : 860-1060mbar |
| 一般測試條件 | : | a) 溫度 : +5 ~ +35°C | b) 濕度 : 45-85% | c) 氣壓 : 860-1060mbar |
| Judgement Test Condition | : | a) Temperature : +25 ± 2°C | b) Humidity : 60-70% | c) Pressure : 860-1060mbar |
| 爭議時測試條件 | : | a) 溫度 : +25 ± 2°C | b) 濕度 : 60-70% | c) 氣壓 : 860-1060mbar |

I. PACKING STANDARD 包裝規格

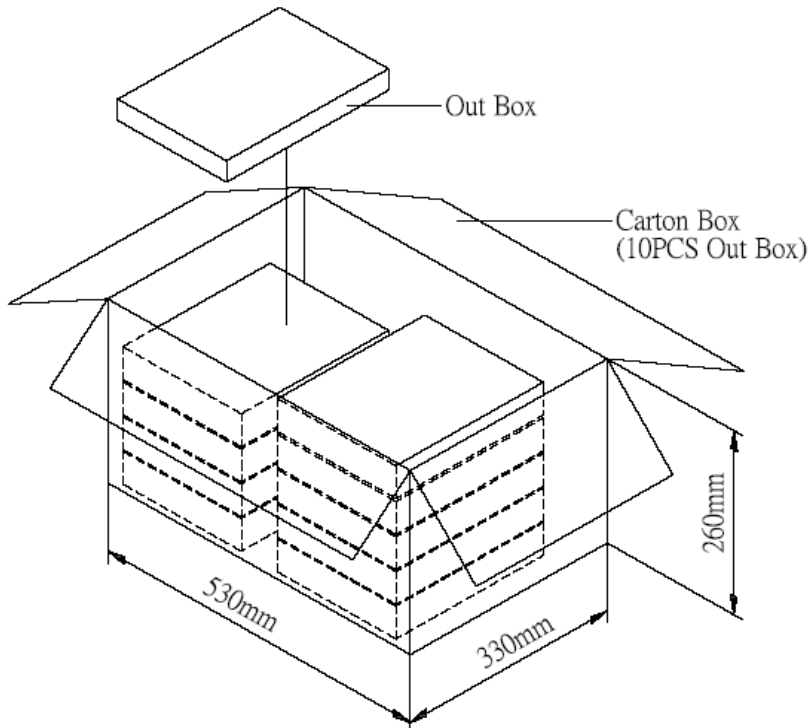
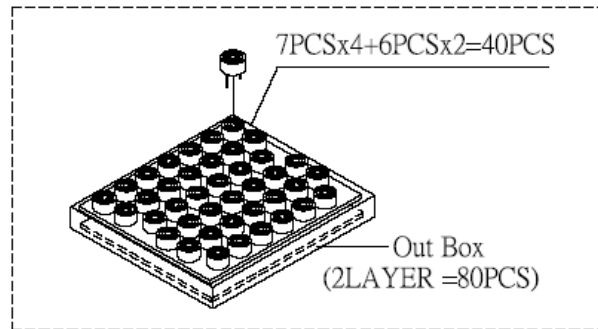

| | | |
|------------|-------------------|-----------------|
| Out Box | 310mmx248mmx49mm | 2x40PCS=80PCS |
| Carton Box | 530mmx330mmx260mm | 80PCSx10=800PCS |