

»Features

- Super fast switching time for high efficiency
- Low forward voltage drop
- High current capability
- High reliability
- High surge current capability
- Epitaxial construction

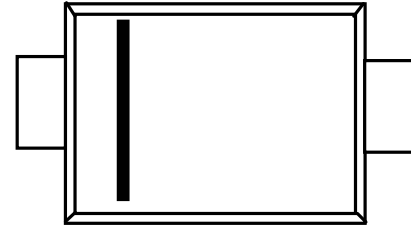

SMA(DO-214AC)

»General Description

- Case: molded plastic
- Polarity: Color band denotes cathode
- Package: SMA Plastic Package

» Maximum Ratings and Electrical Characteristics

Ratings at 25 °C ambient temperature unless otherwise specified.

Single phase half wave 60HZ. resistive or inductive load. For capacitive load current derate by 20%

	SYMBOL	ES2A	ES2B	ES2C	ES2D	ES2E	ES2G	ES2J	UNITS
Maximum Recurrent Peak Reverse Voltage	V _{RRM}	50	100	150	200	300	400	600	V
Maximum RMS Voltage	V _{RMS}	35	70	105	140	210	280	420	V
Maximum DC Blocking Voltage	V _{DC}	50	100	150	200	300	400	600	V
Maximum Average Forward Rectified Current at T _L = 110°C	I _(AV)	2.0							A
Peak Forward Surge Current 8.3ms Single half-sine-wave superimposed on rated T _j = 125°C	I _{FSM}	30							A
Maximum Forward Voltage at 2.0A DC	V _F	0.95				1.25			V
Maximum Reverse Current TA = 25°C at Rated DC Blocking Voltage TA = 100°C	I _R	5.0							μ A
Maximum reverse recovery time (Note 1)	t _{rr}	35							ns
Typical Junction Capacitance (Note 2)	C _j	17							pF
Typical Thermal Resistance (Note 3)	R _{QJA}	60							°C/W
Operating Junction Temperature Range	T _j	— 55 to 150							°C
Storage Temperature Range	T _{STG}	— 55 to 150							°C

NOTES: 1.Measured with I_F=0.5A, I_R=1A, I_{RR}=0.25A

2.Measured at 1.0 MHz and applied reverse voltage of 4.0V DC

»Typical Performance Characteristics ((T_J = 25 °C, unless otherwise noted))

FIG. 1 -- TYPICAL FORWARD CHARACTERISTIC

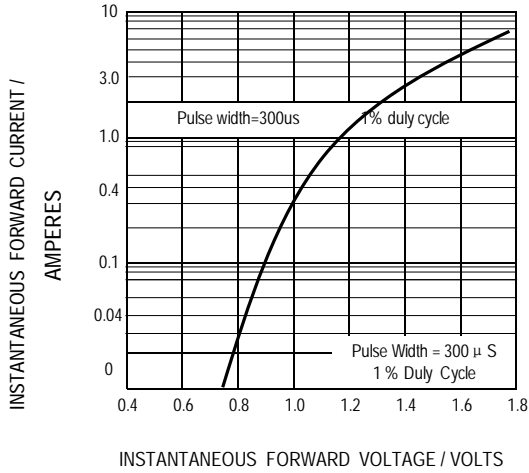

FIG. 2 -- TYPICAL JUNCTION CAPACITANCE

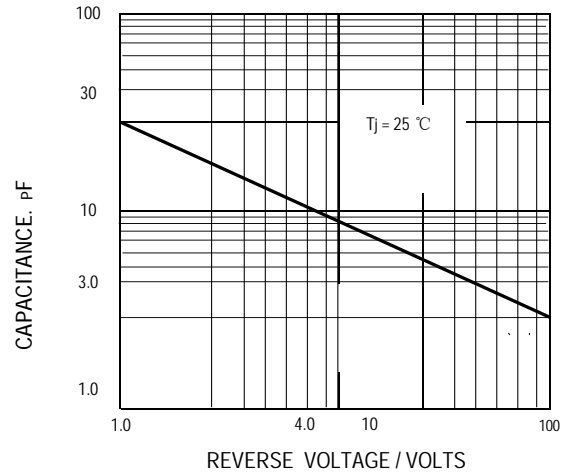

FIG. 3 -- FORWARD CURRENT DERATING CURVE

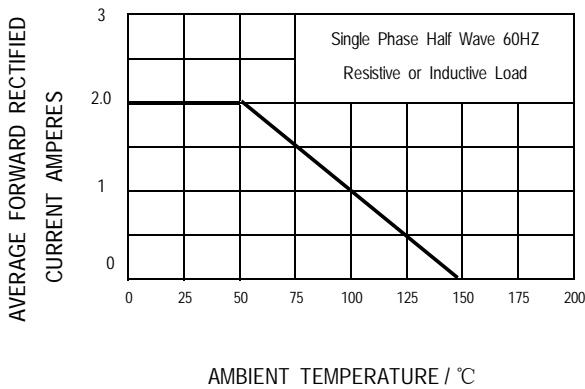

FIG. 4 -- PEAK FORWARD SURGE CURRENT

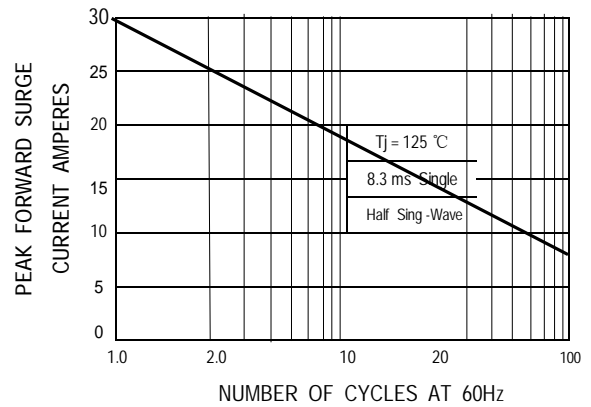
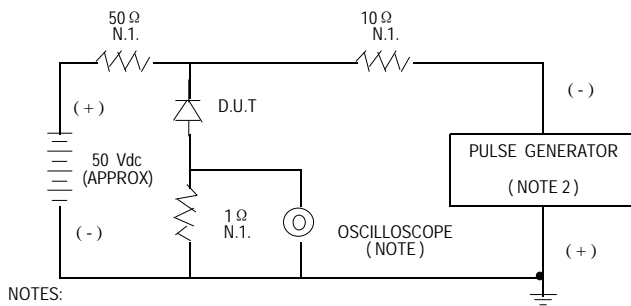
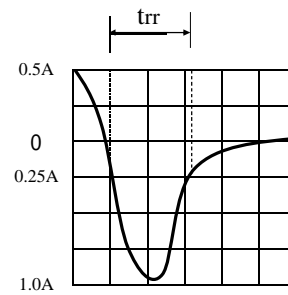

FIG. 5 -- TEST CIRCUIT DIAGRAM AND REVERSE RECOVERY TIME CHARACTERISTIC



- NOTES:
1. RISE TIME = 7n SEC MAX. INPUT IMPEDANCE = 1 MEGOHM. 22PF
 2. RISE TIME = 10n SEC MAX. SOURCE IMPEDANCE = 50 OHM.



SET TIME BASE FOR 15 ns/cm

»Package Information

SMA

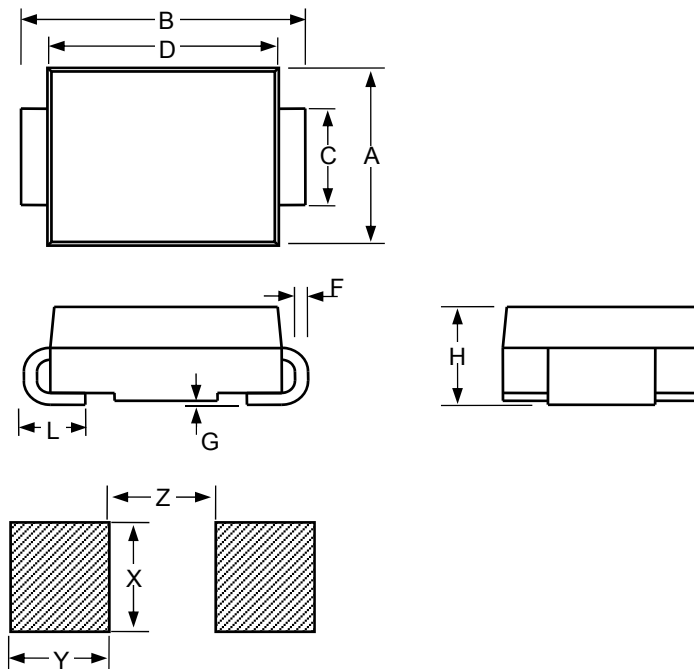

SMA						
Dimension	Inches			Millimeters		
	MIN	NOM	MAX	MIN	NOM	MAX
A	0.1		0.11	2.54		2.8
B	0.194		0.223	4.93		5.66
C	0.051		0.067	1.3		1.7
D	0.157		0.177	3.99		4.5
F	0.006		0.012	0.152		0.305
G	-		0.008	-		0.203
H	0.078		0.095	1.98		2.42
L	0.03		0.06	0.76		1.52
X		0.085			2.16	
Y		0.07			1.78	
Z		0.079			2	

»Ordering information

Part Number	ES2A	ES2B	ES2C	ES2D	ES2E	ES2G	ES2J
Marking	ES2A	ES2B	ES2C	ES2D	ES2E	ES2G	ES2J
Base qty	5K	5K	5K	5K	5K	5K	5K