

### ●For 3-Phase Motor Drivers

Part Number	Circuit Count	V <sub>CE0</sub> (V)/ V <sub>DSS</sub> (V)/ V <sub>CEs</sub> (V)	I <sub>C</sub> (A)/ I <sub>D</sub> (A)	h <sub>FE</sub> (min)	R <sub>Ds(ON)</sub> max (Ω)	Equivalent Circuit	Package
STA303A	3	100	4	1000		4	SIP8 (STA8Pin)
STA302A	3	-50	-4	1000		5	SIP8 (STA8Pin)
SLA5212	6	35	±8		70m	14	SIP15 with Fin (SLA15Pin)
SLA5096	6	55	±8		80m	14	SIP15 with Fin (SLA15Pin)
SLA5059	6	60	±4		0.55	6	SIP12 with Fin (SLA12Pin)
SLA5060	6	60	±6		0.22	6	SIP12 with Fin (SLA12Pin)
SLA5061	6	60	±10		0.14	6	SIP12 with Fin (SLA12Pin)
SLA5064	6	60	±10		0.14	7	SIP12 with Fin (SLA12Pin)
SMA6080	6	±60	±2	2000		9	SIP12 (SMA12Pin)
SMA6010	6	±60	±4	2000		9	SIP12 (SMA12Pin)
SLA6012	6	±60	±4	2000		8	SIP12 with Fin (SLA12Pin)
SMA5127	6	±60	±4		0.55	10	SIP12 (SMA12Pin)
SLA5022	6	±60	±6	2000	0.22	11	SIP12 with Fin (SLA12Pin)
SLA6023	6	±60	±6	2000		8	SIP12 with Fin (SLA12Pin)
SLA6024	6	±60	±8	2000		8	SIP12 with Fin (SLA12Pin)
SLA6026	6	±60	±10	2000		8	SIP12 with Fin (SLA12Pin)
SMA5125	6	±60	±10		0.14	7	SIP12 (SMA12Pin)
SLA6022	6	±80	±5	2000		8	SIP12 with Fin (SLA12Pin)
SLA6020	6	±100	±5	2000		9	SIP12 with Fin (SLA12Pin)
SMA5130	6	±250	±2.5	2000	0.9	16	SIP15 (SMA15Pin)
→ SMA5131	6	250	2		1.8	13	SIP12 (SMA12Pin)
SMA5112	6	250	7		0.5	13	SIP12 (SMA12Pin)
SMA5117	6	250	7		0.25	13	SIP12 (SMA12Pin)
SMA5132	6	500	1.5		4	13	SIP12 (SMA12Pin)
SMA5133	6	500	2.5		2	13	SIP12 (SMA12Pin)
SLA5075	6	500	±5		1.4	12	SIP15 with Fin (SLA15Pin)
SMA5118	6	500	±5		1.4	13	SIP12 (SMA12Pin)
SLA5201	6	600	7			15	SIP15 with Fin (SLA15Pin)

### ●For Driving Stepping Motor with Two Supplies

Part Number	Circuit Count	V <sub>CE0</sub> (V)/ V <sub>DSS</sub> (V)	I <sub>C</sub> (A)/ I <sub>D</sub> (A)	h <sub>FE</sub> (min)	R <sub>Ds(ON)</sub> max (Ω)	Equivalent Circuit	Package
SMA6511	5	100±15/-60	1.5/-3	2000		17	SIP12 (SMA12Pin)

### ●For 5-Phase Motor Drive

Part Number	Circuit Count	V <sub>CE0</sub> (V)/ V <sub>DSS</sub> (V)	I <sub>C</sub> (A)/ I <sub>D</sub> (A)	h <sub>FE</sub> (min)	R <sub>Ds(ON)</sub> max (Ω)	Equivalent Circuit	Package
SLA5074	4	60	5		0.3	18	SIP15 with Fin (SLA15Pin)
SLA5065	4	60	7		0.1	18	SIP15 with Fin (SLA15Pin)
SLA5073	6	60	5		0.3	14	SIP15 with Fin (SLA15Pin)
SLA5068	6	60	7		0.1	14	SIP15 with Fin (SLA15Pin)

●Equivalent Circuit (for Motor Driver)

④

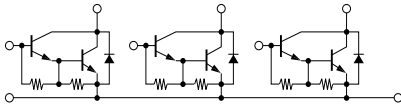

⑤

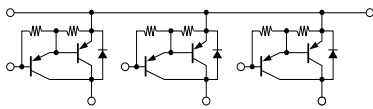

⑥

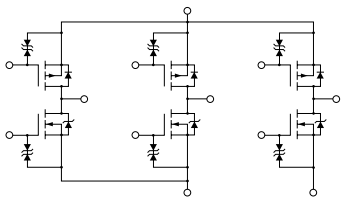

⑦

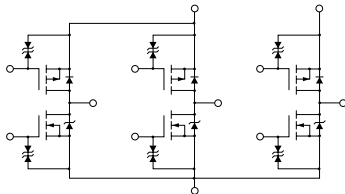

⑧

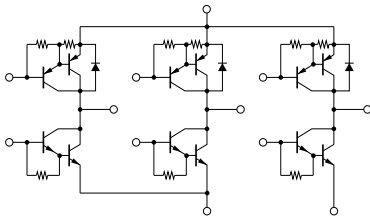

⑨

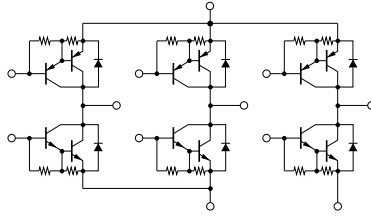

⑩

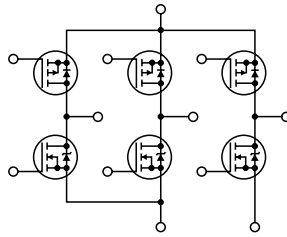

⑪

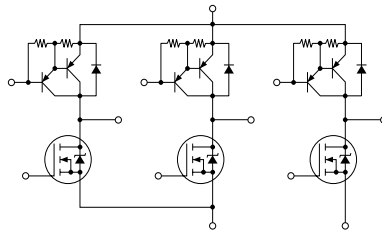

⑫

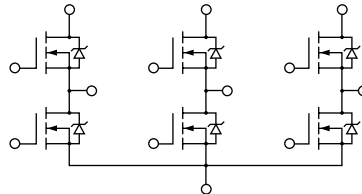

⑬

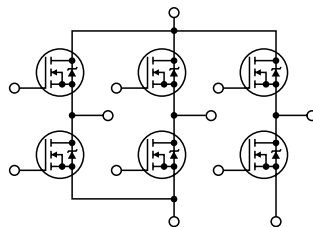

⑭

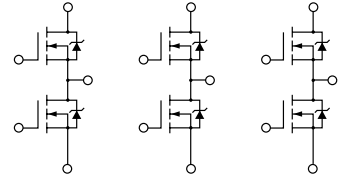

⑮

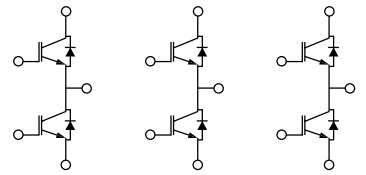

⑯

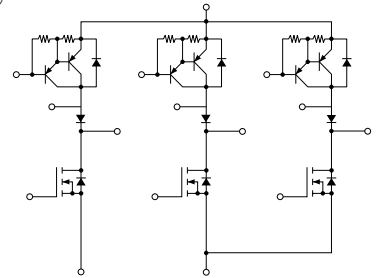

⑰

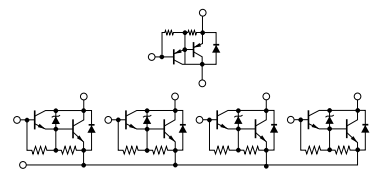

⑱

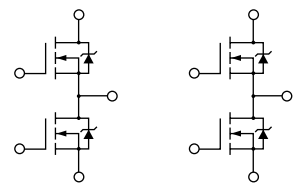

• SIP 8 (STA8Pin)

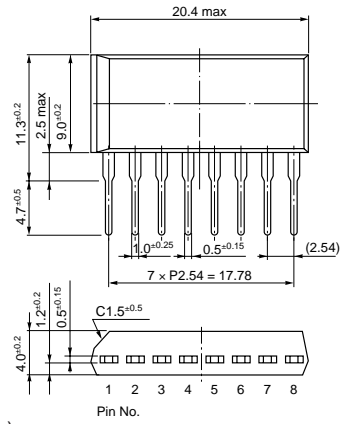

• SIP 10 (STA10Pin)

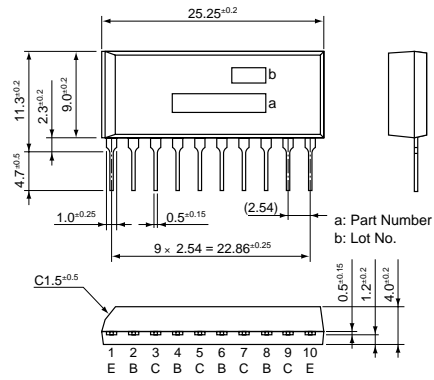

• SIP 12 (SMA12Pin)

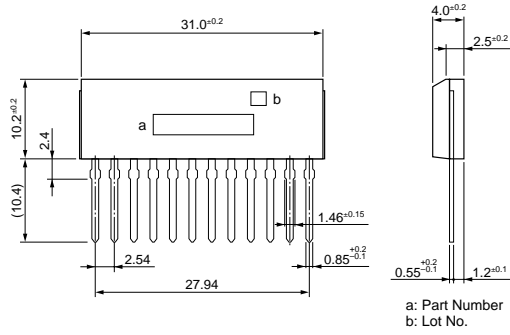

• SIP 15 (SMA15Pin)

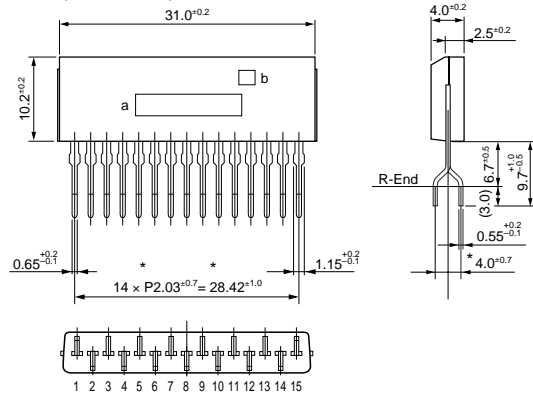

• SIP 12 with Fin (SLA12Pin)

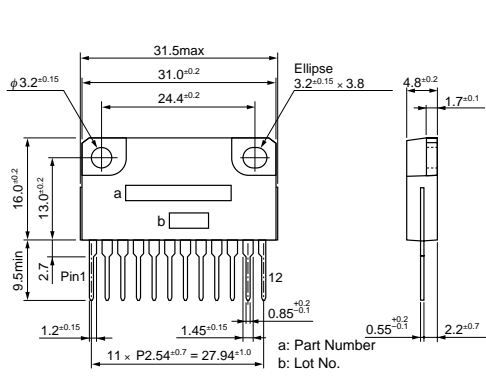

• SIP 15 with Fin (SLA15Pin)

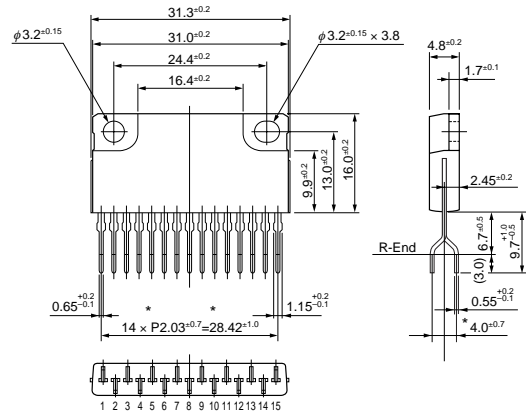

• SIP 15 with Fin (SLA15Pin)

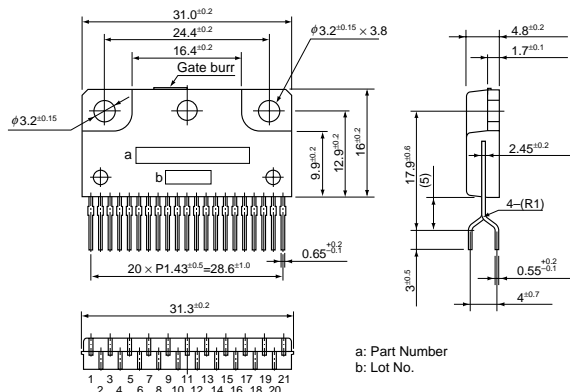

(Unit:mm)