

10 9 8 7 6 5 4 3 2 1

番号 NO.	名称 NAME	原料 MATERIAL	数量 QTY	仕上げ FINISH
①	ウエハー WAFER	ナイロン NYLON	1	UL94V-0
②	ピン PIN	黄銅 BRASS	N	全体錫メッキ PRE-TINNED
③	フィッティングネール FITTING NAIL	黄銅 BRASS	2	錫メッキ TIN PLATING

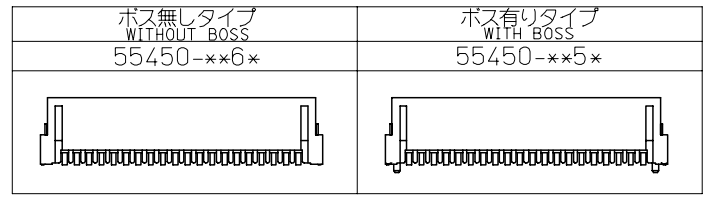

54596-***
リセプトフルアセンブリ
REC. ASS'Y

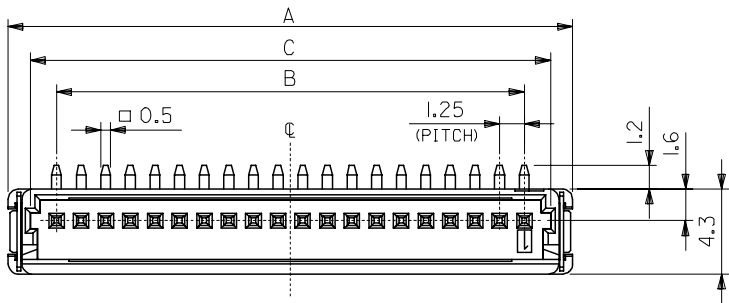
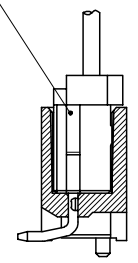

嵌合図
MATING REC.

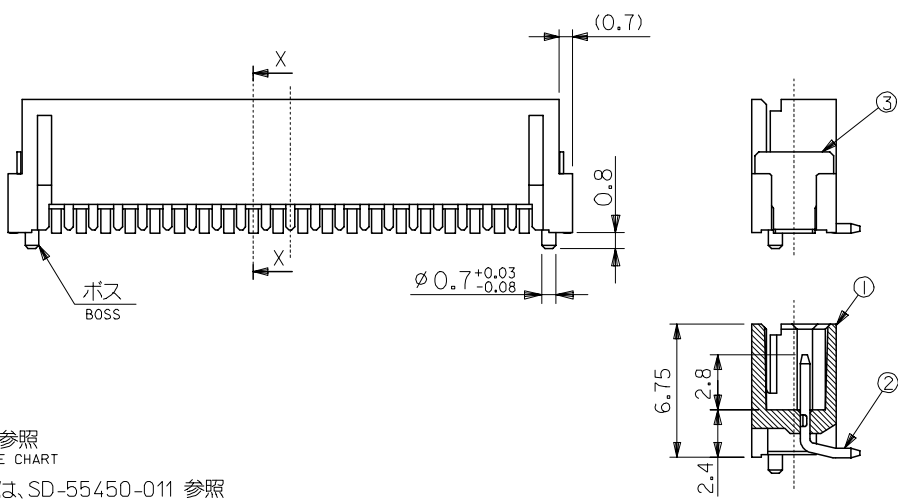

断面 X-X
SECTION X-X

27.05	26.25	26.4	23.75	28.65	20	55450-20**
25.8	25	25.15	22.5	27.4	19	-19**
24.55	23.75	23.9	21.25	26.15	18	-18**
23.3	22.5	22.65	20	24.9	17	-17**
22.05	21.25	21.4	18.75	23.65	16	-16**
20.8	20	20.15	17.5	22.4	15	-15**
19.55	18.75	18.9	16.25	21.15	14	-14**
18.3	17.5	17.65	15	19.9	13	-13**
17.05	16.25	16.4	13.75	18.65	12	-12**
15.8	15	15.15	12.5	17.4	11	-11**
14.55	13.75	13.9	11.25	16.15	10	-10**
13.3	12.5	12.65	10	14.9	9	-09**
12.05	11.25	11.4	8.75	13.65	8	-08**
10.8	10	10.15	7.5	12.4	7	-07**
9.55	8.75	8.9	6.25	11.15	6	-06**
8.3	7.5	7.65	5	9.9	5	-05**
7.05	6.25	6.4	3.75	8.65	4	-04**
5.8	5	5.15	2.5	7.4	3	-03**
4.55	3.75	3.9	1.25	6.15	2	55450-02**
E	D	C	B	A	極数 CIRCUIT SIZE	△ 製品番号 MATERIAL NO.

注) NOTES

1. 原料および仕上げ: 表参照
MATERIAL AND FINISH: SEE CHART
2. インボス梱包品の詳細は、SD-55450-011 参照
REFER TO THE SD-55450-011 FOR THE EMBOSSED PACKAGING.
3. 端子平坦度は 0.15 MA X.とする。
COPLANALITY TO BE 0.15 MAX.

△ 製品番号
MATERIAL NO.

55450-****

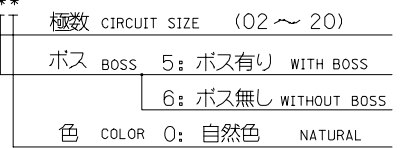

5. 本製品は 55450-**10/**30/**70/**80 の鉛フリー品である。
THIS PRODUCT IS LEAD FREE OF 55450-**10/**30/**70/**80.

REVISED EC NO: J2007-0566 DRWN: OTANI CHKD: NUKITA APPR: NUKITA	DESCRIPTION	GENERAL TOLERANCES (UNLESS SPECIFIED)		DIMENSION STYLE MM ONLY		SCALE 4:1	DESIGN UNITS METRIC	THIRD ANGLE PROJECTION	
		10 UNDER	±0.2	DRAWN BY N. AIDA	DATE '05/02/01	TITLE MINI M12 1-ROW SMT WAFER ASS'Y (TIN) -LEAD FREE-		MOLEX INCORPORATED	
10 OVER 30 UNDER	±0.25	CHECKED BY K. TOJO	DATE '05/02/01	APPROVED BY N. UKITA		DATE '05/02/01	DOCUMENT NO. SD-55450-010		SHEET NO. 1 OF 2
30 OVER	±0.3	ANGULAR ±3 °		MATERIAL NO. SEE CHART		MATERIAL NO. SEE CHART		SHEET NO. 1 OF 2	
DRAFT WHERE APPLICABLE MUST REMAIN WITHIN DIMENSIONS		SIZE A3		THIS DRAWING CONTAINS INFORMATION THAT IS PROPRIETARY TO MOLEX INCORPORATED AND SHOULD NOT BE USED WITHOUT WRITTEN PERMISSION					

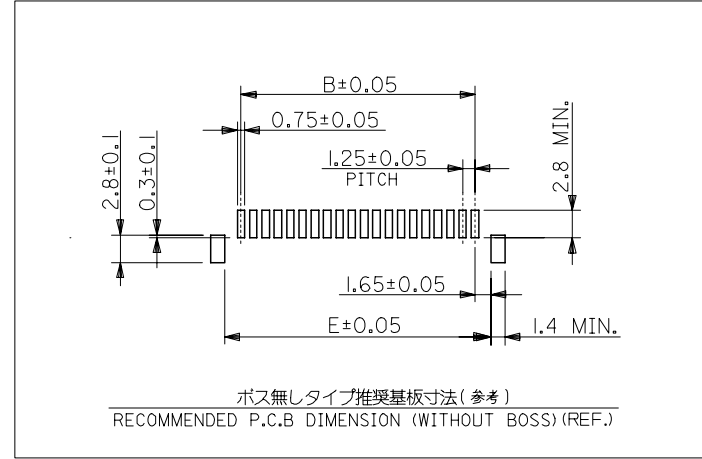
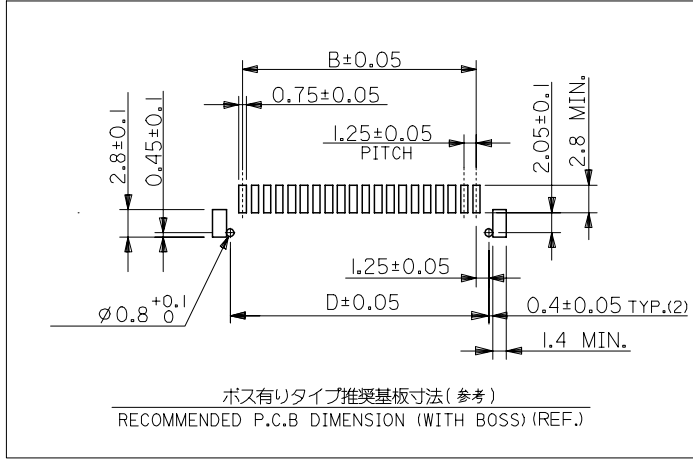

REVISED EC NO: J2007-0566 DRWN: OTANI 2006/09/01 CHK: NUKITA 2006/09/05 APPR: NUKITA 2006/09/08	GENERAL TOLERANCES (UNLESS SPECIFIED)		DIMENSION STYLE MM ONLY		SCALE 4:1	DESIGN UNITS METRIC	THIRD ANGLE PROJECTION	
	10 UNDER	±0.2	DRAWN BY N.AIDA	DATE '05/02/01	TITLE MINI M12 1-ROW SMT WAFER ASS'Y (TIN) -LEAD FREE-			
	10 OVER 30 UNDER	±0.25	CHECKED BY K.TOJO	DATE '05/02/01				
	30 OVER	±0.3	APPROVED BY N.NUKITA	DATE '05/02/01	MOLEX INCORPORATED DOCUMENT NO. SD-55450-010 SHEET NO. 2 OF 2			
	ANGULAR	±3 °	MATERIAL NO. SEE CHART					
DRAFT WHERE APPLICABLE MUST REMAIN WITHIN DIMENSIONS		SIZE A3		THIS DRAWING CONTAINS INFORMATION THAT IS PROPRIETARY TO MOLEX INCORPORATED AND SHOULD NOT BE USED WITHOUT WRITTEN PERMISSION				

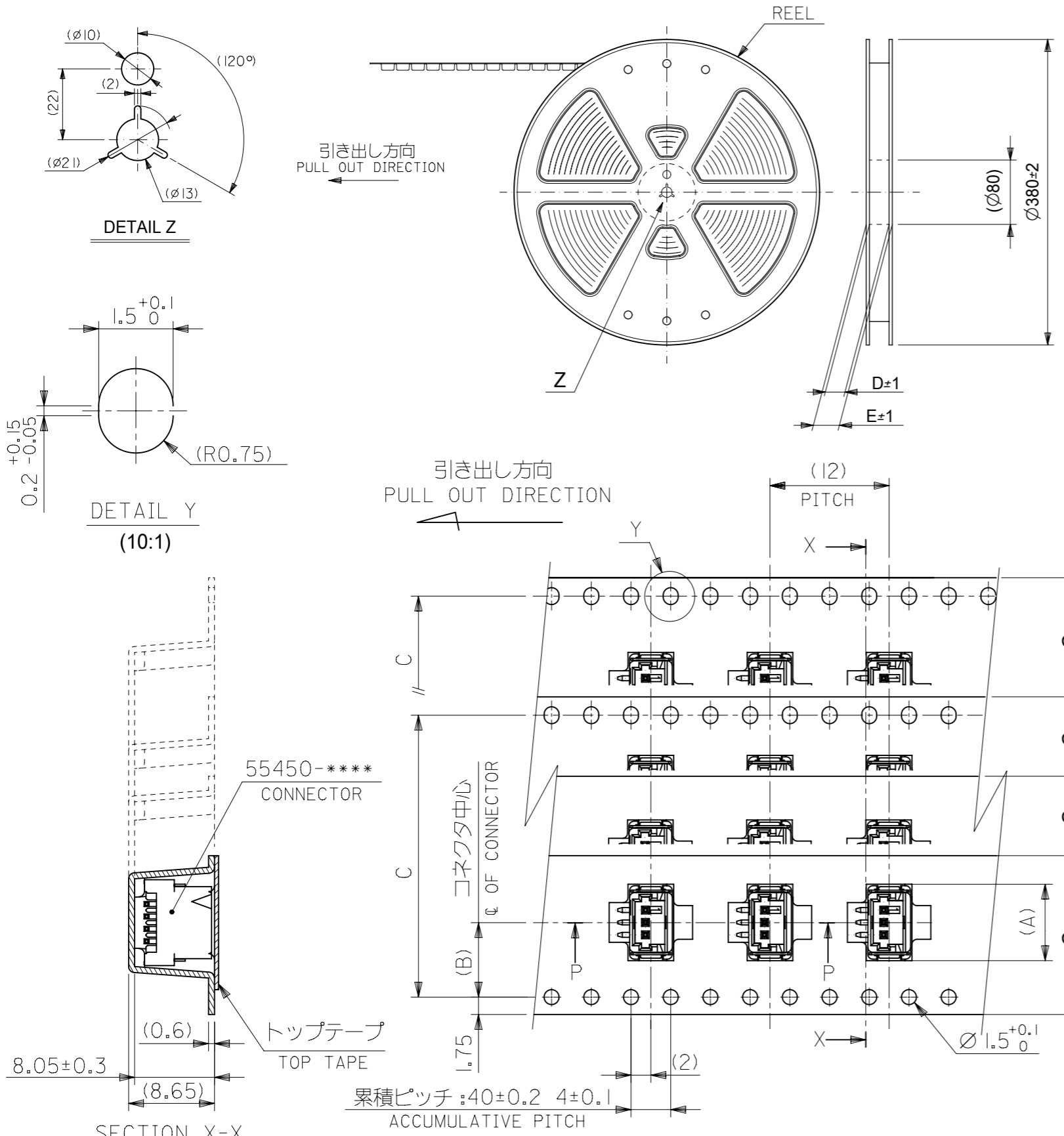

注)
NOTES

1. 製品番号 55450-**** の詳細寸法については、SD-55450-010 を参照下さい。
IN THE PACKAGE , PART NO. 55450-**** DETAILED DIMENSIONS , SEE SD-55450-010.
2. 梱包数量 : 880個/リール
NUMBER OF CONNECTORS : 880 PCS/REEL
3. リードテープ長さ
LEAD TAPE LENGTH

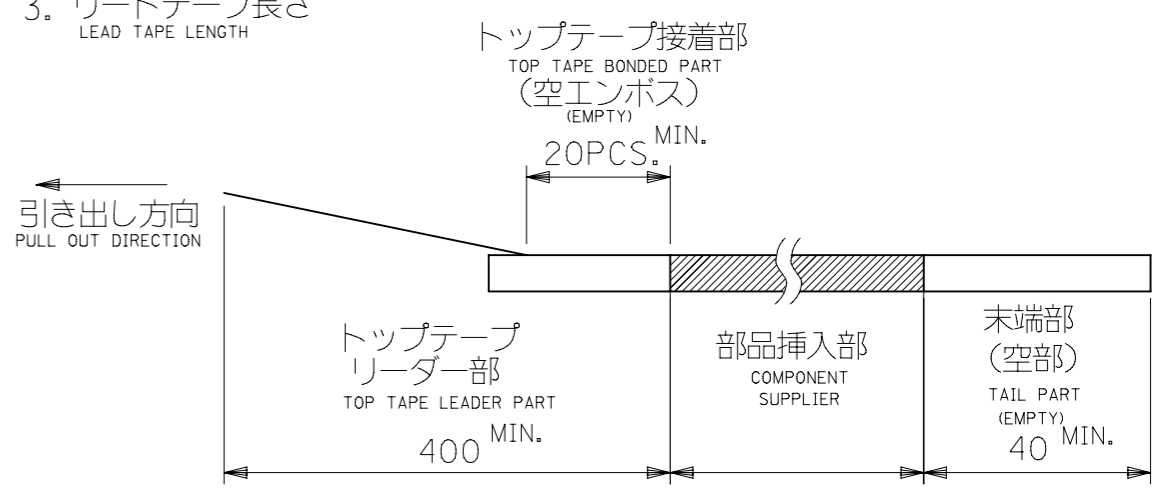

4. トップテープの剥離強度 (剥離方向は下図参照)
PEELING OFF FORCE OF TOP TAPE (PEELING DIRECTION AS SHOWN IN FOLLOWING FIG.)
0.1 ~ 1.3N { 10 ~ 130gf }

尚、本規格値は、出荷時に適用。
THIS REQUIREMENT SHOULD BE APPLIED AT SHIPMENT
(但し、輸送時に剥離が発生しない事。)
(PEEL OFF SHOULD NOT BE ALLOWED, DURING TRANSPORTATION)

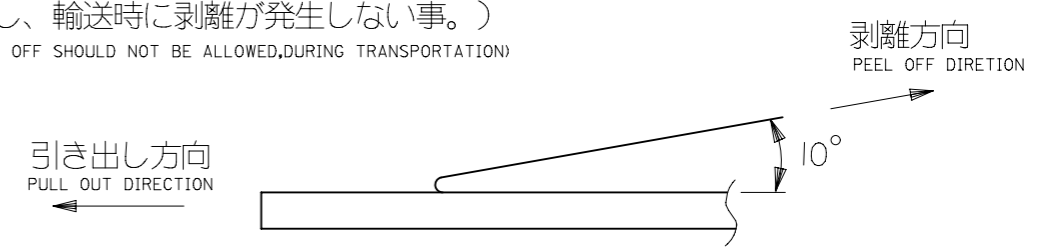

5. 材料
MATERIAL
キャリアテープ : ポリプロピレン (PP)
CARRIER TAPE : POLYPROPYLENE (PP)
トップテープ : PET, PE, PEF
TOP TAPE : PET, PE, PEF
リール : ポリスチレン
REEL : POLYSTYRENE

6. テープ巾32, 44mmに適用。
THIS DIMENSION SHOULD BE APPLIED AT TAPE WIDTH OF 32, 44mm

7. 本製品は 55450-**19/**39/**79/**89 の鉛フリー品である。
THIS PRODUCT IS LEAD FREE OF 55450-**19/**39/**79/**89.

THIS DRAWING CONTAINS INFORMATION THAT IS PROPRIETARY TO MOLEX ELECTRONIC TECHNOLOGIES, LLC AND SHOULD NOT BE USED WITHOUT WRITTEN PERMISSION		CURRENT REV DESC: OBSOLETE PART NO		molex	
DIMENSION UNITS	SCALE				
mm	NTS			EMBOSSED TAPE PACKAGE FOR 55450-**** -LEAD FREE-	
GENERAL TOLERANCES (UNLESS SPECIFIED)				PRODUCT CUSTOMER DRAWING	
				DOCUMENT NUMBER	
				SD-55450-011	
				DOC TYPE	
				PSD	
				DOC PART	
				001	
				REVISION	
				B	
DRAFT WHERE APPLICABLE MUST REMAIN WITHIN DIMENSIONS		THIRD ANGLE PROJECTION	DRAWING	SERIES	MATERIAL NUMBER
			A3-SIZE	55450	SEE TABLE
					CUSTOMER
					GENERAL MARKET
					SHEET NUMBER
					1 OF 3

F
E
D
C
B
A

44	3	49.4	45.4	40.4	20.2	28.95	55450-2060	55450-2069	55450-2050	55450-2050	55450-2059	20	OK			
						27.7	▲ -1960	▲ -1969		▲ -1950	▲ -1959		19	NO		
						26.45	-1860	-1869		-1850	-1859		18	OK		
						25.2	-1760	-1769		-1750	-1759		17	NO		
						23.95	-1660	-1669		-1650	-1659		16	OK		
						22.7	-1560	-1569		-1550	-1559		15	OK		
						21.45	-1460	-1469		-1450	-1459		14	OK		
32	2	37.4	33.4	28.4	14.2	20.2	-1360	-1369	55450-2050	-1350	-1359	55450-2059	-1350	-1359	13	OK
						18.95	-1260	-1269		-1250	-1259		12	OK		
						17.7	-1160	vo -1169		-1150	-1159		11	OK		
						16.45	-1060	-1069		-1050	-1059		10	OK		
24	2	29.4	25.4	—	11.5	15.2	-0960	-0969	55450-2050	-0950	-0959	55450-2059	-0950	-0959	9	NO
						13.95	-0860	-0869		-0850	vo -0859		8	OK		
						12.7	-0760	-0769		-0750	-0759		7	OK		
						11.45	-0660	-0669		-0650	-0659		6	OK		
						10.2	-0560	-0569		-0550	-0559		5	OK		
16	2	21.4	17.4	—	7.5	8.95	-0460	-0469	55450-2050	-0450	-0459	55450-2059	-0450	-0459	4	NO
						7.7	▼ -0360	▼ -0369		▼ -0350	▼ -0359		3	OK		
						6.45	55450-0260	55450-0269		55450-0250	55450-0259		2	OK		
G キャリアテープ巾 TAPE WIDTH	F	E	(D)	C	(B)	(A)	CONNECTOR	エンボス梱包品 製品番号 MATERIAL NO.	MODEL NO.	CONNECTOR	エンボス梱包品 製品番号 MATERIAL NO.	MODEL NO.	極数 CIRCUIT SIZE	量産対応 AVAILABLE		

55450-**69
ボス無し
WITHOUT BOSS

55450-**59
ボス有り
WITH BOSS

THIS DRAWING CONTAINS INFORMATION THAT IS PROPRIETARY TO MOLEX ELECTRONIC TECHNOLOGIES, LLC AND SHOULD NOT BE USED WITHOUT WRITTEN PERMISSION

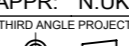
DIMENSION UNITS		SCALE		CURRENT REV DESC: OBSOLETE PART NO	
mm	NTS				
GENERAL TOLERANCES (UNLESS SPECIFIED)					
		MM	INCH	EC NO: 611754	
4 PLACES	±	±	±	DRWN: AKUMAR19	2018/11/30
3 PLACES	±	±	±	CHK'D: GGA	2019/03/26
2 PLACES	±	±	±	APPR: GGA	2019/03/26
1 PLACE	±	±	±	INITIAL REVISION:	
0 PLACES	±	±	±	DRWN: N.AIDA	2005/02/01
ANGULAR TOL	±	°	°	APPR: N.UKITA	2005/02/01
DRAFT WHERE APPLICABLE MUST REMAIN WITHIN DIMENSIONS		THIRD ANGLE PROJECTION		DRAWING	SERIES
				A3-SIZE	55450
DOCUMENT STATUS		P1		RELEASE DATE 2019/03/26 05:13:08	
DOCUMENT NUMBER		SD-55450-011		DOC TYPE DOC PART REVISION	
SEE TABLE		GENERAL MARKET		PSD 001 B	
MATERIAL NUMBER		CUSTOMER		SHEET NUMBER	
2 OF 3		2 OF 3		2 OF 3	

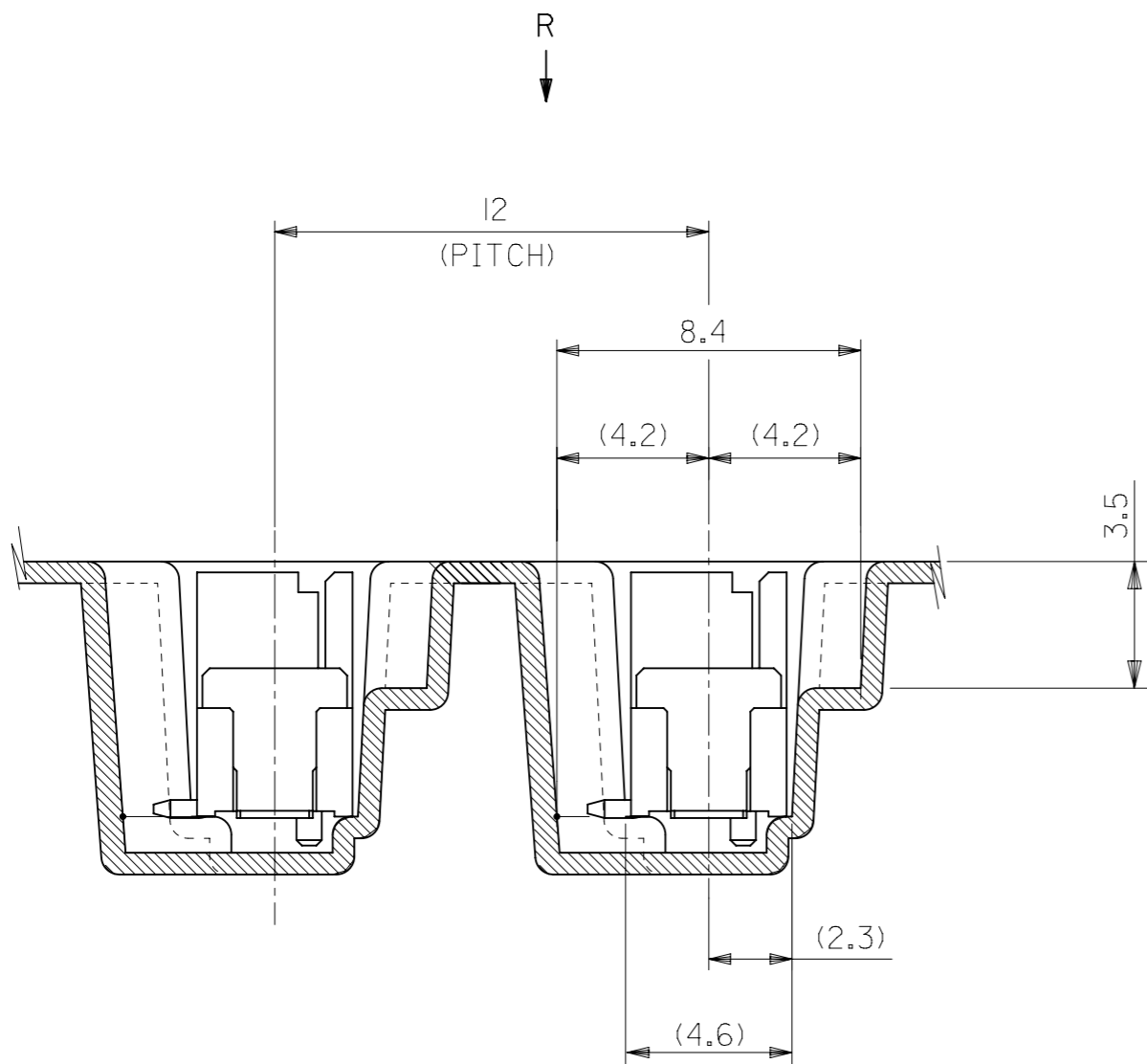

SECTION P-P
(5:1)

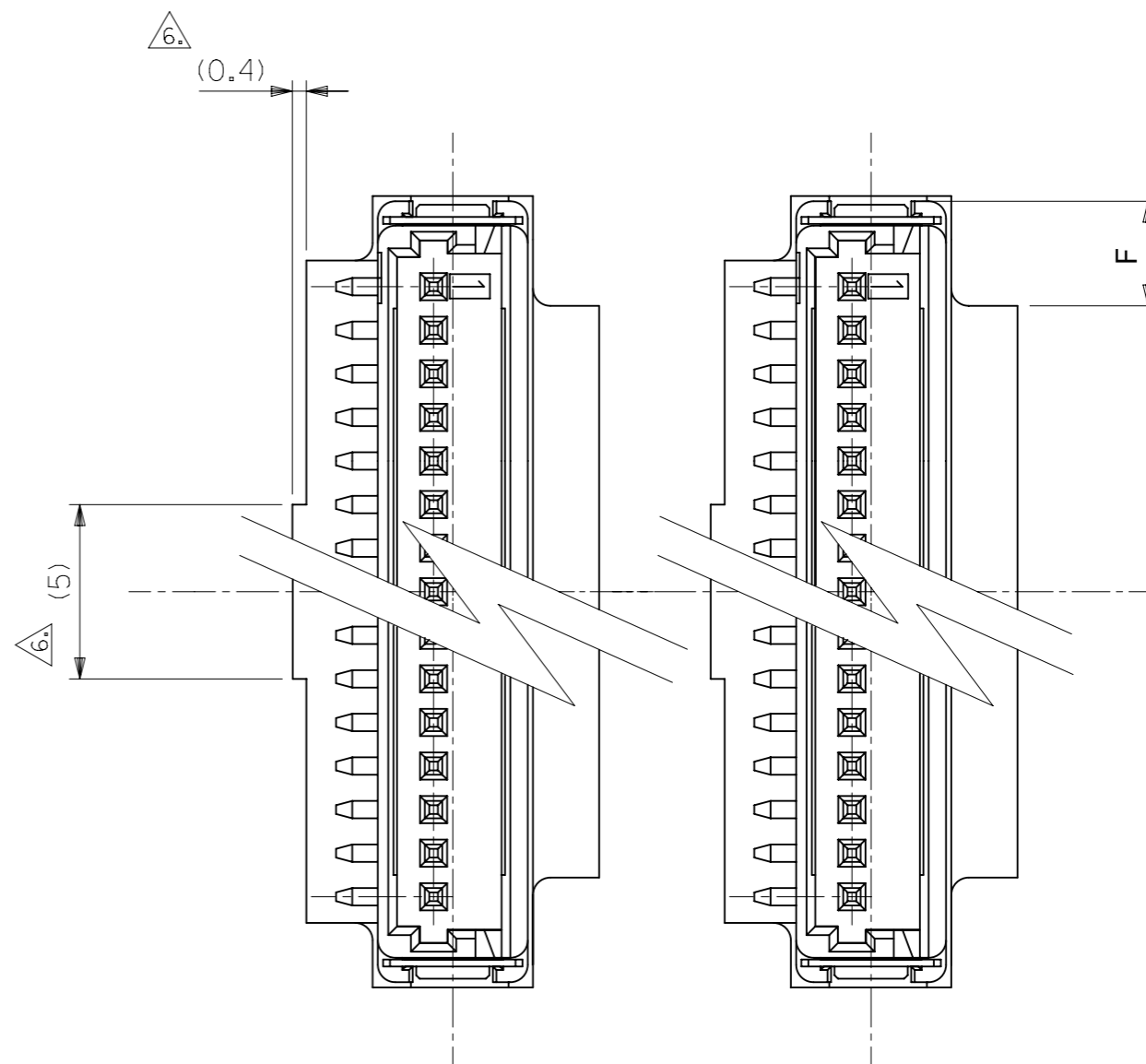

VIEW R
(5:1)

THIS DRAWING CONTAINS INFORMATION THAT IS PROPRIETARY TO MOLEX ELECTRONIC TECHNOLOGIES, LLC AND SHOULD NOT BE USED WITHOUT WRITTEN PERMISSION												
DIMENSION UNITS		SCALE		CURRENT REV DESC: OBSOLETE PART NO						molex		
mm		NTS										
GENERAL TOLERANCES (UNLESS SPECIFIED)				EC NO: 611754		2018/11/30		EMBOSSSED TAPE PACKAGE FOR 55450-**** -LEAD FREE-				
				DRWN: AKUMAR19		2019/03/26						
				CHK'D: GGA		2019/03/26						
				APPR: GGA		2019/03/26		PRODUCT CUSTOMER DRAWING				
				INITIAL REVISION:				DOCUMENT NUMBER		DOC TYPE	DOC PART	REVISION
				DRWN: N.AIDA		2005/02/01		SD-55450-011		PSD	001	B
				APPR: N.UKITA		2005/02/01		MATERIAL NUMBER		CUSTOMER		SHEET NUMBER
				ANGULAR TOL ± °				SEE TABLE		GENERAL MARKET		3 OF 3
DRAFT WHERE APPLICABLE MUST REMAIN WITHIN DIMENSIONS				THIRD ANGLE PROJECTION		DRAWING		SERIES		MATERIAL NUMBER		CUSTOMER
						A3-SIZE		55450		SEE TABLE		GENERAL MARKET