

SHT4x

4th Generation, High-Accuracy, Ultra-Low-Power, 16-bit Relative Humidity and Temperature Sensor Platform

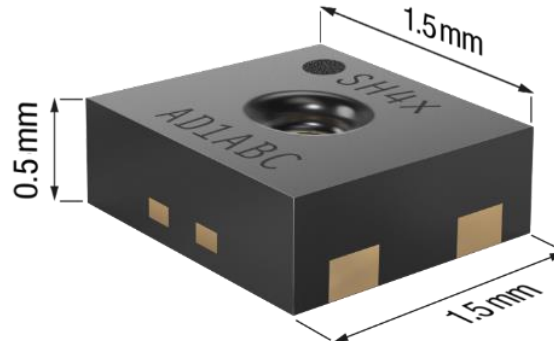

Features

- Relative humidity accuracy: up to ± 1.5 %RH
- Temperature accuracy: up to ± 0.1 °C
- Supply voltage: 1.08 V ... 3.6 V
- Average current: 0.4 μ A (at meas. rate 1 Hz)
- Idle current: 80 nA
- I2C fast mode plus, CRC checksum
- Operating range: 0...100 %RH, -40...125 °C
- Fully functional in condensing environment
- Variable power heater
- NIST traceability
- JEDEC JESD47 qualification
- Mature technology from global market leader

General Description

SHT4x is a digital sensor platform for measuring relative humidity and temperature at different accuracy classes. The I2C interface provides several preconfigured I2C addresses and maintains an ultra-low power budget. The power-trimmed internal heater can be used at three heating levels thus enabling sensor operation in demanding environments. The four-pin dual-flat-no-leads package is suitable for surface mount technology (SMT) processing.

Device Overview

Products	Details
SHT40-AD1B	base RH&T accur., 0x44 I2C addr.
SHT40-BD1B	base RH&T accur., 0x45 I2C addr.
SHT41-AD1B	Intermed. RH&T accur., 0x44 I2C addr.
SHT45-AD1B	± 1.5 %RH, ± 0.1 °C accur., 0x44 I2C addr.

Full product list on page 14

Functional Block Diagram

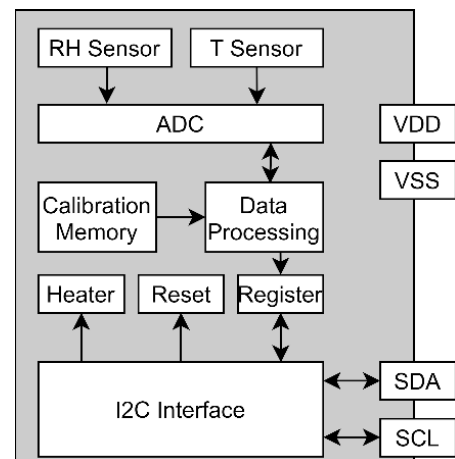

Contents

Features 1

General Description 1

Device Overview 1

Functional Block Diagram 1

1 Quick Start – Hello World 3

2 Humidity and Temperature Sensor Specifications 4

 2.1 Relative Humidity 4

 2.2 Temperature 5

 2.3 Recommended Operating Conditions 6

3 Electrical Specifications 6

 3.1 Electrical Characteristics 7

 3.2 Timings 7

 3.3 Absolute Maximum Ratings 8

4 Sensor Operation 8

 4.1 I2C communication 8

 4.2 Data type & length 9

 4.3 Checksum Calculation 9

 4.4 Command Overview 10

 4.5 Conversion of Signal Output 10

 4.6 Serial number 10

 4.7 Reset 10

 4.8 Heater Operation 11

5 Physical Specification 11

 5.1 Package Description 11

 5.2 Package Outline 12

 5.3 Land Pattern 12

 5.4 Pin Assignment & Laser Marking 13

 5.5 Thermal Information 13

6 Quality and Material Contents 13

7 Tape and Reel Packaging 13

8 Product Name Nomenclature 14

9 Ordering Information 15

10 Bibliography 15

11 Revision History 15

1 Quick Start – Hello World

A typical application circuit for SHT4x is shown on the left-hand side of **Figure 1**. After reaching the minimal supply voltage and allowing for the maximal power-up time of 1 ms the sensor is ready for I2C communication. The quickest way to measure humidity and temperature is pseudo-coded on the right-hand side of **Figure 1**. Together with the conversion formulae given in equations (1), (2), and (3), the digital signals can be translated into relative humidity and temperature readings.

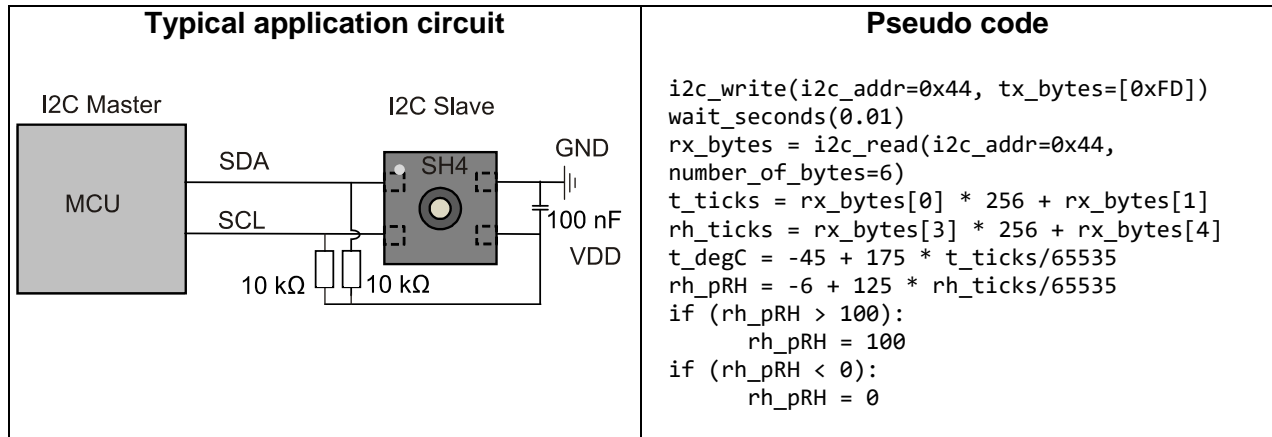

Figure 1: Typical application circuit (left) and pseudo code (right) for easy starting. For details on the signal cropping in the last four lines see **section 4.5**.

Find code resources and embedded drivers on: <https://github.com/Sensirion/embedded-sht/releases>



CAD files can be downloaded from SnapEDA: <https://www.snapeda.com/parts/SHT40-AD1B-R3/Sensirion/view-part/>



2 Humidity and Temperature Sensor Specifications

2.1 Relative Humidity

Parameter	Conditions	Value	Units
SHT40 RH accuracy ¹	typ.	±1.8	%RH
	max.	see Figure 2	-
SHT41 RH accuracy ¹	typ.	±1.8	%RH
	max.	See Figure 3	-
SHT45 RH accuracy ¹	typ.	±1.5	%RH
	max.	tbd	-
Repeatability ²	high	0.08	%RH
	medium	0.15	%RH
	low	0.25	%RH
Resolution ³	-	0.01	%RH
Hysteresis	-	±1	%RH
Specified range ⁴	extended ⁵	0 to 100	%RH
Response time ⁶	$t_{63\%}$	6	s
Long-term drift ⁷	typ.	<0.25	%RH/y

Table 1: General relative humidity sensor specifications.

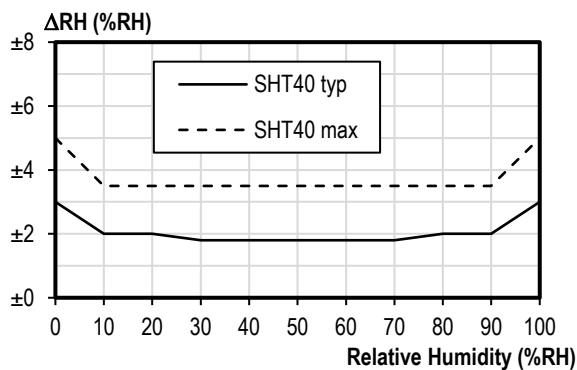

Figure 2: SHT40 typical and maximal relative humidity accuracy at 25 °C.

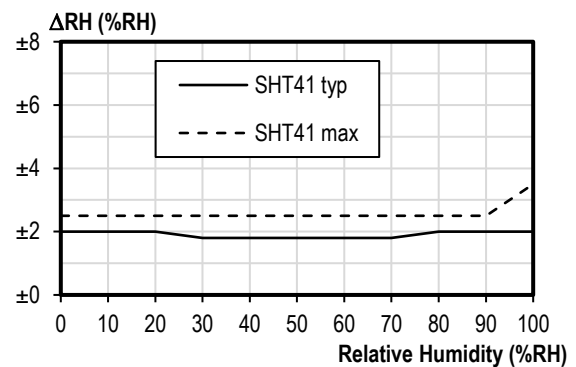

Figure 3: SHT41 typical and maximal relative humidity accuracy at 25 °C.

¹ For definition of typ. and max. accuracy, please refer to the document "Sensirion Humidity Sensor Specification Statement".

² The stated repeatability is 3 times the standard deviation (3σ) of multiple consecutive measurement values at constant conditions and is a measure for the noise on the physical sensor output. Different repeatability commands are listed in Table 7.

³ Resolution of A/D converter.

⁴ Specified range refers to the range for which the humidity or temperature sensor specification is guaranteed.

⁵ For details about recommended humidity and temperature operating range, please refer to section 2.3.

⁶ Time for achieving 63% of a humidity step function, measured at 25°C and 1 m/s airflow. Humidity response time in the application depends on the design-in of the sensor.

⁷ Typical value for operation in normal RH/T operating range. Max. value is < 0.5 %RH/y. Value may be higher in environments with vaporized solvents, out-gassing tapes, adhesives, packaging materials, etc. For more details please refer to Handling Instructions.

Relative Humidity Accuracy at the Extended Temperature Range

The typical RH accuracy tolerances in the range of T=0°C ... 80 °C are given in **Figure 6** and **Figure 7**.

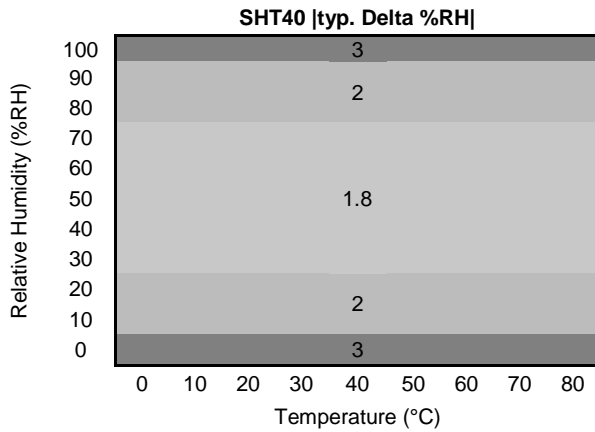

Figure 4: Typical RH accuracy tolerance over humidity and temperature for SHT40.

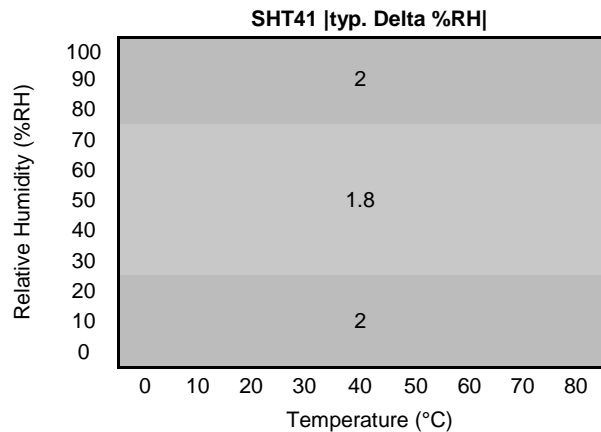

Figure 5: Typical RH accuracy tolerance over humidity and temperature for SHT41.

2.2 Temperature

Parameter	Conditions	Value	Units
SHT40 T Accuracy ¹	typ.	±0.2	°C
	max.	see Figure 6	-
SHT41 T Accuracy ¹	typ.	±0.2	°C
	max.	See Figure 7	-
SHT45 T Accuracy ¹	typ.	±0.1	°C
	max.	tbd	-
Repeatability ²	high	0.04	°C
	medium	0.07	°C
	low	0.1	°C
Resolution ³	-	0.01	°C
Specified range ⁴	-	-40 to +125	°C
Response time ⁸	t _{63%}	2	s
Long-term drift ⁹	typ.	<0.03	°C/y

Table 2: General temperature sensor specifications.

⁸ Temperature response time depends on heat conductivity of sensor substrate and design-in of sensor in application.

⁹ Max. value is < 0.04°C/y.

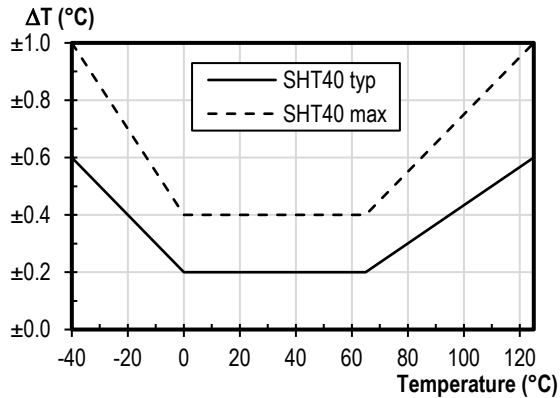

Figure 6: SHT40 typical and maximal temperature accuracy.

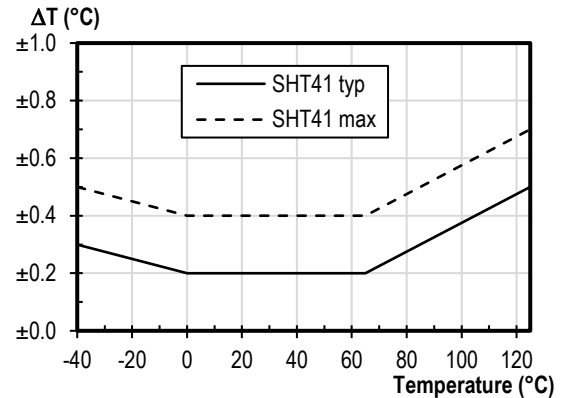

Figure 7: SHT41 typical and maximal temperature accuracy.

2.3 Recommended Operating Conditions

The sensor shows best performance when operated within the recommended normal temperature and humidity range of 5 °C ... 60 °C and 20 %RH ... 80 %RH, respectively. Long term exposure to conditions outside recommended normal range, especially at high relative humidity, may temporarily offset the RH signal (e.g. +3 %RH after 60 h at > 80 %RH). After returning into the recommended normal temperature and humidity range the sensor will recover to within specifications by itself. Prolonged exposure to extreme conditions may accelerate ageing.

To ensure stable operation of the humidity sensor, the conditions described in the document (Sensirion, 2020) regarding exposure to volatile organic compounds have to be met. Please note as well that this does apply not only to transportation and manufacturing, but also to operation of the SHT4x.

3 Electrical Specifications

Valid for all electrical specifications: Typical values correspond to $V_{DD} = 3.3 \text{ V}$ and $T = 25 \text{ °C}$. Min. and max. values are valid in the full temperature range $-40 \text{ °C} \dots 125 \text{ °C}$ and at declared V_{DD} levels.

3.1 Electrical Characteristics

Parameter	Symbol	Conditions	Min	Typ.	Max	Units	Comments
Supply voltage	V_{DD}		1.08	3.3	3.6	V	-
Power-up/down level	V_{POR}	Static power supply	0.6	-	1.08	V	-
Supply current (no heater)	I_{DD}	Idle state	-	0.08	-	μA	-
		Measurement	-	350	-	μA	Average current consumption while sensor is measuring
		Aver., high repeatability Aver., med. repeatability Aver., low repeatability	- - -	2.3 1.2 0.4	- - -	μA	Aver. current consumpt. (contin. operation with one meas. per second)
Power consumpt. at $V_{DD}=1.2V$ (no heater)	-	Aver., high repeatability Aver., med. repeatability Aver., low repeatability	- - -	2.8 1.4 0.5	- - -	μW	Aver. power consumpt. (contin. operation with one meas. per second)
Low level input voltage	V_{IL}	-	0	-	$0.3^* V_{DD}$	V	-
High level input voltage	V_{IH}	-	$0.7^* V_{DD}$	-	V_{DD}	V	-
Pull up resistors	R_p	$V_{DD} < 1.62 V$	820	-	-	Ω	-
		$V_{DD} \geq 1.62 V$	390	-	-	Ω	-
Low level output voltage	V_{OL}	$V_{DD} < 1.62V$, $R_{pullup} > 820 \Omega$	-	-	$0.2^* V_{DD}$	V	-
		$V_{DD} = 1.62V \dots 2.0V$, $R_{pullup} > 390 \Omega$	-	-	$0.2^* V_{DD}$	V	-
		$V_{DD} > 2.0V$, $R_{pullup} > 390 \Omega$	-	-	0.4	V	-
Cap bus load	C_b	$R_p \leq 820 \Omega$: fast mode	-	-	400	pF	Capac. bus load can be determined from $C_b < t_{rise} / (0.8473 * R_p)$. Rise times are $t_{rise} = 300 \text{ ns}$ for fast mode and $t_{rise} = 120 \text{ ns}$ for fast mode plus
		$R_p = 390 \Omega$, $V_{DD} > 1.62 V$: fast mode plus	-	-	340	pF	

Table 3: Electrical specifications.

3.2 Timings

Max. values are measured at $-40^\circ C$ and 1.08 V supply voltage (based on characterization).

Parameter	Symbol	Conditions	Min.	Typ.	Max.	Units	Comments
Power-up time	t_{PU}	After hard reset, $V_{DD} \geq V_{POR}$	-	0.3	1	ms	Time between V_{DD} reaching V_{POR} and sensor entering idle state
Soft reset time	t_{SR}	After soft reset	-	-	1	ms	Time between ACK of soft reset command and sensor entering idle state. Also valid for I2C general call reset.
Waiting time	t_W	between I2C commands	1	-	-	ms	minimal waiting time for I2C communication
Measurement duration	$t_{MEAS,l}$	Low repeatability	-	1.3	1.7	ms	The three repeatability modes differ with respect to measurement duration, noise level and energy consumption
	$t_{MEAS,m}$	Med. repeatability	-	3.7	4.5	ms	
	$t_{MEAS,h}$	High repeatability	-	6.9	8.2	ms	
Heater-on duration	t_{Heater}	Long pulse	0.9	1	1.1	s	After that time the heater is automatically switched off
		Short pulse	0.09	0.1	0.11	s	After that time the heater is automatically switched off

Table 4 System timing specifications.

3.3 Absolute Maximum Ratings

Stress levels beyond those listed in Table 5 may cause permanent damage or affect the reliability of the device. These are stress ratings only and functional operation of the device at these conditions is not guaranteed. Ratings are only tested each at a time.

Parameter	Rating
Max. voltage on any pin	$V_{SS} - 0.3\text{ V} \dots V_{DD} + 0.3\text{ V}$
Operating temperature range	-40 °C ... 125 °C
Storage temperature range ¹⁰	-40 °C ... 150 °C
ESD HBM	2 kV
ESD CDM	500 V
Latch up, JEDEC Class II, 125°C	+/-100 mA

Table 5: Absolute maximum ratings.

4 Sensor Operation

4.1 I2C communication

I2C communication is based on NXP's I2C-bus specification and user manual UM10204, Rev.6, 4 April 2014. Supported I2C modes are standard, fast mode, and fast mode plus. Data is transferred in multiples of 16-bit words and 8-bit check sum (cyclic redundancy check = CRC). All transfers must begin with a start condition (S) and terminate with a stop condition (P). To finish a read transfer, send not acknowledge (NACK) and stop condition (P). Addressing a specific slave device is done by sending its 7-bit I2C address followed by an eighth bit, denoting the communication

¹⁰ The recommended storage temperature range is 10-50°C. Please consult the document "SHTxx Handling Instructions" for more information.

direction: “zero” indicates transmission to the slave, i.e. “write”, a “one” indicates a “read” request. Schematics of the I2C transfer types are sketched in **Figure 8**.

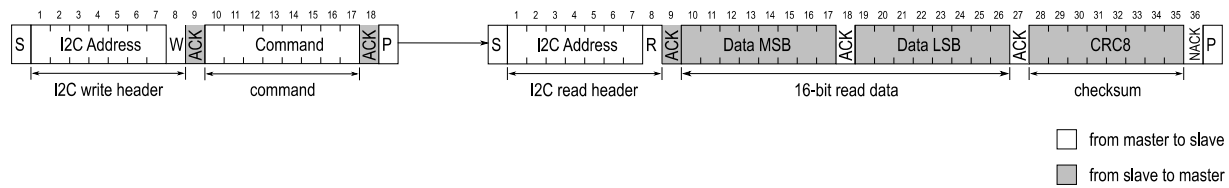

Figure 8: I2C transfer types: First a write header is sent to the I2C slave, followed by a command, for example “measure RH&T with highest precision”. After the measurement is finished the read request directed to this I2C slave will be acknowledged and transmission of data will be started by the slave.

4.2 Data type & length

I2C bus operates with 8-bit data packages. Information from the sensor to the master has a checksum after every second 8-bit data package.

Humidity and temperature data will always be transmitted in the following way: The first value is the temperature signal (2 * 8-bit data + 8-bit CRC), the second is the humidity signal (2 * 8-bit data + 8-bit CRC).

4.3 Checksum Calculation

For read transfers each 16-bit data is followed by a checksum with the following properties

Property	Value
Name	CRC-8
Message Length	16-bit
Polynomial	0x31 ($x^8 + x^5 + x^4 + 1$)
Initialization	0xFF
Reflect Input/Output	false/false
Final XOR	0x00
Examples	CRC(0xBEEF) = 0x92

Table 6 Data check sum properties.

The master may abort a read transfer after the 16-bit data, if it does not require a checksum.

4.4 Command Overview

Command		Response length incl. CRC (bytes)	Description
bin	hex		
1111 1101	FD	6	measure T & RH with high precision (high repeatability)
1111 0110	F6	6	measure T & RH with medium precision (medium repeatability)
1110 0000	E0	6	measure T & RH with lowest precision (low repeatability)
1000 1001	89	6	read serial
1001 0100	94	-	soft reset
0011 1001	39	6	activate highest heater power & high precis. meas. (typ. 200mW @ 3.3V) for 1s
0011 0010	32	6	activate highest heater power & high precis. meas. (typ. 200mW @ 3.3V) for 0.1s
0010 1111	2F	6	activate medium heater power & high precis. meas. (typ. 110mW @ 3.3V) for 1s
0010 0100	24	6	activate medium heater power & high precis. meas. (typ. 110mW @ 3.3V) for 0.1s
0001 1110	1E	6	activate lowest heater power & high precis. meas. (typ. 20mW @ 3.3V) for 1s
0001 0101	15	6	activate lowest heater power & high precis. meas. (typ. 20mW @ 3.3V) for 0.1s

Table 7 Overview of I2C commands.

4.5 Conversion of Signal Output

The digital sensor signals correspond to following humidity and temperature values:

$$RH = \left(-6 + 125 \cdot \frac{S_{RH}}{2^{16} - 1} \right) \%RH \tag{1}$$

$$T = \left(-45 + 175 \cdot \frac{S_T}{2^{16} - 1} \right) ^\circ C \tag{2}$$

$$T = \left(-49 + 315 \cdot \frac{S_T}{2^{16} - 1} \right) ^\circ F \tag{3}$$

N.B.: The RH conversion formula (1) allows values to be reported which are outside of the range of 0 %RH ... 100 %RH. Relative humidity values which are smaller than 0 %RH and larger than 100 %RH are non-physical, however these “uncropped” values might be found beneficial in some cases (e.g. when the distribution of the sensors at the measurement boundaries are of interest). For all users who don’t want to engage in evaluation of these non-physical values, cropping of the RH signal to the range of 0 %RH ... 100 %RH is advised.

4.6 Serial number

Each and every single sensor has a unique serial number, that is assigned by Sensirion during production. It is stored in the one-time-programmable memory and cannot be manipulated after production. The serial number is accessible via I2C and is transmitted as two 16-bit words, each followed by an 8-bit CRC.

4.7 Reset

A reset of the sensor can be achieved in three ways:

- Soft reset: send the reset command described in **Table 7**.
- I2C general call: all devices on I2C bus are reset by sending the command 0x06 to the I2C address 0x00.
- Power down (incl. pulling SCL and SDA low)

4.8 Heater Operation

The sensor incorporates an integrated on-chip heater which can be switched on by the set of commands given in **Table 7**. There are three different heating powers and two different heating times accessible to the user. After reception of a heater-on command, the sensor executes the following procedure:

1. The heater is enabled and the timer starts its count-down
2. On timer expiration a temperature and humidity measurement with the highest repeatability is started, the heater remains enabled
3. After the measurement is finished the heater is turned off
4. Temperature and humidity values are now available

The maximum on-time of the heater commands is 1 second, in order to prevent overheating of the sensor by unintended usage of the heater. Thus, there is no dedicated command to turn off the heater. For extended heating periods it is required to send periodic heater-on commands, keeping in mind that the heater is designed for a maximal duty cycle of less than 5%. To obtain a fast increase in temperature the idle time between consecutive heating pulses shall be kept minimal.

Possible Heater Use Cases

There will be dedicated Sensirion application notes elaborating on various use cases of the heater. In general, the applications of the on-chip heater range around:

1. Removal of condensed / spray water on the sensor surface. Although condensed water is not a reliability / quality problem to the sensor, it will however make the sensor non-responsive to RH changes in the air as long as there is liquid water on the surface.
2. Creep-free operation in high humid environments. Periodic heating pulses allow for creep-free high-humidity measurements for extended times.

Important notes for operating the heater:

1. The heater is designed for a maximum duty cycle of 5%.
2. During operation of the heater, sensor specifications are not valid.
3. The temperature sensor can additionally be affected by the thermally induced mechanical stress, offsetting the temperature reading from the actual temperature.
4. The sensor's temperature (base temperature + temperature increase from heater) must not exceed $T_{max} = 125\text{ °C}$ in order to have proper electrical functionality of the chip.

If higher heating temperatures are desired, consecutive heating commands have to be sent to the sensor. The heater shall only be operated in ambient temperatures below 65°C else it could drive the sensor outside of its maximal operating temperature.

5 Physical Specification

5.1 Package Description

SHT4x is provided in an open-cavity dual flat no lead (DFN) package. The humidity sensor opening is centered on the top side of the package. The sensor chip is made of silicon, hosted on a copper lead frame and overmolded by an epoxy-based mold compound. Exposed bottom side of the leadframe with the metallic contacts is Ni/Pd/Au coated, side walls are bare copper.

Moisture sensitivity level (MSL) of 1 according to IPC/JEDEC J-STD-020 is achieved. It is recommended to process the sensors within one year after date of delivery.

5.2 Package Outline

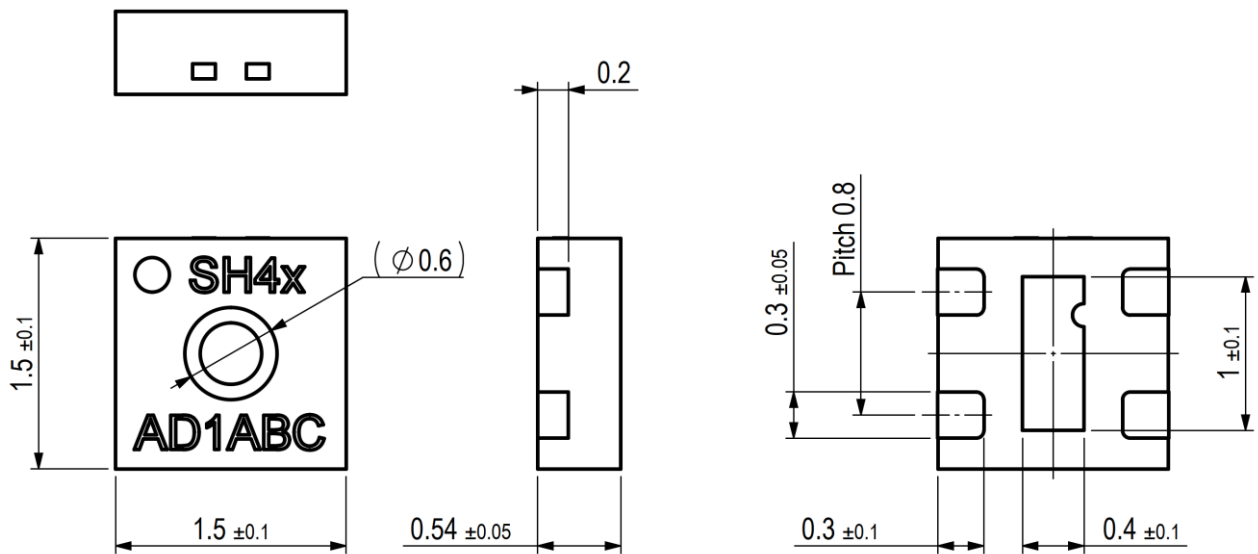

Figure 9 Dimensional drawing of SHT4x including package tolerances (units mm).

5.3 Land Pattern

The land pattern is recommended to be designed according to the used PCB and soldering process together with the physical outer dimensions of the sensor. For reference, the land pattern used with Sensirion’s PCBs and soldering processes is given in **Figure 10**.

Soldering of the central die pad is optional. Sensirion recommends to not solder the central die pad because the sensor can reach higher temperatures upon heater activation.

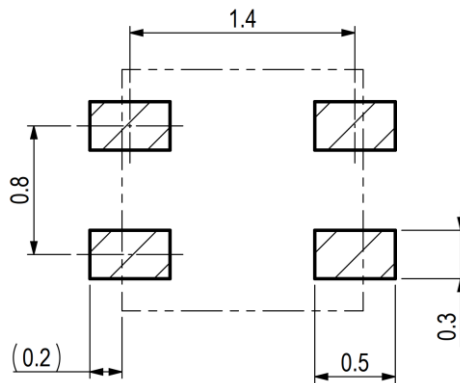

Figure 10: Recommended land pattern (in mm). Details can vary and depend on used PCBs and solder processes. There shall be no copper under the sensor other than at the pin pads.

5.4 Pin Assignment & Laser Marking

Pin	Name	Comments
1	SDA	Serial data, bidirectional
2	SCL	Serial clock, unidirectional input
3	VDD	Supply voltage
4	VSS	Ground

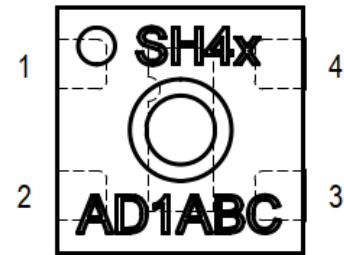

Figure 11 Pin assignment (transparent top view). Dashed lines are only visible if sensor is viewed from below. The die pad is not directly connected to any pin.

The laser marking consists of two lines, indicated in **Figure 11**. In the first line a filled circle serves as pin-1 indicator and is followed by “SH4”. The last character will indicate the accuracy class of this product (here “x” serves as place holder). In the second line, the first three characters specify the product characteristics according to positions 7,8 and 9 of **Table 9**. The second three characters serve as internal batch tracking code.

5.5 Thermal Information

Symbol	Description	Heater off, die pad soldered (K/W)	Heater on, die pad soldered (K/W)	Heater off, die pad not soldered (K/W)	Heater on, die pad not soldered (K/W)
$R_{\theta JA}$	Junction-to-ambient thermal resistance	246	308	297	357
$R_{\theta JC}$	Junction-to-case thermal resistance	189	255	191	257
$R_{\theta JB}$	Junction-to-board thermal resistance	159	225	193	258
Ψ_{JB}	Junction-to-board characterization param.	159	223	191	254
Ψ_{JT}	Junction-to-top characterization param.	38	105	44	112

Table 8 Typical values for thermal metrics. In the “heater on” columns a heater power of 200 mW was assumed. Soldering of the die pad is not recommended, therefore the two right hand side columns are bold. Values are based on simulation.

6 Quality and Material Contents

Qualification of SHT4x is performed based on the JEDEC JESD47 qualification test method. Qualification pending. The device is fully RoHS and WEEE compliant, e.g. free of Pb, Cd, and Hg.

For general remarks of best practice in processing humidity sensor please refer to the handling instructions (Sensirion, 2020).

7 Tape and Reel Packaging

All specifications for the tape and reel packaging can be found on **Figure 12**. Reel diameters are 13 inch and 8 inch for the 10k and the 2.5k packaging sizes, respectively.

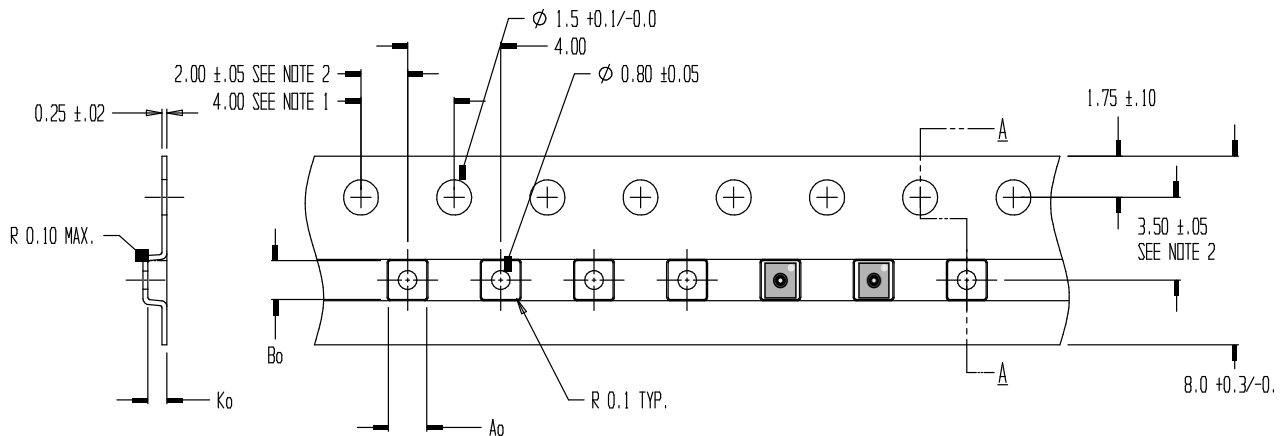

- NOTES:
1. 10 SPROCKET HOLE PITCH CUMULATIVE TOLERANCE ± 0.2
 2. POCKET POSITION RELATIVE TO SPROCKET HOLE MEASURED AS TRUE POSITION OF POCKET, NOT POCKET HOLE
 3. A_o AND B_o ARE CALCULATED ON A PLANE AT A DISTANCE "R" ABOVE THE BOTTOM OF THE POCKET.
- $A_o = 1.65 \pm 0.05$ TOLERANCES - UNLESS
 $B_o = 1.65 \pm 0.05$ NOTED 1PL ± 0.2 2PL ± 0.10
 $K_o = 0.81 \pm 0.05$

Figure 12: Tape and reel specifications including sensor orientation in pocket (see indication of two sensors on the right side of the tape).

8 Product Name Nomenclature

position	value(s)	explanation
1	S	Sensirion
2	H	Humidity Signal
3	T	Temperature Signal
4	4	Fourth product generation
5	0	Base accuracy
	1	Intermediate accuracy
	5	Best accuracy
6	-	delimiter
7	A	I2C interface with 0x44 address
	B	I2C interface with 0x45 address
8	D	DFN package
9	1	reserved
10	B	blank package without membrane
11	-	delimiter
12	R	Tape on reel packaging
13	2	Packaging article contains 2'500 pieces
	3	Packaging article contains 10'000 pieces

Table 9 SHT4x product name nomenclature.

9 Ordering Information

Material Description	Material Number	Details	Quantity (pcs)
SHT40-AD1B-R2	3.000.465	base RH&T accuracy, 0x44 I2C addr.	2'500
SHT40-AD1B-R3	3.000.353	base RH&T accuracy, 0x44 I2C addr.	10'000
SHT40-BD1B-R2	tbd	base RH&T accuracy, 0x45 I2C addr.	2'500
SHT40-BD1B-R3	tbd	base RH&T accuracy, 0x45 I2C addr.	10'000
SHT41-AD1B-R2	3.000.466	Available 2021 intermed. RH&T accuracy, 0x44 I2C addr.	2'500
SHT41-AD1B-R3	tbd	Available 2021 intermed. RH&T accuracy, 0x44 I2C addr.	10'000
SHT45-AD1B-R2	tbd	Available 2021 ±1.5%RH, ±0.1°C acc., 0x44 I2C addr.	2'500
SHT45-AD1B-R3	tbd	Available 2021 ±1.5%RH, ±0.1°C acc., 0x44 I2C addr.	10'000

Table 10 SHT4x ordering options.

10 Bibliography

Sensirion. (2020). *Handling Instructions for Humidity Sensors*. Retrieved from www.sensirion.com

11 Revision History

Date	Version	Page(s)	Changes
October 2020	1	all	Initial release

Important Notices

Warning, Personal Injury

Do not use this product as safety or emergency stop devices or in any other application where failure of the product could result in personal injury. Do not use this product for applications other than its intended and authorized use. Before installing, handling, using or servicing this product, please consult the data sheet and application notes. Failure to comply with these instructions could result in death or serious injury.

If the Buyer shall purchase or use SENSIRION products for any unintended or unauthorized application, Buyer shall defend, indemnify and hold harmless SENSIRION and its officers, employees, subsidiaries, affiliates and distributors against all claims, costs, damages and expenses, and reasonable attorney fees arising out of, directly or indirectly, any claim of personal injury or death associated with such unintended or unauthorized use, even if SENSIRION shall be allegedly negligent with respect to the design or the manufacture of the product.

ESD Precautions

The inherent design of this component causes it to be sensitive to electrostatic discharge (ESD). To prevent ESD-induced damage and/or degradation, take customary and statutory ESD precautions when handling this product. See application note "ESD, Latchup and EMC" for more information.

Warranty

SENSIRION warrants solely to the original purchaser of this product for a period of 12 months (one year) from the date of delivery that this product shall be of the quality, material and workmanship defined in SENSIRION's published specifications of the product. Within such period, if proven to be defective, SENSIRION shall repair and/or replace this product, in SENSIRION's discretion, free of charge to the Buyer, provided that:

- notice in writing describing the defects shall be given to SENSIRION within fourteen (14) days after their appearance;
- such defects shall be found, to SENSIRION's reasonable satisfaction, to have arisen from SENSIRION's faulty design, material, or workmanship;
- the defective product shall be returned to SENSIRION's factory at the Buyer's expense; and
- the warranty period for any repaired or replaced product shall be limited to the unexpired portion of the original period.

This warranty does not apply to any equipment which has not been installed and used within the specifications recommended by SENSIRION for the intended and proper use of the equipment. EXCEPT FOR THE WARRANTIES EXPRESSLY SET FORTH HEREIN, SENSIRION MAKES NO WARRANTIES, EITHER EXPRESS OR IMPLIED, WITH RESPECT TO THE PRODUCT. ANY AND ALL WARRANTIES, INCLUDING WITHOUT LIMITATION, WARRANTIES OF MERCHANTABILITY OR FITNESS FOR A PARTICULAR PURPOSE, ARE EXPRESSLY EXCLUDED AND DECLINED.

SENSIRION is only liable for defects of this product arising under the conditions of operation provided for in the data sheet and proper use of the goods. SENSIRION explicitly disclaims all warranties, express or implied, for any period during which the goods are operated or stored not in accordance with the technical specifications.

SENSIRION does not assume any liability arising out of any application or use of any product or circuit and specifically disclaims any and all liability, including without limitation consequential or incidental damages. All operating parameters, including without limitation recommended parameters, must be validated for each customer's applications by customer's technical experts. Recommended parameters can and do vary in different applications.

SENSIRION reserves the right, without further notice, (i) to change the product specifications and/or the information in this document and (ii) to improve reliability, functions and design of this product.

Copyright © 2020, by SENSIRION. CMOSens® is a trademark of Sensirion. All rights reserved

Headquarters and Subsidiaries

Sensirion AG

Laubisruetistr. 50
CH-8712 Staefa ZH
Switzerland

phone: +41 44 306 40 00
fax: +41 44 306 40 30
info@sensirion.com
www.sensirion.com

Sensirion Taiwan Co. Ltd

phone: +886 3 5506701
info@sensirion.com
www.sensirion.com

Sensirion Inc., USA

phone: +1 312 690 5858
info-us@sensirion.com
www.sensirion.com

Sensirion Japan Co. Ltd.

phone: +81 3 3444 4940
info-jp@sensirion.com
www.sensirion.com/jp

Sensirion Korea Co. Ltd.

phone: +82 31 337 7700~3
info-kr@sensirion.com
www.sensirion.com/kr

Sensirion China Co. Ltd.

phone: +86 755 8252 1501
info-cn@sensirion.com
www.sensirion.com/cn

To find your local representative, please visit www.sensirion.com/distributors