



PIDG

TE Internal #: 8-1377174-5

TE Internal Description: SMP 9-0160481-1

[View on TE.com >](#)

Terminals & Splices > Quick Disconnects

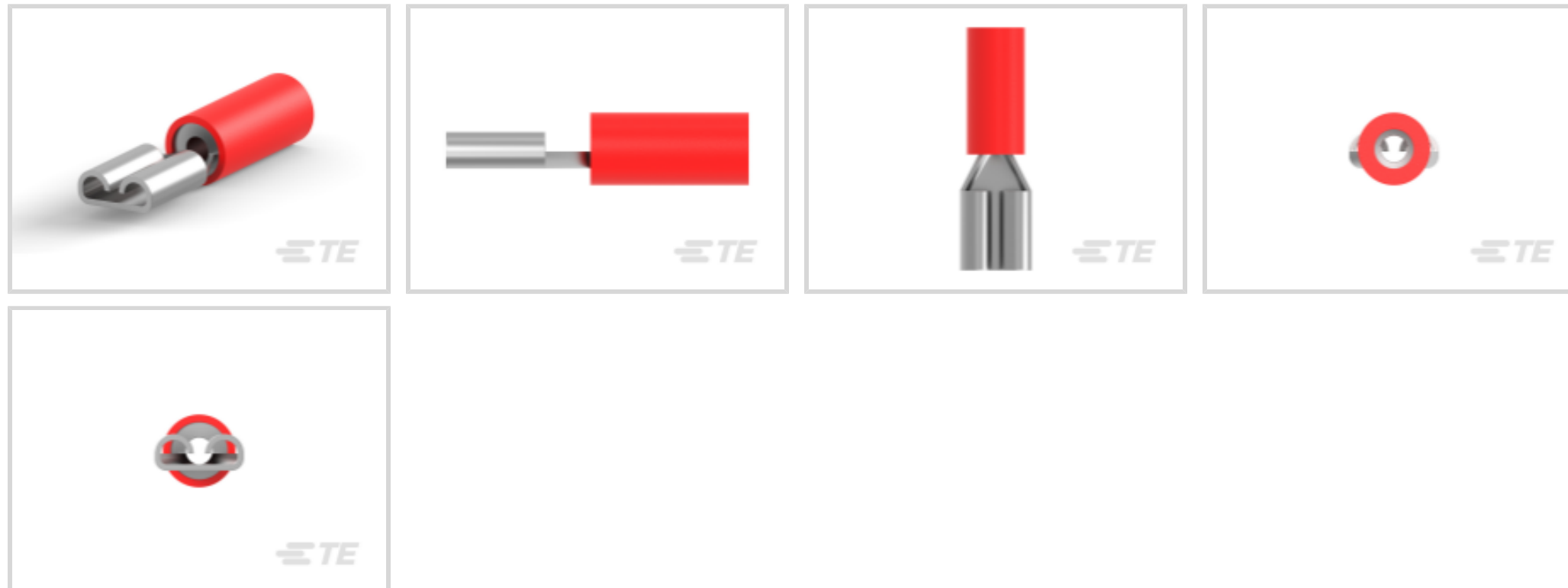

Quick Disconnect Terminal Type: **Receptacle**

Wire Size: **592 – 2960 CMA**

Mating Tab Width: **4.8 mm [.189 in]**

Features

Product Type Features

Insertion Force	Normal
-----------------	--------

Electrical Characteristics

Voltage Rating	300 V
----------------	-------

Body Features

Insulation Material	Nylon
---------------------	-------

Contact Features

Quick Disconnect Terminal Type	Receptacle
Mating Tab Width	4.8 mm [.189 in]
Mating Tab Thickness	.5 mm [.02 in]
Terminal Orientation	Straight
Contact Base Material	Brass
Terminal Plating Material	Tin
Crimp Type	Compression
Barrel Type	Closed

Mechanical Attachment

Wire Insulation Support	With
-------------------------	------

Dimensions

Compatible Insulation Diameter Range	3.5 mm[.14 in]
Wire Size	592 – 2960 CMA

Usage Conditions

Insulation Option	Partially Insulated
Operating Temperature Range	105 °C[221 °F]

Packaging Features

Packaging Quantity	50
Packaging Method	Box

Other

Barrel Color	Red
--------------	-----

Product Compliance

[For compliance documentation, visit the product page on TE.com>](#)

EU RoHS Directive 2011/65/EU	Compliant
EU ELV Directive 2000/53/EC	Compliant
China RoHS 2 Directive MIIT Order No 32, 2016	No Restricted Materials Above Threshold
EU REACH Regulation (EC) No. 1907/2006	Current ECHA Candidate List: JUNE 2024 (241) Candidate List Declared Against: JAN 2024 (240) Does not contain REACH SVHC
Halogen Content	Low Halogen - Br, Cl, F, I < 900 ppm per homogenous material. Also BFR/CFR/PVC Free
Solder Process Capability	Not applicable for solder process capability

Product Compliance Disclaimer

This information is provided based on reasonable inquiry of our suppliers and represents our current actual knowledge based on the information they provided. This information is subject to change. The part numbers that TE has identified as EU RoHS compliant have a maximum concentration of 0.1% by weight in homogenous materials for lead, hexavalent chromium, mercury, PBB, PBDE, DBP, BBP, DEHP, DIBP, and 0.01% for cadmium, or qualify for an exemption to these limits as defined in the Annexes of Directive 2011/65/EU (RoHS2). Finished electrical and electronic equipment products will be CE marked as required by Directive 2011/65/EU. Components may not be CE marked. Additionally, the part numbers that TE has identified as EU ELV compliant have a maximum concentration of 0.1% by weight in homogenous materials for lead, hexavalent chromium, and mercury, and 0.01% for cadmium, or qualify for an exemption to these limits as defined in the Annexes of Directive 2000/53/EC (ELV). Regarding the REACH Regulation, the information TE provides on SVHC in articles for this part number is based on the latest European Chemicals Agency (ECHA) 'Guidance on requirements for substances in articles' posted at this URL: <https://echa.europa.eu/guidance-documents/guidance-on-reach>

Compatible Parts



TE Part # 9-160481-1
4,8 PIDG FASTON REC



TE Part # 1SET162015R0000

Also in the Series | PIDG



Compression Connectors(17)



Crimp Wire Pins, Tabs & Ferrules(41)



Hand Crimping Tools(2)



Knife Disconnects(11)

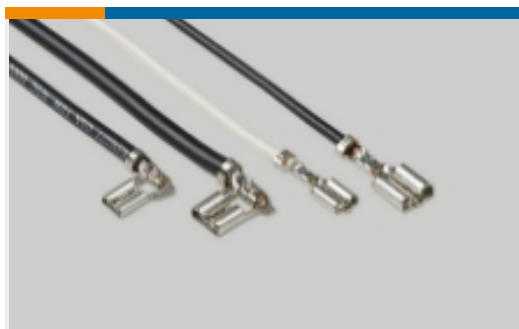

Quick Disconnects(32)



Ring Terminals(589)

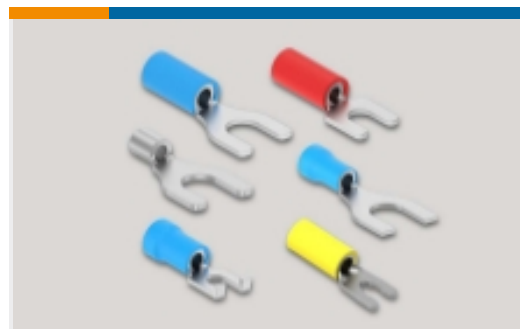

Spade Terminals(228)



Special Purpose Terminals(1)



Splices(40)

Customers Also Bought



TE Part #206708-1
CPC PLUG ASSEMBLY SIZE 13-9

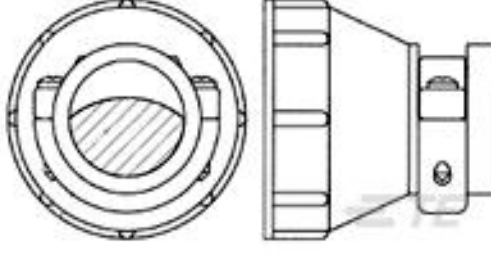

TE Part #182663-1
13 SIZE CPC STD CLAMP



TE Part #5-1462037-4
IM41GR=IM RELAY 100mW 3V BIS



TE Part #52934
TERMINAL,PIDG SPR SPD 16-14 5



TE Part #1625959-7
HB03RE 1G0 1% 100PPM



TE Part #1577647-1
TERMINAL RT PIDG PEEK STRATO 10 AWG



TE Part #7-1676481-6
CPF 0603 9K1 0.1% 25PPM 1K RL



TE Part #2-320568-1
TERMINAL,PIDG R 12-10 8

Documents

Product Drawings

[SMP 9-0160481-1](#)

English

CAD Files

[3D PDF](#)

3D

Customer View Model

[ENG_CVM_CVM_8-1377174-5_C1.2d_dxf.zip](#)

English

Customer View Model

[ENG_CVM_CVM_8-1377174-5_C1.3d_igs.zip](#)

English

Customer View Model

[ENG_CVM_CVM_8-1377174-5_C1.3d_stp.zip](#)

English

By downloading the CAD file I accept and agree to the [Terms and Conditions](#) of use.