

## LM78Mxx Precision 500 mA regulators

### Features

- Output current to 0.5 A
- Output voltages of 5; 6; 8; 9; 10; 12; 15; 24 V
- Thermal overload protection
- Short circuit protection
- Output transition SOA protection
- $\pm 2\%$  output voltage tolerance
- Guaranteed in extended temperature range

### Description

The LM78Mxx series of three-terminal positive regulators is available in DPAK . packages and with several fixed output voltages, making it useful in a wide range of applications. These regulators can provide local on-card regulation eliminating the distribution problems associated with single point regulation. Each type employs internal current limiting, thermal shutdown and safe area protection, making it essentially indestructible. If adequate heat sinking is provided, they can deliver over 0.5 A output current. Although designed primarily as fixed voltage regulators, these devices can be used with external components to obtain adjustable voltage and currents.

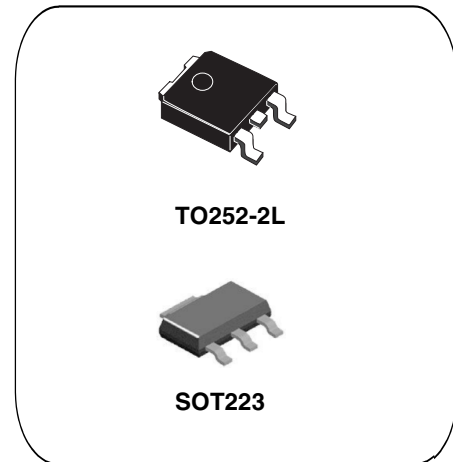

### PIN CONFIGURATION

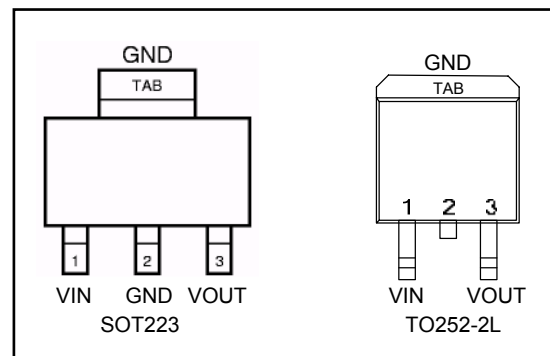
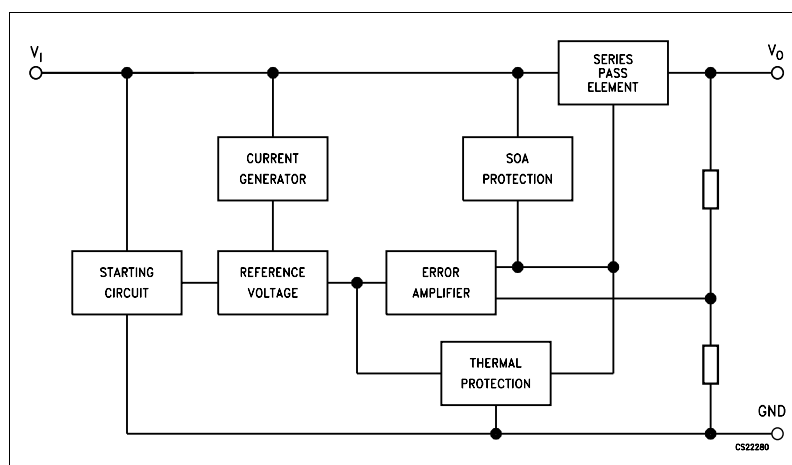

Figure 1. Block diagram



## ORDERING INFORMATION

DEVICE	Package Type	MARKING	Packing	Packing Qty
LM78M05CDT/TR	TO252-2L	LM78M05	REEL	2500pcs/reel
LM78M06CDT/TR	TO252-2L	LM78M06	REEL	2500pcs/reel
LM78M08CDT/TR	TO252-2L	LM78M08	REEL	2500pcs/reel
LM78M09CDT/TR	TO252-2L	LM78M09	REEL	2500pcs/reel
LM78M10CDT/TR	TO252-2L	LM78M10	REEL	2500pcs/reel
LM78M12CDT/TR	TO252-2L	LM78M12	REEL	2500pcs/reel
LM78M15CDT/TR	TO252-2L	LM78M15	REEL	2500pcs/reel
LM78M24CDT/TR	TO252-2L	LM78M24	REEL	2500pcs/reel
LM78M05IDT/TR	TO252-2L	LM78M05	REEL	2500pcs/reel
LM78M06IDT/TR	TO252-2L	LM78M06	REEL	2500pcs/reel
LM78M08IDT/TR	TO252-2L	LM78M08	REEL	2500pcs/reel
LM78M09IDT/TR	TO252-2L	LM78M09	REEL	2500pcs/reel
LM78M10IDT/TR	TO252-2L	LM78M10	REEL	2500pcs/reel
LM78M12IDT/TR	TO252-2L	LM78M12	REEL	2500pcs/reel
LM78M15IDT/TR	TO252-2L	LM78M15	REEL	2500pcs/reel
LM78M24IDT/TR	TO252-2L	LM78M24	REEL	2500pcs/reel
LM78M05CMP/TR	SOT223	78M05	REEL	2000pcs/reel
LM78M06CMP/TR		78M06	REEL	2000pcs/reel
LM78M08CMP/TR		78M08	REEL	2000pcs/reel
LM78M09CMP/TR		78M09	REEL	2000pcs/reel
LM78M10CMP/TR		78M10	REEL	2000pcs/reel
LM78M12CMP/TR		78M12	REEL	2000pcs/reel
LM78M15CMP/TR		78M15	REEL	2000pcs/reel
LM78M24CMP/TR		78M24	REEL	2000pcs/reel
LM78M05IMP/TR	SOT223	78M05	REEL	2000pcs/reel
LM78M06IMP/TR		78M06	REEL	2000pcs/reel
LM78M08IMP/TR		78M08	REEL	2000pcs/reel
LM78M09IMP/TR		78M09	REEL	2000pcs/reel
LM78M10IMP/TR		78M10	REEL	2000pcs/reel
LM78M12IMP/TR		78M12	REEL	2000pcs/reel
LM78M15IMP/TR		78M15	REEL	2000pcs/reel
LM78M24IMP/TR		78M24	REEL	2000pcs/reel

### 3 Maximum ratings

**Table 2. Absolute maximum ratings**

Symbol	Parameter		Value	Unit
$V_I$	DC input voltage	for $V_O = 5$ to $18$ V	35	V
		for $V_O = 20, 24$ V	40	
$I_O$	Output current		Internally limited	mA
$P_D$	Power dissipation		Internally limited	mW
$T_{STG}$	Storage temperature range		-65 to 150	°C
$T_{OP}$	Operating junction temperature range	for LM78MxxC	0 to 70	°C
		for LM78MxxI	-40 to 85	

*Note:* Absolute maximum ratings are those values beyond which damage to the device may occur. Functional operation under these condition is not implied.

**Table 3. Thermal data**

Symbol	Parameter	DPAK	Unit
$R_{thJC}$	Thermal resistance junction-case	8	°C/W
$R_{thJA}$	Thermal resistance junction-ambient	100	°C/W

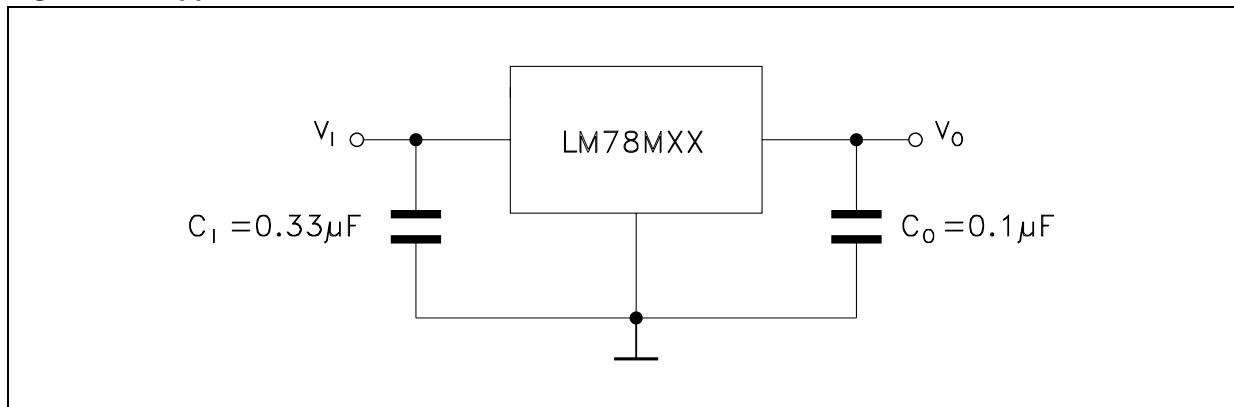
**Figure 4. Application circuit**

## 5 Electrical characteristics

**Table 4. Electrical characteristics of 78M05**

 Refer to the test circuits,  $V_I = 10\text{ V}$ ,  $I_O = 350\text{ mA}$ ,  $C_I = 0.33\text{ }\mu\text{F}$ ,  $C_O = 0.1\text{ }\mu\text{F}$ ,  $T_J = -40\text{ to }125\text{ }^\circ\text{C}$  (AB),  $T_J = 0\text{ to }125\text{ }^\circ\text{C}$  (AC) unless otherwise specified.

Symbol	Parameter	Test conditions	Min.	Typ.	Max.	Unit
$V_O$	Output voltage	$T_J = 25^\circ\text{C}$	4.9	5	5.1	V
$V_O$	Output voltage	$I_O = 5\text{ to }350\text{ mA}$ , $V_I = 7\text{ to }20\text{ V}$	4.8	5	5.2	V
$\Delta V_O$	Line regulation	$V_I = 7\text{ to }25\text{ V}$ , $I_O = 200\text{ mA}$ , $T_J = 25^\circ\text{C}$			100	mV
		$V_I = 8\text{ to }25\text{ V}$ , $I_O = 200\text{ mA}$ , $T_J = 25^\circ\text{C}$			50	
$\Delta V_O$	Load regulation	$I_O = 5\text{ to }500\text{ mA}$ , $T_J = 25^\circ\text{C}$			100	mV
		$I_O = 5\text{ to }200\text{ mA}$ , $T_J = 25^\circ\text{C}$			50	
$I_d$	Quiescent current	$T_J = 25^\circ\text{C}$			6	mA
$\Delta I_d$	Quiescent current change	$I_O = 5\text{ to }350\text{ mA}$			0.5	mA
		$I_O = 200\text{ mA}$ , $V_I = 8\text{ to }25\text{ V}$			0.8	
$\Delta V_O/\Delta T$	Output voltage drift	$I_O = 5\text{ mA}$		-0.5		mV/ $^\circ\text{C}$
SVR	Supply voltage rejection	$V_I = 8\text{ to }18\text{ V}$ , $f = 120\text{ Hz}$ , $I_O = 300\text{ mA}$ , $T_J = 25^\circ\text{C}$	62			dB
eN	Output noise voltage	$B = 10\text{ Hz to }100\text{ kHz}$ , $T_J = 25^\circ\text{C}$		40		$\mu\text{V}$
$V_d$	Dropout voltage	$T_J = 25^\circ\text{C}$		2		V
$I_{sc}$	Short circuit current	$T_J = 25^\circ\text{C}$ , $V_I = 35\text{ V}$		300		mA
$I_{scp}$	Short circuit peak current	$T_J = 25^\circ\text{C}$		700		mA

**Table 5. Electrical characteristics of 78M06**

 Refer to the test circuits,  $V_I = 11\text{ V}$ ,  $I_O = 350\text{ mA}$ ,  $C_I = 0.33\text{ }\mu\text{F}$ ,  $C_O = 0.1\text{ }\mu\text{F}$ ,  $T_J = -40\text{ to }125\text{ }^\circ\text{C}$  (AB),  $T_J = 0\text{ to }125\text{ }^\circ\text{C}$  (AC) unless otherwise specified.

Symbol	Parameter	Test conditions	Min.	Typ.	Max.	Unit
$V_O$	Output voltage	$T_J = 25^\circ\text{C}$	5.88	6	6.12	V
$V_O$	Output voltage	$I_O = 5\text{ to }350\text{ mA}$ , $V_I = 8\text{ to }21\text{ V}$	5.75	6	6.3	V
$\Delta V_O$	Line regulation	$V_I = 8\text{ to }25\text{ V}$ , $I_O = 200\text{ mA}$ , $T_J = 25^\circ\text{C}$			100	mV
		$V_I = 9\text{ to }25\text{ V}$ , $I_O = 200\text{ mA}$ , $T_J = 25^\circ\text{C}$			30	
$\Delta V_O$	Load regulation	$I_O = 5\text{ to }500\text{ mA}$ , $T_J = 25^\circ\text{C}$			120	mV
		$I_O = 5\text{ to }200\text{ mA}$ , $T_J = 25^\circ\text{C}$			60	
$I_d$	Quiescent current	$T_J = 25^\circ\text{C}$			6	mA
$\Delta I_d$	Quiescent current change	$I_O = 5\text{ to }350\text{ mA}$			0.5	mA
		$I_O = 200\text{ mA}$ , $V_I = 9\text{ to }25\text{ V}$			0.8	
$\Delta V_O/\Delta T$	Output voltage drift	$I_O = 5\text{ mA}$		-0.5		mV/ $^\circ\text{C}$
SVR	Supply voltage rejection	$V_I = 9\text{ to }19\text{ V}$ , $f = 120\text{ Hz}$ , $I_O = 300\text{ mA}$ , $T_J = 25^\circ\text{C}$	59			dB
eN	Output noise voltage	$B = 10\text{ Hz to }100\text{ kHz}$		45		$\mu\text{V}$
$V_d$	Dropout voltage	$T_J = 25^\circ\text{C}$		2		V
$I_{sc}$	Short circuit current	$T_J = 25^\circ\text{C}$ , $V_I = 35\text{ V}$		270		mA
$I_{scp}$	Short circuit peak current	$T_J = 25^\circ\text{C}$		700		mA

**Table 6. Electrical characteristics of 78M08**

 Refer to the test circuits,  $V_I = 14\text{ V}$ ,  $I_O = 350\text{ mA}$ ,  $C_I = 0.33\text{ }\mu\text{F}$ ,  $C_O = 0.1\text{ }\mu\text{F}$ ,  $T_J = -40\text{ to }125\text{ }^\circ\text{C}$  (AB),  $T_J = 0\text{ to }125\text{ }^\circ\text{C}$  (AC) unless otherwise specified).

Symbol	Parameter	Test conditions	Min.	Typ.	Max.	Unit
$V_O$	Output voltage	$T_J = 25^\circ\text{C}$	7.84	8	8.16	V
$V_O$	Output voltage	$I_O = 5\text{ to }350\text{ mA}$ , $V_I = 10.5\text{ to }23\text{ V}$	7.7	8	8.3	V
$\Delta V_O$	Line regulation	$V_I = 10.5\text{ to }25\text{ V}$ , $I_O = 200\text{ mA}$ , $T_J = 25^\circ\text{C}$			100	mV
		$V_I = 11\text{ to }25\text{ V}$ , $I_O = 200\text{ mA}$ , $T_J = 25^\circ\text{C}$			30	
$\Delta V_O$	Load regulation	$I_O = 5\text{ to }500\text{ mA}$ , $T_J = 25^\circ\text{C}$			160	mV
		$I_O = 5\text{ to }200\text{ mA}$ , $T_J = 25^\circ\text{C}$			80	
$I_d$	Quiescent current	$T_J = 25^\circ\text{C}$			6	mA
$\Delta I_d$	Quiescent current change	$I_O = 5\text{ to }350\text{ mA}$			0.5	mA
		$I_O = 200\text{ mA}$ , $V_I = 10.5\text{ to }25\text{ V}$			0.8	
$\Delta V_O/\Delta T$	Output voltage drift	$I_O = 5\text{ mA}$		-0.5		mV/ $^\circ\text{C}$
SVR	Supply voltage rejection	$V_I = 11.5\text{ to }21.5\text{ V}$ , $f = 120\text{ Hz}$ $I_O = 300\text{ mA}$ , $T_J = 25^\circ\text{C}$	56			dB
eN	Output noise voltage	$B = 10\text{ Hz to }100\text{ kHz}$ , $T_J = 25^\circ\text{C}$		52		$\mu\text{V}$
$V_d$	Dropout voltage	$T_J = 25^\circ\text{C}$		2		V
$I_{sc}$	Short circuit current	$T_J = 25^\circ\text{C}$ , $V_I = 35\text{ V}$		250		mA
$I_{scp}$	Short circuit peak current	$T_J = 25^\circ\text{C}$		700		mA

**Table 7. Electrical characteristics of 78M09**

 Refer to the test circuits,  $V_I = 15\text{ V}$ ,  $I_O = 350\text{ mA}$ ,  $C_I = 0.33\text{ }\mu\text{F}$ ,  $C_O = 0.1\text{ }\mu\text{F}$ ,  $T_J = -40\text{ to }125\text{ }^\circ\text{C}$  (AB),  $T_J = 0\text{ to }125\text{ }^\circ\text{C}$  (AC) unless otherwise specified).

Symbol	Parameter	Test conditions	Min.	Typ.	Max.	Unit
$V_O$	Output voltage	$T_J = 25^\circ\text{C}$	8.82	9	9.18	V
$V_O$	Output voltage	$I_O = 5\text{ to }350\text{ mA}$ , $V_I = 11.5\text{ to }24\text{ V}$	8.64	9	9.36	V
$\Delta V_O$	Line regulation	$V_I = 11.5\text{ to }25\text{ V}$ , $I_O = 200\text{ mA}$ , $T_J = 25^\circ\text{C}$			100	mV
		$V_I = 12\text{ to }25\text{ V}$ , $I_O = 200\text{ mA}$ , $T_J = 25^\circ\text{C}$			30	
$\Delta V_O$	Load regulation	$I_O = 5\text{ to }500\text{ mA}$ , $T_J = 25^\circ\text{C}$			180	mV
		$I_O = 5\text{ to }200\text{ mA}$ , $T_J = 25^\circ\text{C}$			90	
$I_d$	Quiescent current	$T_J = 25^\circ\text{C}$			6	mA
$\Delta I_d$	Quiescent current change	$I_O = 5\text{ to }350\text{ mA}$			0.5	mA
		$I_O = 200\text{ mA}$ , $V_I = 11.5\text{ to }25\text{ V}$			0.8	
$\Delta V_O/\Delta T$	Output voltage drift	$I_O = 5\text{ mA}$		-0.5		mV/ $^\circ\text{C}$
SVR	Supply voltage rejection	$V_I = 12.5\text{ to }23\text{ V}$ , $f = 120\text{ Hz}$ , $I_O = 300\text{ mA}$ , $T_J = 25^\circ\text{C}$	56			dB
eN	Output noise voltage	$B = 10\text{ Hz to }100\text{ kHz}$ , $T_J = 25^\circ\text{C}$		52		$\mu\text{V}$
$V_d$	Dropout voltage	$T_J = 25^\circ\text{C}$		2		V
$I_{sc}$	Short circuit current	$V_I = 35\text{ V}$ , $T_J = 25^\circ\text{C}$		250		mA
$I_{scp}$	Short circuit peak current	$T_J = 25^\circ\text{C}$		700		mA

**Table 8. Electrical characteristics of 78M10**

 Refer to the test circuits,  $V_I = 16\text{ V}$ ,  $I_O = 350\text{ mA}$ ,  $C_I = 0.33\text{ }\mu\text{F}$ ,  $C_O = 0.1\text{ }\mu\text{F}$ ,  
 $T_J = -40\text{ to }125\text{ }^\circ\text{C}$  (AB),  $T_J = 0\text{ to }125\text{ }^\circ\text{C}$  (AC) unless otherwise specified.

Symbol	Parameter	Test conditions	Min.	Typ.	Max.	Unit
$V_O$	Output voltage	$T_J = 25^\circ\text{C}$	9.8	10	10.2	V
$V_O$	Output voltage	$I_O = 5\text{ to }350\text{ mA}$ , $V_I = 12.5\text{ to }25\text{ V}$	9.6	10	10.4	V
$\Delta V_O$	Line regulation	$V_I = 12.5\text{ to }30\text{ V}$ , $I_O = 200\text{ mA}$ , $T_J = 25^\circ\text{C}$			100	mV
		$V_I = 13\text{ to }30\text{ V}$ , $I_O = 200\text{ mA}$ , $T_J = 25^\circ\text{C}$			30	
$\Delta V_O$	Load regulation	$I_O = 5\text{ to }500\text{ mA}$ , $T_J = 25^\circ\text{C}$			200	mV
		$I_O = 5\text{ to }200\text{ mA}$ , $T_J = 25^\circ\text{C}$			100	
$I_d$	Quiescent current	$T_J = 25^\circ\text{C}$			6	mA
$\Delta I_d$	Quiescent current change	$I_O = 5\text{ to }350\text{ mA}$			0.5	mA
		$I_O = 200\text{ mA}$ , $V_I = 12.5\text{ to }30\text{ V}$			0.8	
$\Delta V_O/\Delta T$	Output voltage drift	$I_O = 5\text{ mA}$		-0.5		mV/ $^\circ\text{C}$
SVR	Supply voltage rejection	$V_I = 13.5\text{ to }24\text{ V}$ , $f = 120\text{ Hz}$ , $I_O = 300\text{ mA}$ , $T_J = 25^\circ\text{C}$	56			dB
eN	Output noise voltage	$B = 10\text{ Hz to }100\text{ kHz}$ , $T_J = 25^\circ\text{C}$		64		$\mu\text{V}$
$V_d$	Dropout voltage	$T_J = 25^\circ\text{C}$		2		V
$I_{sc}$	Short circuit current	$V_I = 35\text{ V}$ , $T_J = 25^\circ\text{C}$		245		mA
$I_{scp}$	Short circuit peak current	$T_J = 25^\circ\text{C}$		700		mA

**Table 9. Electrical characteristics of 78M12**

 Refer to the test circuits,  $V_I = 19\text{ V}$ ,  $I_O = 350\text{ mA}$ ,  $C_I = 0.33\text{ }\mu\text{F}$ ,  $C_O = 0.1\text{ }\mu\text{F}$ ,  
 $T_J = -40\text{ to }125\text{ }^\circ\text{C}$  (AB),  $T_J = 0\text{ to }125\text{ }^\circ\text{C}$  (AC) unless otherwise specified.

Symbol	Parameter	Test conditions	Min.	Typ.	Max.	Unit
$V_O$	Output voltage	$T_J = 25^\circ\text{C}$	11.75	12	12.25	V
$V_O$	Output voltage	$I_O = 5\text{ to }350\text{ mA}$ , $V_I = 14.5\text{ to }27\text{ V}$	11.5	12	12.5	V
$\Delta V_O$	Line regulation	$V_I = 14.5\text{ to }30\text{ V}$ , $I_O = 200\text{ mA}$ , $T_J = 25^\circ\text{C}$			100	mV
		$V_I = 16\text{ to }30\text{ V}$ , $I_O = 200\text{ mA}$ , $T_J = 25^\circ\text{C}$			30	
$\Delta V_O$	Load regulation	$I_O = 5\text{ to }500\text{ mA}$ , $T_J = 25^\circ\text{C}$			240	mV
		$I_O = 5\text{ to }200\text{ mA}$ , $T_J = 25^\circ\text{C}$			120	
$I_d$	Quiescent current	$T_J = 25^\circ\text{C}$			6	mA
$\Delta I_d$	Quiescent current change	$I_O = 5\text{ to }350\text{ mA}$			0.5	mA
		$I_O = 200\text{ mA}$ , $V_I = 14.5\text{ to }30\text{ V}$			0.8	
$\Delta V_O/\Delta T$	Output voltage drift	$I_O = 5\text{ mA}$		-1		mV/ $^\circ\text{C}$
SVR	Supply voltage rejection	$V_I = 15\text{ to }25\text{ V}$ , $f = 120\text{ Hz}$ , $I_O = 300\text{ mA}$ , $T_J = 25^\circ\text{C}$	55			dB
eN	Output noise voltage	$B = 10\text{ Hz to }100\text{ kHz}$ , $T_J = 25^\circ\text{C}$		75		$\mu\text{V}$
$V_d$	Dropout voltage	$T_J = 25^\circ\text{C}$		2		V
$I_{sc}$	Short circuit current	$V_I = 35\text{ V}$ , $T_J = 25^\circ\text{C}$		240		mA
$I_{scp}$	Short circuit peak current	$T_J = 25^\circ\text{C}$		700		mA

**Table 10. Electrical characteristics of 78M15**

 Refer to the test circuits,  $V_I = 23\text{ V}$ ,  $I_O = 350\text{ mA}$ ,  $C_I = 0.33\text{ }\mu\text{F}$ ,  $C_O = 0.1\text{ }\mu\text{F}$ ,  $T_J = -40\text{ to }125\text{ }^\circ\text{C}$  (AB),  $T_J = 0\text{ to }125\text{ }^\circ\text{C}$  (AC) unless otherwise specified.

Symbol	Parameter	Test conditions	Min.	Typ.	Max.	Unit
$V_O$	Output voltage	$T_J = 25^\circ\text{C}$	14.7	15	15.3	V
$V_O$	Output voltage	$I_O = 5\text{ to }350\text{ mA}$ , $V_I = 17.5\text{ to }30\text{ V}$	14.4	15	15.6	V
$\Delta V_O$	Line regulation	$V_I = 17.5\text{ to }30\text{ V}$ , $I_O = 200\text{ mA}$ , $T_J = 25^\circ\text{C}$			100	mV
		$V_I = 20\text{ to }30\text{ V}$ , $I_O = 200\text{ mA}$ , $T_J = 25^\circ\text{C}$			30	
$\Delta V_O$	Load regulation	$I_O = 5\text{ to }500\text{ mA}$ , $T_J = 25^\circ\text{C}$			300	mV
		$I_O = 5\text{ to }200\text{ mA}$ , $T_J = 25^\circ\text{C}$			150	
$I_d$	Quiescent current	$T_J = 25^\circ\text{C}$			6	mA
$\Delta I_d$	Quiescent current change	$I_O = 5\text{ to }350\text{ mA}$			0.5	mA
		$I_O = 200\text{ mA}$ , $V_I = 17.5\text{ to }30\text{ V}$			0.8	
$\Delta V_O/\Delta T$	Output voltage drift	$I_O = 5\text{ mA}$		-1		mV/ $^\circ\text{C}$
SVR	Supply voltage rejection	$V_I = 18.5\text{ to }28.5\text{ V}$ , $f = 120\text{ Hz}$ , $I_O = 300\text{ mA}$ , $T_J = 25^\circ\text{C}$	54			dB
eN	Output noise voltage	$B = 10\text{ Hz to }100\text{ kHz}$ , $T_J = 25^\circ\text{C}$		90		$\mu\text{V}$
$V_d$	Dropout voltage	$T_J = 25^\circ\text{C}$		2		V
$I_{sc}$	Short circuit current	$V_I = 35\text{ V}$ , $T_J = 25^\circ\text{C}$		240		mA
$I_{scp}$	Short circuit peak current	$T_J = 25^\circ\text{C}$		700		mA

**Table 11. Electrical characteristics of 78M24**

 Refer to the test circuits,  $V_I = 33\text{ V}$ ,  $I_O = 350\text{ mA}$ ,  $C_I = 0.33\text{ }\mu\text{F}$ ,  $C_O = 0.1\text{ }\mu\text{F}$ ,  $T_J = -40\text{ to }125\text{ }^\circ\text{C}$  (AB),  $T_J = 0\text{ to }125\text{ }^\circ\text{C}$  (AC) unless otherwise specified.

Symbol	Parameter	Test conditions	Min.	Typ.	Max.	Unit
$V_O$	Output voltage	$T_J = 25^\circ\text{C}$	23.5	24	24.5	V
$V_O$	Output voltage	$I_O = 5\text{ to }350\text{ mA}$ , $V_I = 27\text{ to }38\text{ V}$	23	24	25	V
$\Delta V_O$	Line regulation	$V_I = 27\text{ to }38\text{ V}$ , $I_O = 200\text{ mA}$ , $T_J = 25^\circ\text{C}$			100	mV
		$V_I = 28\text{ to }38\text{ V}$ , $I_O = 200\text{ mA}$ , $T_J = 25^\circ\text{C}$			30	
$\Delta V_O$	Load regulation	$I_O = 5\text{ to }500\text{ mA}$ , $T_J = 25^\circ\text{C}$			480	mV
		$I_O = 5\text{ to }200\text{ mA}$ , $T_J = 25^\circ\text{C}$			240	
$I_d$	Quiescent current	$T_J = 25^\circ\text{C}$			6	mA
$\Delta I_d$	Quiescent current change	$I_O = 5\text{ to }350\text{ mA}$			0.5	mA
		$I_O = 200\text{ mA}$ , $V_I = 27\text{ to }38\text{ V}$			0.8	
$\Delta V_O/\Delta T$	Output voltage drift	$I_O = 5\text{ mA}$		-1.2		mV/ $^\circ\text{C}$
SVR	Supply voltage rejection	$V_I = 28\text{ to }38\text{ V}$ , $f = 120\text{ Hz}$ , $I_O = 300\text{ mA}$ , $T_J = 25^\circ\text{C}$	50			dB
eN	Output noise voltage	$B = 10\text{ Hz to }100\text{ kHz}$ , $T_J = 25^\circ\text{C}$		170		$\mu\text{V}$
$V_d$	Dropout voltage	$T_J = 25^\circ\text{C}$		2		V
$I_{sc}$	Short circuit current	$V_I = 35\text{ V}$ , $T_J = 25^\circ\text{C}$		240		mA
$I_{scp}$	Short circuit peak current	$T_J = 25^\circ\text{C}$		700		mA

## 6 Typical performance

Figure 8. Dropout voltage vs. junction temp. Figure 9. Dropout characteristics

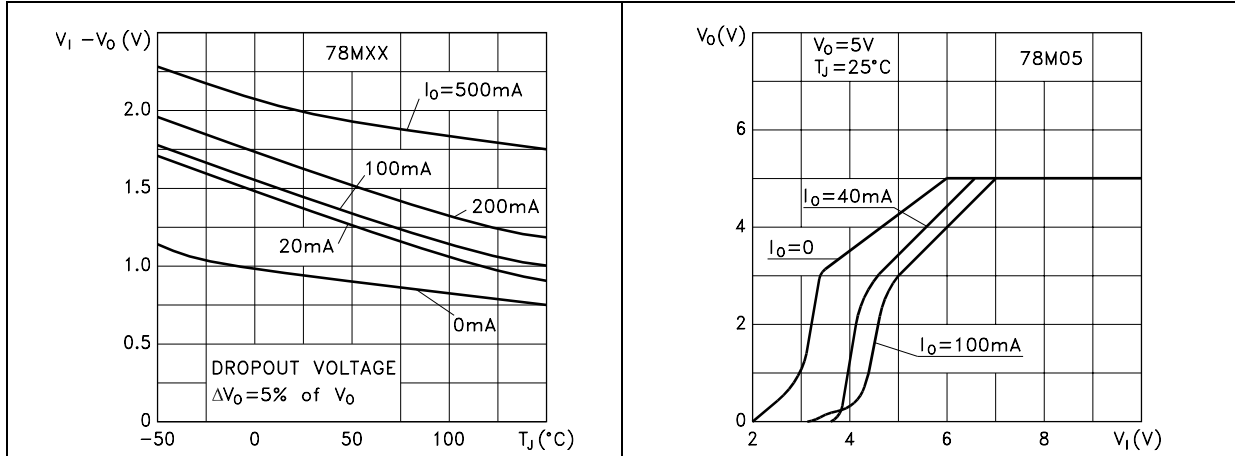

Figure 10. Peak output current vs. input-output differential voltage

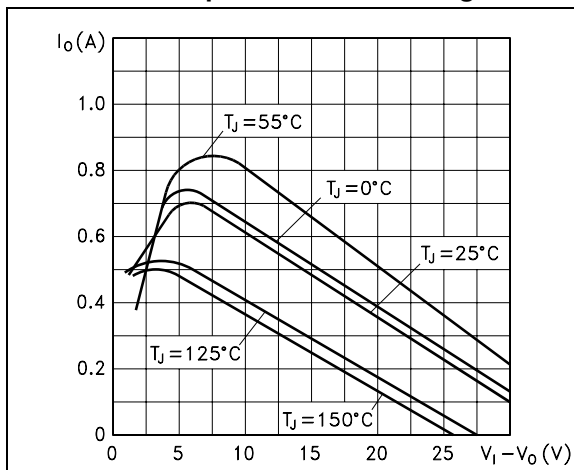

Figure 11. Output voltage vs. junction temperature

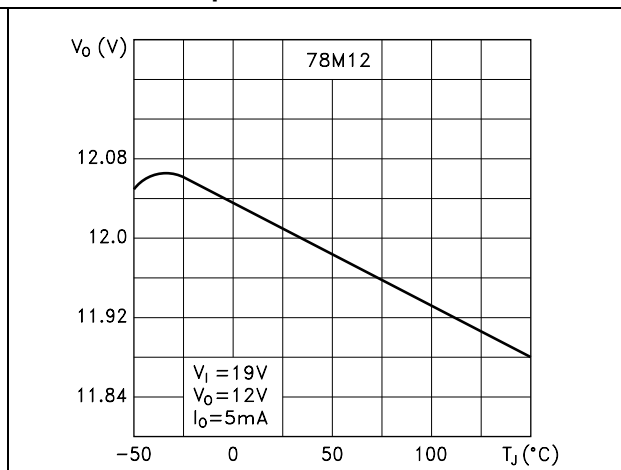

Figure 12. Supply voltage rejection vs. frequency

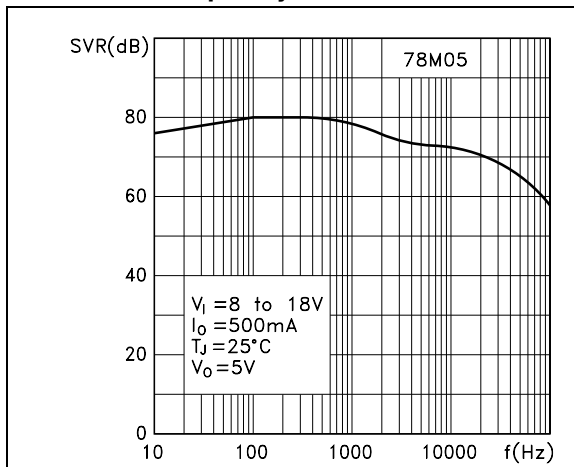
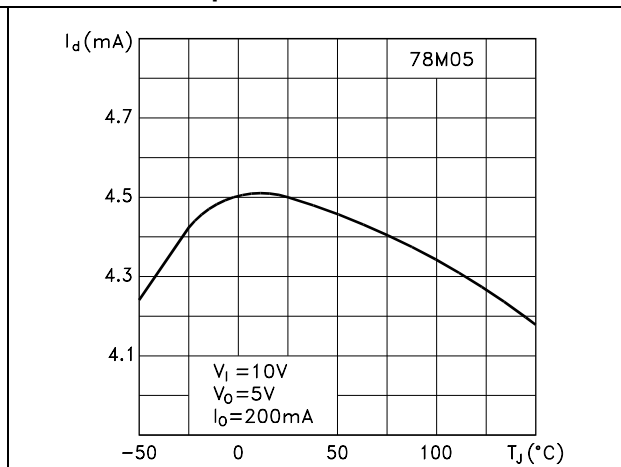
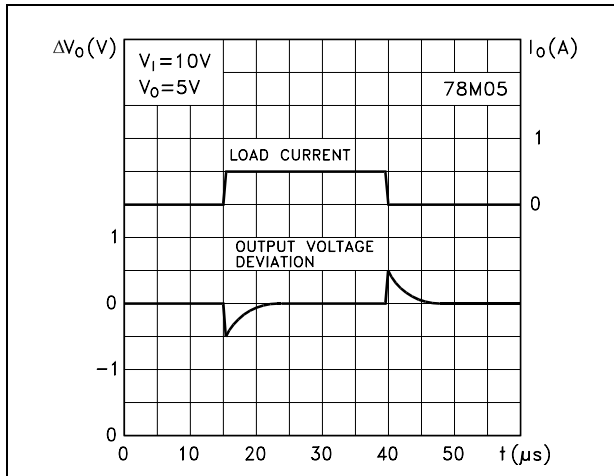

Figure 13. Quiescent current vs. junction temperature

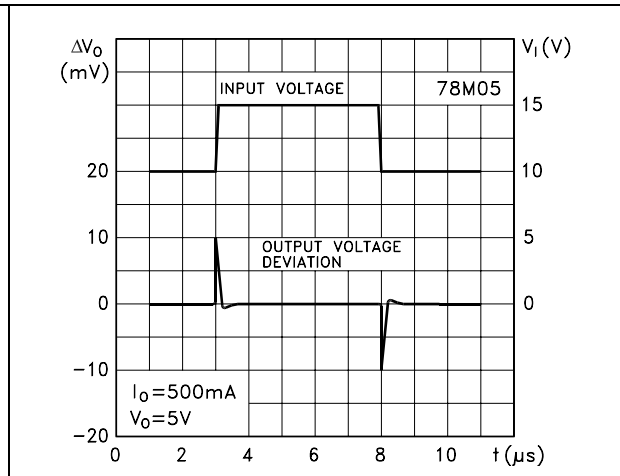



**Figure 14. Load transient response**



**Figure 15. Line transient response**



**Figure 16. Quiescent current vs. input voltage**

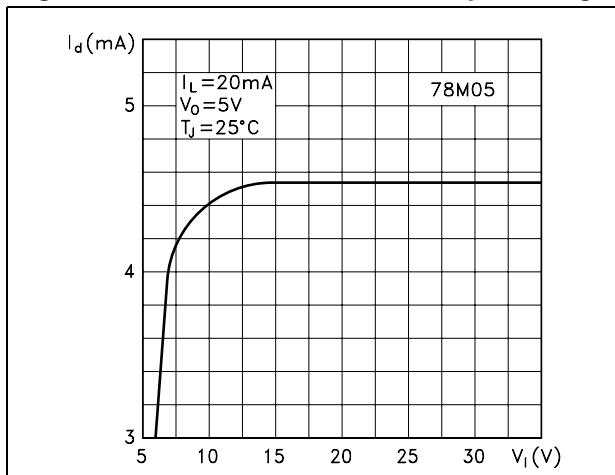

**PACKAGE**

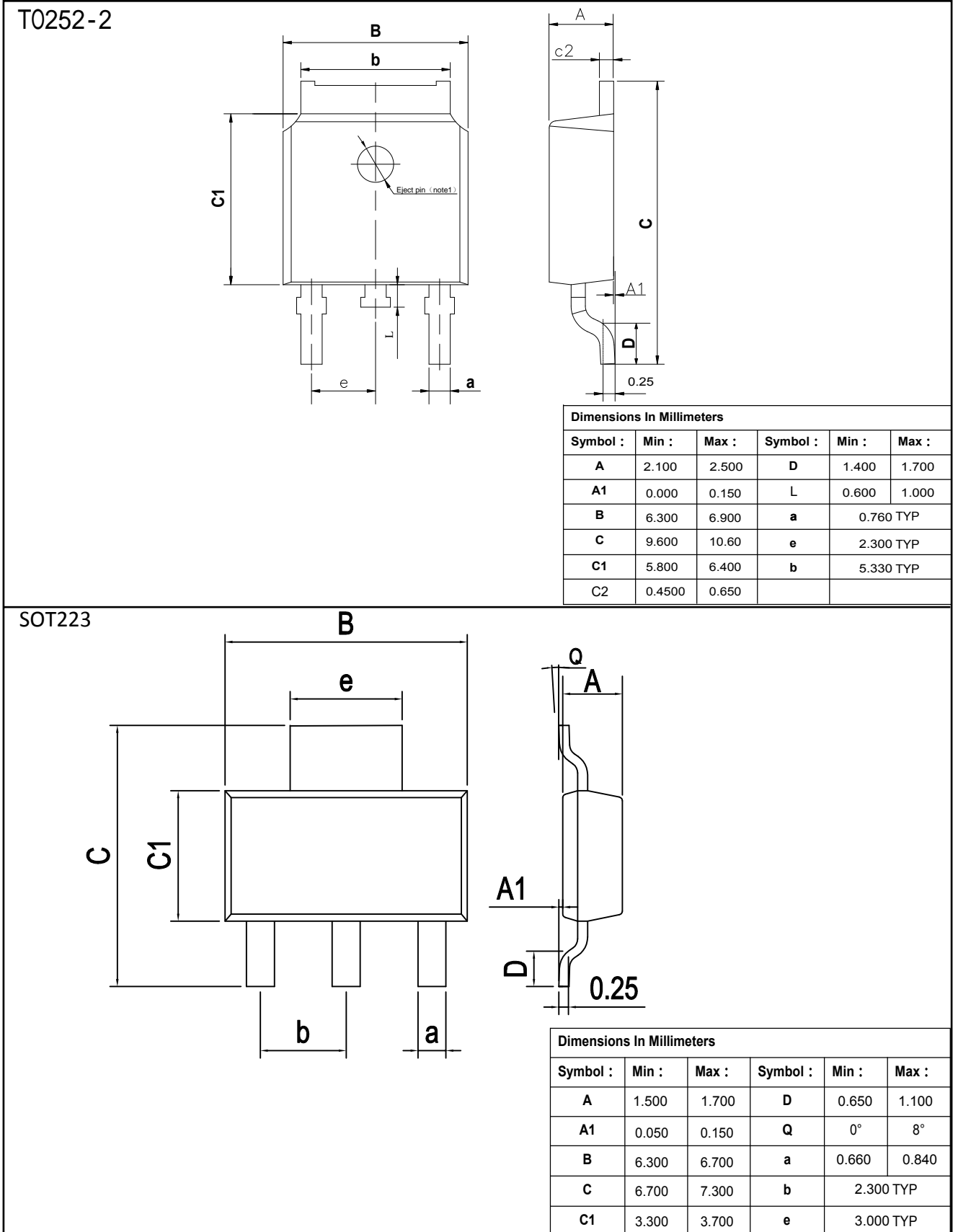

Important statement:

Huaguan Semiconductor Co,Ltd. reserves the right to change the products and services provided without notice. Customers should obtain the latest relevant information before ordering, and verify the timeliness and accuracy of this information.

Customers are responsible for complying with safety standards and taking safety measures when using our products for system design and machine manufacturing to avoid potential risks that may result in personal injury or property damage.

Our products are not licensed for applications in life support, military, aerospace, etc., so we do not bear the consequences of the application of these products in these fields.

Our documentation is only permitted to be copied without any tampering with the content, so we do not accept any responsibility or liability for the altered documents.