



CERAMIC

High Pass Filter

HFCG-4000+

Mini-Circuits

50Ω 4500 to 18000 MHz

THE BIG DEAL

- Low loss, 0.8 dB typ.
- Return loss, 12 dB typ.
- Stop Band Rejection, 42 dB typ.
- Small size 2.0 mm x 1.25 mm



Generic photo used for illustration purposes only

CASE STYLE: GE0805C-9

+RoHS Compliant

The +Suffix identifies RoHS Compliance. See our web site for RoHS Compliance methodologies and qualifications

APPLICATIONS

- Test and measurements
- Military applications
- Telecommunications and broadband wireless systems
- 5G Sub 6 GHz
- WiFi 6E and X-band Radar

PRODUCT OVERVIEW

HFCG-4000+ is a high pass filter with passband from 4500 MHz to 18000 MHz supporting a variety of applications. This model provides 0.8 dB typical insertion loss over a wide band due to strategically constructed layout. Housed in a tiny 0805 ceramic form factor with wraparound terminations, the filter is ideal for dense PCB layouts with minimal performance variation due to parasitics.

KEY FEATURES

Feature	Advantages
Small size, 2.0 mm x 1.25 mm	Accommodates tight space requirements for dense PCB layouts.
Wrap around termination	Provides excellent solderability and easy visual inspection capability.
LTCC construction	Provides a rugged package that is well suited for tough environments including high humidity and high temperature extremes.
Ultra-wide pass band	This filter has a very wide passband from 4.5 GHz to 18 GHz.

REV. OR
ECO-015247
HFCG-4000+
EDU4330
URJ
221003





CERAMIC

High Pass Filter

HFCG-4000+

ELECTRICAL SPECIFICATIONS^{1,2} AT 25°C

Parameter		F#	Frequency (MHz)	Min.	Typ.	Max.	Units
Stopband	Rejection Loss	DC-F1	DC - 2500	36	42	—	dB
		F1-F2	2500 - 3200	25	40	—	dB
	Freq. Cut-Off	F3*	4100	—	3	—	dB
Passband	Insertion Loss	F4-F5	4500 - 5200	—	2.0	—	dB
		F5-F6	5200 - 5600	—	0.8	1.9	dB
		F6-F7	5600 - 16000	—	0.8	1.5	dB
		F7-F8	16000 - 18000	—	1.2	—	dB
	Return Loss	F4-F8	4500 - 18000	—	12	—	dB

1 This component should not be employed as a DC-block. DC de-coupling capacitors are required in Applications where DC voltage and/or current is present at either input or output ports. Please contact Mini-Circuits for further support.

2 Measured on Mini-Circuits Characterization Test Board TB-HFCG-4000+

* Typically, a ±5% frequency deviation from the stated value may occur on a unit-to-unit basis.

MAXIMUM RATINGS

Parameter	Ratings
Operating temperature	-55°C to 125°C
Storage temperature	-55°C to 125°C
RF Power Input*	3W @25°C

*Passband rating, derate linearly to 0.6W at 125°C ambient
Permanent damage may occur if any of these limits are exceeded.

TYPICAL FREQUENCY RESPONSE

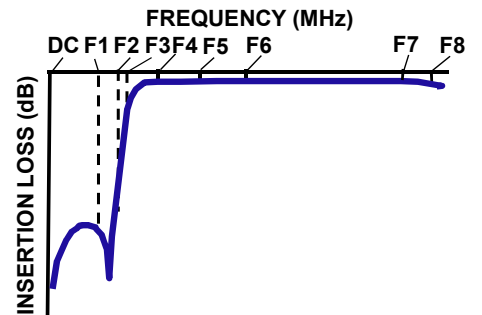

FUNCTIONAL SCHEMATIC

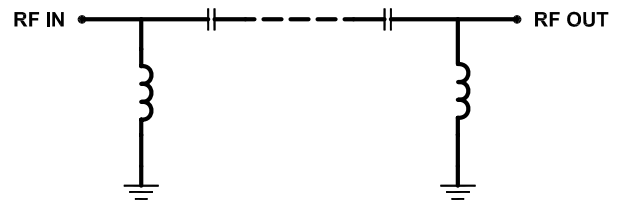



PAD CONNECTIONS

INPUT	1
OUTPUT	3
GROUND	2,4,5,6

PRODUCT MARKING: VE

DEMO BOARD MCL P/N: TB-HFCG-4000+
SUGGESTED PCB LAYOUT (PL-633)

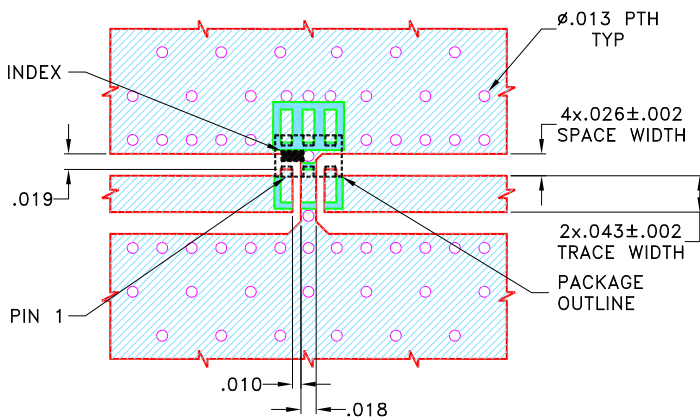

NOTES:

1. COPLANAR WAVEGUIDE PARAMETERS ARE SHOWN FOR ROGERS (R04350B) WITH DIELECTRIC THICKNESS $.020 \pm .0015$. COPPER: 1/2 Oz. EACH SIDE. FOR OTHER MATERIALS TRACE WIDTH AND GAP MAY NEED TO BE MODIFIED.
 2. BOTTOM SIDE OF THE PCB IS CONTINUOUS GROUND PLANE.
- DENOTES PCB COPPER PATTERN WITH SMOBC (SOLDER MASK OVER BARE COPPER)
 DENOTES PCB COPPER PATTERN FREE OF SOLDERMASK

OUTLINE DRAWING

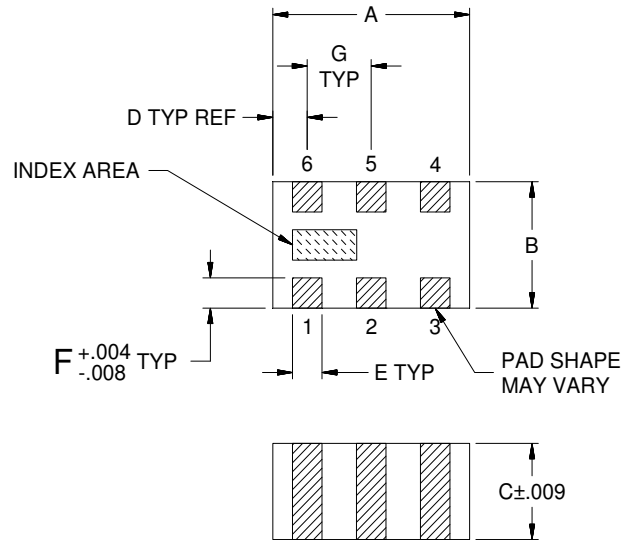

OUTLINE DIMENSIONS (Inches/mm)

A	B	C	D	E	F	G	Wt.
.079	.049	.037	.014	.012	.012	.026	grams
2.00	1.25	0.95	0.35	0.30	0.30	0.65	.008

Note: Please refer to case style drawing for details



CERAMIC

High Pass Filter

HFCG-4000+

TYPICAL PERFORMANCE DATA AT 25°C

Frequency (MHz)	Insertion Loss (dB)	Return Loss (dB)
10	83.07	0.11
500	49.66	0.21
1000	44.65	0.23
2500	45.76	0.36
3200	41.29	0.54
3420	30.48	0.65
3660	20.32	0.95
4000	6.76	3.89
4100	3.97	7.50
4500	1.35	15.03
5200	0.77	21.87
5600	0.76	14.93
10000	0.30	18.64
16000	0.39	18.72
18000	0.82	15.40

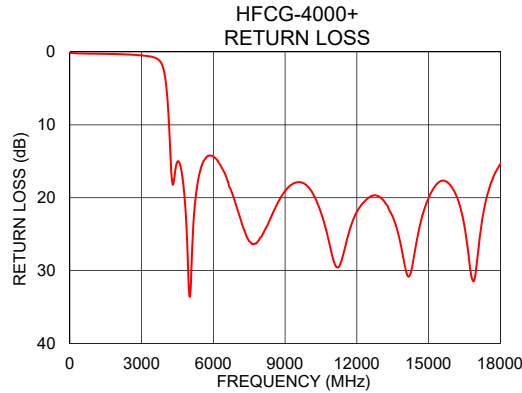
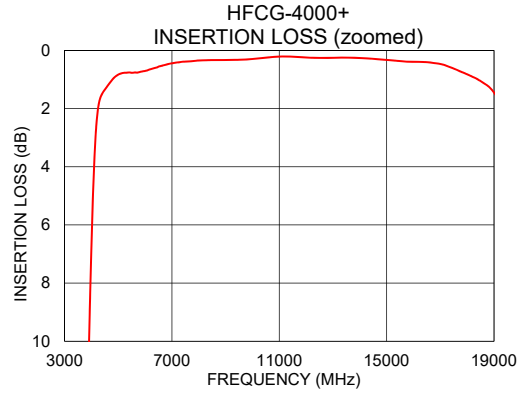
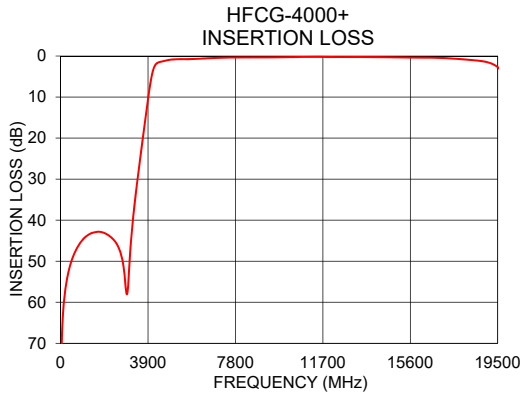

NOTES

- A. Performance and quality attributes and conditions not expressly stated in this specification document are intended to be excluded and do not form a part of this specification document.
- B. Electrical specifications and performance data contained in this specification document are based on Mini-Circuit's applicable established test performance criteria and measurement instructions.
- C. The parts covered by this specification document are subject to Mini-Circuits standard limited warranty and terms and conditions (collectively, "Standard Terms"); Purchasers of this part are entitled to the rights and benefits contained therein. For a full statement of the standard. Terms and the exclusive rights and remedies thereunder, please visit Mini-Circuits' website at www.minicircuits.com/MCLStore/terms.jsp

