



LC65R600D

N-channel Super Junction MOSFET

MAIN CHARACTERISTICS

I_D	7A
V_{DSS}	650V
RDS(ON)-typ VGS=10V	520m Ω

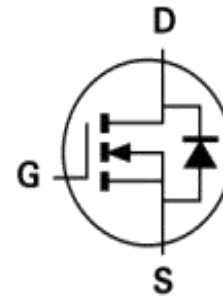

FEATURES

- Adopt advanced trench technology to provide excellent RDS(ON), low gate charge and operation with gate voltages as low as 4.5V. This device is suitable for use as a Battery protection or in other Switching application.

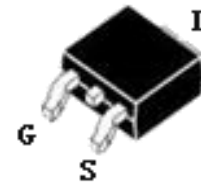

TO-252

APPLICATIONS

- Solar inverters
- LCD/LED/PDP TV
- Telecom/Server Power supplies
- AC-DC Power Supply

MECHANICAL DATA

- Case: Molded plastic
- Mounting Position: Any
- Molded Plastic: UL Flammability Classification Rating 94V-0
- Lead free in compliance with EU RoHS 2011/65/EU directive
- Solder bath temperature 275°C maximum,10s per JESD 22-B106

Product specification classification

Part Number	Package	Mode Name	Pack
LC65R600D	TO-252	LC65R600D	Tube



LC65R600D

N-channel Super Junction MOSFET

Maximum Ratings at Tc=25°C unless otherwise specified

Characteristics	Symbol	Value	Unit
		252	
Drain-Source Voltage	V_{DS}	650	V
Gate-Source Voltage	V_{GS}	±30	V
Continue Drain Current	I_D	7	A
Pulsed Drain Current (Note1)	I_{DM}	24	A
Power Dissipation	P_D	64	W
Single Pulse Avalanche Energy (Note1)	E_{AS}	129	mJ
Operating Temperature Range	T_J	-50 to +150	°C
Storage Temperature Range	T_{STG}	-50 to +150	°C
Thermal Resistance, Junction to Case	$R_{\theta JC}$	1.97	°C/W
Thermal Resistance, Junction to Ambient	$R_{\theta JA}$	62	°C/W

Note1:Pulse test: 300 μs pulse width, 2 % duty cycle

Electrical Characteristics at Tc=25°C unless otherwise specified

Characteristics	Test Condition	Symbol	Min	Typ	Max	Unit
Drain-Source Breakdown Voltage	$V_{GS} = 0 V, I_D = 250 \mu A$	BV_{DSS}	650	-	-	V
Drain-Source Leakage Current	$V_{DS} = 650 V, V_{GS} = 0 V$	I_{DSS}	-	-	1	μA
Gate Leakage Current	$V_{GS} = \pm 30 V, V_{DS} = 0 V$	I_{GSS}	-	-	±100	nA
Gate-Source Threshold Voltage	$V_{DS} = V_{GS}, I_D = 250 \mu A$	$V_{GS(th)}$	2	-	4	V
Drain-Source On-State Resistance	$V_{GS} = 10V, I_D = 3.5A$	$R_{DS(on)}$	-	520	600	mΩ
Forward Transconductance	$V_{DS} = 5 V, I_D = 2 A$	g_{fs}	-	-	8	S
Input Capacitance	$V_{DS} = 50V, V_{GS} = 0V, f = 1MHz$	C_{iss}	-	471	-	pF
Output Capacitance		C_{oss}	-	35	-	pF
Reverse Transfer Capacitance		C_{rss}	-	1.7	-	pF
Turn-on Delay Time(Note2)	$V_{DD} = 325V, I_D = 7A, V_{GS} = 10V, R_G = 25\Omega$	$t_{d(ON)}$	-	17	-	ns
Rise Time(Note2)		t_r	-	26	-	ns
Turn-Off Delay Time(Note2)		$t_{d(OFF)}$	-	53	-	ns
Fall Time(Note2)		t_f	-	38	-	ns
Total Gate Charge(Note2)	$V_{DS} = 520V, V_{GS} = 10V, I_D = 7A$	Q_G	-	13	-	nC
Gate to Source Charge(Note2)		Q_{GS}	-	2.1	-	nC
Gate to Drain Charge(Note2)		Q_{GD}	-	6.9	-	nC

Source-Drain Diode Characteristics at Ta=25°C unless otherwise specified

Characteristics	Test Condition	Symbol	Min.	Typ.	Max.	Unit
Maximun Body-Diode Continuous Current		I_S	-	-	7	A
Maximun Body-Diode Pulsed Current(Note2)		I_{SM}	-	-	24	A
Drain-Source Diode Forward Voltage	$V_{GS} = 0V, I_S = 3.5A, T_J = 25^\circ C$	V_{SD}	-	-	1.4	V

Note2:Pulse test: 300 μs pulse width, 2 % duty cycle



LC65R600D

N-channel Super Junction MOSFET

RATINGS AND CHARACTERISTIC CURVES

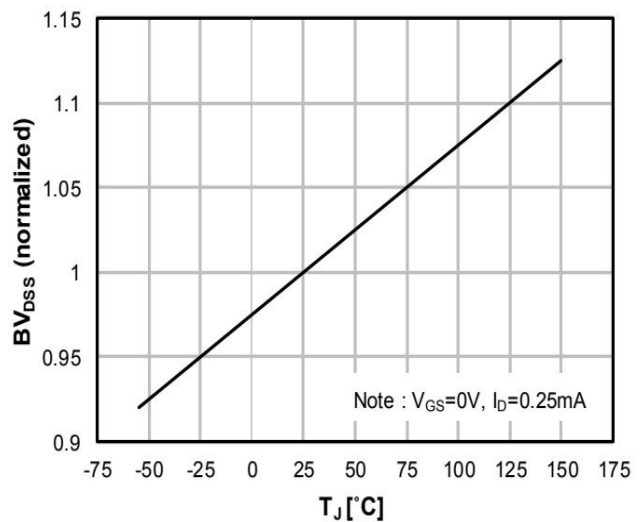
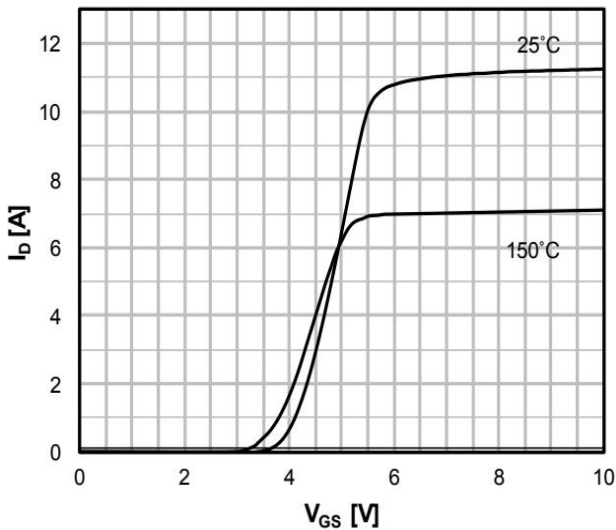
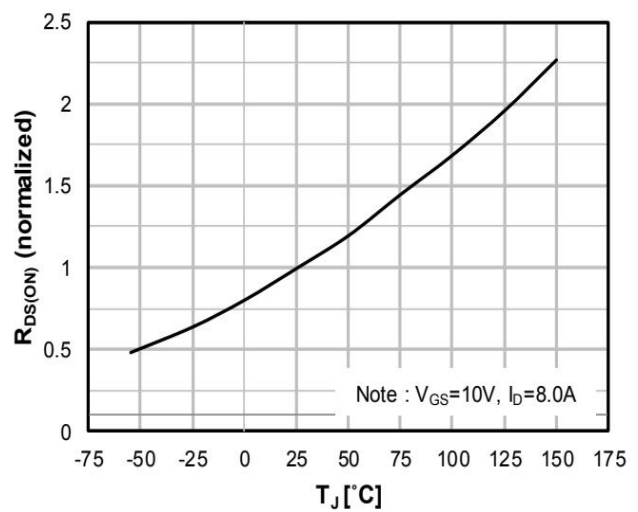
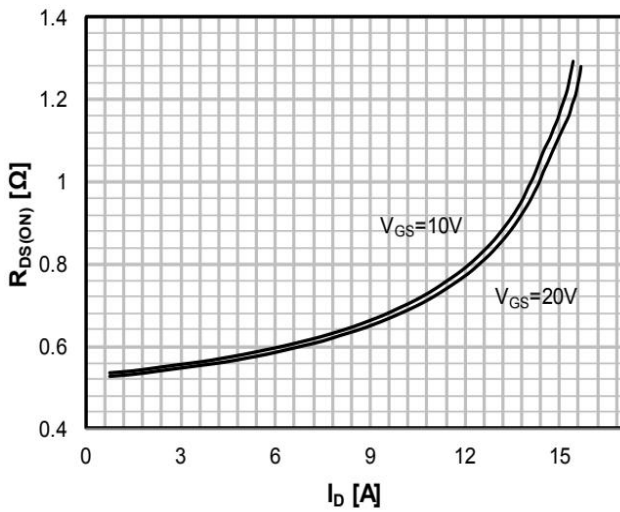
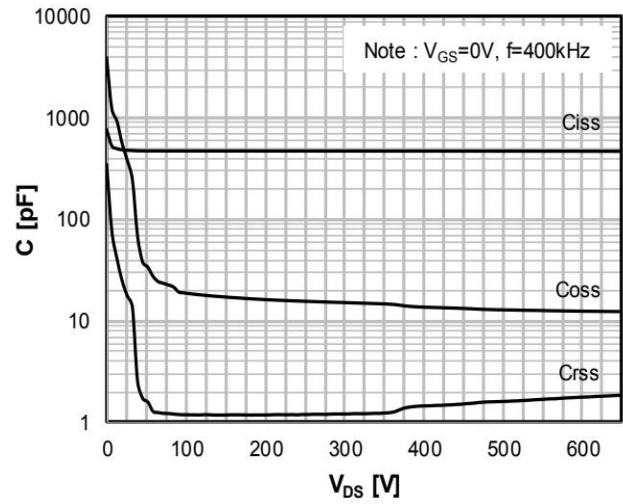
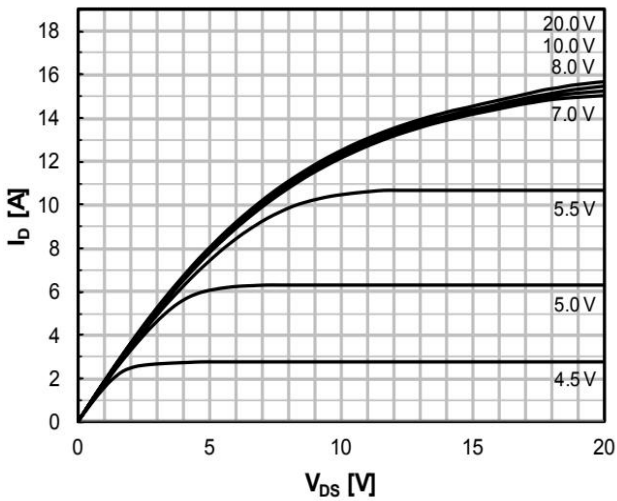



LC65R600D

N-channel Super Junction MOSFET

RATINGS AND CHARACTERISTIC CURVES

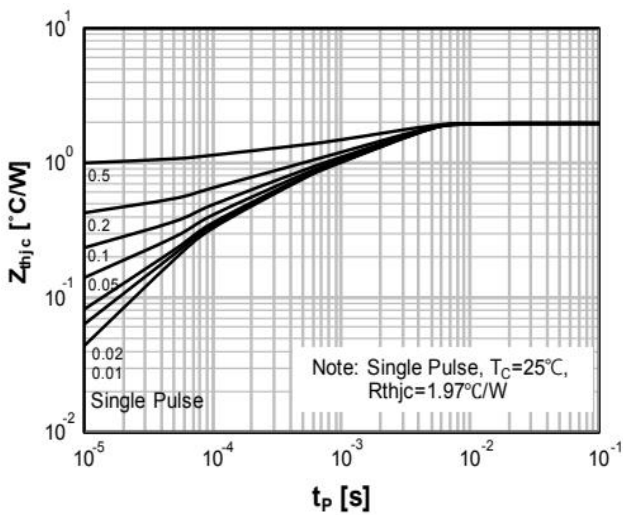
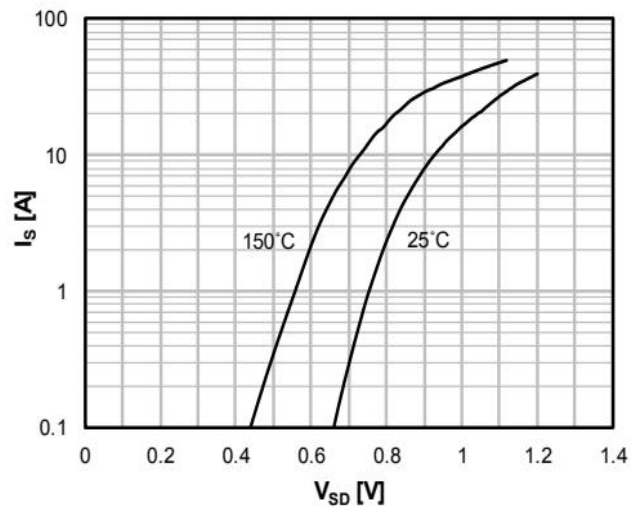
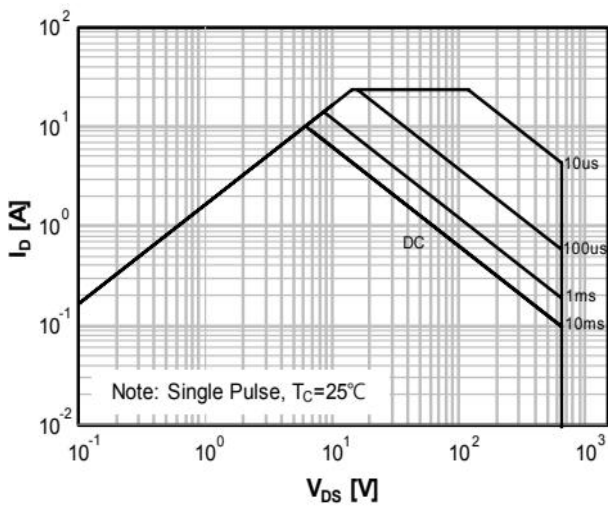
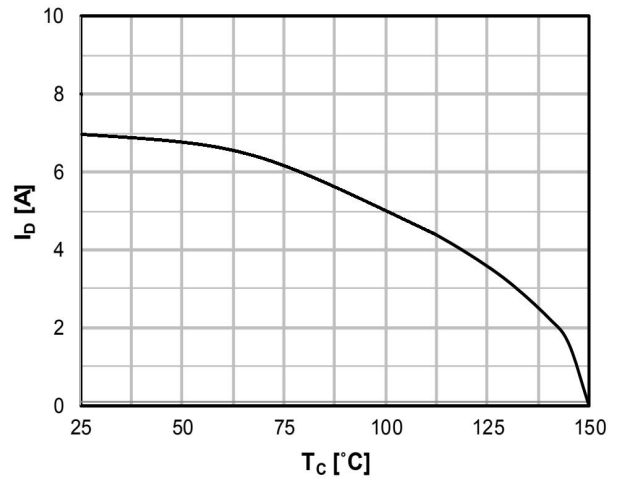
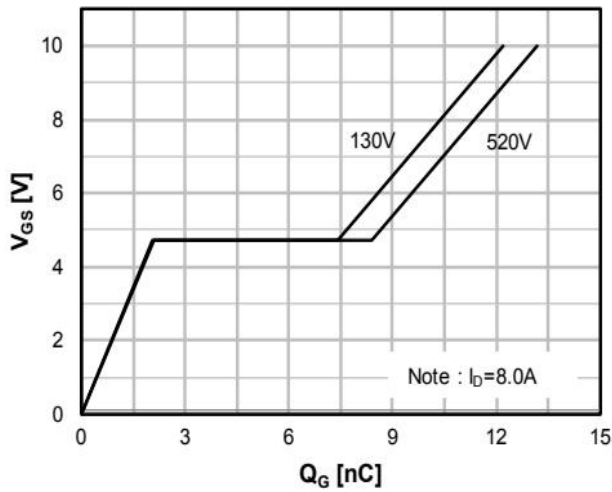



LC65R600D

N-channel Super Junction MOSFET

Package Outline Dimensions millimeters

T0-252

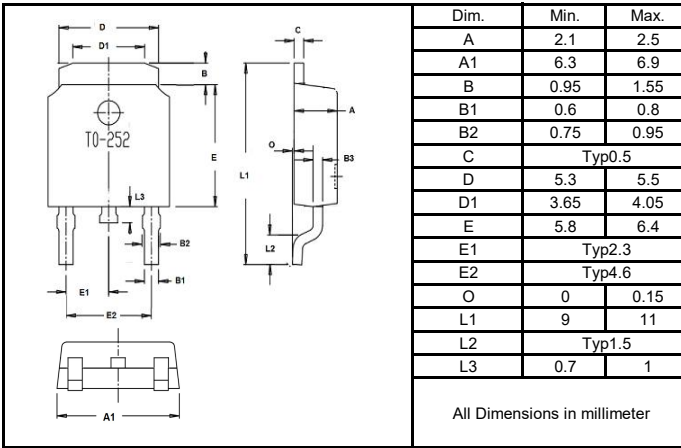

Marking on the body

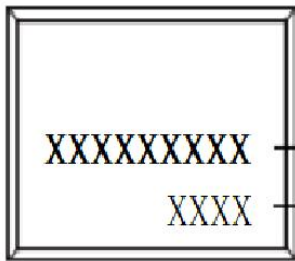

MAKING:

X X XX

Assembly code (e.g : AB,CD,.....)

month - code (WW: 1-1, 10-A...)

Year - code

(Y: Last digit of year & A:2012,B:2013...)

packing instruction

PKG	最小包装	内盒	外箱
TO-252			
	2500pcs/盘	5000pcs/盒	25000pcs/箱

Notice

All product, product specifications and data are subject to change without notice to improve. The right to explain is owned by LINGXUN electronics

company.

Confirm that operation temperature is within the specified range described in the product specification. Avoid applying power exceeding normal rated

power; exceeding the power rating under steady-state loading condition may negatively affect product performance and reliability.

LINGXUN electronics shall not be in any way responsible or liable for failure induced under deviant condition from what is defined in this document.