

600 V, 25 A ultrafast high voltage diode

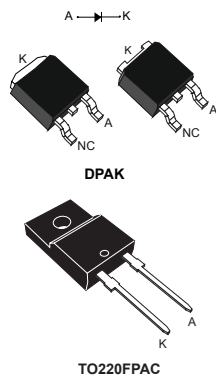

Features

- Ultrafast recovery, soft recovery
- Low power losses at high switching frequency operations
- Low leakage current
- High junction temperature
- High overcurrent capability
- ECOPACK2 compliant

Applications

- PFC
- Boost diode
- LLC clamping diode

Description

The **STTH25M06** is an ultrafast recovery power rectifier especially suited for boost or LLC clamping circuits working at high switching frequencies in heavy duty applications such as air conditioning equipment or telecom power supplies.

Designed with the latest ST's ultrafast technology, this 600 V 25 A diode in DPAK and TO-220FPAC has a robust behavior against electrostatic discharge and high overcurrent capability.

Product status	
STTH25M06	
Product summary	
Symbol	Value
$I_{F(AV)}$	25 A
V_{RRM}	600 V
$t_{rr(typ.)}$	25 ns
$T_{j(max.)}$	175 °C
$V_{F(typ.)}$	1.6 V

1 Characteristics

Table 1. Absolute ratings (limiting values at 25 °C, unless otherwise specified)

Symbol	Parameter	Value	Unit
V_{RRM}	Repetitive peak reverse voltage	600	V
$I_{F(AV)}$	Average forward current	25	A
I_{FSM}	Surge non repetitive forward current	$t_p = 10$ ms sinusoidal	A
T_{stg}	Storage temperature range	-65 to +175	°C
T_j	Maximum operating junction temperature	+175	°C

Table 2. Thermal resistance parameter

Symbol	Parameter	Typ. value	Unit
$R_{th(j-c)}$	Junction to case	DPAK	0.5
		TO-220FPAC	2.45

For more information, please refer to the following application note :

- AN5088 : Rectifiers thermal management, handling and mounting recommendations

Table 3. Static electrical characteristics

Symbol	Parameter	Test conditions	Min.	Typ.	Max.	Unit	
$I_R^{(1)}$	Reverse leakage current	$T_j = 25$ °C	-	-	60	μ A	
		$T_j = 125$ °C			70		800
$V_F^{(2)}$	Forward voltage drop	$T_j = 25$ °C	-	2.1	-	V	
		$T_j = 150$ °C		1.3			
		$T_j = 25$ °C	-	2.5			3.4
		$T_j = 150$ °C	-	1.6			2.0

1. Pulse test: $t_p = 5$ ms, $\delta < 2\%$

2. Pulse test: $t_p = 380$ μ s, $\delta < 2\%$

To evaluate the conduction losses, use the following equation:

$$P = 1.04 \times I_{F(AV)} + 0.0385 \times I_{F(RMS)}^2$$

For more information, please refer to the following application notes related to the power losses :

- AN604: Calculation of conduction losses in a power rectifier
- AN4058: Calculation of turn-off power losses generated by an ultrafast diode

Table 4. Dynamic electrical characteristics

Symbol	Parameters	Test conditions	Min.	Typ.	Max.	Unit	
t_{rr}	Reverse recovery time	$T_j = 25\text{ °C}$	$I_F = 1\text{ A}$ $di_F/dt = -50\text{ A}/\mu\text{s}$ $V_R = 30\text{ V}$	-		50	ns
			$I_F = 1\text{ A}$ $di_F/dt = -100\text{ A}/\mu\text{s}$ $V_R = 30\text{ V}$	-	25	35	
		$T_j = 125\text{ °C}$	$I_F = 15\text{ A}$ $di_F/dt = -200\text{ A}/\mu\text{s}$ $V_R = 400\text{ V}$	-	55		
			$I_F = 25\text{ A}$ $di_F/dt = -200\text{ A}/\mu\text{s}$ $V_R = 400\text{ V}$	-	60		
I_{RM}	Reverse recovery current	$T_j = 125\text{ °C}$	$I_F = 25\text{ A}$	-	7	A	
Q_{rr}	Reverse recovery charge		$di_F/dt = -200\text{ A}/\mu\text{s}$ $V_R = 400\text{ V}$	-	250	nC	

1.1 Characteristics (curves)

Figure 1. Average forward power dissipation versus average forward current (square waveform)

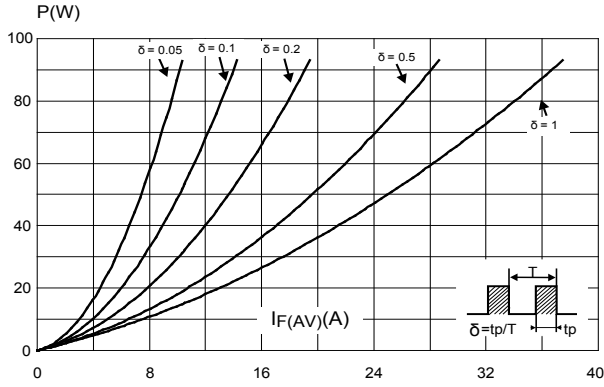

Figure 2. Forward voltage drop versus forward current (typical values)

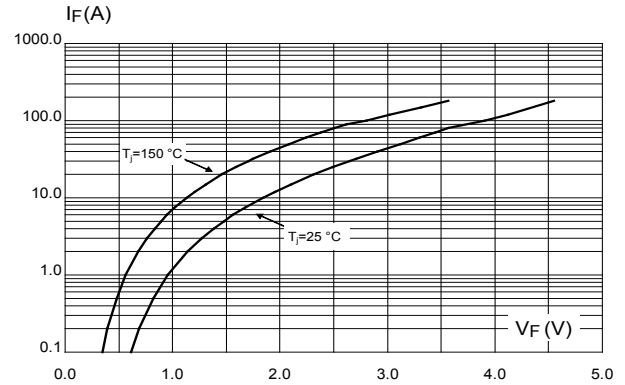

Figure 3. Forward voltage drop versus forward current (maximum values)

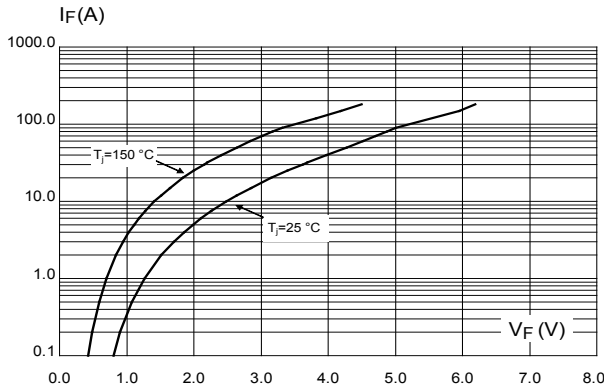

Figure 4. Relative variation of thermal impedance, junction to case versus pulse duration (DPAK)

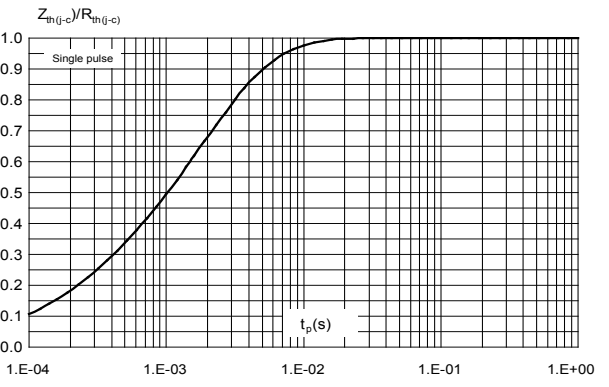

Figure 5. Relative variation of thermal impedance, junction to case versus pulse duration (TO-220FPAC)

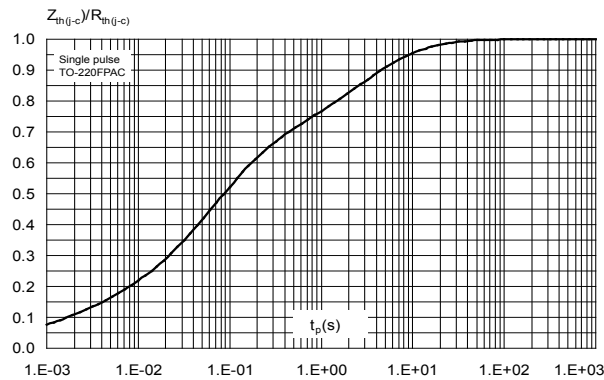

Figure 6. Peak reverse recovery current versus di_F/dt (typical values)

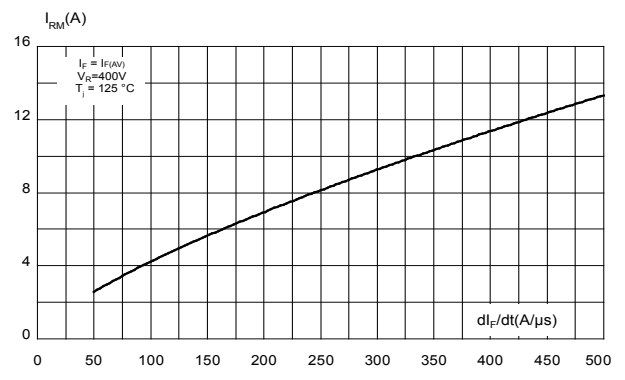

Figure 7. Reverse recovery time versus di_F/dt (typical values)

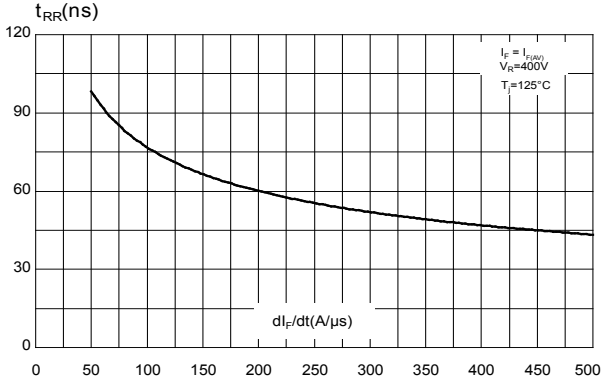

Figure 8. Reverse recovery charges versus di_F/dt (typical values)

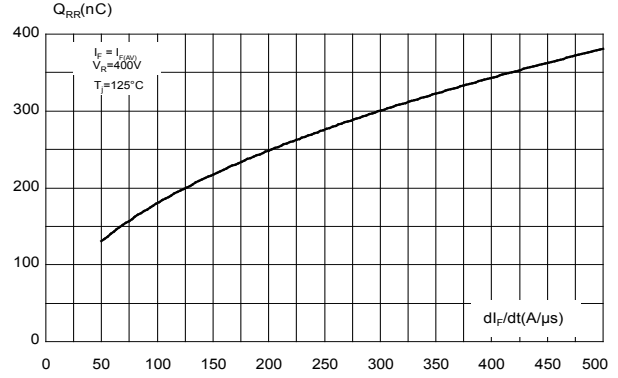

Figure 9. Reverse recovery softness factor versus di_F/dt (typical values)

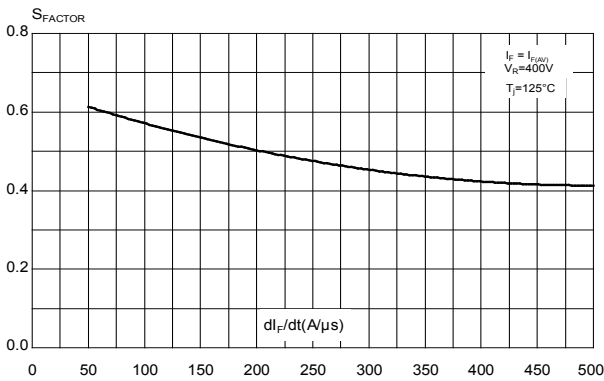

Figure 10. Relative variations of dynamic parameters versus junction temperature

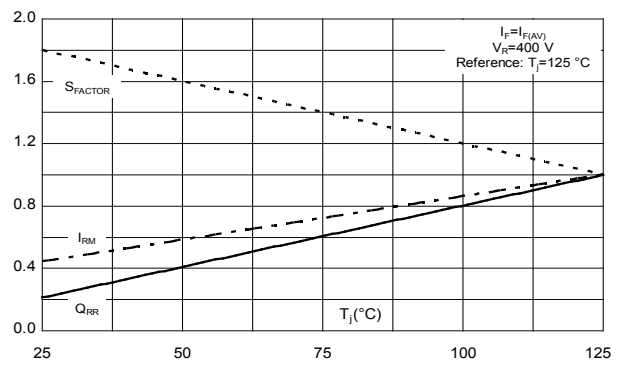

Figure 11. Junction capacitance versus reverse voltage applied (typical values)

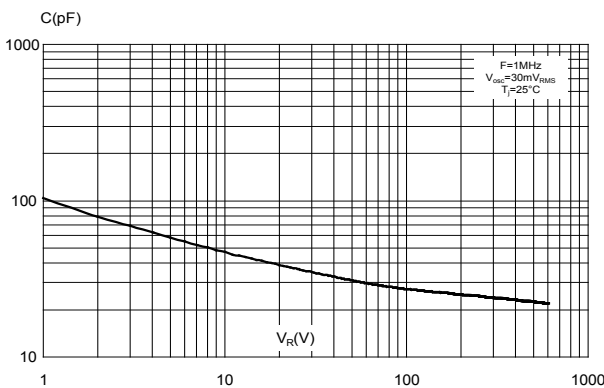

Figure 12. Thermal resistance junction to ambient versus copper surface under tab (typical values, epoxy printed board FR4, $e_{Cu} = 70 \mu m$)

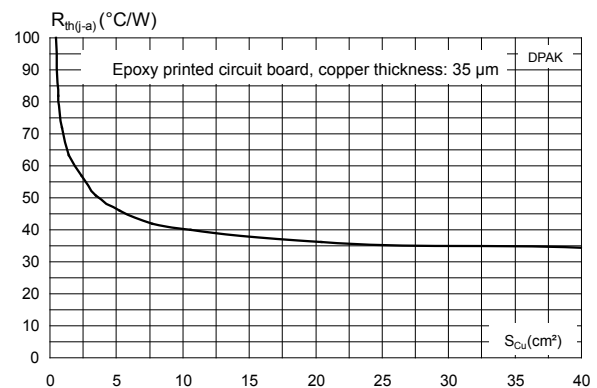

Figure 13. Relative variation of non-repetitive peak surge forward current versus pulse duration (sinusoidal waveform)

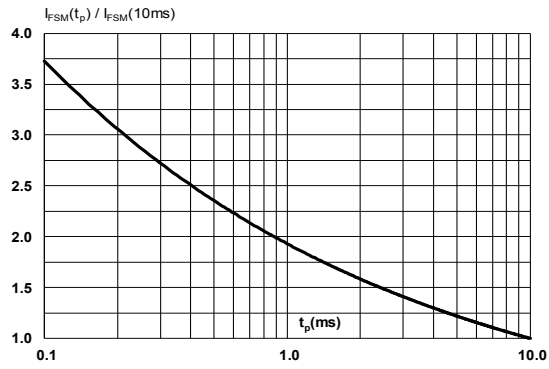
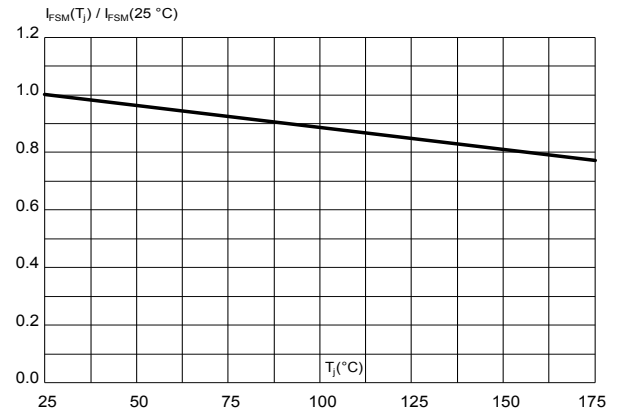

Figure 14. Relative variation of non-repetitive peak surge forward current versus initial junction temperature (sinusoidal waveform)



2 Package information

In order to meet environmental requirements, ST offers these devices in different grades of **ECOPACK** packages, depending on their level of environmental compliance. ECOPACK specifications, grade definitions and product status are available at: www.st.com. ECOPACK is an ST trademark.

2.1 DPAK package information

- Epoxy meets UL 94, V0
- Cooling method: by conduction (C)

Figure 15. DPAK package outline

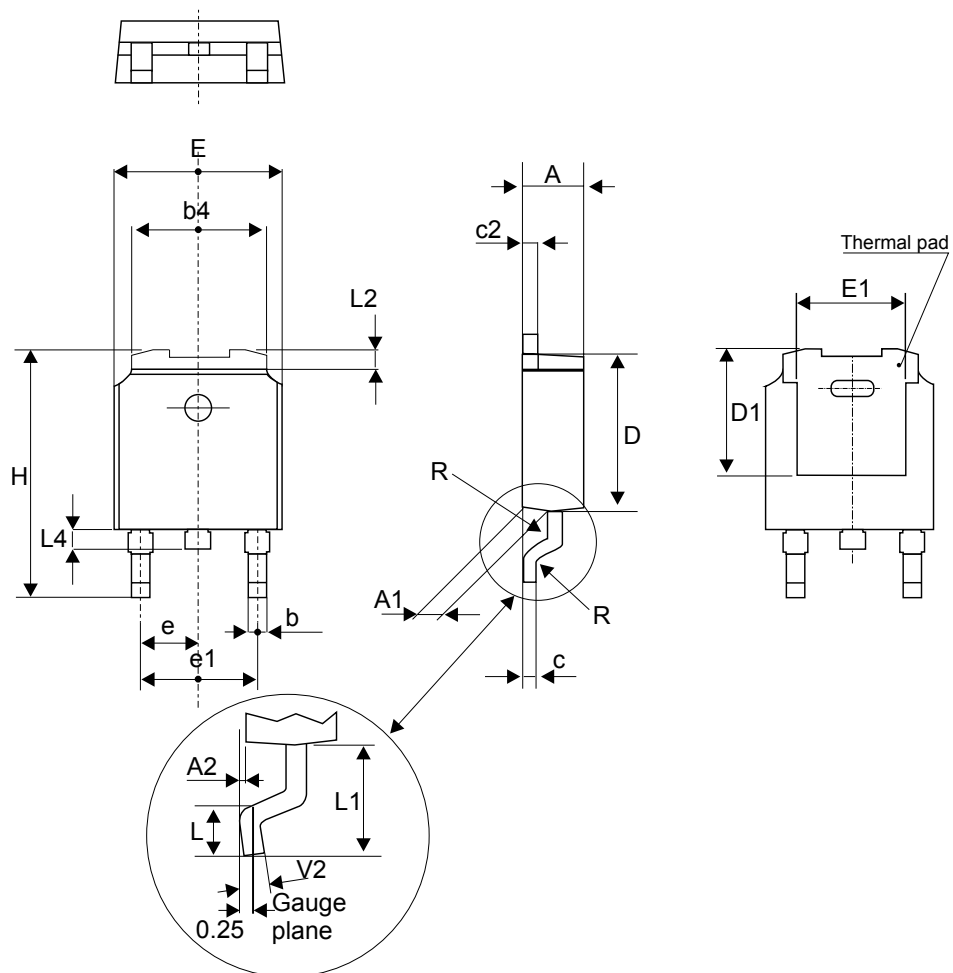

Note: This package drawing may slightly differ from the physical package. However, all the specified dimensions are guaranteed.

Table 5. DPAK package mechanical data

Ref.	Dimensions			
	Millimeters		Inches (for reference only)	
	Min.	Max.	Min.	Max.
A	2.18	2.40	0.085	0.094
A1	0.90	1.10	0.035	0.043
A2	0.03	0.23	0.001	0.009
b	0.64	0.90	0.025	0.035
b4	4.95	5.46	0.194	0.215
c	0.46	0.61	0.018	0.024
c2	0.46	0.60	0.018	0.023
D	5.97	6.22	0.235	0.244
D1	4.95	5.60	0.194	0.220
E	6.35	6.73	0.250	0.265
E1	4.32	5.50	0.170	0.216
e	2.286 typ.		0.090 typ.	
e1	4.40	4.70	0.173	0.185
H	9.35	10.40	0.368	0.409
L	1.0	1.78	0.039	0.070
L2		1.27		0.050
L4	0.60	1.02	0.023	0.040
V2	-8°	+8°	-8°	+8°

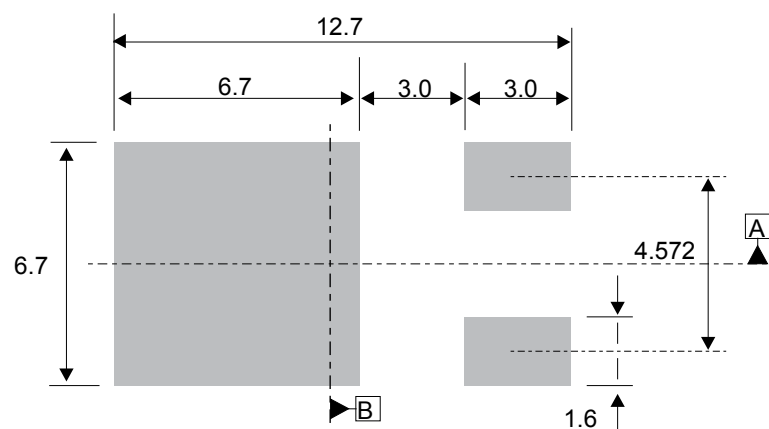
Figure 16. DPAK recommended footprint (dimensions in mm)

The device must be positioned within $\oplus 0.05$ AB

2.2 TO-220FPAC package information

- Epoxy meets UL 94,V0
- Cooling method: by conduction (C)
- Recommended torque value: 0.55 N·m
- Maximum torque value: 0.70 N·m

Figure 17. TO-220FPAC package outline

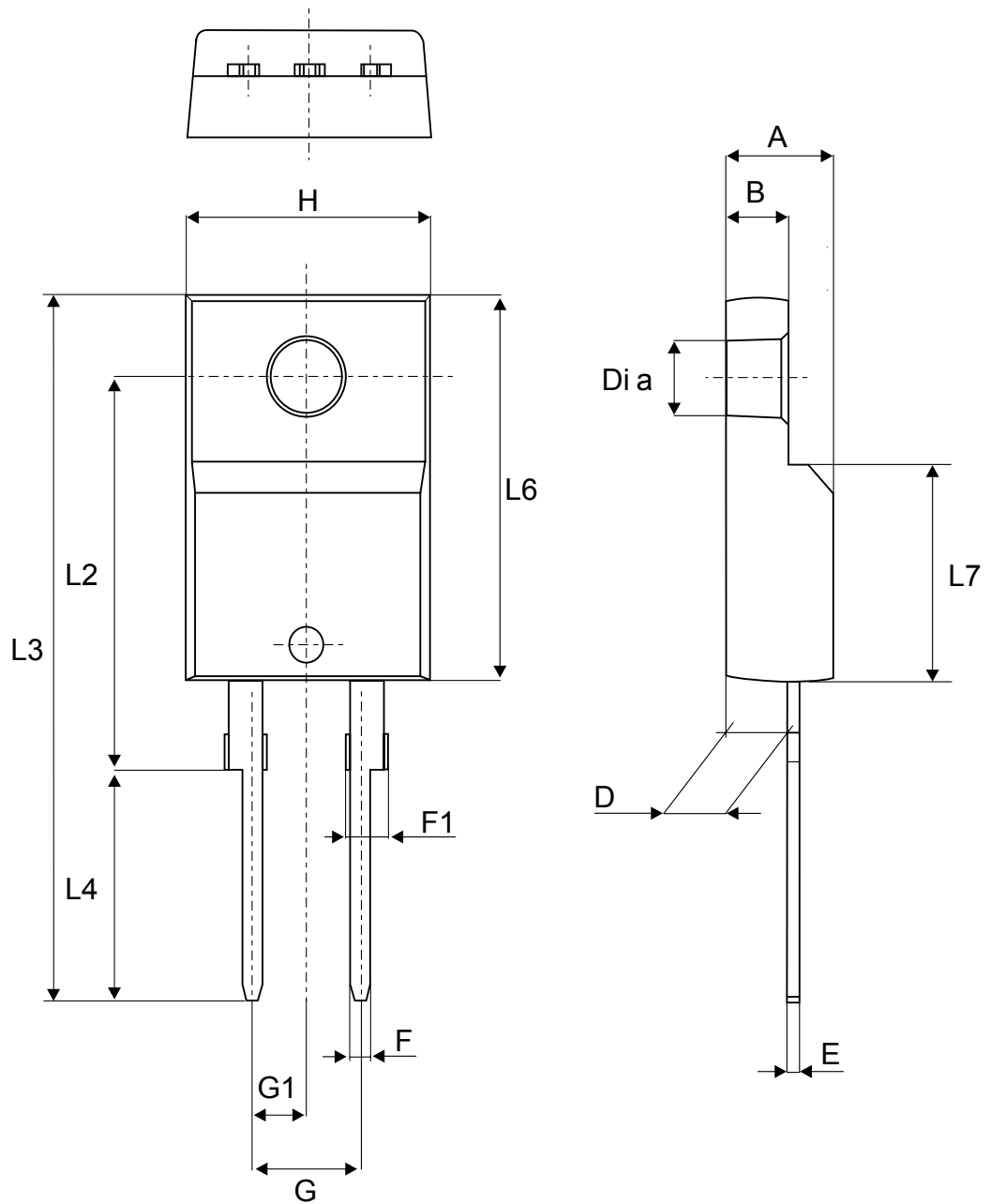

Table 6. TO-220FPAC package mechanical data

Ref.	Dimensions			
	Millimeters		Inches (for reference only)	
	Min.	Max.	Min.	Max.
A	4.40	4.60	0.173	0.181
B	2.5	2.7	0.098	0.106
D	2.5	2.75	0.098	0.108
E	0.45	0.70	0.018	0.027
F	0.75	1	0.030	0.039
F1	1.15	1.70	0.045	0.067
G	4.95	5.20	0.195	0.205
G1	2.4	2.7	0.094	0.106
H	10	10.4	0.393	0.409
L2	16 typ.		0.63 typ.	
L3	28.6	30.6	1.126	1.205
L4	9.8	10.6	0.386	0.417
L6	15.9	16.4	0.626	0.646
L7	9.00	9.30	0.354	0.366
Diam	3.00	3.20	0.118	0.126

3 Ordering information

Table 7. Ordering information

Order code	Marking	Package	Weight	Base qty.	Delivery mode
STTH25M06B-TR	TH25 M06B	DKAK	0.32 g	2500	Tape and reel
STTH25M06FP	STTH25M06FP	TO-220FPAC	1.90 g	50	Tube

Revision history

Table 8. Document revision history

Date	Revision	Changes
09-Dec-2019	1	Initial release.
10-Feb-2020	2	Added TO-220FPAC package information.

IMPORTANT NOTICE – PLEASE READ CAREFULLY

STMicroelectronics NV and its subsidiaries (“ST”) reserve the right to make changes, corrections, enhancements, modifications, and improvements to ST products and/or to this document at any time without notice. Purchasers should obtain the latest relevant information on ST products before placing orders. ST products are sold pursuant to ST’s terms and conditions of sale in place at the time of order acknowledgement.

Purchasers are solely responsible for the choice, selection, and use of ST products and ST assumes no liability for application assistance or the design of Purchasers’ products.

No license, express or implied, to any intellectual property right is granted by ST herein.

Resale of ST products with provisions different from the information set forth herein shall void any warranty granted by ST for such product.

ST and the ST logo are trademarks of ST. For additional information about ST trademarks, please refer to www.st.com/trademarks. All other product or service names are the property of their respective owners.

Information in this document supersedes and replaces information previously supplied in any prior versions of this document.

© 2020 STMicroelectronics – All rights reserved