

Stamped Metal Niche UWB



AANI-NI-0014

Request Samples



Check Inventory



5.50 x 3.90 x 0.49 mm
RoHS/RoHS II Compliant
MSL Level = 1

Features

- Cost Effective
- Low profile antenna integrated along PCB edge
- Robust performance even when employed in solutions requiring “potting/coating/over-mold”
- Based on Technology Patented by Abracon
- Highly efficient
- Wide Coverage: 6.24 – 8.74 GHz
- Low Return Loss: < -7.4 dB

Applications

- Applications utilizing UWB Channels 5, 6, 8, 9, and 10 (6.24 - 8.74 GHz)
- Wireless Remote Control
- Real-Time Location
- Digital Keys
- Hands-Free Payment
- Indoor Navigation
- Object Detection

Technology is based on Abracon’s intellectual property.

Option: For high volumes (EAU 100k+) see the cost-effective Niche Licensed Product PN: ANU

Product Image

The Stamped Metal Niche UWB antenna:

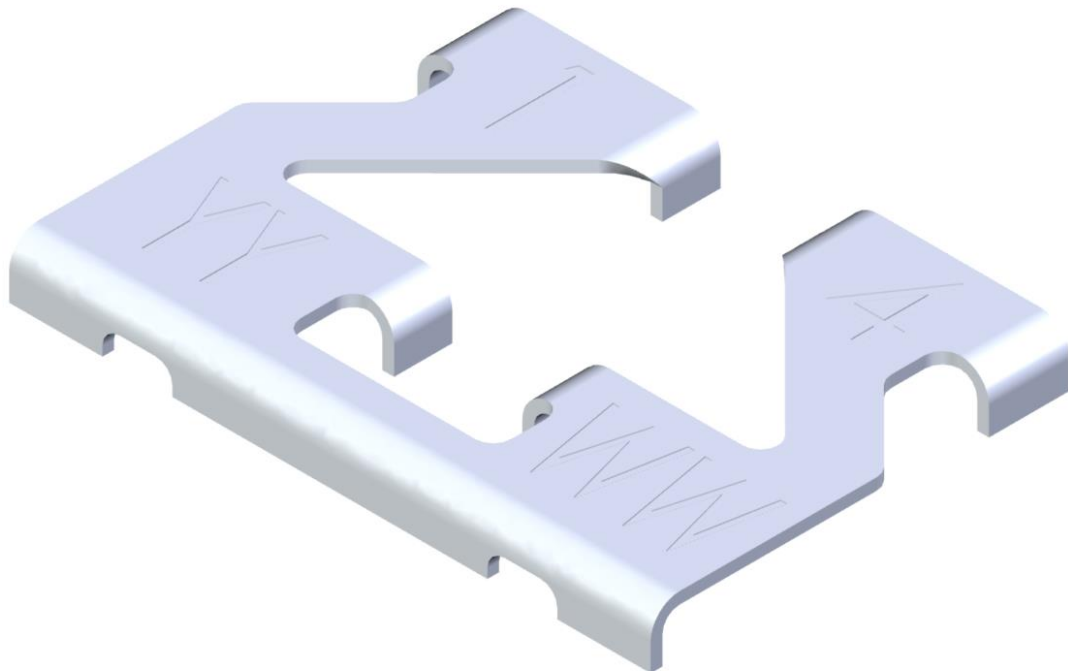



AANI-NI-0014

Request Samples



Check Inventory



5.50 x 3.90 x 0.49 mm
RoHS/RoHS II Compliant
MSL Level = 1

Electrical Specification

Parameter	Specification					Unit
	5	6	8	9	10	
UWB Channel	5	6	8	9	10	-
Operating Frequency	6240 - 6739	6739 - 7238	7238 - 7738	7738 - 8237	8237 - 8736	MHz
Return Loss	< -8.9	< -7.5	< -7.4	< -7.7	< -9.1	dB
Polarization	Linear					-
Peak Gain	2.8	3.4	2.2	2.5	2.8*	dBi
Efficiency	> -1.9 (65)	> -2.0 (63)	> -2.1 (62)	> -2.6 (55)	> -2.3 (59)*	dB (%)
Impedance	50					Ω

Note: All measurements were conducted on the evaluation board in free space. Performance will vary depending on the ground plane, application, and environment.

**Channel 10 radiation measurements (efficiency/gain) are limited to a maximum measured frequency of 8500 MHz.*

Mechanical Specification

Parameter	Specification
Antenna Dimension	5.50 x 3.90 x 0.49 mm
Evaluation Board Ground Plane Dimensions	15 x 20 mm
Mounting Type	Surface Mount

Product Dimensions

The Stamped Metal Niche antenna is 5.50 x 3.90 x 0.49 mm in size. Drawing is shown by first angle projection:

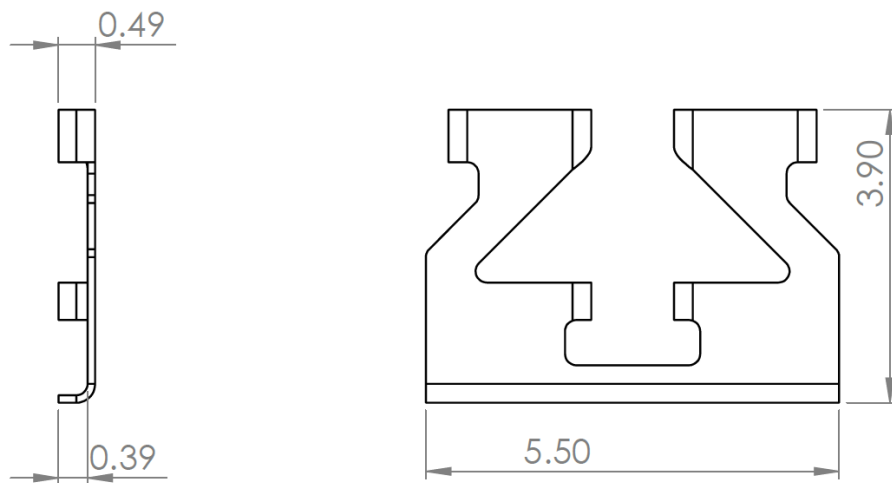

Unit: mm



AANI-NI-0014

Request Samples



Check Inventory



5.50 x 3.90 x 0.49 mm
RoHS/RoHS II Compliant
MSL Level = 1

Antenna Footprint

The dimensions of the copper cutout and solder pad positions are shown in the image below. The antenna and the footprint are symmetrical. This means that the antenna can be fed from either side (from the left in the example).

For a detailed antenna footprint example: <https://abracon.com/Support/Footprint/AANI-NI-0014-EVB-Footprint.zip>

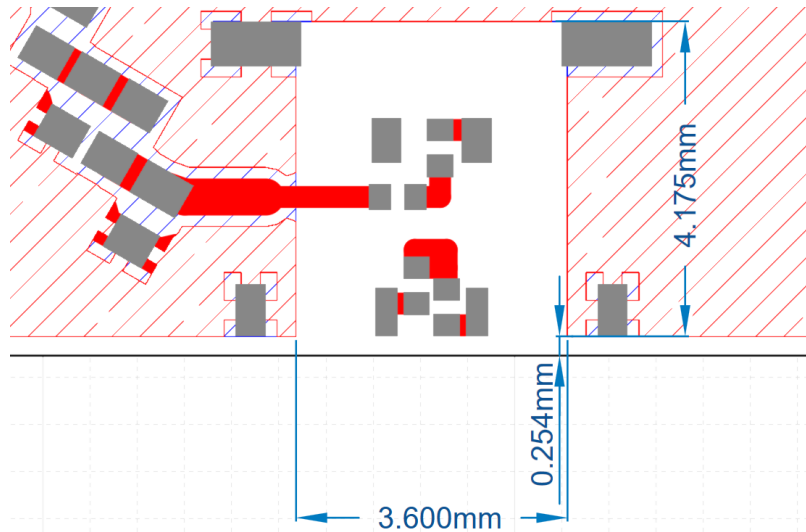

Antenna Pin Numbering

The antenna should be mounted on a ground (GND) plane, keeping the correct clearance area(s). If there are several layers in the PCB, there is an advantage to add vias for smooth interconnection of the ground areas to avoid splits in the ground plane. It is also important that there is ground clearance around the non-connected (NC) pads, through all layers of the PCB. Thanks to symmetry, the antenna can be fed on either pad 3 or 4. Pads 6 and 7 are connected via top load capacitors. Thermal relief connections can be utilized on the GND pads.

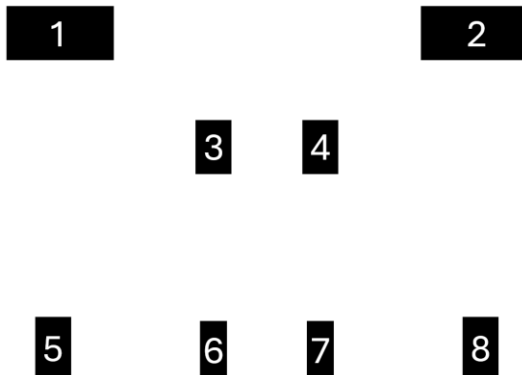

Pin	Feeding from the Left	Feeding from the Right
1	GND	NC
2	NC	GND
3	NC	RF-feed
4	RF-feed	NC
5	GND	GND
6	Top Load	Top Load
7	Top Load	Top Load
8	GND	GND



AANI-NI-0014

Request Samples



Check Inventory



5.50 x 3.90 x 0.49 mm
RoHS/RoHS II Compliant
MSL Level = 1

Measurement Setup

The antenna measurements were all done in free space, with the Stamped Metal Niche UWB antenna implemented on its evaluation board that has a PCB size of 15 by 20 (X by Y) mm.

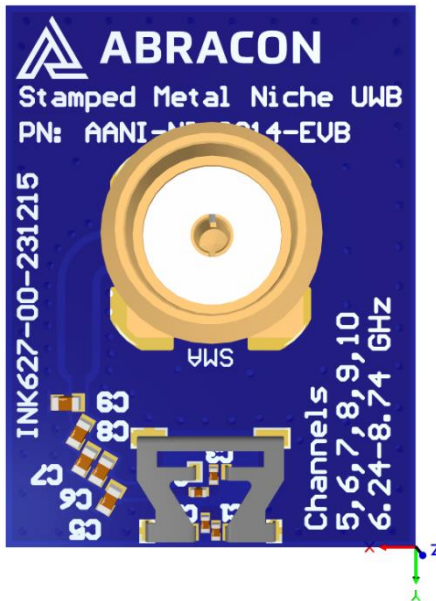

Reflection Characteristics – Return Loss

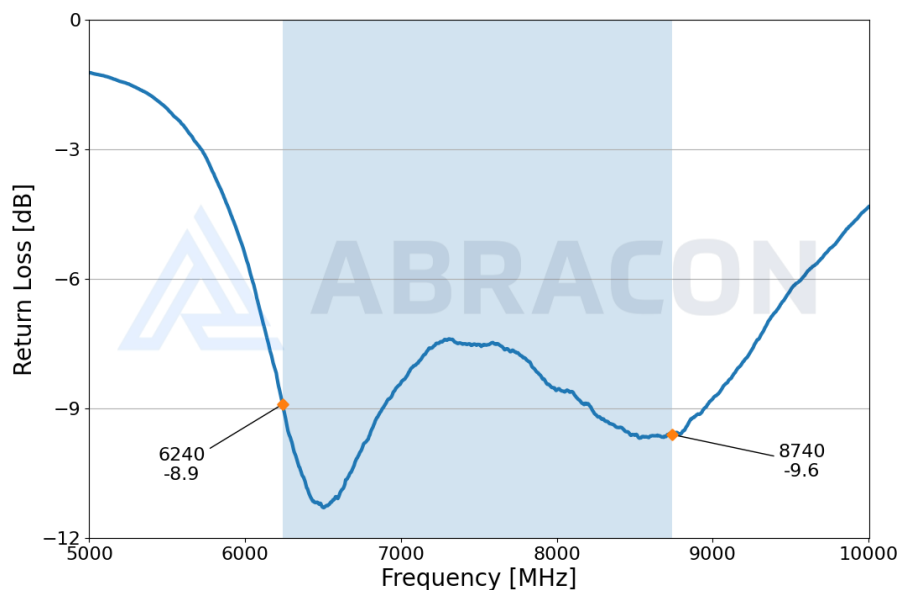



AANI-NI-0014

Request Samples



Check Inventory



5.50 x 3.90 x 0.49 mm
RoHS/RoHS II Compliant
MSL Level = 1

Radiation Characteristics – Total Efficiency

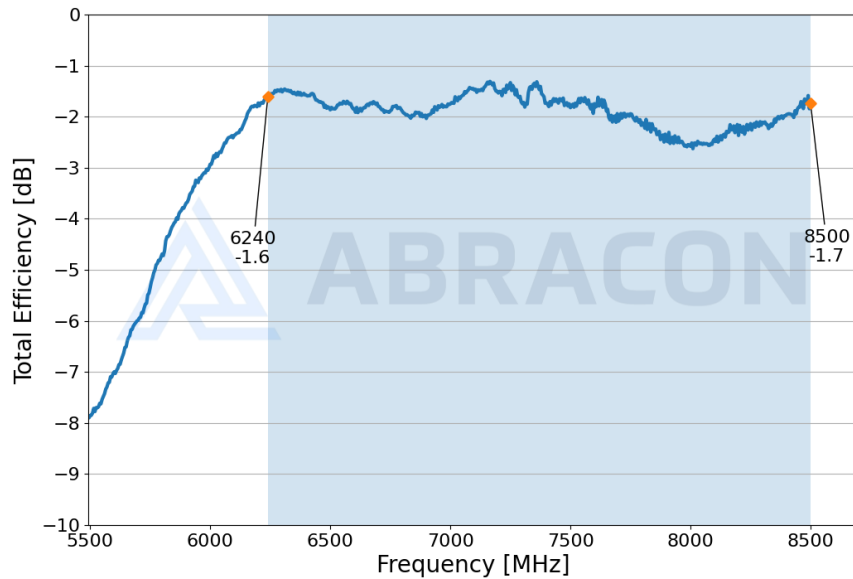

Radiation Characteristics – Maximum Gain

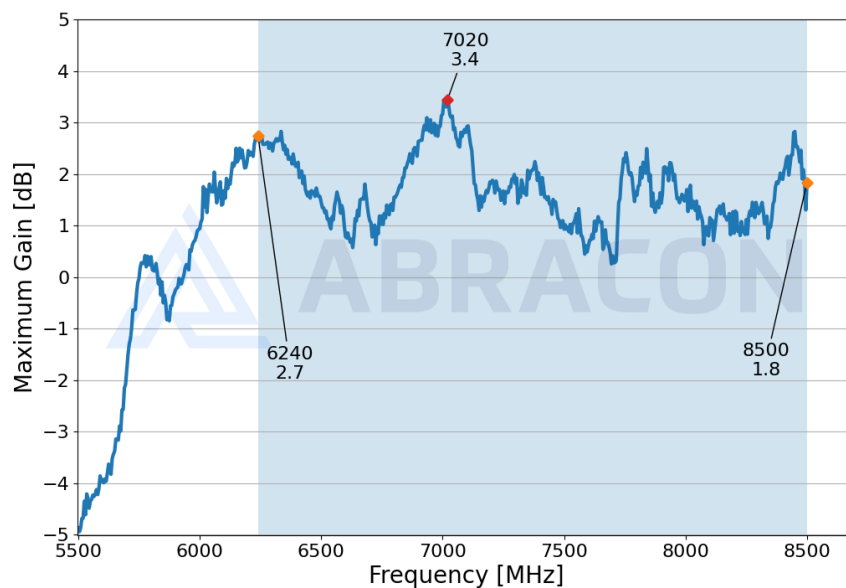

Stamped Metal Niche UWB



AANI-NI-0014

Request Samples



Check Inventory



5.50 x 3.90 x 0.49 mm
RoHS/RoHS II Compliant
 MSL Level = 1

Radiation Characteristics – 2D Pattern @ 6250 MHz

XY-plane:

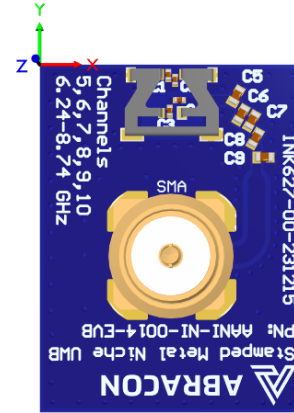
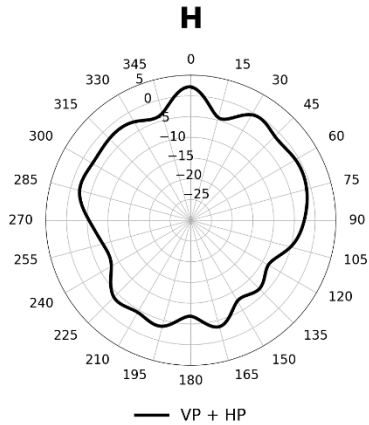

YZ-plane:

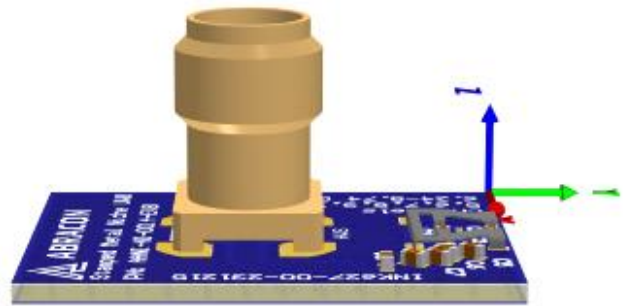
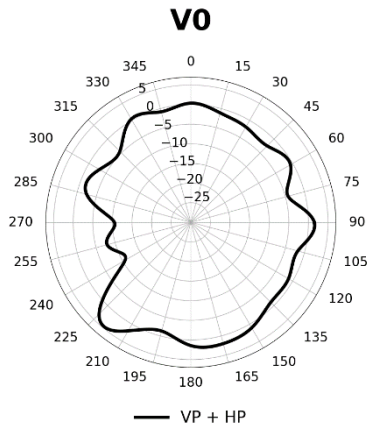

XZ-plane:

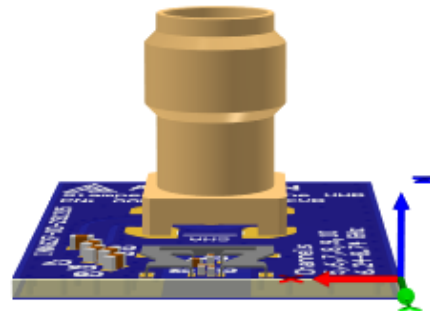
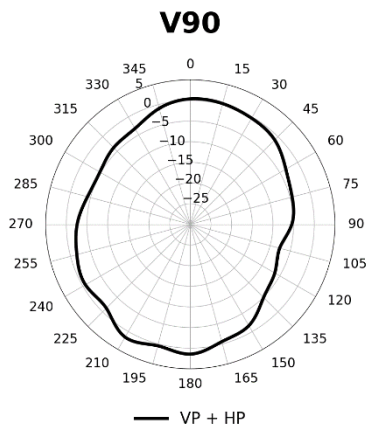

VP: Vertical Polarization
 HP: Horizontal Polarization

Unit: dBi



5101 Hidden Creek Ln Spicewood TX 78669
 Phone: 512-371-6159 | Fax: 512-351-8858
 For terms and conditions of sales, please visit:
www.abracon.com

REVISED: 04-26-24

ABRACON IS
 ISO9001-2015
 CERTIFIED

Stamped Metal Niche UWB



AANI-NI-0014

Request Samples



Check Inventory



5.50 x 3.90 x 0.49 mm
RoHS/RoHS II Compliant
 MSL Level = 1

Radiation Characteristics – 2D Pattern @ 6750 MHz

XY-plane:

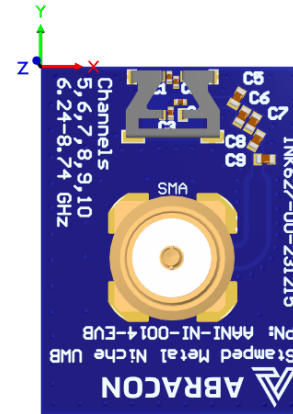
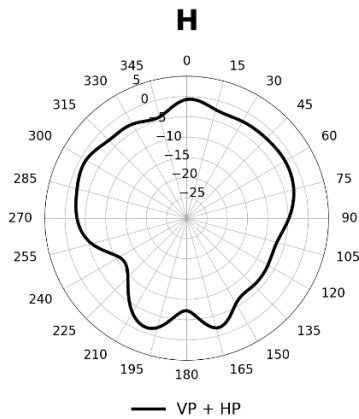

YZ-plane:

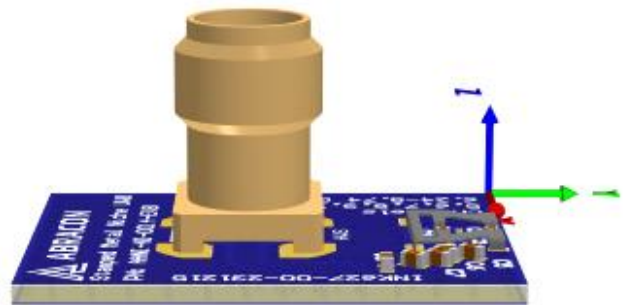
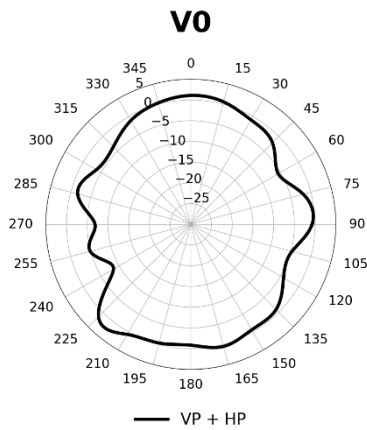

XZ-plane:

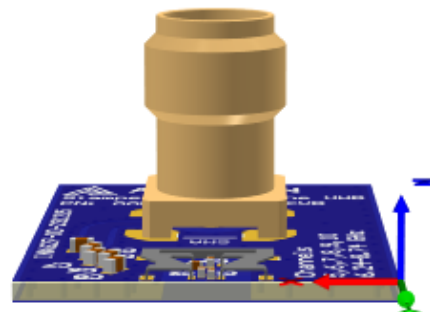
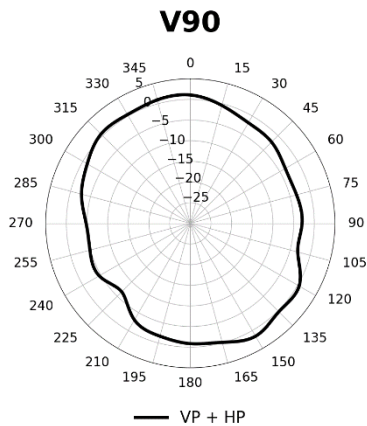

VP: Vertical Polarization
 HP: Horizontal Polarization

Unit: dBi



5101 Hidden Creek Ln Spicewood TX 78669
 Phone: 512-371-6159 | Fax: 512-351-8858
 For terms and conditions of sales, please visit:
www.abracon.com

REVISED: 04-26-24

ABRACON IS
 ISO9001-2015
 CERTIFIED

Stamped Metal Niche UWB



AANI-NI-0014

Request Samples



Check Inventory



5.50 x 3.90 x 0.49 mm
RoHS/RoHS II Compliant
 MSL Level = 1

Radiation Characteristics – 2D Pattern @ 8250 MHz

XY-plane:

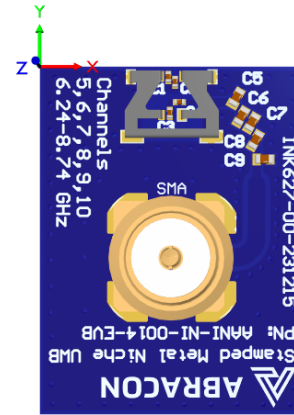
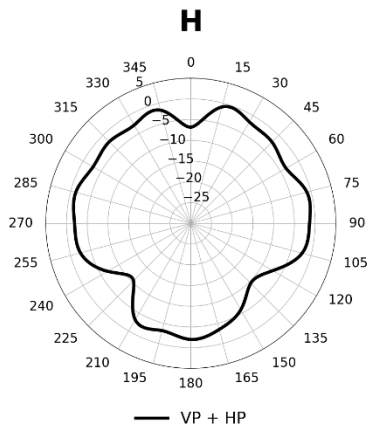

YZ-plane:

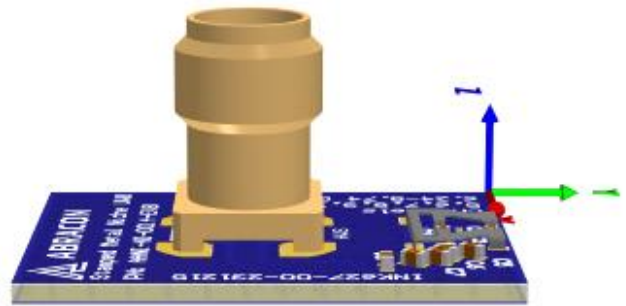
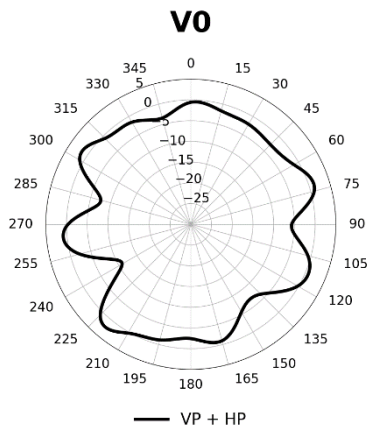

XZ-plane:

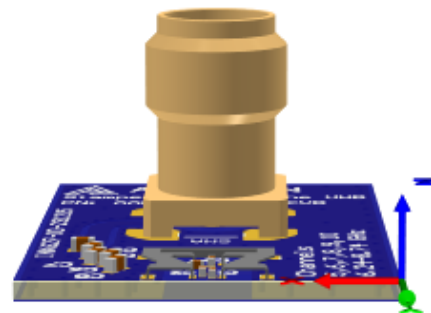
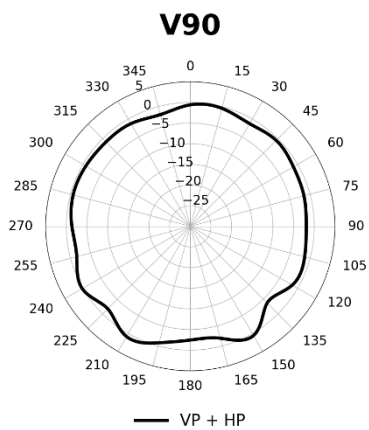

VP: Vertical Polarization
 HP: Horizontal Polarization

Unit: dBi



5101 Hidden Creek Ln Spicewood TX 78669
 Phone: 512-371-6159 | Fax: 512-351-8858
 For terms and conditions of sales, please visit:
www.abracon.com

REVISED: 04-26-24

ABRACON IS
 ISO9001-2015
 CERTIFIED

Stamped Metal Niche UWB



AANI-NI-0014

Request Samples



Check Inventory



5.50 x 3.90 x 0.49 mm
RoHS/RoHS II Compliant
MSL Level = 1

Radiation Characteristics – 3D Pattern

6250 MHz

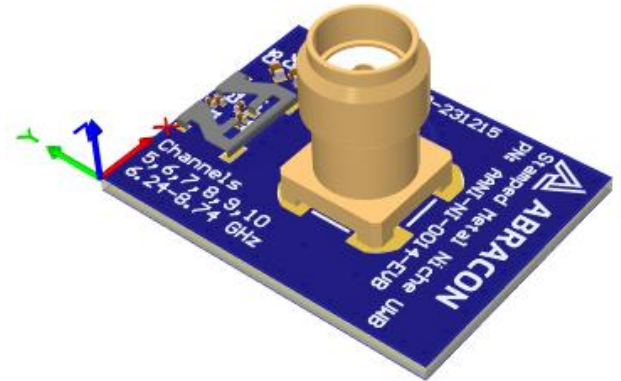
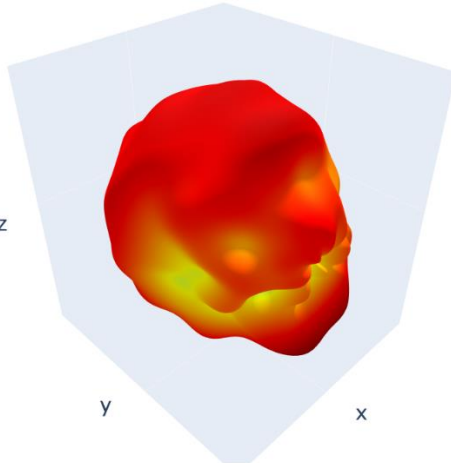

6750 MHz

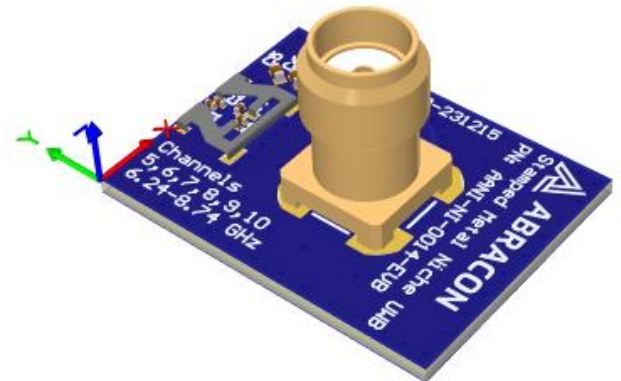
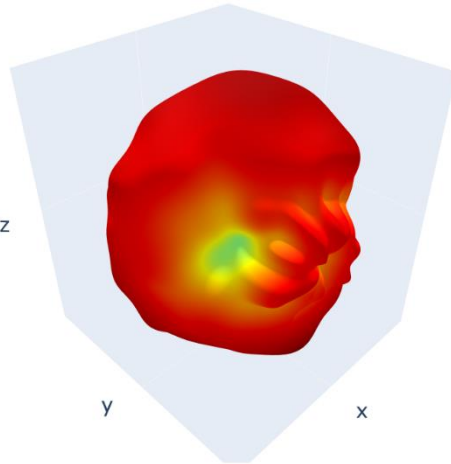

8250 MHz

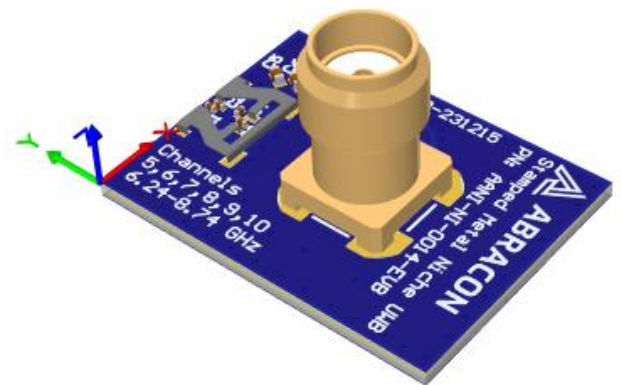
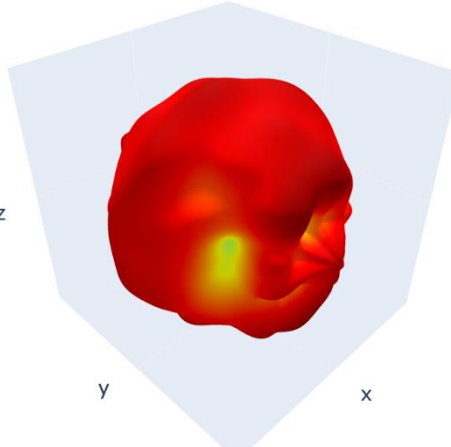

5101 Hidden Creek Ln Spicewood TX 78669
Phone: 512-371-6159 | Fax: 512-351-8858
For terms and conditions of sales, please visit:
www.abracon.com

REVISED: 04-26-24

ABRACON IS
ISO9001-2015
CERTIFIED



AANI-NI-0014

Request Samples



Check Inventory



5.50 x 3.90 x 0.49 mm
RoHS/RoHS II Compliant
 MSL Level = 1

Evaluation Board Outline & Matching Circuit

The evaluation board (Abracon P/N: AANI-NI-0014-EVB) is developed to showcase the performance of the Stamped Metal Niche UWB antenna on a typical PCB and to simplify antenna testing and evaluation. It has a ground plane size of 15 x 20 mm and includes an SMA connector. The performance will vary with different PCB sizes. Abracon can offer support to optimize the antenna for specific applications.

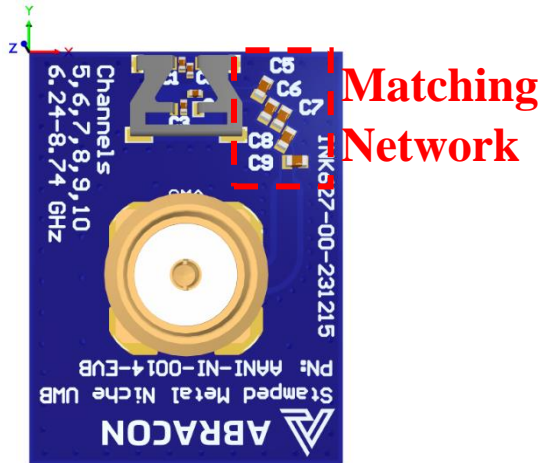

The evaluation board has a matching circuit implemented next to the antenna to enable optimization possibilities for the user. The C1-C4 component footprints are sized for 0201 (0603 metric) SMD components. The matching network (C5-C9) component footprints are sized for 0402 (1005 metric) SMD components.

The standard tuning for the evaluation board is the following (can be replaced by equivalent):

- C1, C2 = 0.1 pF (Murata GRM0335C1HR10WA01)
- C3, C4 = 0.4 pF (Murata GJM0335C1HR40WB01)
- C5, C7, C9 = Not Mounted
- C6, C8 = Zero Ohm (KOA Speer RK73Z1ETTP)

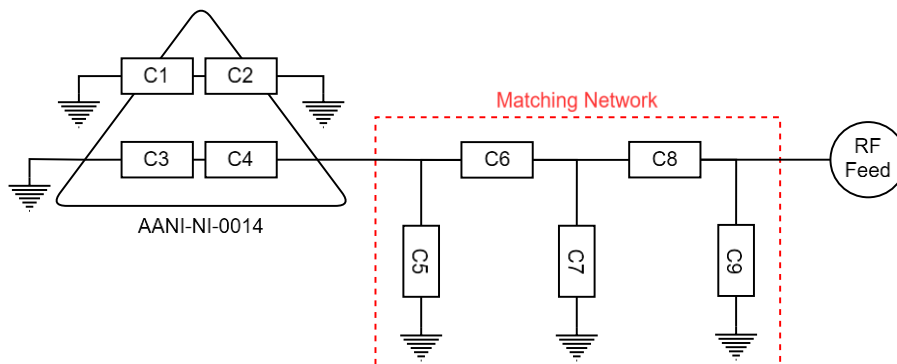

However, it is common that the resonant frequency will shift during implementation in an arbitrary device. Therefore, this matching may be changed with other values/components/brands for compensation of such effects. This is further described in the General Implementation Guidelines section below.



AANI-NI-0014

Request Samples



Check Inventory



5.50 x 3.90 x 0.49 mm
RoHS/RoHS II Compliant
MSL Level = 1

General Implementation Guidelines for the Stamped Metal Niche Antenna

The antenna can be positioned in different ways, although there are some positions which are more beneficial. The left picture shows a typical PCB with examples on different antenna positions. The antenna must be placed along the PCB edge, i.e., it cannot be placed in the middle of the ground plane.

The optimal position is option 3 for a 15 x 20 mm PCB. Option 2 may be the best option for much larger PCBs (>> 15 x 20 mm) and option 1 for smaller PCBs (< 15 x 20 mm).

Antenna Positions:

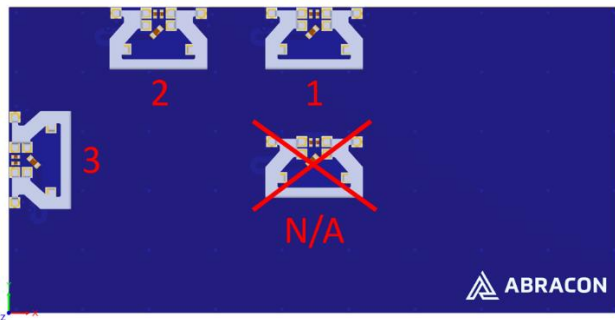

Antenna cutout & via-structure:

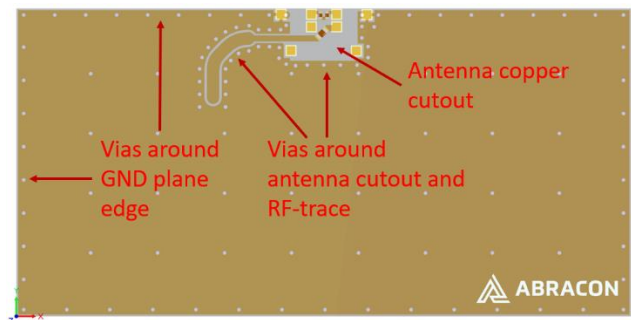

The rectangular copper cutout in the footprint needs to go through all the layers in the PCB stackup, meaning that there cannot be copper on any layer in this area. It is also recommended to have a good via-structure around the cutout and the edge of the ground plane, see the right image above.

It shall also be highlighted that plastic and metal parts in the near proximity of antennas may influence the antenna tuning and/or performance. This aspect should be noted as a general guideline for all antennas. The effects are difficult to estimate without detailed information, but it is common that a plastic housing above the antenna shifts the resonant frequency down. It is recommended to measure the antenna in the actual device after implementation and to implement a matching network on the antenna feed to adjust for the potential frequency shift.

The Stamped Metal Niche antenna shows great performance when potted compared to other antenna solutions and has also shown good performance in proximity of metal and other harsh antenna environments.

Part Marking

The top marking of the antenna is arranged according to the following illustration:

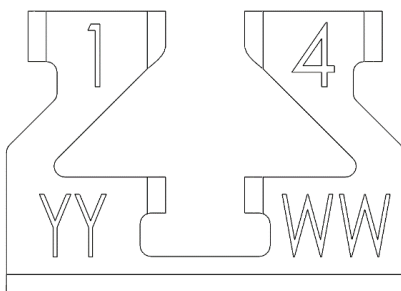

“YYWW” is the date code:

YY = Year

WW = Week

“1 4” is the product ID (AANI-NI-0014)



AANI-NI-0014

Request Samples



Check Inventory



5.50 x 3.90 x 0.49 mm
RoHS/RoHS II Compliant
MSL Level = 1

Packaging Information

The antenna is delivered on tape and reel according to the following specifications.

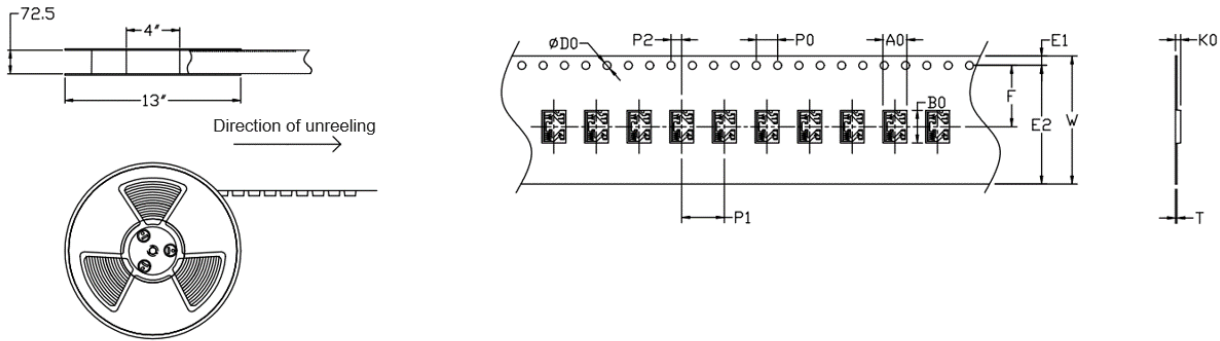

1. 10 sprocket hole pitch cumulative tolerance ± 0.2
2. Camber not to exceed 1mm in 100mm
3. A0 and B0 measured on a plane 0.30mm above the bottom of the pocket
4. K0 measured from a plane on the inside bottom of the pocket to the top surface of the carrier .
5. pocket position relative to sprocket hole measured as true position of pocket, not pocket hole.
6. Component load per 13" reel: 5240 pcs
7. Packing: specification follow the norm EIA-481

A ₀	4.50 ±0.1
B ₀	6.10 ±0.1
D ₀	∅1.5 ^{+0.10} _{-0.00}
E ₁	1.75 ±0.1
F	11.5 ±0.15
K ₀	1.0 ±0.1
P ₀	4.0 ±0.1
P ₁	8.0 ±0.1
P ₂	2.0 ±0.15
T	0.35 ±0.05
W	16.0 ±0.3

Unit: mm (unless otherwise noted)

Carton box size: 35 x 35 x 40cm

No. of reel per box: 13 reels

Weight per box: about 7.0kg

Qty per box: 68120pcs

ATTENTION: Abracon LLC's products are Commercial-Off-The-Shelf ("COTS"), which are designed, intended, and validated for use in commercial, industrial, and automotive applications. The customer is responsible for testing and verifying the performance of an Abracon solution to meet their system-level requirements.



5101 Hidden Creek Ln Spicewood TX 78669
 Phone: 512-371-6159 | Fax: 512-351-8858
 For terms and conditions of sales, please visit:
www.abracon.com

REVISED: 04-26-24

ABRACON IS
 ISO9001-2015
 CERTIFIED