

High Voltage, 600 V Automotive High and Low Side Driver

NCV5106A, NCV5106B

The NCV5106 is a high voltage gate driver IC providing two outputs for direct drive of 2 N-channel power MOSFETs or IGBTs arranged in a half-bridge configuration version B (version B on demand only) or any other high-side + low-side configuration version A.

It uses the bootstrap technique to ensure a proper drive of the high-side power switch. The driver works with 2 independent inputs.

Features

- High Voltage Range: Up to 600 V
- Automotive Qualified to AEC-Q100 – Grade 1
- dV/dt Immunity ± 50 V/nsec
- Negative Current Injection Characterized Over the Temperature Range
- Gate Drive Supply Range from 10 V to 20 V
- Output Source / Sink Current Capability 250 mA / 500 mA
- 3.3 V and 5 V Input Logic Compatible
- Up to V_{CC} Swing on Input Pins
- Extended Allowable Negative Bridge Pin Voltage Swing to -10 V for Signal Propagation
- Matched Propagation Delays Between Both Channels
- Outputs in Phase with the Inputs
- Independent Logic Inputs to Accommodate All Topologies (Version A)
- Cross Conduction Protection with 100 ns Internal Fixed Dead Time (Version B – on demand only)
- Under V_{CC} LockOut (UVLO) for Both Channels
- These are Pb-Free Devices

Typical Applications

- xEV Half-Bridge and Full-Bridge Converters
- 48 V Converters for HEV/EV
- Electric Power Steering



SOIC-8
 D SUFFIX
 CASE 751

MARKING DIAGRAMS

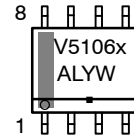

- V5106x = Specific Device Code
- x = A or B version
- A = Assembly Location
- L = Wafer Lot
- Y = Year
- W = Work Week
- = Pb-Free Package

PINOUT INFORMATION

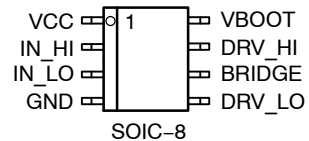

ORDERING INFORMATION

See detailed ordering and shipping information on page 16 of this data sheet.

NCV5106A, NCV5106B

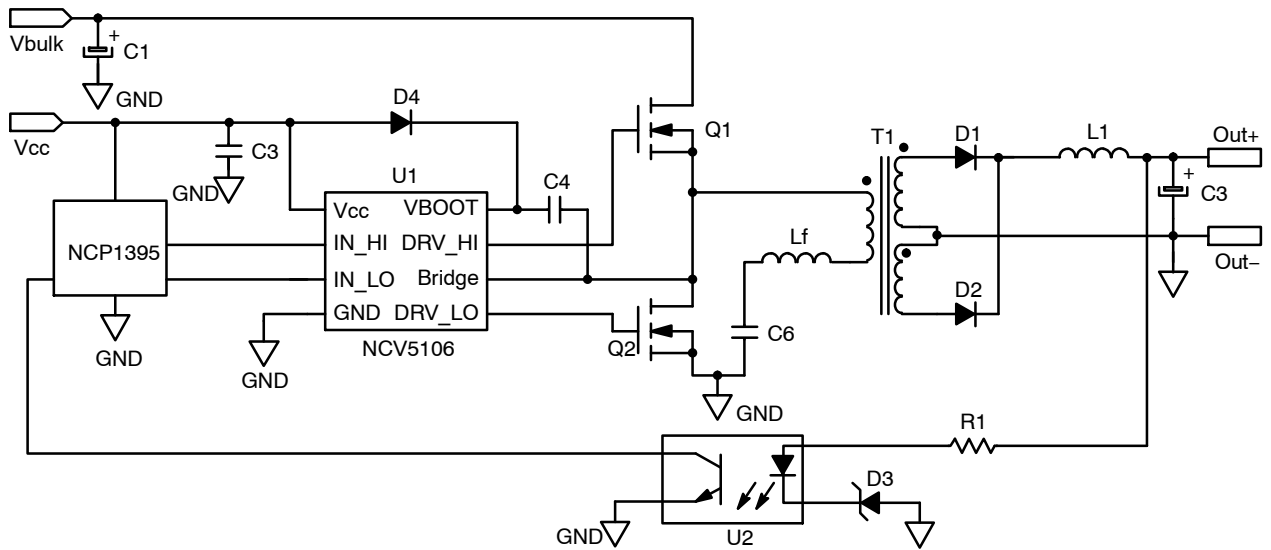

Figure 1. Typical Application Resonant Converter (LLC type)

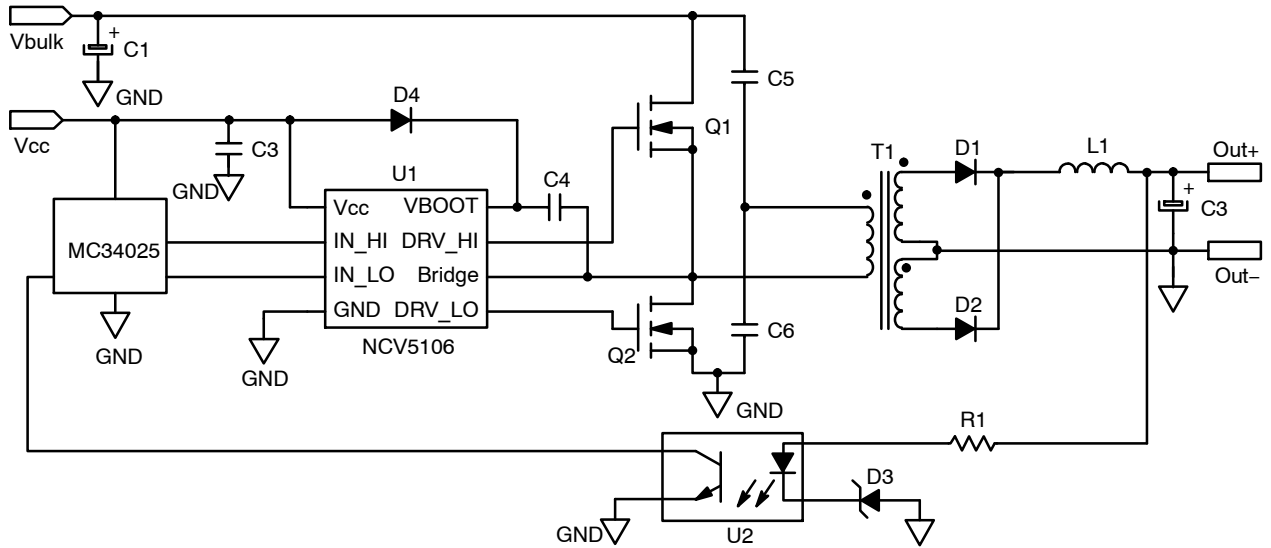

Figure 2. Typical Application Half Bridge Converter

NCV5106A, NCV5106B

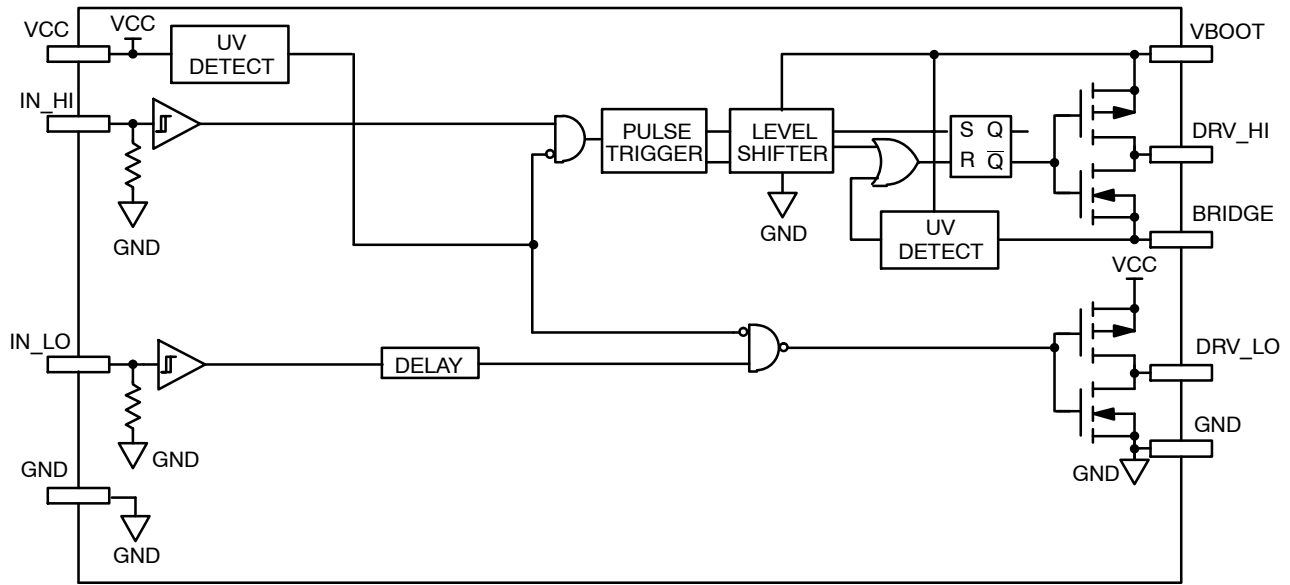

Figure 3. Detailed Block Diagram: Version A

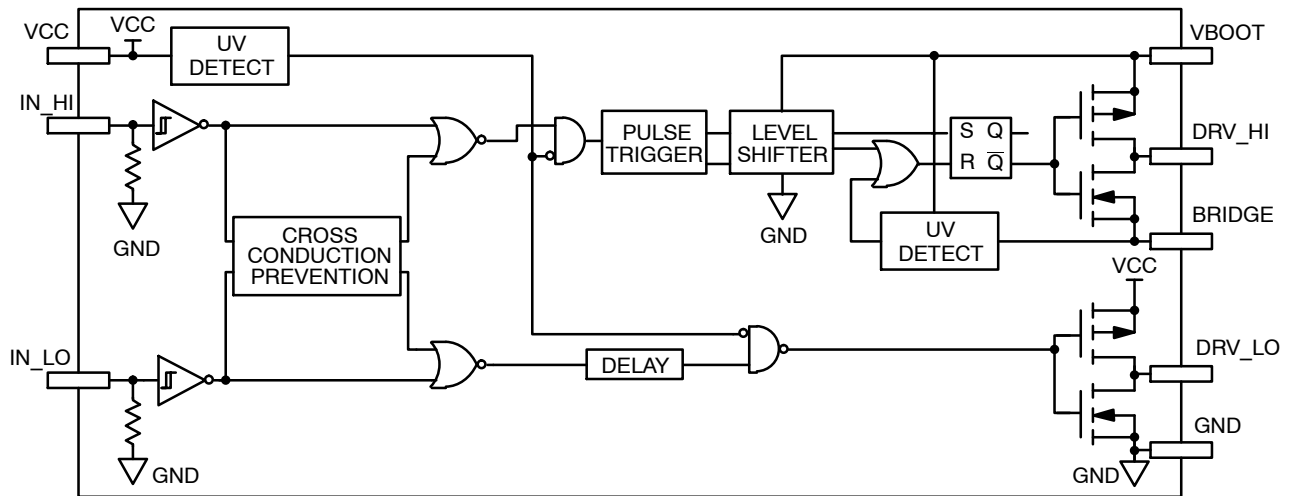

Figure 4. Detailed Block Diagram: Version B

PIN DESCRIPTION

Pin Name	Description
IN_HI	Logic Input for High Side Driver Output in Phase
IN_LO	Logic Input for Low Side Driver Output in Phase
GND	Ground
DRV_LO	Low Side Gate Drive Output
VCC	Low Side and Main Power Supply
VBOOT	Bootstrap Power Supply
DRV_HI	High Side Gate Drive Output
BRIDGE	Bootstrap Return or High Side Floating Supply Return
NC	Removed for creepage distance (DFN package only)

NCV5106A, NCV5106B

MAXIMUM RATINGS

Rating	Symbol	Value	Unit
V_{CC}	Main power supply voltage	-0.3 to 20	V
$V_{CC_transient}$	Main transient power supply voltage: $I_{V_{CC_max}} = 5\text{ mA}$ during 10 ms	23	V
V_{BRIDGE}	VHV: High Voltage BRIDGE pin	-1 to 600	V
V_{BRIDGE}	Allowable Negative Bridge Pin Voltage for IN_LO Signal Propagation to DRV_LO (see characterization curves for detailed results)	-10	V
$V_{BOOT_V_{BRIDGE}}$	VHV: Floating supply voltage	-0.3 to 20	V
V_{DRV_HI}	VHV: High side output voltage	$V_{BRIDGE} - 0.3$ to $V_{BOOT} + 0.3$	V
V_{DRV_LO}	Low side output voltage	-0.3 to $V_{CC} + 0.3$	V
dV_{BRIDGE}/dt	Allowable output slew rate	50	V/ns
V_{IN_XX}	Inputs IN_HI, IN_LO	-1.0 to $V_{CC} + 0.3$	V
	ESD Capability: - HBM Model (all pins) - CDM Model	750 1000	V V
	Latch up capability per JEDEC JESD78		
$R_{\theta JA}$	Power dissipation and Thermal characteristics SO-8: Thermal Resistance, Junction-to-Air	178	°C/W
T_{ST}	Storage Temperature Range	-55 to +150	°C
T_{J_max}	Maximum Operating Junction Temperature	+150	°C

Stresses exceeding those listed in the Maximum Ratings table may damage the device. If any of these limits are exceeded, device functionality should not be assumed, damage may occur and reliability may be affected.

NCV5106A, NCV5106B

ELECTRICAL CHARACTERISTIC ($V_{CC} = V_{boot} = 15\text{ V}$, $V_{GND} = V_{bridge}$, $-40^{\circ}\text{C} < T_J < 125^{\circ}\text{C}$, Outputs loaded with 1 nF)

Rating	Symbol	T _J -40°C to 125°C			Units
		Min	Typ	Max	

OUTPUT SECTION

Output high short circuit pulsed current $V_{DRV} = 0\text{ V}$, $PW \leq 10\ \mu\text{s}$ (Note 1)	$I_{DRVsource}$	-	250	-	mA
Output low short circuit pulsed current $V_{DRV} = V_{CC}$, $PW \leq 10\ \mu\text{s}$ (Note 1)	$I_{DRVsink}$	-	500	-	mA
Output resistor (Typical value @ 25°C) Source	R_{OH}	-	30	60	Ω
Output resistor (Typical value @ 25°C) Sink	R_{OL}	-	10	20	Ω
High level output voltage, $V_{BIAS} - V_{DRV_XX}$ @ $I_{DRV_XX} = 20\text{ mA}$	V_{DRV_H}	-	0.7	1.6	V
Low level output voltage V_{DRV_XX} @ $I_{DRV_XX} = 20\text{ mA}$	V_{DRV_L}	-	0.2	0.6	V

DYNAMIC OUTPUT SECTION

Turn-on propagation delay ($V_{bridge} = 0\text{ V}$)	t_{ON}	-	100	170	ns
Turn-off propagation delay ($V_{bridge} = 0\text{ V}$ or 50 V) (Note 2)	t_{OFF}	-	100	170	ns
Output voltage rise time (from 10% to 90% @ $V_{CC} = 15\text{ V}$) with 1 nF load	t_r	-	85	160	ns
Output voltage fall time (from 90% to 10% @ $V_{CC} = 15\text{ V}$) with 1 nF load	t_f	-	35	75	ns
Propagation delay matching between the High side and the Low side @ 25°C (Note 3)	Δt	-	20	35	ns
Internal fixed dead time (only valid for B version) (Note 4)	DT	65	100	190	ns
Minimum input width that changes the output	t_{PW1}	-	-	50	ns
Maximum input width that does not change the output	t_{PW2}	15	-	-	ns

INPUT SECTION

Low level input voltage threshold	V_{IN}	-	-	0.8	V
Input pull-down resistor ($V_{IN} < 0.5\text{ V}$)	R_{IN}	-	200	-	k Ω
High level input voltage threshold	V_{IN}	2.3	-	-	V
Logic "1" input bias current @ $V_{IN_XX} = 5\text{ V}$ @ 25°C	I_{IN+}	-	5	25	μA
Logic "0" input bias current @ $V_{IN_XX} = 0\text{ V}$ @ 25°C	I_{IN-}	-	-	2.0	μA

SUPPLY SECTION

V_{CC} UV Start-up voltage threshold	V_{CC_stup}	8.0	8.9	9.9	V
V_{CC} UV Shut-down voltage threshold	V_{CC_shtdwn}	7.3	8.2	9.1	V
Hysteresis on V_{CC}	V_{CC_hyst}	0.3	0.7	-	V
Vboot Start-up voltage threshold reference to bridge pin ($V_{boot_stup} = V_{boot} - V_{bridge}$)	V_{boot_stup}	8.0	8.9	9.9	V
Vboot UV Shut-down voltage threshold	V_{boot_shtdwn}	7.3	8.2	9.1	V
Hysteresis on Vboot	V_{boot_shtdwn}	0.3	0.7	-	V
Leakage current on high voltage pins to GND ($V_{BOOT} = V_{BRIDGE} = DRV_HI = 600\text{ V}$)	I_{HV_LEAK}	-	5	40	μA
Consumption in active mode ($V_{CC} = V_{boot}$, $f_{sw} = 100\text{ kHz}$ and 1 nF load on both driver outputs)	$ICC1$	-	4	5	mA
Consumption in inhibition mode ($V_{CC} = V_{boot}$)	$ICC2$	-	250	400	μA
V_{CC} current consumption in inhibition mode	$ICC3$	-	200	-	μA
Vboot current consumption in inhibition mode	$ICC4$	-	50	-	μA

- Parameter guaranteed by design.
 - Turn-off propagation delay @ $V_{bridge} = 600\text{ V}$ is guaranteed by design.
 - See characterization curve for Δt parameters variation on the full range temperature.
 - Version B integrates a dead time in order to prevent any cross conduction between DRV_HI and DRV_LO . See timing diagram of Figure 10.
 - Timing diagram definition see: Figure 7, Figure 8 and Figure 9.
- Product parametric performance is indicated in the Electrical Characteristics for the listed test conditions, unless otherwise noted. Product performance may not be indicated by the Electrical Characteristics if operated under different conditions.

NCV5106A, NCV5106B

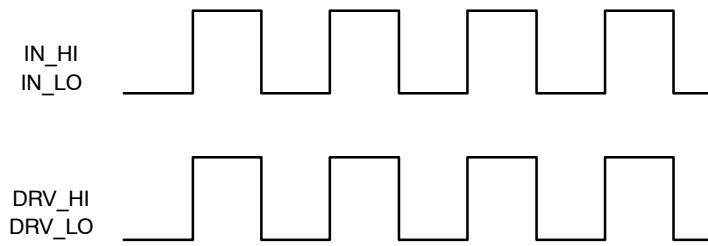

Figure 5. Input/Output Timing Diagram (A Version)

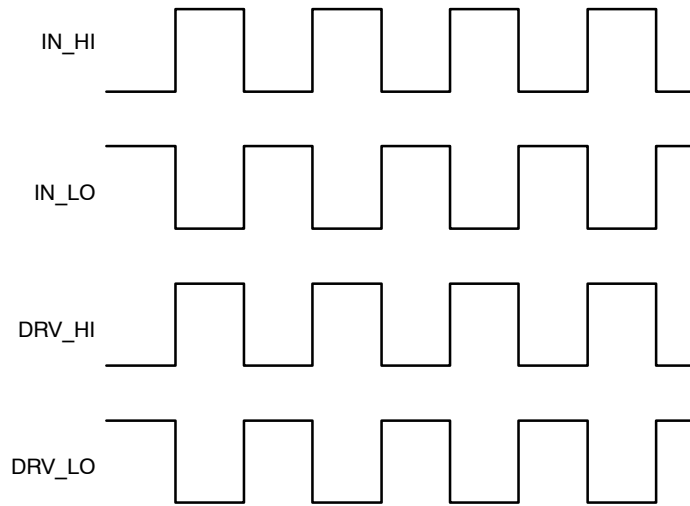

Figure 6. Input/Output Timing Diagram (B Version)

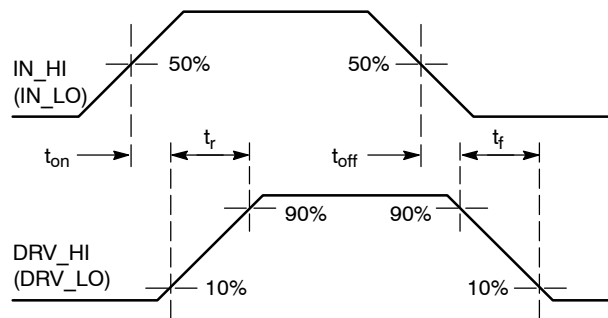

Figure 7. Propagation Delay and Rise / Fall Time Definition

NCV5106A, NCV5106B

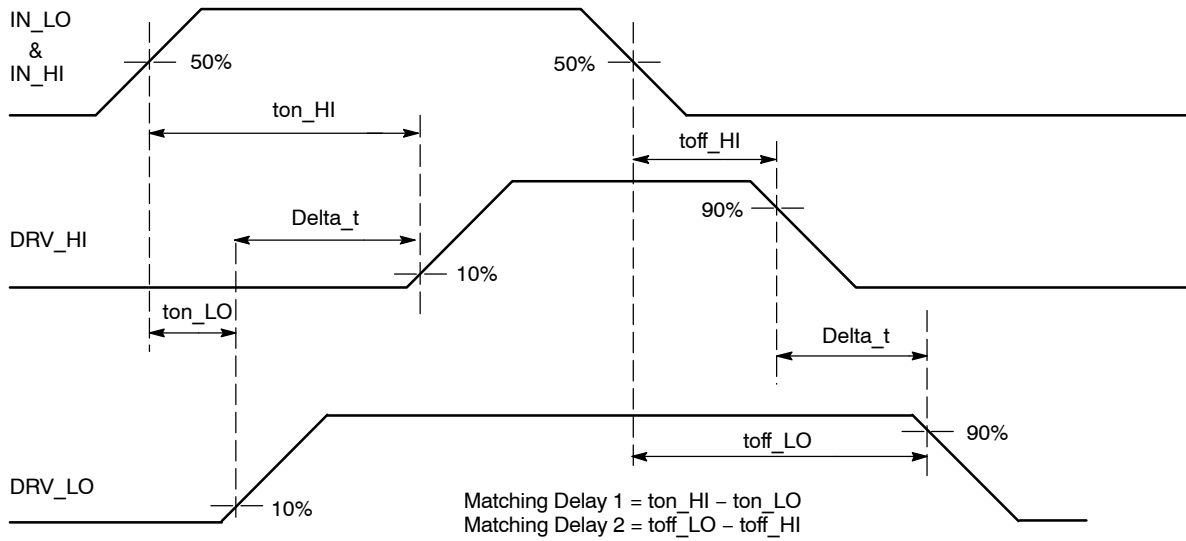

Figure 8. Matching Propagation Delay (A Version)

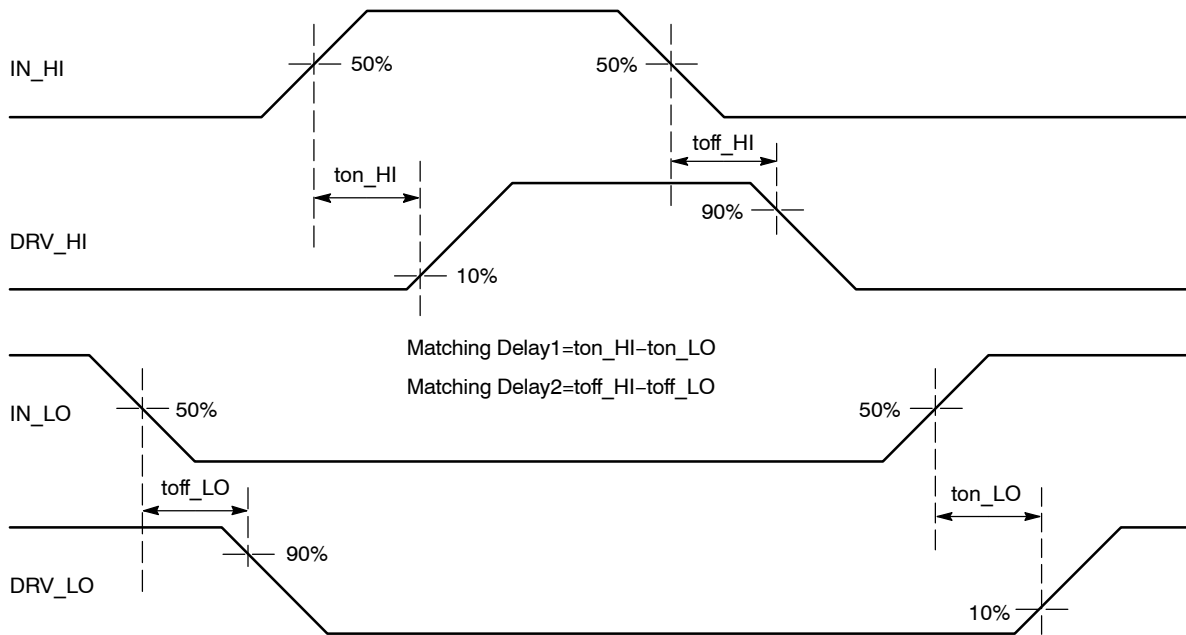

Figure 9. Matching Propagation Delay (B Version)

NCV5106A, NCV5106B

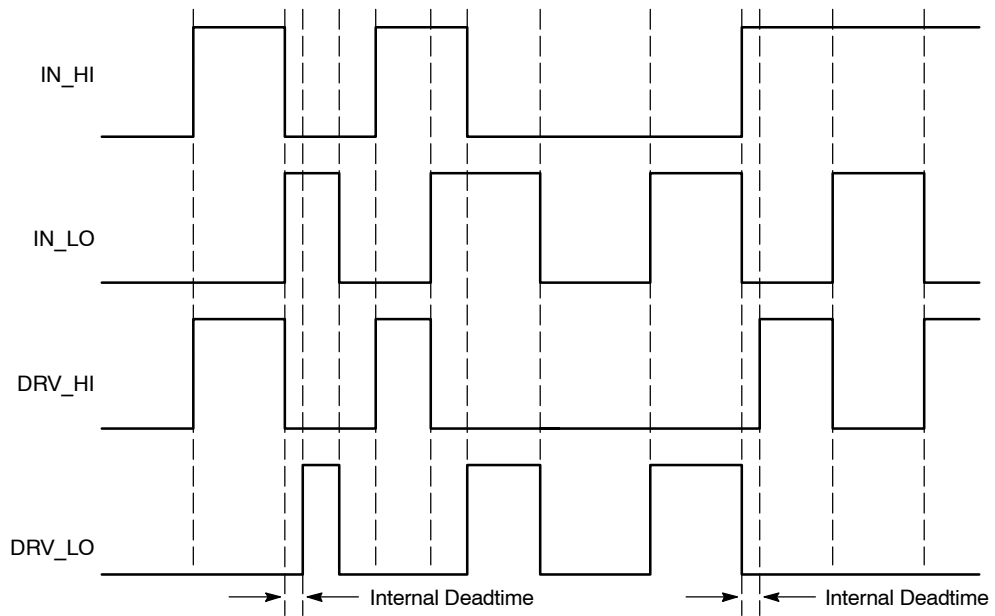

Figure 10. Input/Output Cross Conduction Output Protection Timing Diagram (B Version)

CHARACTERIZATION CURVES

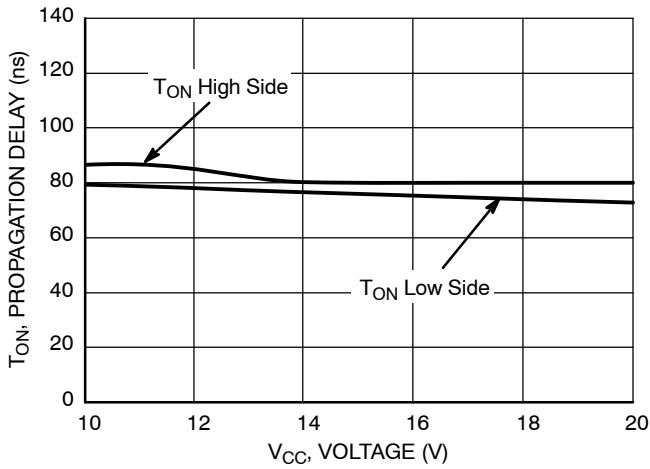

Figure 11. Turn ON Propagation Delay vs. Supply Voltage ($V_{CC} = V_{BOOT}$)

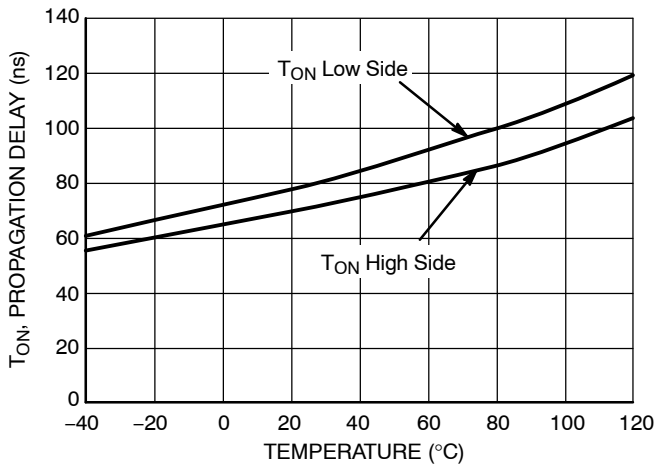

Figure 12. Turn ON Propagation Delay vs. Temperature

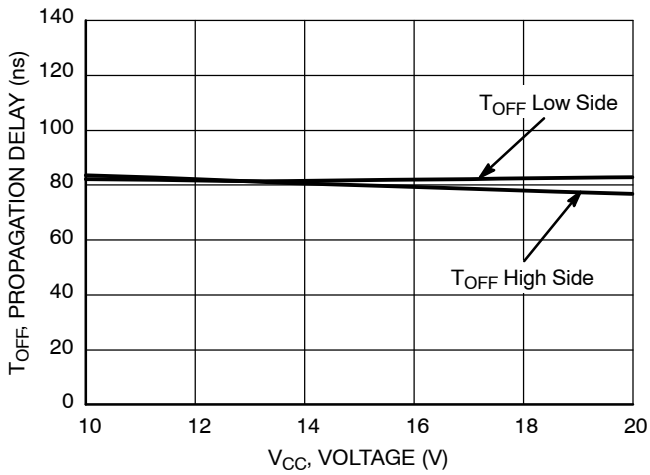

Figure 13. Turn OFF Propagation Delay vs. Supply Voltage ($V_{CC} = V_{BOOT}$)

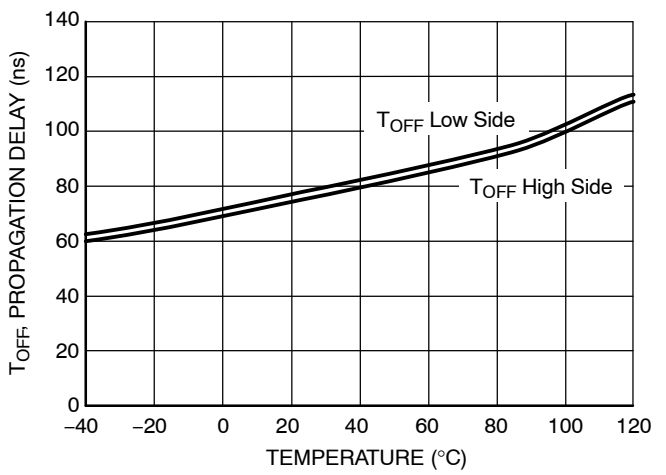

Figure 14. Turn OFF Propagation Delay vs. Temperature

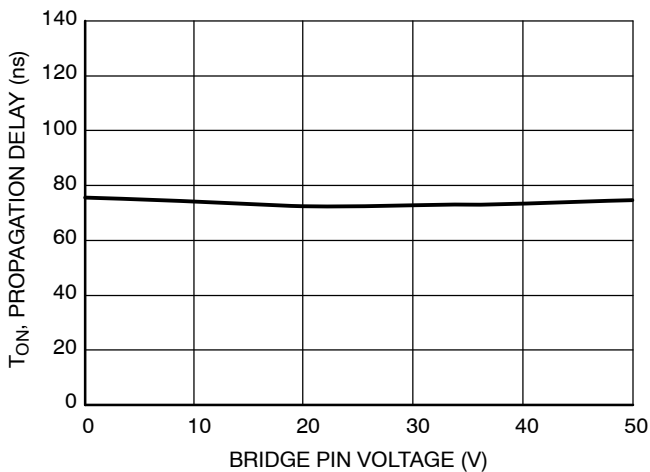

Figure 15. High Side Turn ON Propagation Delay vs. V_{BRIDGE} Voltage

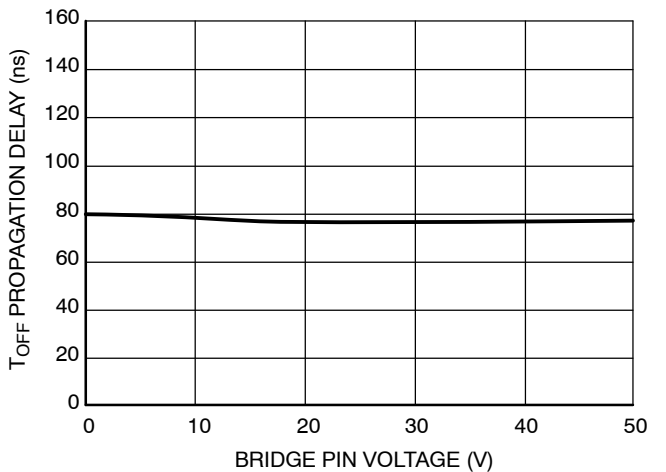

Figure 16. High Side Turn OFF Propagation Delay vs. V_{BRIDGE} Voltage

CHARACTERIZATION CURVES

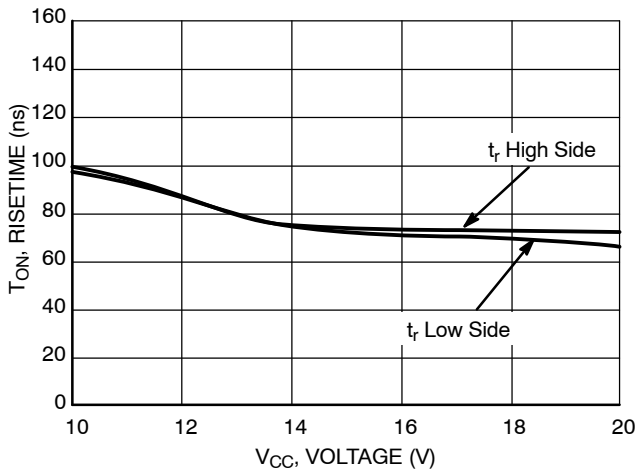

Figure 17. Turn ON Risetime vs. Supply Voltage ($V_{CC} = V_{BOOT}$)

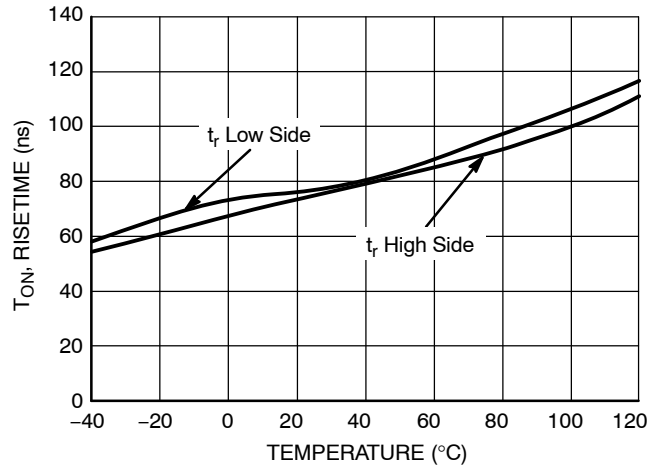

Figure 18. Turn ON Risetime vs. Temperature

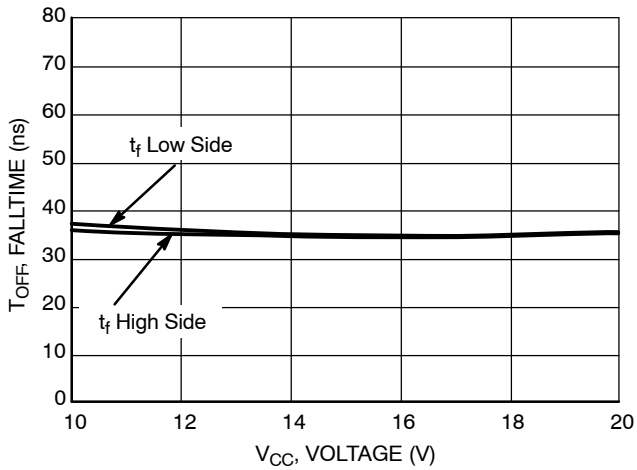

Figure 19. Turn OFF Falltime vs. Supply Voltage ($V_{CC} = V_{BOOT}$)

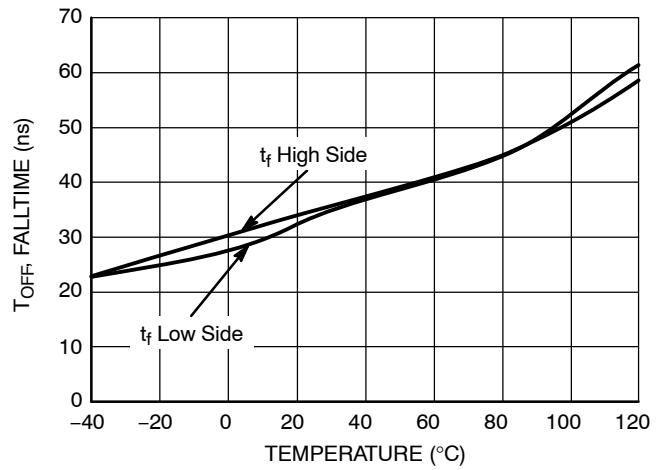

Figure 20. Turn OFF Falltime vs. Temperature

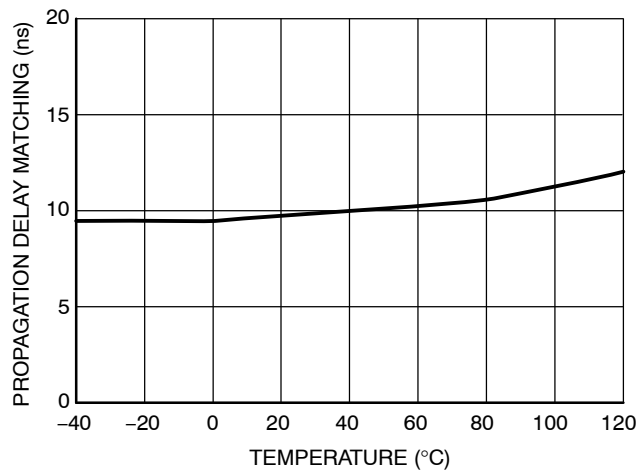

Figure 21. Propagation Delay Matching Between High Side and Low Side Driver vs. Temperature

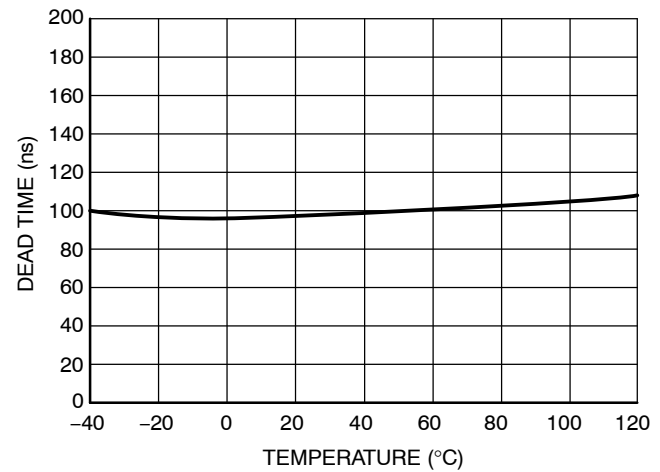

Figure 22. Dead Time vs. Temperature

CHARACTERIZATION CURVES

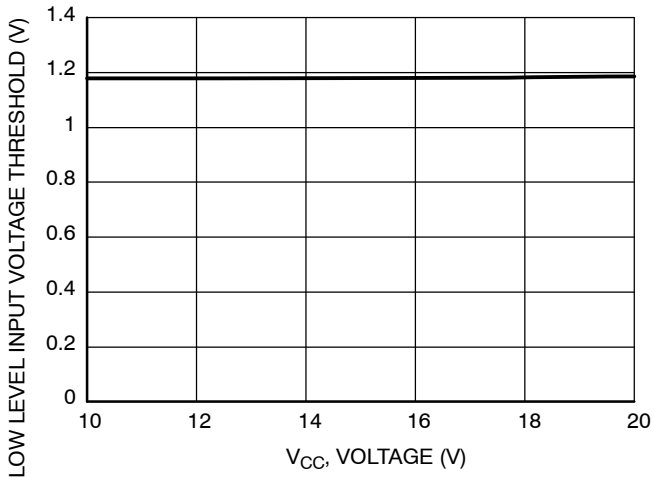

Figure 23. Low Level Input Voltage Threshold vs. Supply Voltage ($V_{CC} = V_{BOOT}$)

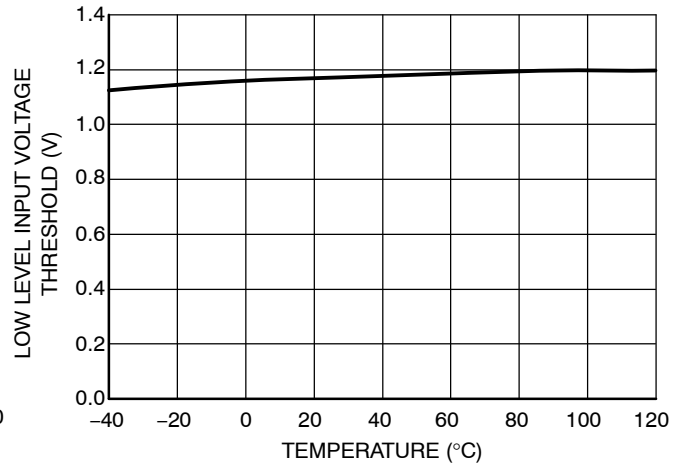

Figure 24. Low Level Input Voltage Threshold vs. Temperature

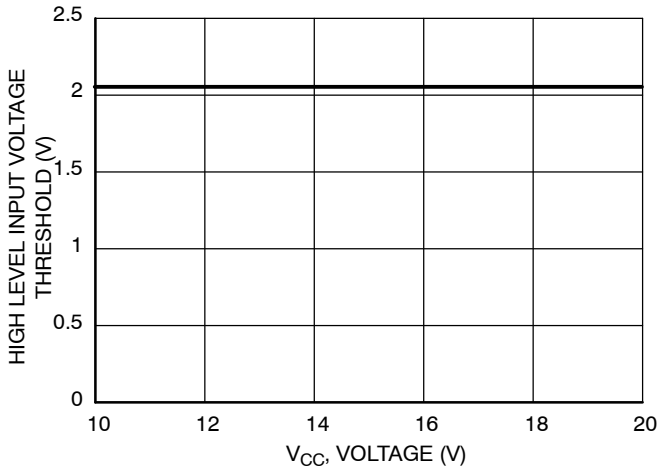

Figure 25. High Level Input Voltage Threshold vs. Supply Voltage ($V_{CC} = V_{BOOT}$)

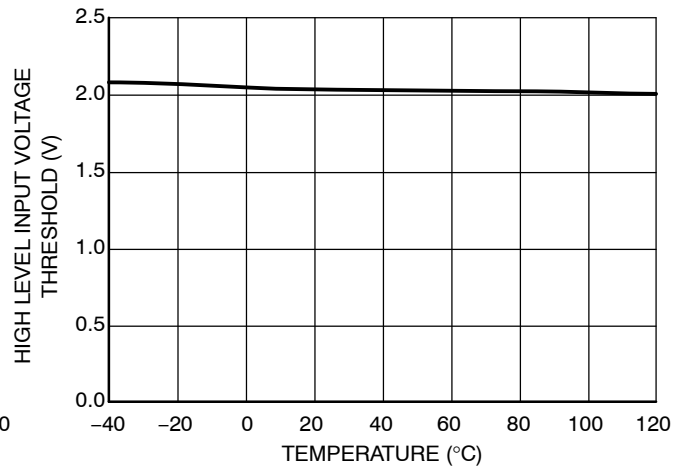

Figure 26. High Level Input Voltage Threshold vs. Temperature

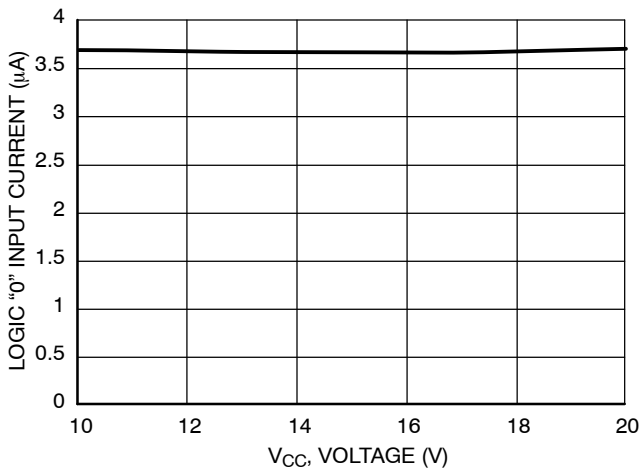

Figure 27. Logic "0" Input Current vs. Supply Voltage ($V_{CC} = V_{BOOT}$)

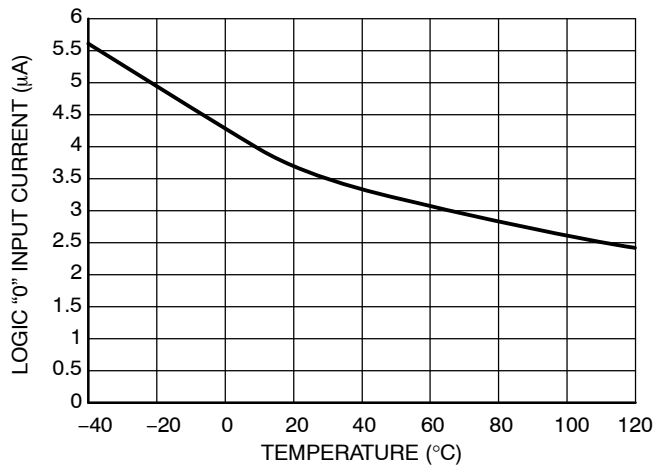

Figure 28. Logic "0" Input Current vs. Temperature

CHARACTERIZATION CURVES

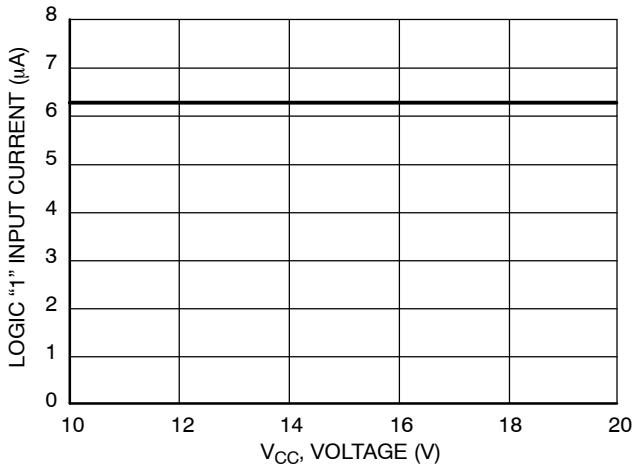

Figure 29. Logic "1" Input Current vs. Supply Voltage (V_{CC} = V_{BOOT})

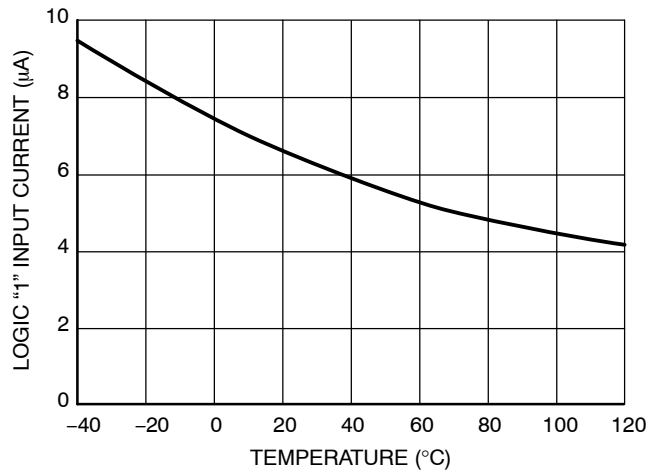

Figure 30. Logic "1" Input Current vs. Temperature

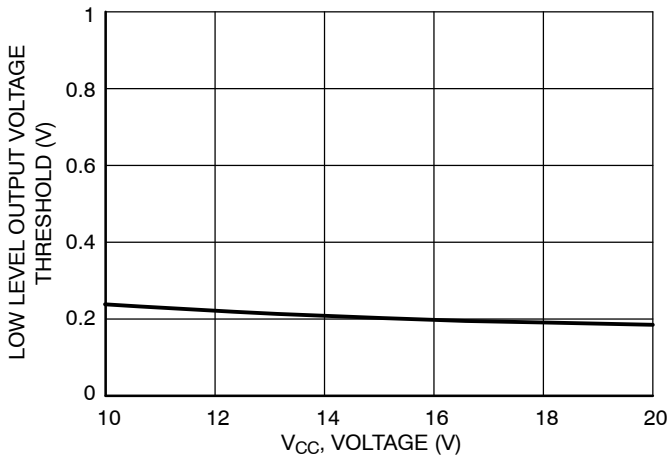

Figure 31. Low Level Output Voltage vs. Supply Voltage (V_{CC} = V_{BOOT})

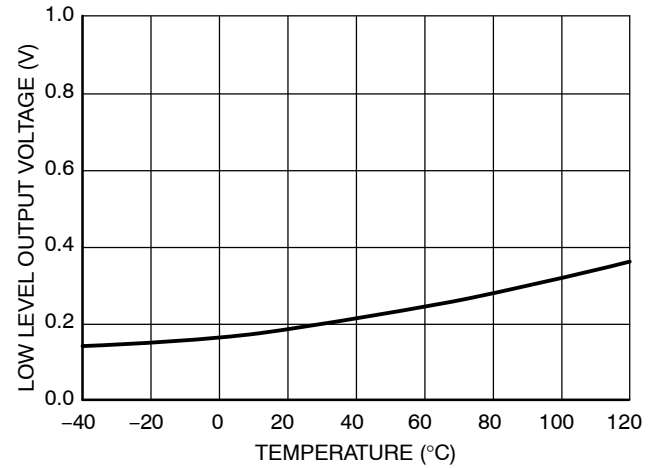

Figure 32. Low Level Output Voltage vs. Temperature

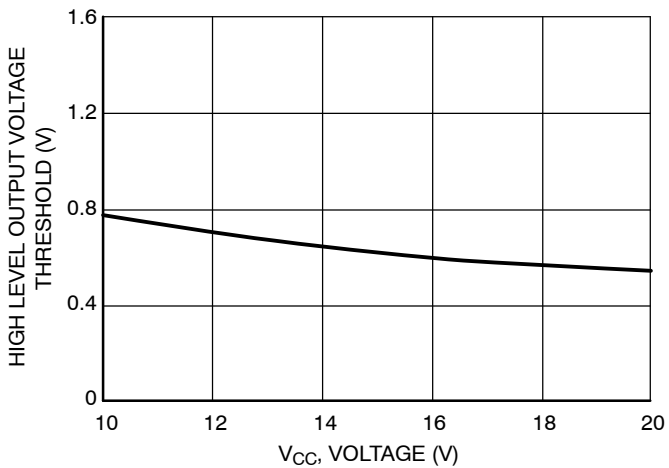

Figure 33. High Level Output Voltage vs. Supply Voltage (V_{CC} = V_{BOOT})

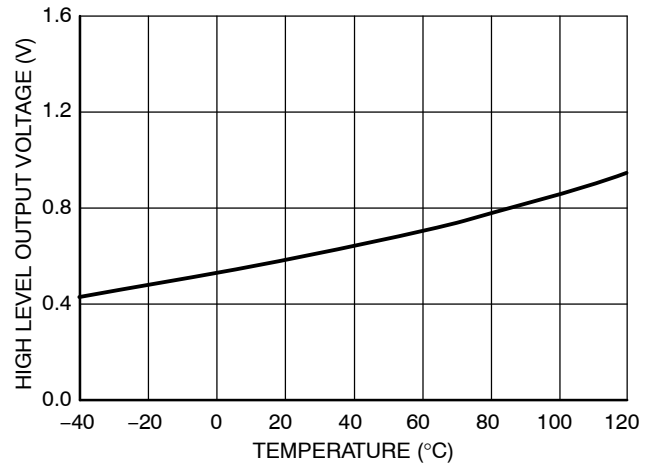

Figure 34. High Level Output Voltage vs. Temperature

CHARACTERIZATION CURVES

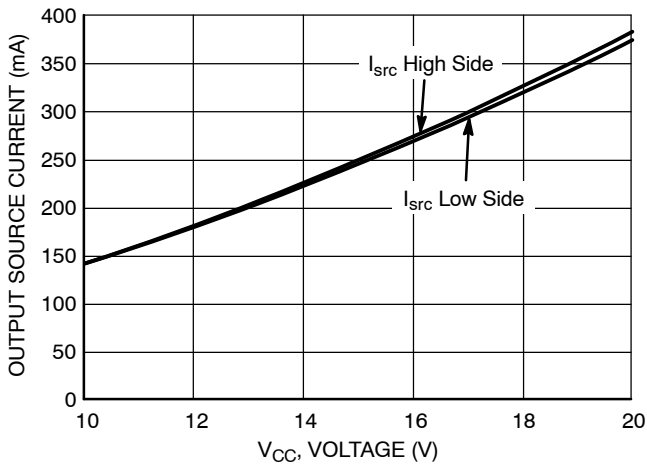

Figure 35. Output Source Current vs. Supply Voltage (V_{CC} = V_{BOOT})

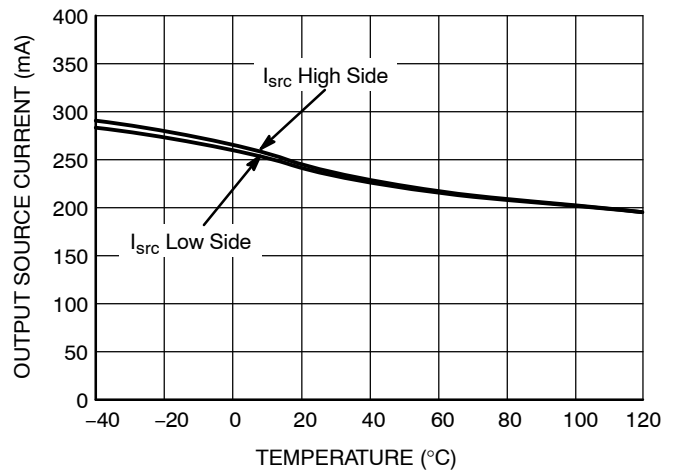

Figure 36. Output Source Current vs. Temperature

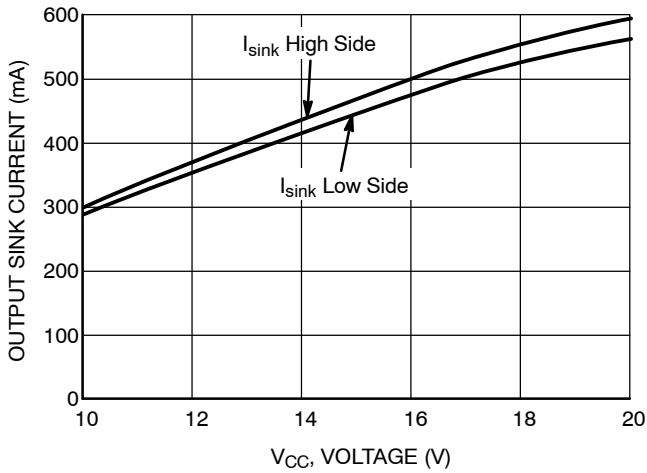

Figure 37. Output Sink Current vs. Supply Voltage (V_{CC} = V_{BOOT})

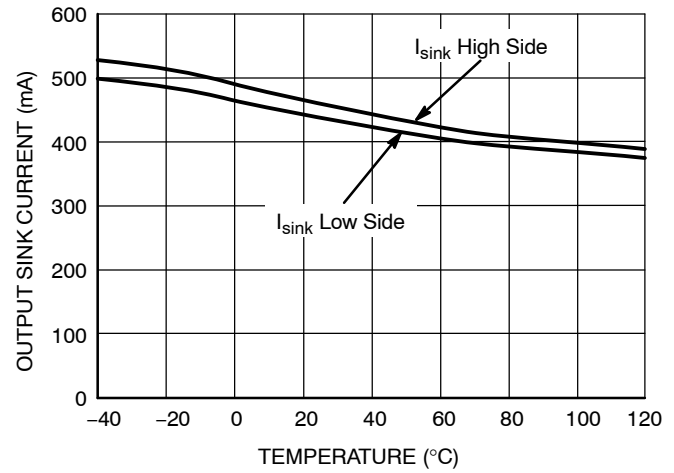

Figure 38. Output Sink Current vs. Temperature

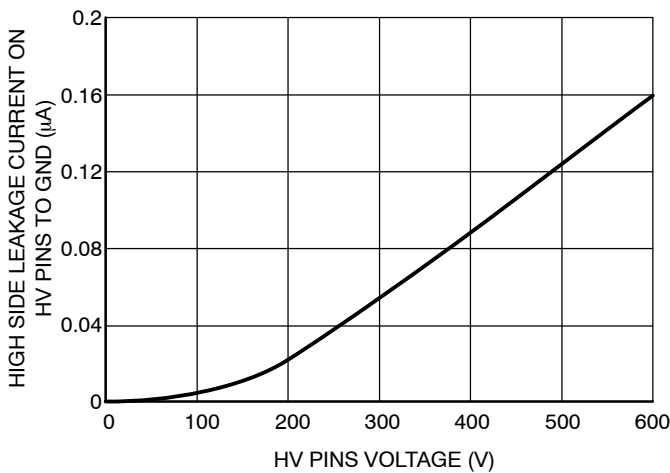

Figure 39. Leakage Current on High Voltage Pins (600 V) to Ground vs. V_{BRIDGE} Voltage (V_{BRIDGE} = V_{BOOT} = V_{DRV HI})

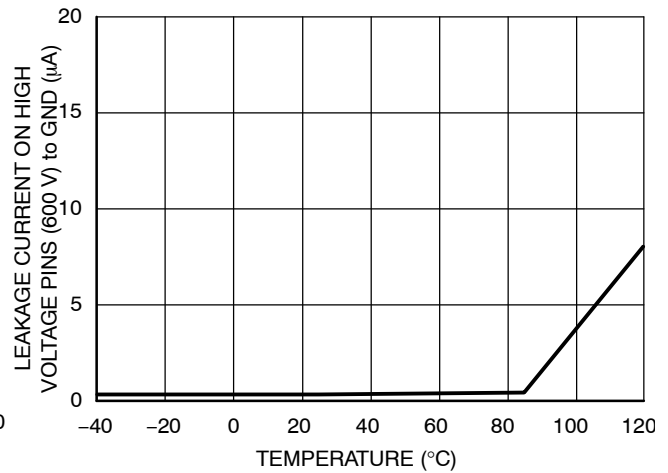

Figure 40. Leakage Current on High Voltage Pins (600 V) to Ground vs. Temperature (V_{BRIDGE} = V_{BOOT} = V_{DRV HI} = 600 V)

NCV5106A, NCV5106B

CHARACTERIZATION CURVES

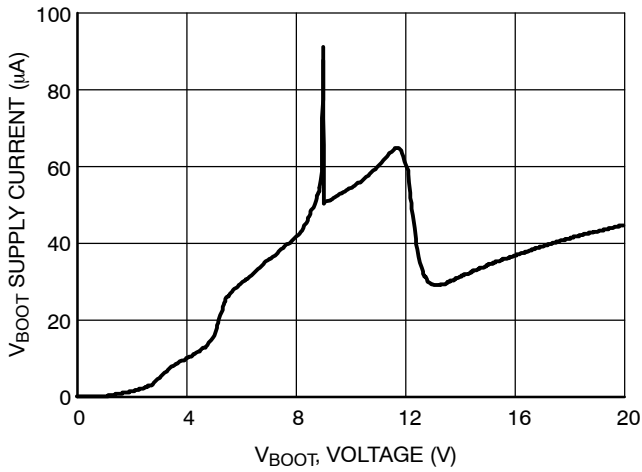

Figure 41. V_{BOOT} Supply Current vs. Bootstrap Supply Voltage

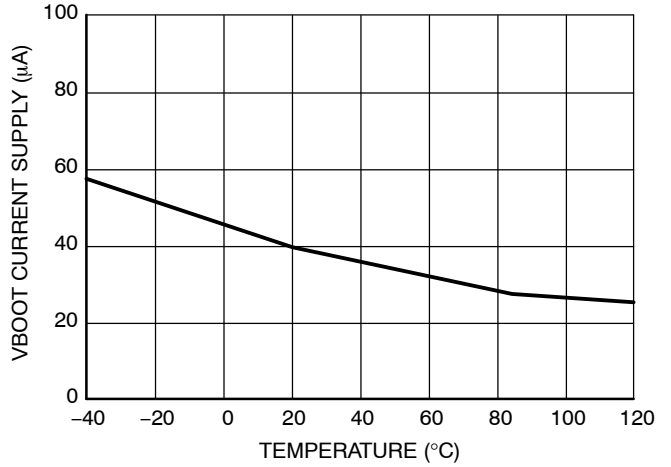

Figure 42. V_{BOOT} Supply Current vs. Temperature

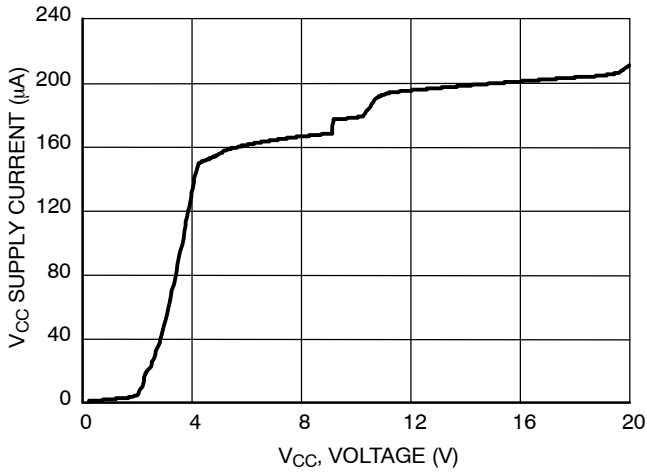

Figure 43. V_{CC} Supply Current vs. V_{CC} Supply Voltage

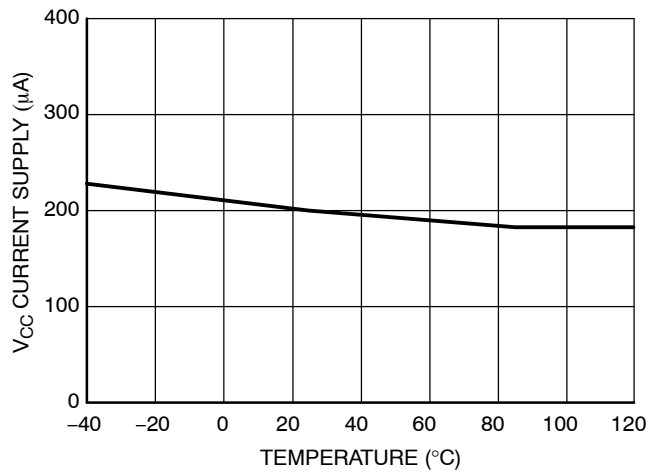

Figure 44. V_{CC} Supply Current vs. Temperature

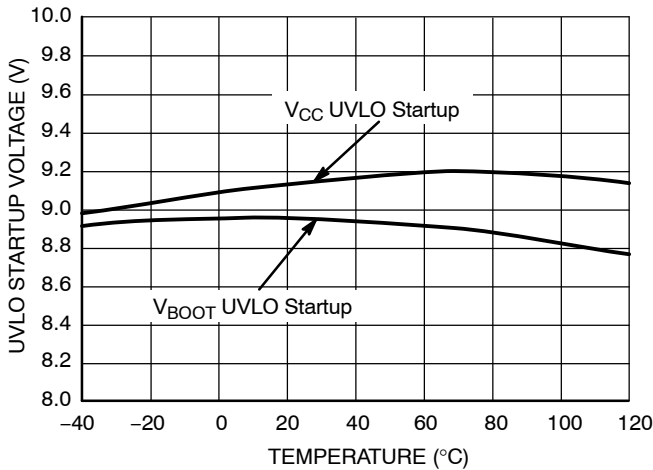

Figure 45. UVLO Startup Voltage vs. Temperature

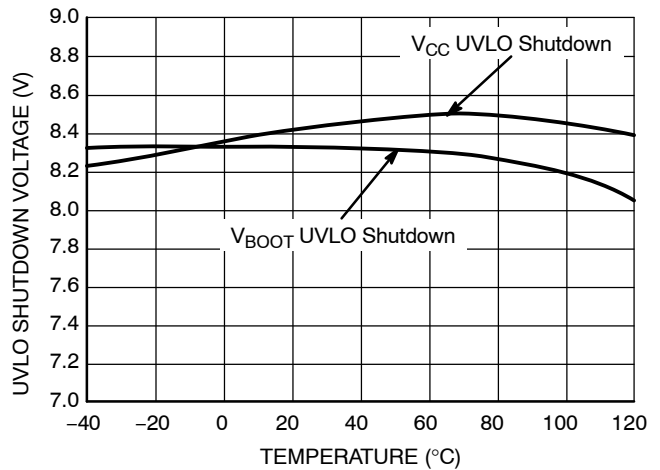

Figure 46. UVLO Shutdown Voltage vs. Temperature

CHARACTERIZATION CURVES

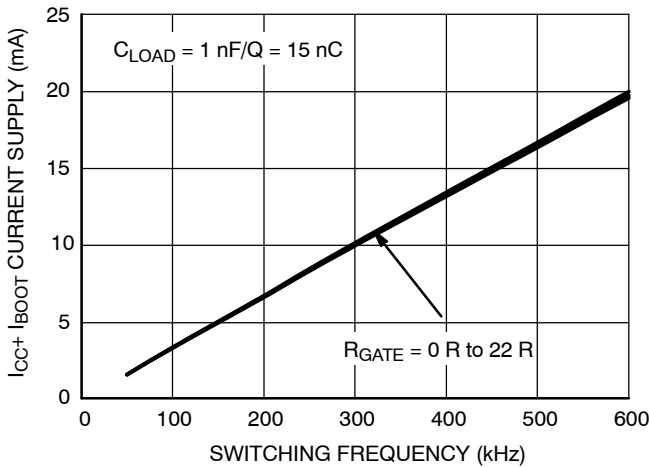

Figure 47. I_{CC1} Consumption vs. Switching Frequency with 15 nC Load on Each Driver @ $V_{CC} = 15 V$

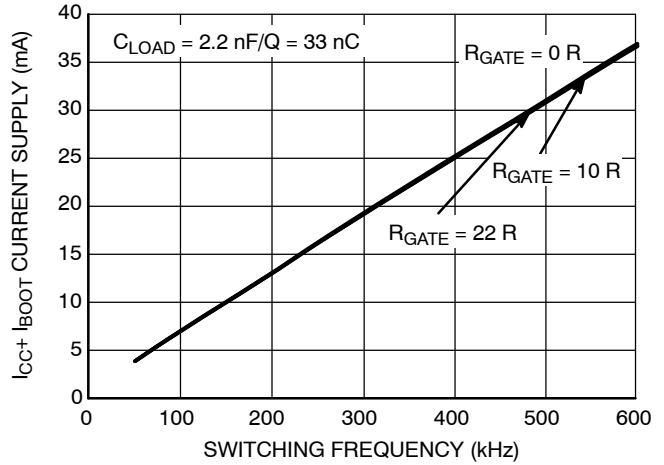

Figure 48. I_{CC1} Consumption vs. Switching Frequency with 33 nC Load on Each Driver @ $V_{CC} = 15 V$

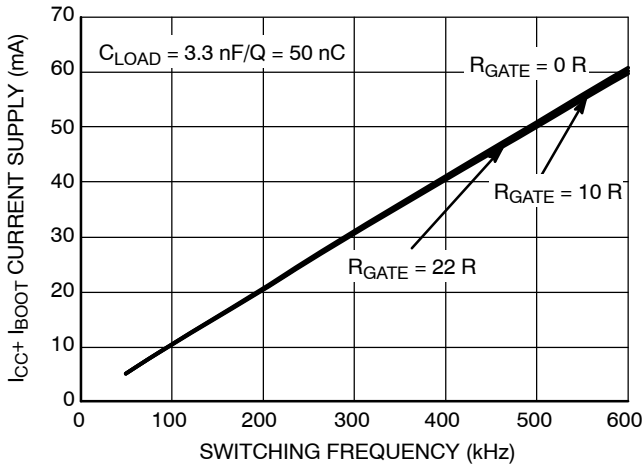

Figure 49. I_{CC1} Consumption vs. Switching Frequency with 50 nC Load on Each Driver @ $V_{CC} = 15 V$

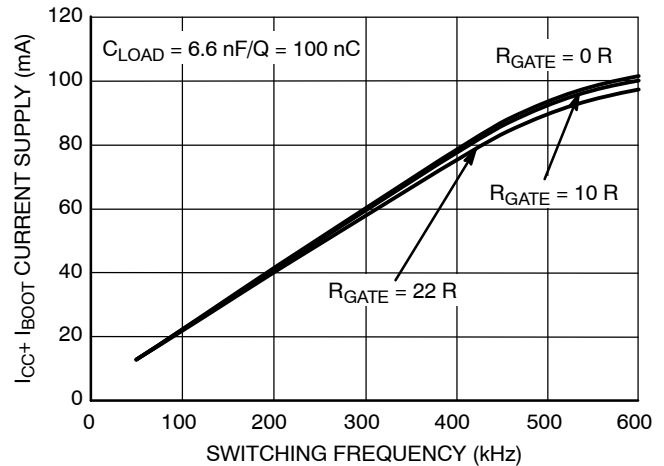

Figure 50. I_{CC1} Consumption vs. Switching Frequency with 100 nC Load on Each Driver @ $V_{CC} = 15 V$

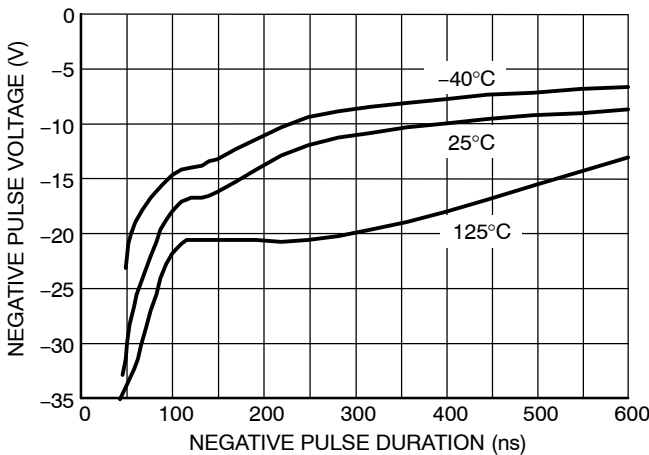

Figure 51. NCV5106A, Negative Voltage Safe Operating Area on the Bridge Pin

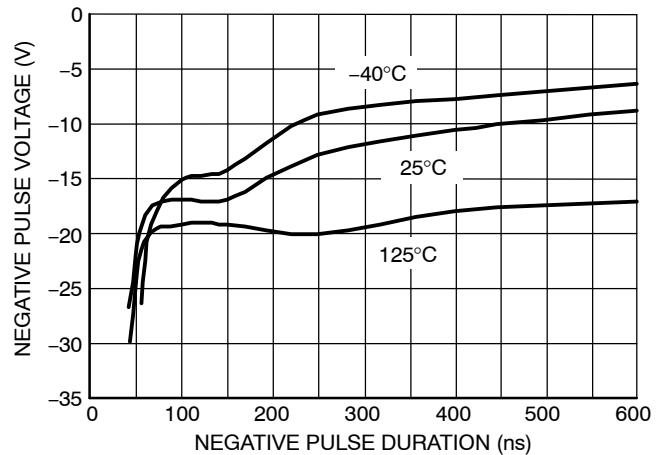

Figure 52. NCV5106B, Negative Voltage Safe Operating Area on the Bridge Pin

APPLICATION INFORMATION

Negative Voltage Safe Operating Area

When the driver is used in a half bridge configuration, it is possible to see negative voltage appearing on the bridge pin (pin 6) during the power MOSFETs transitions. When the high-side MOSFET is switched off, the body diode of the low-side MOSFET starts to conduct. The negative voltage applied to the bridge pin thus corresponds to the forward voltage of the body diode. However, as pcb copper tracks and wire bonding introduce stray elements (inductance and capacitor), the maximum negative voltage of the bridge pin will combine the forward voltage and the oscillations created by the parasitic elements. As any CMOS device, the deep negative voltage of a selected pin can inject carriers into the substrate, leading to an erratic behavior of the concerned component. ON Semiconductor provides characterization data of its half-bridge driver to show the maximum negative voltage the driver can safely operate with. To prevent the negative injection, it is the designer duty to verify that the amount of negative voltage pertinent to his/her application does not exceed the characterization curve we provide, including some safety margin.

In order to estimate the maximum negative voltage accepted by the driver, this parameter has been characterized over full the temperature range of the component. A test fixture has been developed in which we purposely negatively bias the bridge pin during the freewheel period of a buck converter. When the upper gate voltage shows signs of an erratic behavior, we consider the limit has been reached.

Figure 51 (or 52), illustrates the negative voltage safe operating area. Its interpretation is as follows: assume a negative 10 V pulse featuring a 100 ns width is applied on the bridge pin, the driver will work correctly over the whole die temperature range. Should the pulse swing to -20 V, keeping the same width of 100 ns, the driver will not work properly or will be damaged for temperatures below 125°C.

Summary:

- If the negative pulse characteristic (negative voltage level & pulse width) is above the curves the driver runs in safe operating area.
- If the negative pulse characteristic (negative voltage level & pulse width) is below one or all curves the driver will NOT run in safe operating area.

Note, each curve of the Figure 51 (or 52) represents the negative voltage and width level where the driver starts to fail at the corresponding die temperature.

If in the application the bridge pin is too close of the safe operating limit, it is possible to limit the negative voltage to the bridge pin by inserting one resistor and one diode as follows:

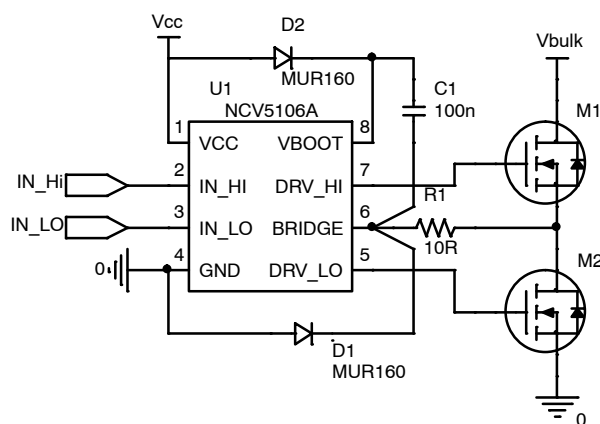

Figure 53. R1 and D1 Improves the Robustness of the Driver

R1 and D1 should be placed as close as possible of the driver. D1 should be connected directly between the bridge pin (pin 6) and the ground pin (pin 4). By this way the negative voltage applied to the bridge pin will be limited by D1 and R1 and will prevent any wrong behavior.

ORDERING INFORMATION

Device	Package	Shipping†
NCV5106ADR2G	SOIC-8 (Pb-Free)	2500 / Tape & Reel
NCV5106BDR2G (On demand only, not released in production)	SOIC-8 (Pb-Free)	2500 / Tape & Reel

†For information on tape and reel specifications, including part orientation and tape sizes, please refer to our Tape and Reel Packaging Specifications Brochure, BRD8011/D.

MECHANICAL CASE OUTLINE PACKAGE DIMENSIONS



SCALE 1:1

SOIC-8 NB
CASE 751-07
ISSUE AK

DATE 16 FEB 2011



- NOTES:
1. DIMENSIONING AND TOLERANCING PER ANSI Y14.5M, 1982.
 2. CONTROLLING DIMENSION: MILLIMETER.
 3. DIMENSION A AND B DO NOT INCLUDE MOLD PROTRUSION.
 4. MAXIMUM MOLD PROTRUSION 0.15 (0.006) PER SIDE.
 5. DIMENSION D DOES NOT INCLUDE DAMBAR PROTRUSION. ALLOWABLE DAMBAR PROTRUSION SHALL BE 0.127 (0.005) TOTAL IN EXCESS OF THE D DIMENSION AT MAXIMUM MATERIAL CONDITION.
 6. 751-01 THRU 751-06 ARE OBSOLETE. NEW STANDARD IS 751-07.

DIM	MILLIMETERS		INCHES	
	MIN	MAX	MIN	MAX
A	4.80	5.00	0.189	0.197
B	3.80	4.00	0.150	0.157
C	1.35	1.75	0.053	0.069
D	0.33	0.51	0.013	0.020
G	1.27 BSC		0.050 BSC	
H	0.10	0.25	0.004	0.010
J	0.19	0.25	0.007	0.010
K	0.40	1.27	0.016	0.050
M	0°	8°	0°	8°
N	0.25	0.50	0.010	0.020
S	5.80	6.20	0.228	0.244

SOLDERING FOOTPRINT*



*For additional information on our Pb-Free strategy and soldering details, please download the ON Semiconductor Soldering and Mounting Techniques Reference Manual, SOLDERRM/D.

GENERIC MARKING DIAGRAM*



XXXXXX = Specific Device Code
A = Assembly Location
L = Wafer Lot
Y = Year
W = Work Week
▪ = Pb-Free Package

XXXXXX = Specific Device Code
A = Assembly Location
Y = Year
WW = Work Week
▪ = Pb-Free Package

*This information is generic. Please refer to device data sheet for actual part marking. Pb-Free indicator, "G" or microdot "▪", may or may not be present. Some products may not follow the Generic Marking.

STYLES ON PAGE 2

DOCUMENT NUMBER:	98ASB42564B	Electronic versions are uncontrolled except when accessed directly from the Document Repository. Printed versions are uncontrolled except when stamped "CONTROLLED COPY" in red.
DESCRIPTION:	SOIC-8 NB	PAGE 1 OF 2

onsemi and ONsemi are trademarks of Semiconductor Components Industries, LLC dba onsemi or its subsidiaries in the United States and/or other countries. onsemi reserves the right to make changes without further notice to any products herein. onsemi makes no warranty, representation or guarantee regarding the suitability of its products for any particular purpose, nor does onsemi assume any liability arising out of the application or use of any product or circuit, and specifically disclaims any and all liability, including without limitation special, consequential or incidental damages. onsemi does not convey any license under its patent rights nor the rights of others.

SOIC-8 NB
CASE 751-07
ISSUE AK

DATE 16 FEB 2011

- | | | | |
|--|---|---|---|
| <p>STYLE 1:
 PIN 1. EMITTER
 2. COLLECTOR
 3. COLLECTOR
 4. EMITTER
 5. EMITTER
 6. BASE
 7. BASE
 8. EMITTER</p> | <p>STYLE 2:
 PIN 1. COLLECTOR, DIE, #1
 2. COLLECTOR, #1
 3. COLLECTOR, #2
 4. COLLECTOR, #2
 5. BASE, #2
 6. EMITTER, #2
 7. BASE, #1
 8. EMITTER, #1</p> | <p>STYLE 3:
 PIN 1. DRAIN, DIE #1
 2. DRAIN, #1
 3. DRAIN, #2
 4. DRAIN, #2
 5. GATE, #2
 6. SOURCE, #2
 7. GATE, #1
 8. SOURCE, #1</p> | <p>STYLE 4:
 PIN 1. ANODE
 2. ANODE
 3. ANODE
 4. ANODE
 5. ANODE
 6. ANODE
 7. ANODE
 8. COMMON CATHODE</p> |
| <p>STYLE 5:
 PIN 1. DRAIN
 2. DRAIN
 3. DRAIN
 4. DRAIN
 5. GATE
 6. GATE
 7. SOURCE
 8. SOURCE</p> | <p>STYLE 6:
 PIN 1. SOURCE
 2. DRAIN
 3. DRAIN
 4. SOURCE
 5. SOURCE
 6. GATE
 7. GATE
 8. SOURCE</p> | <p>STYLE 7:
 PIN 1. INPUT
 2. EXTERNAL BYPASS
 3. THIRD STAGE SOURCE
 4. GROUND
 5. DRAIN
 6. GATE 3
 7. SECOND STAGE Vd
 8. FIRST STAGE Vd</p> | <p>STYLE 8:
 PIN 1. COLLECTOR, DIE #1
 2. BASE, #1
 3. BASE, #2
 4. COLLECTOR, #2
 5. COLLECTOR, #2
 6. EMITTER, #2
 7. EMITTER, #1
 8. COLLECTOR, #1</p> |
| <p>STYLE 9:
 PIN 1. EMITTER, COMMON
 2. COLLECTOR, DIE #1
 3. COLLECTOR, DIE #2
 4. EMITTER, COMMON
 5. EMITTER, COMMON
 6. BASE, DIE #2
 7. BASE, DIE #1
 8. EMITTER, COMMON</p> | <p>STYLE 10:
 PIN 1. GROUND
 2. BIAS 1
 3. OUTPUT
 4. GROUND
 5. GROUND
 6. BIAS 2
 7. INPUT
 8. GROUND</p> | <p>STYLE 11:
 PIN 1. SOURCE 1
 2. GATE 1
 3. SOURCE 2
 4. GATE 2
 5. DRAIN 2
 6. DRAIN 2
 7. DRAIN 1
 8. DRAIN 1</p> | <p>STYLE 12:
 PIN 1. SOURCE
 2. SOURCE
 3. SOURCE
 4. GATE
 5. DRAIN
 6. DRAIN
 7. DRAIN
 8. DRAIN</p> |
| <p>STYLE 13:
 PIN 1. N.C.
 2. SOURCE
 3. SOURCE
 4. GATE
 5. DRAIN
 6. DRAIN
 7. DRAIN
 8. DRAIN</p> | <p>STYLE 14:
 PIN 1. N-SOURCE
 2. N-GATE
 3. P-SOURCE
 4. P-GATE
 5. P-DRAIN
 6. P-DRAIN
 7. N-DRAIN
 8. N-DRAIN</p> | <p>STYLE 15:
 PIN 1. ANODE 1
 2. ANODE 1
 3. ANODE 1
 4. ANODE 1
 5. CATHODE, COMMON
 6. CATHODE, COMMON
 7. CATHODE, COMMON
 8. CATHODE, COMMON</p> | <p>STYLE 16:
 PIN 1. EMITTER, DIE #1
 2. BASE, DIE #1
 3. EMITTER, DIE #2
 4. BASE, DIE #2
 5. COLLECTOR, DIE #2
 6. COLLECTOR, DIE #2
 7. COLLECTOR, DIE #1
 8. COLLECTOR, DIE #1</p> |
| <p>STYLE 17:
 PIN 1. VCC
 2. V2OUT
 3. V1OUT
 4. TXE
 5. RXE
 6. VEE
 7. GND
 8. ACC</p> | <p>STYLE 18:
 PIN 1. ANODE
 2. ANODE
 3. SOURCE
 4. GATE
 5. DRAIN
 6. DRAIN
 7. CATHODE
 8. CATHODE</p> | <p>STYLE 19:
 PIN 1. SOURCE 1
 2. GATE 1
 3. SOURCE 2
 4. GATE 2
 5. DRAIN 2
 6. MIRROR 2
 7. DRAIN 1
 8. MIRROR 1</p> | <p>STYLE 20:
 PIN 1. SOURCE (N)
 2. GATE (N)
 3. SOURCE (P)
 4. GATE (P)
 5. DRAIN
 6. DRAIN
 7. DRAIN
 8. DRAIN</p> |
| <p>STYLE 21:
 PIN 1. CATHODE 1
 2. CATHODE 2
 3. CATHODE 3
 4. CATHODE 4
 5. CATHODE 5
 6. COMMON ANODE
 7. COMMON ANODE
 8. CATHODE 6</p> | <p>STYLE 22:
 PIN 1. I/O LINE 1
 2. COMMON CATHODE/VCC
 3. COMMON CATHODE/VCC
 4. I/O LINE 3
 5. COMMON ANODE/GND
 6. I/O LINE 4
 7. I/O LINE 5
 8. COMMON ANODE/GND</p> | <p>STYLE 23:
 PIN 1. LINE 1 IN
 2. COMMON ANODE/GND
 3. COMMON ANODE/GND
 4. LINE 2 IN
 5. LINE 2 OUT
 6. COMMON ANODE/GND
 7. COMMON ANODE/GND
 8. LINE 1 OUT</p> | <p>STYLE 24:
 PIN 1. BASE
 2. EMITTER
 3. COLLECTOR/ANODE
 4. COLLECTOR/ANODE
 5. CATHODE
 6. CATHODE
 7. COLLECTOR/ANODE
 8. COLLECTOR/ANODE</p> |
| <p>STYLE 25:
 PIN 1. VIN
 2. N/C
 3. REXT
 4. GND
 5. IOUT
 6. IOUT
 7. IOUT
 8. IOUT</p> | <p>STYLE 26:
 PIN 1. GND
 2. dv/dt
 3. ENABLE
 4. ILIMIT
 5. SOURCE
 6. SOURCE
 7. SOURCE
 8. VCC</p> | <p>STYLE 27:
 PIN 1. ILIMIT
 2. OVLO
 3. UVLO
 4. INPUT+
 5. SOURCE
 6. SOURCE
 7. SOURCE
 8. DRAIN</p> | <p>STYLE 28:
 PIN 1. SW_TO_GND
 2. DASIC OFF
 3. DASIC_SW_DET
 4. GND
 5. V_MON
 6. VBULK
 7. VBULK
 8. VIN</p> |
| <p>STYLE 29:
 PIN 1. BASE, DIE #1
 2. EMITTER, #1
 3. BASE, #2
 4. EMITTER, #2
 5. COLLECTOR, #2
 6. COLLECTOR, #2
 7. COLLECTOR, #1
 8. COLLECTOR, #1</p> | <p>STYLE 30:
 PIN 1. DRAIN 1
 2. DRAIN 1
 3. GATE 2
 4. SOURCE 2
 5. SOURCE 1/DRAIN 2
 6. SOURCE 1/DRAIN 2
 7. SOURCE 1/DRAIN 2
 8. GATE 1</p> | | |

DOCUMENT NUMBER:	98ASB42564B	Electronic versions are uncontrolled except when accessed directly from the Document Repository. Printed versions are uncontrolled except when stamped "CONTROLLED COPY" in red.
DESCRIPTION:	SOIC-8 NB	PAGE 2 OF 2

onsemi and **ONSEMI** are trademarks of Semiconductor Components Industries, LLC dba **onsemi** or its subsidiaries in the United States and/or other countries. **onsemi** reserves the right to make changes without further notice to any products herein. **onsemi** makes no warranty, representation or guarantee regarding the suitability of its products for any particular purpose, nor does **onsemi** assume any liability arising out of the application or use of any product or circuit, and specifically disclaims any and all liability, including without limitation special, consequential or incidental damages. **onsemi** does not convey any license under its patent rights nor the rights of others.

onsemi, **Onsemi**, and other names, marks, and brands are registered and/or common law trademarks of Semiconductor Components Industries, LLC dba "**onsemi**" or its affiliates and/or subsidiaries in the United States and/or other countries. **onsemi** owns the rights to a number of patents, trademarks, copyrights, trade secrets, and other intellectual property. A listing of **onsemi**'s product/patent coverage may be accessed at www.onsemi.com/site/pdf/Patent-Marking.pdf. **onsemi** reserves the right to make changes at any time to any products or information herein, without notice. The information herein is provided "as-is" and **onsemi** makes no warranty, representation or guarantee regarding the accuracy of the information, product features, availability, functionality, or suitability of its products for any particular purpose, nor does **onsemi** assume any liability arising out of the application or use of any product or circuit, and specifically disclaims any and all liability, including without limitation special, consequential or incidental damages. Buyer is responsible for its products and applications using **onsemi** products, including compliance with all laws, regulations and safety requirements or standards, regardless of any support or applications information provided by **onsemi**. "Typical" parameters which may be provided in **onsemi** data sheets and/or specifications can and do vary in different applications and actual performance may vary over time. All operating parameters, including "Typicals" must be validated for each customer application by customer's technical experts. **onsemi** does not convey any license under any of its intellectual property rights nor the rights of others. **onsemi** products are not designed, intended, or authorized for use as a critical component in life support systems or any FDA Class 3 medical devices or medical devices with a same or similar classification in a foreign jurisdiction or any devices intended for implantation in the human body. Should Buyer purchase or use **onsemi** products for any such unintended or unauthorized application, Buyer shall indemnify and hold **onsemi** and its officers, employees, subsidiaries, affiliates, and distributors harmless against all claims, costs, damages, and expenses, and reasonable attorney fees arising out of, directly or indirectly, any claim of personal injury or death associated with such unintended or unauthorized use, even if such claim alleges that **onsemi** was negligent regarding the design or manufacture of the part. **onsemi** is an Equal Opportunity/Affirmative Action Employer. This literature is subject to all applicable copyright laws and is not for resale in any manner.

PUBLICATION ORDERING INFORMATION

LITERATURE FULFILLMENT:

Email Requests to: orderlit@onsemi.com

onsemi Website: www.onsemi.com

TECHNICAL SUPPORT

North American Technical Support:
Voice Mail: 1 800-282-9855 Toll Free USA/Canada
Phone: 011 421 33 790 2910

Europe, Middle East and Africa Technical Support:

Phone: 00421 33 790 2910

For additional information, please contact your local Sales Representative