

## 1. Electrical Characteristics

Please refer to Appendix A (Page 9~13).

- 1) Operating and storage temperature range (individual chip without packing): -55°C ~ +125°C.
- 2) Storage temperature range (packaging conditions): -10°C~+40°C RH 70% (Max.).

## 2. Shape and Dimensions

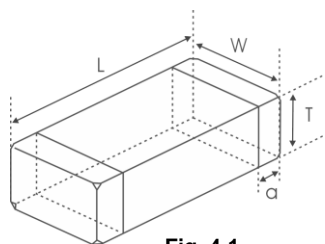

Fig. 4-1

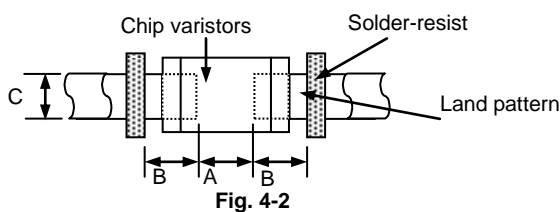
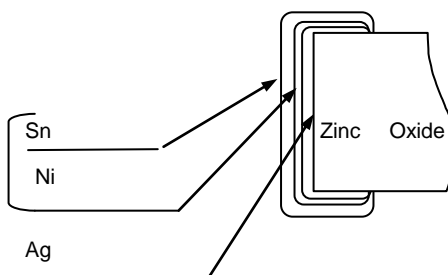
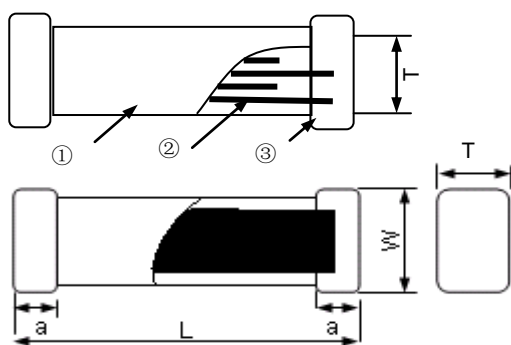

Fig. 4-2

Unit: mm [inch]

Type	L	W	T	a	A	B	C
1005 [0402]	1.0±0.15 [0.039±0.006]	0.5±0.15 [0.020±0.006]	0.5±0.15 [0.020±0.006]	0.25±0.1 [0.010±0.004]	0.45~0.55	0.40~0.50	0.45~0.55



- ① ZnO for chip varistor
- ② Internal electrode (Ag-Pd)
- ③-1 Terminal electrode: Inside (Ag)
- ③-2 Outside (Electro-plating Ni-Sn)

Part Number	Max. Working Voltage		Varistor Voltage	Max. Clamping Voltage		Rated Single Pulse Transient		Typical Capacitance
	DC	AC RMS		8/20µs	ESD	Energy 10/1000µs	Peak Current 8/20µs	
Test Condition	<20µA		@1mA DC	8/20µs	ESD	Energy 10/1000µs	Peak Current 8/20µs	@0.5V <sub>rms</sub> , 1MHz
Units	Volts	Volts						
Symbol	V <sub>WDC</sub>	V <sub>WAC</sub>	V <sub>B</sub>	V <sub>C</sub> <sup>-1</sup>	V <sub>C</sub> <sup>-2</sup>	E <sub>T</sub>	I <sub>P</sub>	C
KMOV0402E180C030T	18.0	12.7	31.0-38.0	58	70	0.003	1	3

**3. Test and Measurement Procedures**

**3.1 Test Conditions**

3.1.1 Unless otherwise specified, the standard atmospheric conditions for measurement/test as:

- a. Ambient Temperature: 20±15℃.
- b. Relative Humidity: 65±20%.
- c. Air Pressure: 86kPa to 106kPa.

3.1.2 If any doubt on the results, measurements/tests should be made within the following limits:

- a. Ambient Temperature: 20±2℃
- b. Relative Humidity: 65±5%.
- c. Air Pressure: 86kPa to 106kPa.

**3.2 Visual Examination**

- a. Inspection Equipment: 20× magnifier.

**3.3 Electrical Test**

Items	Requirements	Test Methods and Remarks
3.3.1 Varistor Voltage at 1mA DC ( $V_B$ )	Refer to <b>Appendix A</b>	Measuring current: 1mA DC Duration: 0.2 to 2 sec
3.3.2 Capacitance (C)	Refer to <b>Appendix A</b>	Measure source: 0.5 $V_{RMS}$ Test frequency: 1MHz.
3.3.3 Leakage Current ( $I_L$ )	Refer to <b>Appendix A</b>	Measuring voltage: Maximum DC working voltage
3.3.4 Clamping Voltage ( $V_C$ )	Refer to <b>Appendix A</b>	Measuring source: 8/20us waveform, ESD waveform

**3.4 Reliability Test**

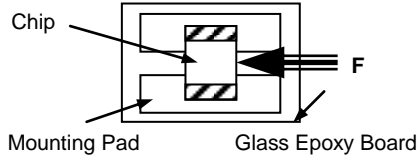
Items	Requirements	Test Methods and Remarks
3.4.1. Terminal Strength	<p>No removal or split of the termination or other defects shall occur.</p>  <p style="text-align: center;"><b>Fig.5.4.1-1</b></p>	<ul style="list-style-type: none"> <li>① Solder the chip to the testing jig (glass epoxy board shown in <b>Fig.5.4.1-1</b>) using eutectic solder. Then apply a force in the direction of the arrow.</li> <li>② 5N force for SDV1005 and 1608 series, 10N force for SDV2012 and 3216 series.</li> <li>③ Keep time: 10±1s.</li> </ul>

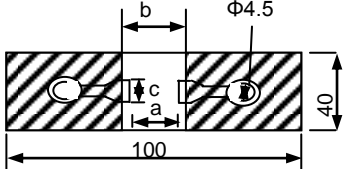
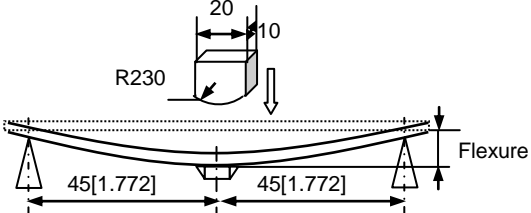
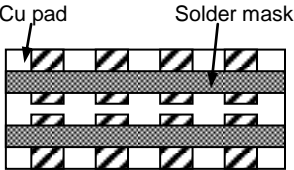
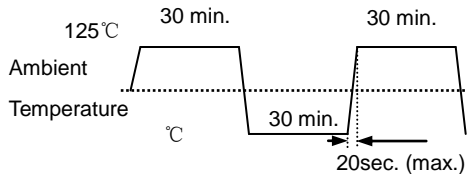
<p>3.4.2 Resistance to Flexure</p>	<p>No visible mechanical damage.</p> <table border="1" data-bbox="304 170 711 389"> <thead> <tr> <th>Type</th> <th>a</th> <th>b</th> <th>c</th> </tr> </thead> <tbody> <tr> <td>1005[0402]</td> <td>0.4</td> <td>1.5</td> <td>0.5</td> </tr> <tr> <td>1608[0603]</td> <td>1.0</td> <td>3.0</td> <td>1.2</td> </tr> <tr> <td>2012[0805]</td> <td>1.2</td> <td>4.0</td> <td>1.65</td> </tr> <tr> <td>3216[1206]</td> <td>2.2</td> <td>5.0</td> <td>2.0</td> </tr> </tbody> </table> <p>Unit: mm [inch]</p>  <p>Fig.3.4.2-1</p>	Type	a	b	c	1005[0402]	0.4	1.5	0.5	1608[0603]	1.0	3.0	1.2	2012[0805]	1.2	4.0	1.65	3216[1206]	2.2	5.0	2.0	<ol style="list-style-type: none"> <li>Solder the chip to the test jig (glass epoxy board shown in Fig.3.4.2-1) using a eutectic solder. Then apply a force in the direction shown in Fig.3.4.2-2.</li> <li>Flexure: 2mm.</li> <li>Pressurizing Speed: 0.5mm/sec.</li> <li>Keep time: 30 sec.</li> </ol>  <p>Fig.5.4.2-2</p>
Type	a	b	c																			
1005[0402]	0.4	1.5	0.5																			
1608[0603]	1.0	3.0	1.2																			
2012[0805]	1.2	4.0	1.65																			
3216[1206]	2.2	5.0	2.0																			
<p>3.4.3 Vibration</p>	<p>No visible mechanical damage.</p>  <p>Glass Epoxy Board Fig. 3.4.3-1</p>	<ol style="list-style-type: none"> <li>Solder the chip to the testing jig (glass epoxy board shown in Fig.3.4.3-1) using eutectic solder.</li> <li>The chip shall be subjected to a simple harmonic motion having total amplitude of 1.5mm, the frequency being varied uniformly between the approximate limits of 10 and 55 Hz.</li> <li>The frequency range from 10 to 55 Hz and return to 10 Hz shall be traversed in approximately 1 minute. This motion shall be applied for a period of 2 hours in each 3 mutually perpendicular directions (total of 6 hours).</li> </ol>																				
<p>3.4.4 Solderability</p>	<ol style="list-style-type: none"> <li>No visible mechanical damage.</li> <li>Wetting shall exceed 90% coverage.</li> </ol>	<ol style="list-style-type: none"> <li>Solder temperature: 240±2℃</li> <li>Duration: 3 sec.</li> <li>Solder: Sn/3.0Ag/0.5Cu.</li> <li>Flux: 25% Resin and 75% ethanol in weight.</li> </ol>																				
<p>3.4.5 Resistance to Soldering Heat</p>	<ol style="list-style-type: none"> <li>No visible mechanical damage.</li> <li>Varistor voltage change: within ±10%.</li> </ol>	<ol style="list-style-type: none"> <li>Solder temperature: 260±3℃</li> <li>Duration: 5 sec.</li> <li>The chip shall be stabilized at normal condition for 1~2hours before measuring.</li> <li>Solder: Sn/3.0Ag/0.5Cu.</li> <li>Flux: 25% Resin and 75% ethanol in weight.</li> </ol>																				
<p>3.4.6 Thermal Shock</p>	<ol style="list-style-type: none"> <li>No visible mechanical damage.</li> <li>Varistor voltage change: within ±10%.</li> </ol> 	<ol style="list-style-type: none"> <li>Temperature, Time: -55℃ for 30±3 min→125℃ for 30±3min.</li> <li>Transforming interval: 20sec. (max.)</li> <li>Tested cycle: 100 cycles.</li> <li>The chip shall be stabilized at normal condition for 1~2 hours before measuring.</li> </ol>																				
<p>3.4.7 Resistance to Low Temperature</p>	<ol style="list-style-type: none"> <li>No visible mechanical damage.</li> <li>Varistor voltage change: within ±10%.</li> </ol>	<ol style="list-style-type: none"> <li>Temperature: -55±2℃</li> <li>Duration: 1000<sup>+24</sup> hours.</li> <li>The chip shall be stabilized at normal condition for 1~2 hours before measuring.</li> </ol>																				
<p>3.4.8 Resistance to High Temperature</p>	<ol style="list-style-type: none"> <li>No visible mechanical damage.</li> <li>Varistor voltage change: within ±10%.</li> </ol>	<ol style="list-style-type: none"> <li>Temperature: 125±2℃.</li> <li>Duration: 1000<sup>+24</sup> hours.</li> <li>The chip shall be stabilized at normal condition for 1~2 hours before measuring.</li> </ol>																				
<p>3.4.9 Damp Heat (Steady States)</p>	<ol style="list-style-type: none"> <li>No visible mechanical damage.</li> <li>Varistor voltage change: within ±10%.</li> </ol>	<ol style="list-style-type: none"> <li>Temperature: 60±2℃</li> <li>Humidity: 90% to 95% RH.</li> <li>Duration: 1000<sup>+24</sup> hours.</li> <li>The chip shall be stabilized at normal condition for 1~2 hours before measuring.</li> </ol>																				

3.4.10 Loading Under Damp Heat	<ul style="list-style-type: none"> <li>① No visible mechanical damage.</li> <li>② Varistor voltage change: within <math>\pm 10\%</math>.</li> </ul>	<ul style="list-style-type: none"> <li>① Temperature: <math>60\pm 2^{\circ}\text{C}</math></li> <li>② Humidity: 90% to 95% RH.</li> <li>③ Duration: <math>1000^{+24}</math> hours.</li> <li>④ Applied voltage: DC Working Voltage.</li> <li>⑤ The chip shall be stabilized at normal condition for 1~2 hours before measuring.</li> </ul>
3.4.11 Loading at High Temperature (Life Test)	<ul style="list-style-type: none"> <li>① No visible mechanical damage.</li> <li>② Varistor voltage change: within <math>\pm 10\%</math>.</li> </ul>	<ul style="list-style-type: none"> <li>① Temperature: <math>125\pm 2^{\circ}\text{C}</math></li> <li>② Duration: <math>1000^{+24}</math> hours.</li> <li>③ Applied voltage: DC Working Voltage.</li> <li>④ The chip shall be stabilized at normal condition for 1~2 hours before measuring.</li> </ul>
3.4.12 Maximum Surge Current	<ul style="list-style-type: none"> <li>① No visible mechanical damage.</li> <li>② Varistor voltage change: within <math>\pm 10\%</math>. IEC61000-4-5 standard 1.2/50us-8/20us voltage-current combination pulse</li> </ul>	<ul style="list-style-type: none"> <li>① Temperature: <math>25\pm 5^{\circ}\text{C}</math></li> <li>② Humidity: 30% to 65% RH.</li> <li>③ Number of hit: each 1 time of +/- polarity.</li> <li>④ Pulse waveform: 8/20 us.</li> <li>⑤ Applied current: maximum surge current (<math>I_p</math>).</li> <li>⑥ The chip shall be stabilized at normal condition for 1~2 hours before measuring.</li> </ul>
3.4.13 Maximum Surge Energy	<ul style="list-style-type: none"> <li>① No visible mechanical damage.</li> <li>② Varistor voltage change: within <math>\pm 10\%</math>. IEC61000-4-5 standard 10/1000us current pulse</li> </ul>	<ul style="list-style-type: none"> <li>① Temperature: <math>25\pm 5^{\circ}\text{C}</math></li> <li>② Humidity: 30% to 65% RH.</li> <li>③ Number of hit: 1 time.</li> <li>④ Pulse waveform: 10/1000 us.</li> <li>⑤ Applied energy: maximum surge energy (<math>E_T</math>).</li> <li>⑥ The chip shall be stabilized at normal condition for 1~2 hours before measuring.</li> </ul>
3.4.14 ESD Life	<ul style="list-style-type: none"> <li>① No visible mechanical damage.</li> <li>② Varistor voltage change: within <math>\pm 10\%</math>. IEC61000-4-2 standard ESD gun C=150pF R=330<math>\Omega</math></li> </ul>	<ul style="list-style-type: none"> <li>① Discharge: Contact discharge.</li> <li>② Voltage: 8000V (Level 4).</li> <li>③ Polarity: +, -.</li> <li>④ Number: 10 times within 10 sec.</li> <li>⑤ The chip shall be stabilized at normal condition for 1~2 hours before measuring.</li> </ul>
3.4.15 ESD Test	<ul style="list-style-type: none"> <li>① No visible mechanical damage.</li> <li>② Varistor voltage change: within <math>\pm 10\%</math>. IEC61000-4-2 standard ESD gun C=150pF R=330<math>\Omega</math></li> </ul>	<ul style="list-style-type: none"> <li>① Discharge: Air discharge.</li> <li>② Voltage: 15000V (Special level).</li> <li>③ Polarity: +, -</li> <li>④ Number: 10 times within 10 sec.</li> <li>⑤ The chip shall be stabilized at normal condition for 1~2 hours before measuring.</li> </ul>

**4. Recommended Soldering Technologies**

**4.1 Reflow Profile:**

- △ Preheat condition: 150 ~200°C/60~120sec.
- △ Allowed time above 217°C: 60~90sec.
- △ Max temp: 260°C
- △ Max time at max temp: 10sec.
- △ Solder paste: Sn/3.0Ag/0.5Cu
- △ Allowed Reflow time: 2x max

[Note: The reflow profile in the above table is only for qualification and is not meant to specify board assembly profiles. Actual board assembly profiles must be based on the customer's specific board design, solder paste and process, and should not exceed the parameters as the Reflow profile shows.]

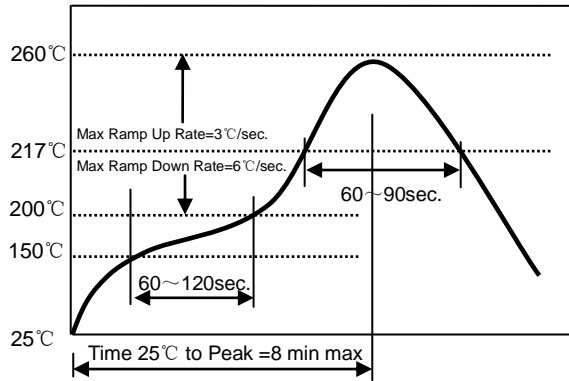

**4.2 Iron Soldering Profile.**

- △ Iron soldering power: Max.30W
- △ Pre-heating: 150 °C / 60 sec.
- △ Soldering Tip temperature: 350°C Max.
- △ Soldering time: 3 sec Max.
- △ Solder paste: Sn/3.0Ag/0.5Cu
- △ Max.1 times for iron soldering

[Note: Take care not to apply the tip of the soldering iron to the terminal electrodes.]

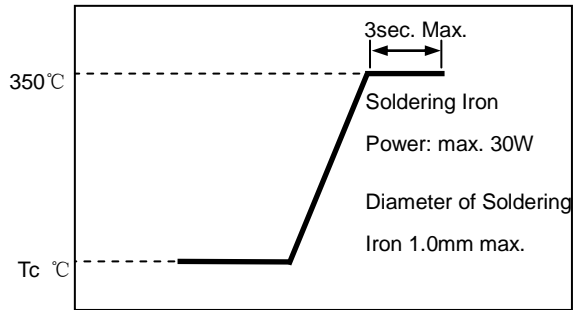

**5.characteristic curves of chip varistor**

