

Surface Mount Schottky Barrier Rectifier

Reverse Voltage - 20 to 200 V

Forward Current - 1.0 A

FEATURES

- Metal silicon junction, majority carrier conduction
- For surface mounted applications
- Low power loss, high efficiency
- High forward surge current capability
- For use in low voltage, high frequency inverters, free wheeling, and polarity protection applications

MECHANICAL DATA

- Case: SMAF
- Terminals: Solderable per MIL-STD-750, Method 2026
- Approx. Weight: 27mg/0.00095oz

PINNING

| PIN | DESCRIPTION |
|-----|-------------|
| 1 | Cathode |
| 2 | Anode |



Top View

Simplified outline SMAF and symbol

Absolute Maximum Ratings and Electrical characteristics

Ratings at 25 °C ambient temperature unless otherwise specified. Single phase, half wave, 60Hz resistive or inductive load, for capacitive load, derate by 20 %

| Parameter | Symbols | SS12F | SS14F | SS16F | SS18F | SS110F | SS112F | SS115F | SS120F | Units |
|---|-----------------|------------|-------|-------|-------|--------|--------|--------|--------|-------|
| Maximum Repetitive Peak Reverse Voltage | V_{RRM} | 20 | 40 | 60 | 80 | 100 | 120 | 150 | 200 | V |
| Maximum RMS voltage | V_{RMS} | 14 | 28 | 42 | 56 | 70 | 84 | 105 | 140 | V |
| Maximum DC Blocking Voltage | V_{DC} | 20 | 40 | 60 | 80 | 100 | 120 | 150 | 200 | V |
| Maximum Average Forward Rectified Current | $I_{F(AV)}$ | 1.0 | | | | | | | | A |
| Peak Forward Surge Current, 8.3ms Single Half Sine-wave Superimposed on Rated Load (JEDEC method) | I_{FSM} | 25 | | | | | | | | A |
| Max Instantaneous Forward Voltage at 1 A | V_F | 0.55 | 0.70 | | 0.85 | | 0.90 | | V | |
| Maximum DC Reverse Current $T_a = 25^\circ\text{C}$ at Rated DC Reverse Voltage $T_a = 100^\circ\text{C}$ | I_R | 0.3 | | | 0.2 | | 0.1 | | mA | |
| | | 10 | | | 5 | | 2 | | | |
| Typical Junction Capacitance ⁽¹⁾ | C_j | 110 | 80 | | | | | | | pF |
| Typical Thermal Resistance ⁽²⁾ | $R_{\theta JA}$ | 95 | | | | | | | | °C/W |
| Operating Junction Temperature Range | T_j | -55 ~ +125 | | | | | | | | °C |
| Storage Temperature Range | T_{stg} | -55 ~ +150 | | | | | | | | °C |

(1) Measured at 1 MHz and applied reverse voltage of 4 V D.C

(2) P.C.B. mounted with 2.0" X 2.0" (5 X 5 cm) copper pad areas.

Fig.1 Forward Current Derating Curve

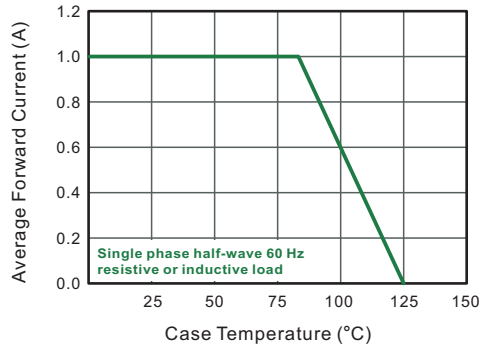

Fig.2 Typical Reverse Characteristics

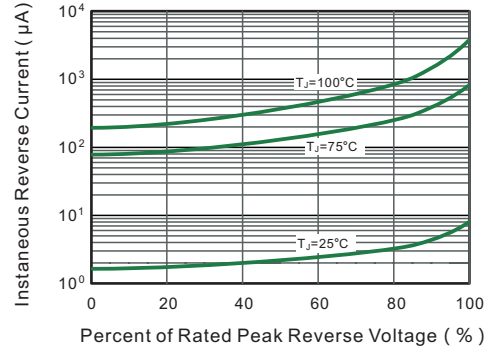

Fig.3 Typical Forward Characteristic

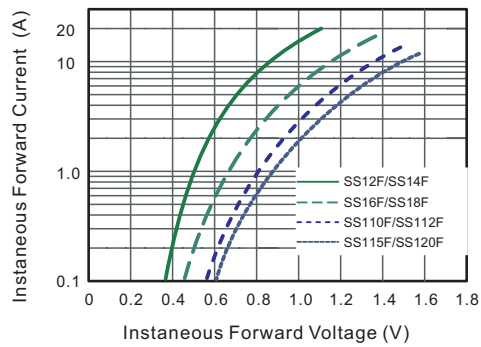

Fig.4 Typical Junction Capacitance

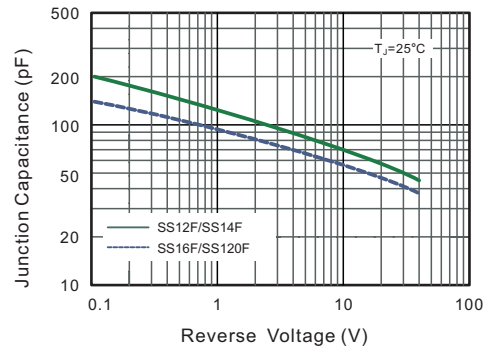

Fig.5 Maximum Non-Repetitive Peak Forward Surge Current

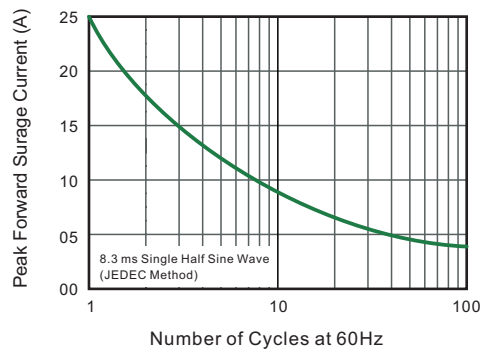
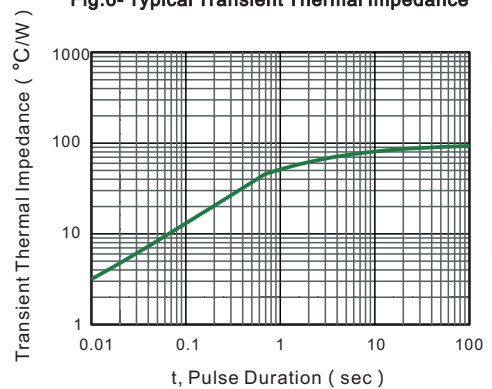
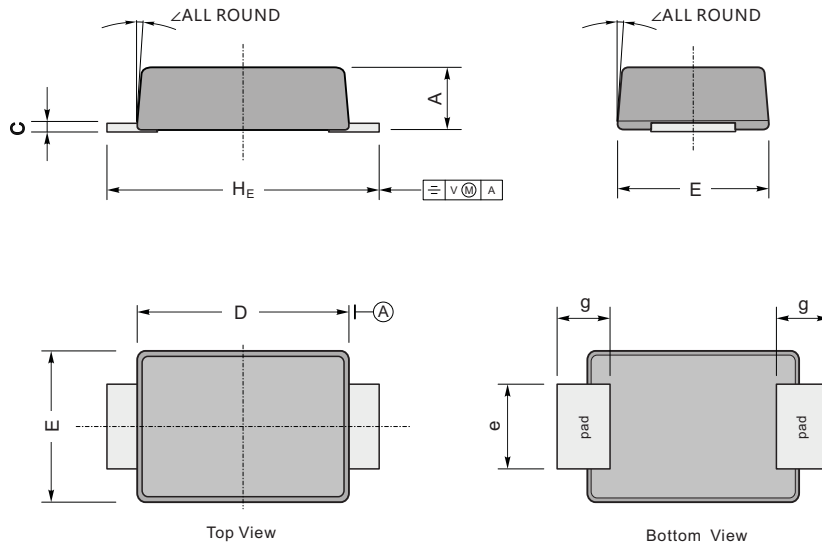

Fig.6- Typical Transient Thermal Impedance



PACKAGE OUTLINE

Plastic surface mounted package; 2 leads



| UNIT | | A | C | D | E | e | g | H_E | \angle |
|------|-----|-----|------|-----|-----|-----|-----|-------|----------|
| mm | max | 1.2 | 0.20 | 3.7 | 2.7 | 1.6 | 1.2 | 4.9 | 7° |
| | min | 0.9 | 0.12 | 3.3 | 2.4 | 1.3 | 0.8 | 4.4 | |
| mil | max | 47 | 7.9 | 146 | 106 | 63 | 47 | 193 | |
| | min | 35 | 4.7 | 130 | 94 | 51 | 31 | 173 | |

The recommended mounting pad size

