

Product Summary

- V_{DS} 100 V
- I_{DS} (@ $V_{GS}=10V$) 8A
- $R_{DS(ON)}$ (@ $V_{GS}=10V$) $\leq 24m\Omega$

Application

- LED Backlighting
- Synchronous Rectifiers for SMPS
- Power management
- PWM Application

Reference: AM4492N

Package and Pin Configuration

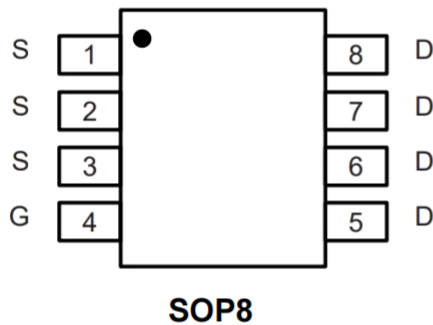

Circuit diagram

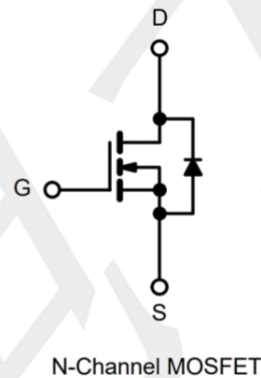

Absolute Maximum Ratings (T_A=25°C unless otherwise noted)

PARAMETER	SYMBOL	LIMIT	UNIT
Drain-Source Voltage	V_{DS}	100	V
Gate-Source Voltage	V_{GS}	± 20	V
Continuous Drain Current	I_D	8	A
Continuous Drain Current	I_D	6	A
Pulsed Drain Current (note1)	I_{DM}	32	A
Single Pulse Avalanche Energy	EAS	80	mJ
Maximum Power Dissipation, T _A =25°C	P_D	3.5	W
Operating Junction Temperature Range	T_J	-55 to +150	°C
Storage Temperature Range	T_{stg}	-55 to +150	°C

Thermal Characteristic

PARAMETER	Symbol	Value	Unit
Thermal Resistance Junction-ambient	$R_{\theta JA}$	70	°C/W
Thermal Resistance Junction-Case	$R_{\theta JC}$	36	°C/W

notes 1. Repetitive Rating: Pulse width limited by maximum junction temperature.

2. When mounted on 1" square PCB (FR4 material).

Electrical Characteristics ($T_A=25^\circ\text{C}$ unless otherwise noted)

PARAMETER	CONDITIONS	SYMBOL	MIN	TYP	MAX	UNIT
Static						
Drain-Source Breakdown Voltage	$V_{GS}=0V, I_D=250\mu A$	BV_{DSS}	100	--	--	V
Gate-Source Threshold Voltage	$V_{DS}=V_{GS}, I_D=250\mu A$	$V_{GS(th)}$	1.0	2.0	3.0	V
Gate-Source Leakage	$V_{DS}=0V, V_{GS}=\pm 20V$	I_{GSS}	--	--	± 100	nA
Zero Gate Voltage Drain Current	$V_{DS}=100V, V_{GS}=0V$	I_{DSS}	--	--	1	μA
	$V_{DS}=100V, T_J=85^\circ C$		--	--	30	μA
Drain-Source On-State Resistance (Note 1)	$V_{GS}=10V, I_D=8A$	$R_{DS(on)}$	--	20	24	m Ω
	$V_{GS}=4.5V, I_D=6A$		--	24	32	
Forward Transconductance (Note 2)	$V_{DS}=5V, I_D=3A$	g_{fs}	--	25	--	S
Dynamic (Note 2)						
Total Gate Charge (Note 3)	$V_{DS}=80V, I_D=8A, V_{GS}=10V$	Q_g	--	78	--	nC
Gate-Source Charge (Note 3)		Q_{gs}	--	8.0	--	
Gate-Drain Charge (Note 3)		Q_{gd}	--	15	--	
Input Capacitance	$V_{DS}=25V, V_{GS}=0V, F=1.0MHz$	C_{iss}	--	3400	--	pF
Output Capacitance		C_{oss}	--	110	--	
Reverse Transfer Capacitance		C_{rss}	--	90	--	
Switching						
Turn-On Delay Time (Note 3)	$V_{DD}=50V, I_D=8A, V_{GS}=10V, R_G=6\Omega$	$t_{d(on)}$	--	20	--	nS
Rise Time (Note 3)		t_r	--	14	--	
Turn-Off Delay Time (Note 3)		$t_{d(off)}$	--	44	--	
Fall Time (Note 3)		t_f	--	12	--	
Source-Drain Diode Ratings and Characteristics (Note 2)						
Forward Voltage	$V_{GS}=0V, I_{SD}=4A$	V_{SD}	--	0.8	1.3	V
Continuous Source Current	Integral reverse diode in the MOSFET	I_S	--	--	8	A
Pulsed Current (Note 1)		I_{SM}	--	--	32	A

Notes:

1. Pulse test; pulse width $\leq 300 \mu S$, duty cycle $\leq 2\%$.
2. Guaranteed by design, not subject to production testing.
3. Independent of operating temperature

TYPICAL CHARACTERISTICS (25 °C, unless otherwise noted)

Output Characteristics

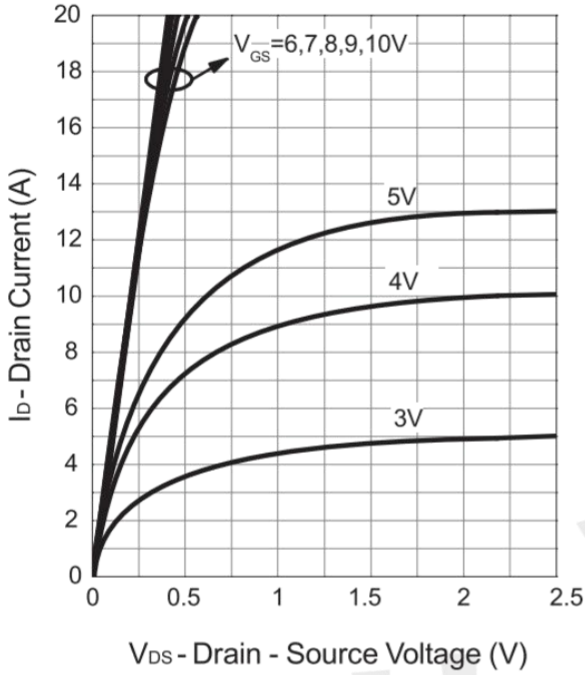

Drain-Source On Resistance

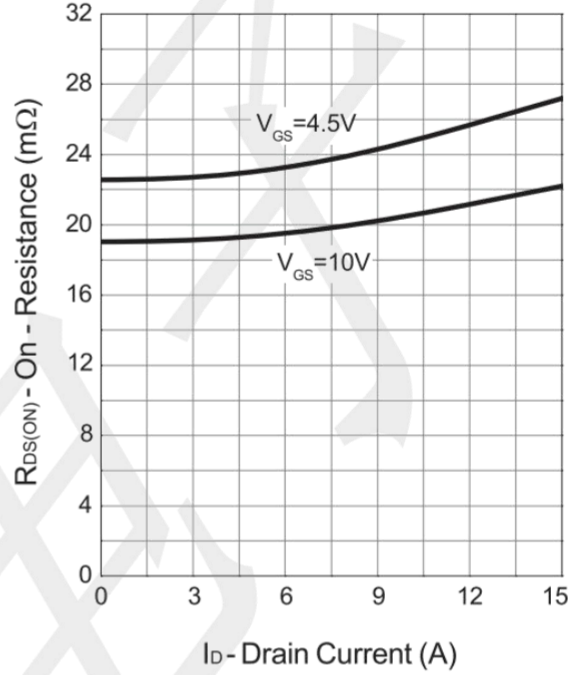

Gate-Source On Resistance

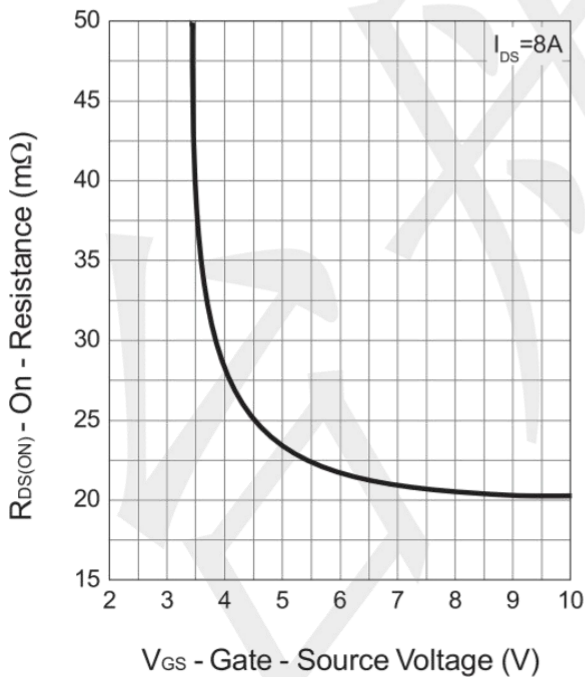

Gate Threshold Voltage

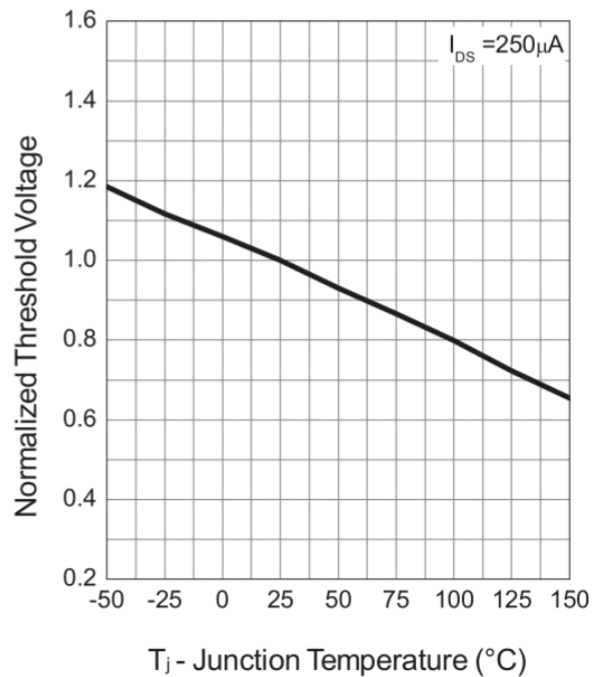

TYPICAL CHARACTERISTICS (25 °C, unless otherwise noted)

Drain-Source On Resistance

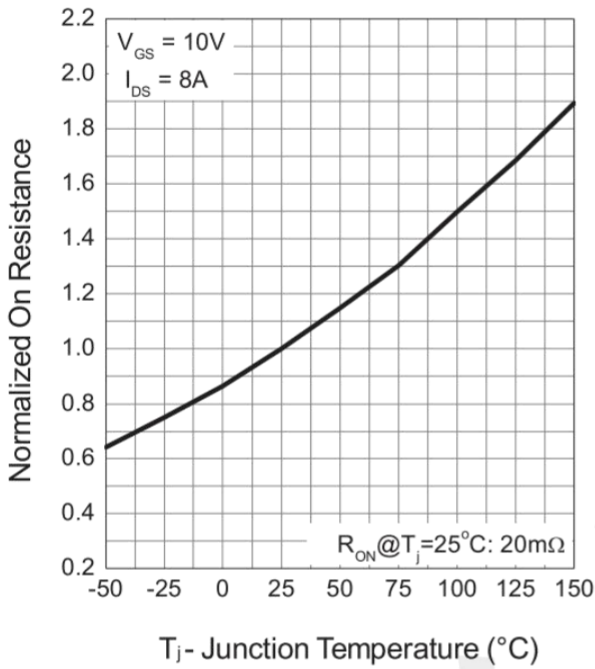

Source-Drain Diode Forward

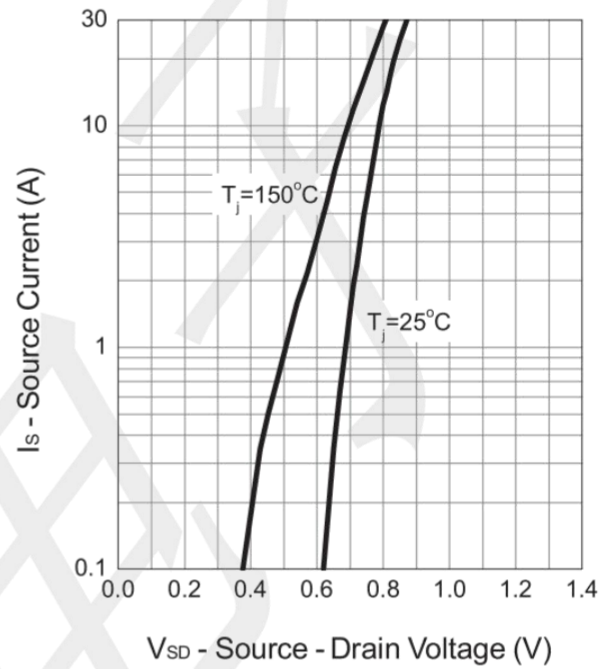

Capacitance

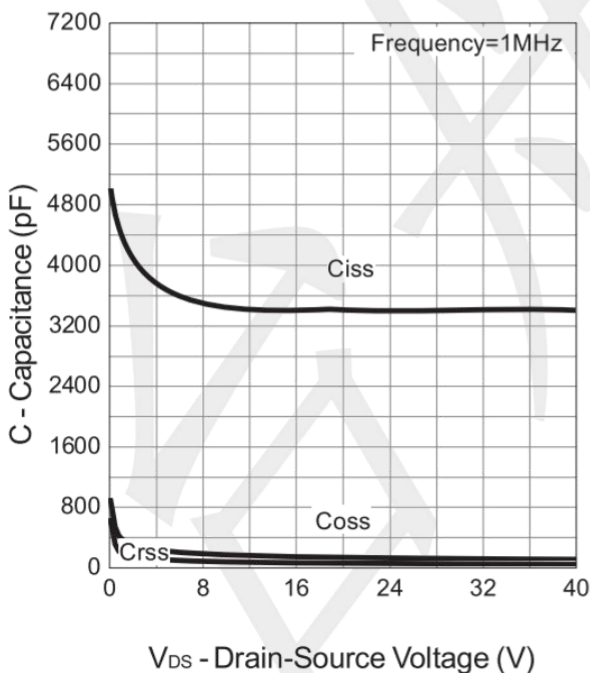

Gate Charge

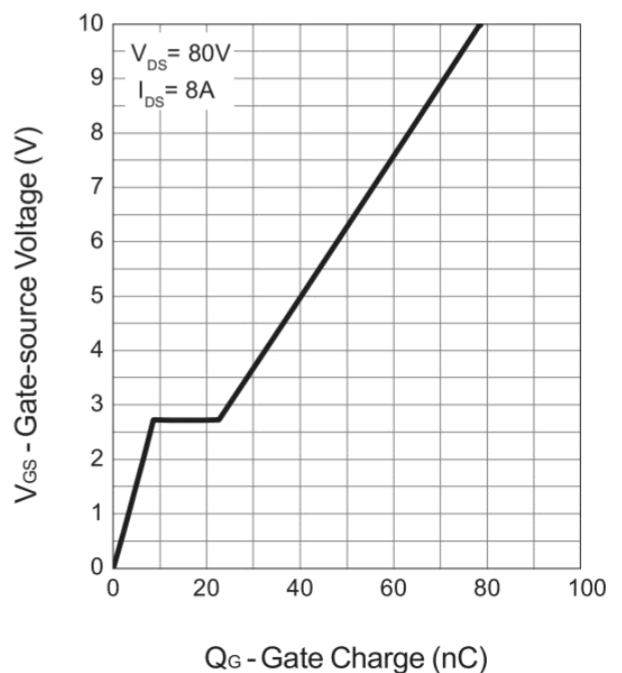

Package Information

SOP8

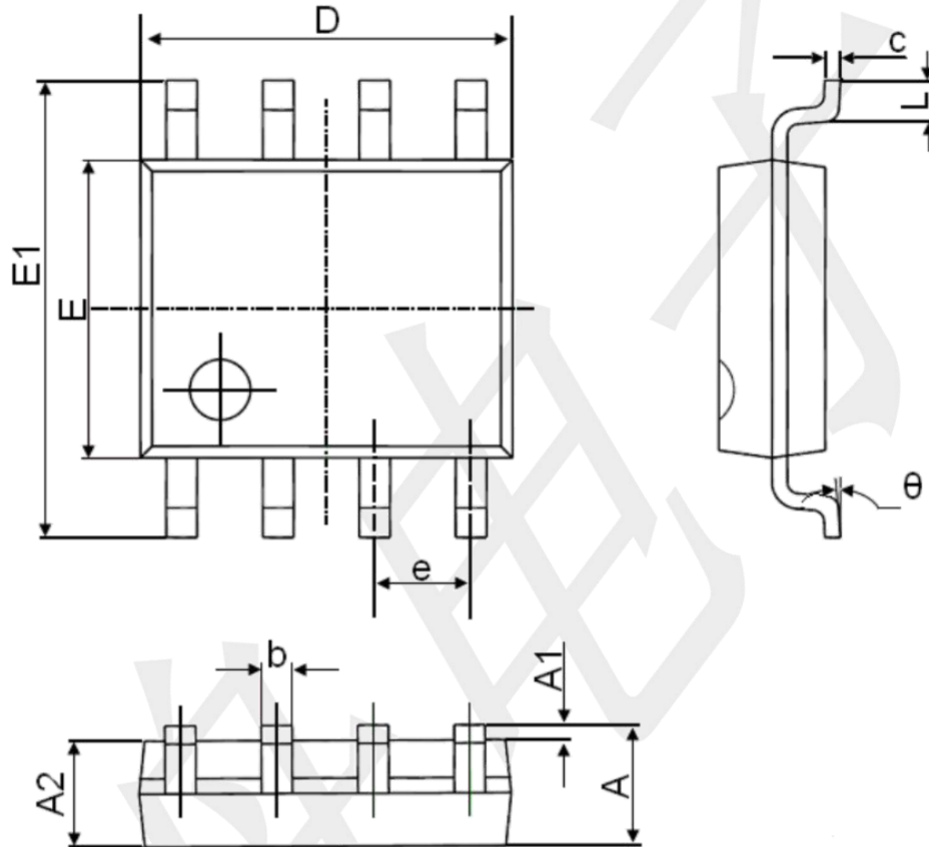

Symbol	Dimensions In Millimeters		Dimensions In Inches	
	Min.	Max.	Min.	Max.
A	1.350	1.750	0.053	0.069
A1	0.100	0.250	0.004	0.010
A2	1.350	1.550	0.053	0.061
b	0.330	0.510	0.013	0.020
c	0.170	0.250	0.006	0.010
D	4.700	5.100	0.185	0.200
E	3.800	4.000	0.150	0.157
E1	5.800	6.200	0.228	0.244
e	1.270(BSC)		0.050(BSC)	
L	0.400	1.270	0.016	0.050
θ	0°	8°	0°	8°