

Jun.1.2024 Copyright 2024 HIROSE ELECTRIC CO., LTD. All Rights Reserved.
In case of consideration for using Automotive equipment / device which demand high reliability, kindly contact our sales window correspondents.

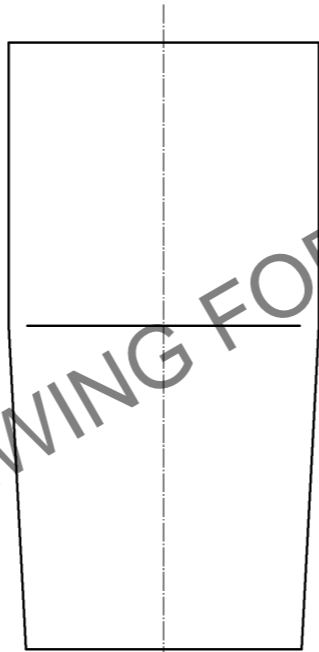

1> FIGURE-1 CONTACT No. MARKING (10:1)

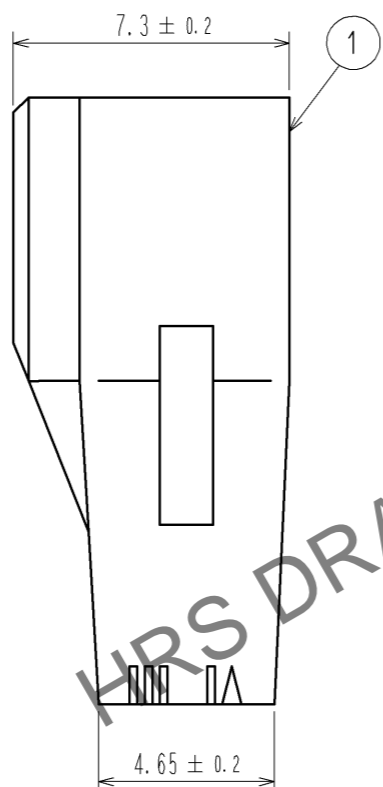
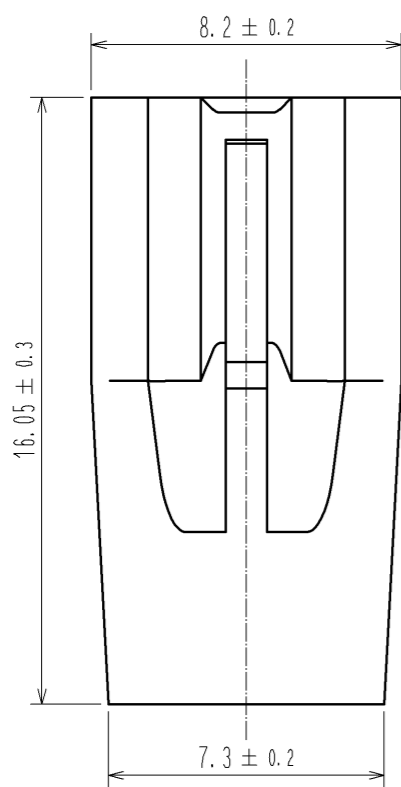
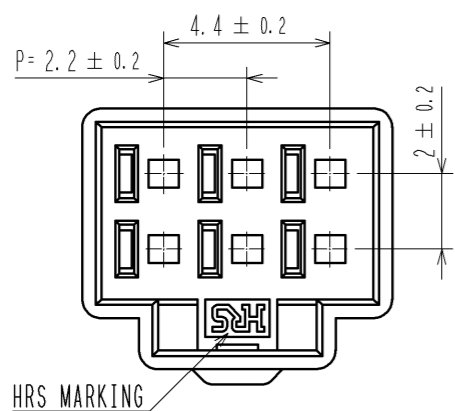
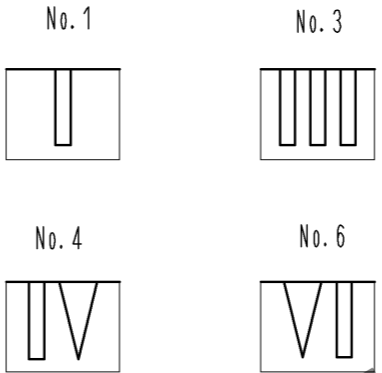

MATING FIGURE

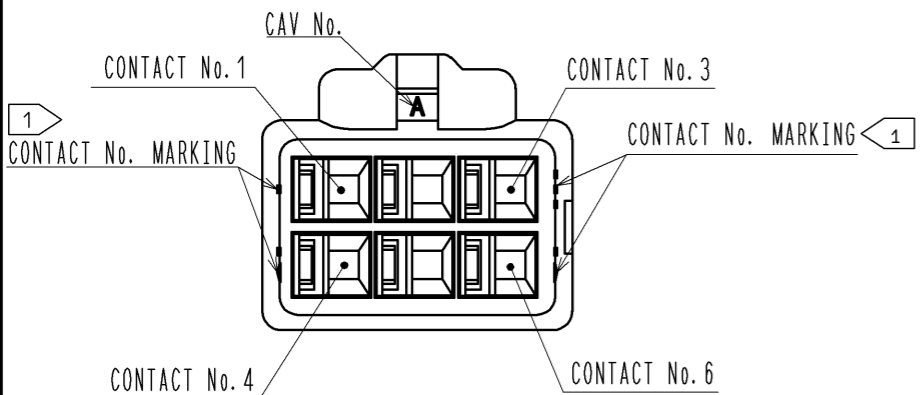
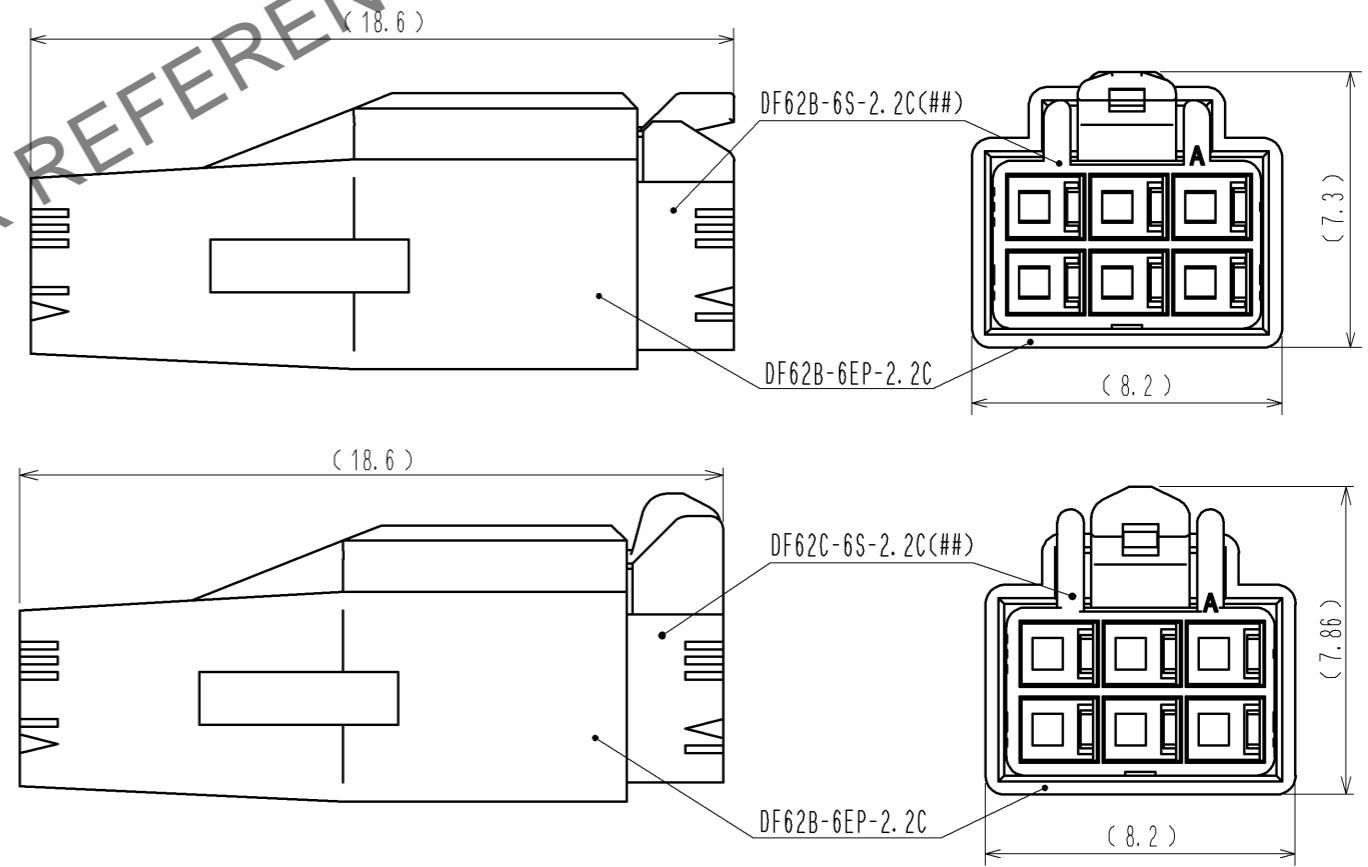

NOTE. 1> MARKINGS AT THE INDICATED POSITIONS ARE CONTACT NO. MARKING. AND SHAPES ARE SHOWN IN FIGURE-1.
2. PER PACK : 100 PIECES.
3. THE DIMENSIONS IN PARENTHESIS ARE FOR REFERENCE.

NO.		MATERIAL		FINISH . REMARKS		1	PBT	UL94V-0 (BLACK)	
UNITS mm		SCALE 5 : 1		COUNT		DESCRIPTION OF REVISIONS		DESIGNED	CHECKED
HIROSE ELECTRIC CO., LTD.		APPROVED : KI. AKIYAMA		13.05.28		DRAWING NO.		EDC3-351967-00	
		CHECKED : HK. UMEHARA		13.05.28		PART NO.		DF62B-6EP-2.2C	
		DESIGNED : TS. KUMAZAWA		13.05.28		CODE NO.		CL544-0562-6-00	
		DRAWN : TS. KUMAZAWA		13.05.28					