

M-Series

Hydraulic-Magnetic Circuit Breaker

PRODUCT WEBPAGE

request sample, configure part



Miniature Circuit Breaker

The M-Series hydraulic-magnetic circuit breakers offer high performance in a compact, front panel mount design. Multiple agency approvals and options for terminals, panel hardware and actuator styles allow for extensive design flexibility. Wiping contacts assure longevity. These miniature circuit breakers are available as a one to two or parallel pole configuration, rated from 0.02 to 50 amps, up to 250VAC/80VDC with a max IC of 1,000 amps; 600 amps TUV and 500 amps VDE.

1-2	0.2-50	125/250	80
Poles	Amps	VAC Max	VDC Max

Typical Applications

- Telecom
- Marine
- Power Supplies
- Commercial Food
- Transportation
- Generators
- Medical Equipment

Tech Specs

Electrical

Maximum Voltage	125/250 VAC 50/60 Hz, 80 VDC (See Rating Tables.)
Current Ratings	Standard current coils: 0.100, 0.250, 0.500, 0.750, 1.00 thru 15.0 in 1 amp increments, 18.0, 20.0, 25.0, 30.0. Other ratings available - see Ordering Scheme.
Standard Voltage Coils	DC - 6V, 12V; AC - 120V, other ratings available, see ordering scheme.
Auxiliary Switch Rating	SPDT; 7A 250VAC, 7A (Res) 28VDC, 4A (Ind.) 28VDC, 0.25A 80VDC (Res) (silver contacts), 0.1A 125VAC (gold contacts).
Insulation Resistance	Minimum of 100 Megohms at 500 VDC.
Dielectric Strength	UL, CSA 1500V, 50/60 Hz for one minute between all electrically isolated terminals. M-Series Circuit Breakers comply with the 8mm spacing and 3750 V 50/60Hz dielectric requirements from hazardous voltage to operator accessible surfaces, per Publications IEC 380, 435, 950, EN 60950 and VDE 0805.
Resistance, Impedance	Values from Line to Load Terminal - based on Series Trip Circuit Breaker.

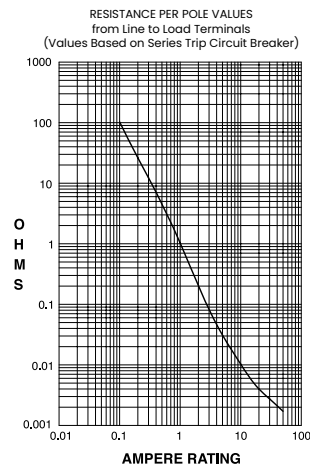

CURRENT (AMPS)	TOLERANCE (%)
0.10 - 20.0	± 25
20.1 - 50.0	± 35

Pulse Tolerance Curves

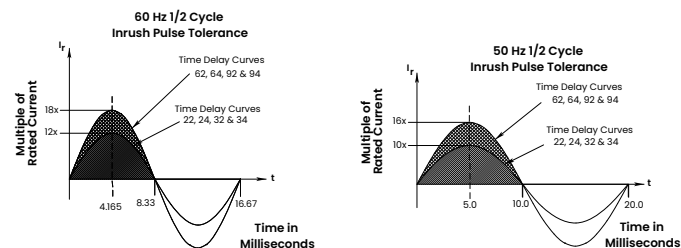

Mechanical

Endurance	10,000 ON-OFF operations @ 6 per minute with rated Current and Voltage.
Trip Free	All M-Series Circuit Breakers will trip on overload, even when actuator is forcibly held in the ON position.
Trip Indication	The actuator moves positively to the OFF position when an overload causes the circuit breaker to trip.
Number of Poles	1 or 2
Internal Circuit Config.	Series with or without Auxiliary Switch. Switch Only with or without Auxiliary Switch.
Weight	Approximately 30 grams/pole (Approximately 1.07 ounces/pole)
Standard Colors	See Ordering Scheme

Environmental

Designed in accordance with requirements of specification MIL PRF-55629 & MIL-STD-202G as follows:

Shock	Withstands 100 Gs, 6ms, sawtooth while carrying rated current per Method 213, Cond. I. Instantaneous curves tested at 80% of rated current.
Vibration	Withstands 0.060" excursion from 10-55 Hz, and 10 Gs 55-500 Hz, at rated current per Method 204C, Test Condition A. Instantaneous curves tested at 80% of rated current.
Moisture Resistance	Method 106D, i.e., ten 24-hour cycles @ + 25°C to +65°C, 80-98% RH.
Salt Spray	Method 101, Condition A (90-95% RH @ 5% NaCl Solution, 96 hrs).
Thermal Shock	Method 107D, Condition A (Five cycles @ -55°C to +25°C to +85°C to +25°C).
Operating Temperature	-40° C to +85° C
Chemical Resistance	Only the outside surfaces of the case and the handles may be cleaned with detergents or alcohol. Organic (hydrocarbon based) solvents are not recommended because they attack plastics. Caution should be taken when solvents are used to clean and remove flux from terminals. Lubricants should not be introduced into the handle/bushing openings

Tech Specs

Tables

Table A: Lists UL Recognized and CSA Accepted configurations & performance capabilities as a Component Supplementary Protector.

Component Supplementary Protectors												
Circuit Configuration	Voltage			Current Rating		Poles Breaking	Short Circuit Capacity (Amps)				Application Codes	
	Max Rating	Frequency	Phase	Full Load Amps	General Purpose Amps		UL / CSA		Without Backup Fuse	UL	CSA	
							With Backup Fuse	Without Backup Fuse				
Series	32	DC	---	0.02 - 15	---	1	---	1000		TC1, 2, OL1, UI	TC1, 2, OL1, UI	
				---	15.1 - 25					TC1, 2, OL0, UI	TC1, 2, OL0, UI	
	50 ²			0.02 - 7.5	---	TC1, 2, OL0, UI				TC1, 2, OL0, UI		
				65	0.02 - 15	---				2	TC1, 2, OL1, UI	TC1, 2, OL1, UI
	---				15.1 - 25	TC1, 2, OL0, UI					TC1, 2, OL0, UI	
	65 ^{1,2}			0.02 - 15	---	1				TC1, 2, OL1, UI	TC1, 2, OL1, UI	
		---	15.1 - 30	TC1, 2, OL0, UI	TC1, 2, OL0, UI							
	65	50 / 60	1	0.02 - 15	---	2	5000 ³	---	TC1, 2, OL1, C1	TC1, 2, OL1, C1		
				---	15.1 - 25				TC1, 2, OL0, C1	TC1, 2, OL0, C1		
	80 ¹			0.02 - 15	---	1			600	TC1, 2, OL1, UI	TC1, 2, OL1, UI	
				---	15.1 - 30					TC1, 2, OL0, UI	TC1, 2, OL0, UI	
	125			0.02 - 15	---	1			1000	TC1, 2, OL1, UI	TC1, 2, OL1, UI	
				---	15.1 - 30					TC1, 2, OL0, UI	TC1, 2, OL0, UI	
	250 ²	1 - 30	---	2	1000	TC1, OL1, U2	TC3, OL1, U3					
		0.02 - 12	---			TC1, 2, OL1, UI	TC1, 2, OL1, UI					
	250	50 / 60	1	---	12.1 - 18	2	1000 ⁴	---	TC1, 2, OL0, C1	TC1, 2, OL0, C1		
0.02 - 15				---	TC1, 2, OL1, UI				TC1, 2, OL1, UI			
---				15.1 - 30	TC1, 2, OL0, UI	TC1, 2, OL0, UI						
1 - 30				---	360	TC1, OL1, U2			TC3, OL1, U3			

Notes:

- 1 Polarity Sensitive
- 2 Available only with Special Catalog Number. Consult Factory.
- 3 Requires Branch Circuit Backup with a UL Listed type K-5 or RK-5 fuse rated 30 Amps maximum
- 4 Requires Branch Circuit Backup with a UL Listed type K-5 or RK-5 fuse rated 60 Amps maximum

Table B: Lists UL Recognized, CSA Accepted and TUV and VDE Certified configurations and performance capabilities as a Component Supplementary Protector.

Component Supplementary Protectors												
Circuit Configuration	Voltage			Current Rating		Poles Breaking	Short Circuit Capacity (Amps)				Application Codes	
	Max Rating	Frequency	Phase	Full Load Amps	General Purpose Amps		UL / CSA		VDE / TUV		UL	CSA
							With Backup Fuse	Without Backup Fuse	With Backup Fuse	Without Backup Fuse		
Series	32	DC	---	0.02 - 15	---	1	---	1000	3000	500	TC1, 2, OL1, UI	TC1, 2, OL1, UI
				---	15.1 - 25						TC1, 2, OL0, UI	TC1, 2, OL0, UI
	50 ²			0.02 - 7.5	---	2					TC1, 2, OL0, UI	TC1, 2, OL0, UI
				65	0.02 - 15						---	TC1, 2, OL1, UI
	---				15.1 - 25	TC1, 2, OL0, UI					TC1, 2, OL0, UI	
	65 ³			0.02 - 15	---	1					TC1, 2, OL1, C1	TC1, 2, OL1, C1
		---	15.1 - 30	TC1, 2, OL0, C1	TC1, 2, OL0, C1							
	80 ¹	0.02 - 15	---	1	600 ⁴	---	TC1, 2, OL1, UI	TC1, 2, OL1, UI				
		---	15.1 - 30				TC1, 2, OL0, UI	TC1, 2, OL0, UI				
	125	50 / 60	1	0.02 - 15	---	2	1000	3000	TC1, 2, OL1, UI	TC1, 2, OL1, UI		
				1 - 15	---				TC1, OL1, U2	TC3, OL1, U3		
	250			0.02 - 12	---	1			360	TC1, 2, OL1, UI	TC1, 2, OL1, UI	
				0.02 - 20	---					TC1, 2, OL0, UI	TC1, 2, OL0, UI	
	250			1 - 12	---	1			360	TC1, OL1, U2	TC3, OL1, U3	

Notes:

- 1 Polarity Sensitive
- 2 Available only with Special Catalog Number. Consult Factory.
- 3 Requires Branch Circuit Backup with a UL Listed type K-5 or RK-5 fuse rated 30 Amps maximum
- 4 TUV only, not VDE
- 5 Requires backup protection with a thermal magnetic circuit breaker rated 32 amps and having a Type C trip characteristic per EN60898/DIN VDE 0641 (C32A) for ratings greater than 15amps, and a thermal magnetic circuit breaker rated 16 amps and having a Type C trip characteristic per EN60898/DIN VDE 0641 (C16A) for ratings 15 amps and less

Tech Specs

Tables

Table C: Lists UL489A Listed and TUV Certified configurations and performance capabilities for use in Communications Equipment.

UL489A Listed (Communications Equipment - Polarity Sensitive)						
Circuit Configuration	Voltage		Current Rating General Purpose Amps	Poles Breaking	Interrupting Capacity (Amps)	
	Max Rating	Frequency			Without Backup Fuse	
					UL489A	TUV
Series	80	DC	0.02 - 30	1	600	---
	65 ¹				1000	---
	80		0.10 - 30		600	600

Notes:
1. Available only with Special Catalog Number

Table D: Lists UL489A Listed configurations and performance capabilities for use in Communications Equipment.

Parallel Pole Construction UL489A Listed (Communications Equipment - Polarity Sensitive)						
Circuit Configuration	Voltage		Current Rating General Purpose Amps	Poles Breaking	Interrupting Capacity (Amps)	
	Max Rating	Frequency			Without Backup Fuse	
					UL489A	
Series	80	DC	31 - 50	2	600	
	65 ¹				1000	

Notes:
1. Available only with Special Catalog Number

Agency Approvals

UL 1077

Component Recognition Program as Protectors, Supplementary (Guide CCN/QVNU2, File E75596)

UL 489A

Communications Equipment (Guide CCN/DITT, File E189195)

CSA Accepted

Component Supplementary Protector (Class 3215 30, File 047848 0 000) CSA Standard C22.2 No. 235

VDE Certified

EN60934, VDE 0642 under File 10537

TUV Certified

EN60934, under License No. R9671109

Time Delay Specs

To view all hydraulic-magnetic circuit breaker time delay values, please visit www.carlingtech.com/sites/default/files/documents/Carling-HM-CB-Time-Delays.pdf

Ordering Scheme Rocker – Parallel Pole

Sample Part Number

M E 2 - P - D2 - 650 - 5 - A 1 2 - B - T

Selection 1 2 3 4 5 6 7 8 9 10 11 12

1. SERIES

M

2. ACTUATOR ¹

Single Color
A Angled
B Flat

Two Color Visi
D Indicate ON
E Indicate OFF

Single Color Translucent
F Angled
G Flat

STYLE	INDICATE - "ON" (CODE-D)	INDICATE - "OFF" (CODE-E)	FLAT (CODES-B&G)	ANGLED (CODES-A&F)
VERTICAL				
HORIZONTAL				

3. POLES

2 Two

4. CIRCUIT/ AUXILIARY SWITCH ²

P Series Trip Current (Parallel Pole)
with Auxiliary Switch, Silver Contacts

Q Series Trip Current (Parallel Pole) .110 x 0.20 Q.C

with Auxiliary Switch, Gold Contacts

R Series Trip Current (Parallel Pole) .110 x 0.20 Q.C

5. FREQUENCY & TIME DELAY

D2 DC Short
D4 DC Medium

6. CURRENT RATING (AMPERES)

CODE	AMPERES
631	31.000
635	35.000
640	40.000
645	45.000
650	50.000

7. TERMINAL

A Push in Stud
5 10-32 Screw (Bus Type)

8. ILLUMINATION

Non-Illuminated
A Non-Illuminated

9. ACTUATOR COLOR & LEGEND

Actuator Visi ¹	Legend
1 White	Black
2 Black	White
3 Red	White
4 Green	White
5 Blue	White
6 Yellow	Black
7 Gray	Black
8 Orange	Black

10. LEGEND

2 ON - OFF Vertical
3 ON - OFF Horizontal
6 Dual Vertical
7 Dual Horizontal

11. BEZEL COLOR

A White without Rockerguard
B Black without Rockerguard
G Gray without Rockerguard

1 White with Rockerguard
2 Black with Rockerguard
7 Gray with Rockerguard

12. AGENCY APPROVAL

T UL 489A Listed

Notes:

- ¹ Remainder of Rocker same color as Visi
² Aux Switch only available with screw terminals

[Configure Complete Part Number >](#)

[Browse Standard Parts >](#)

Ordering Scheme

Handle/Pushbutton – Parallel Pole

Sample Part Number M M 2 - P - D2 - 650 - 5 - 1 B B - B - T

Selection 1 2 3 4 5 6 7 8 9 10 11 12

1. SERIES

M

2. ACTUATOR ¹

M Paddle
T Push-Pull

3. POLES

2 Two

4. CIRCUIT/ AUXILIARY SWITCH ²

P Series Trip Current (Parallel Pole)
with Auxiliary Switch, Silver Contacts
Q Series Trip Current (Parallel Pole) .110 x 0.20 Q.C
with Auxiliary Switch, Gold Contacts
R Series Trip Current (Parallel Pole) .110 x 0.20 Q.C

5. FREQUENCY & TIME DELAY

D2 DC Short
D4 DC Medium

6. CURRENT RATING (AMPERES)

CODE	AMPERES
631	31.000
635	35.000
640	40.000
645	45.000
650	50.000

7. TERMINAL

A Push in Stud
5 10-32 Screw (Bus Type)

8. ACTUATOR COLOR & LEGEND

Handle	Push Button
1 White	A White
2 Black	B Black
3 Red	C Red
4 Green	D Green
5 Blue	E Blue
6 Yellow	F Yellow
7 Gray	G Gray
8 Orange	H Orange

9. FRONT PANEL HARDWARE

Handle

A No outer Panel Hardware
B Knurled Nut, Bright Nickel
C Knurled Nut, Bright Nickel with Locking Ring
D Knurled Nut, Black
E Knurled Nut, Black with Locking Ring
F Panel Dress, Bright Nickel
G Panel Dress, Bright Nickel with Locking Ring
H Panel Dress, Black
J Panel Dress, Black with Locking Ring

Push Button

1 No outer Panel Hardware
2 Knurled Nut, Bright Nickel

10. LEGEND PLATE / BUTTON MARKING

Handle Actuator Legend Plate

B ON - OFF Vertical
C ON - OFF Horizontal

Push-Pull Actuator Legend Plate

2 Rated Amps Horizontal
3 Rated Amps Line Side Down
4 Rated Amps Line Side Up

11. BUSHING COLOR

B Black

12. AGENCY APPROVAL

T UL 489A Listed

Notes:

1 Remainder of Rocker same color as Visi
2 Aux Switch only available with screw terminals

[Configure Complete Part Number >](#)

[Browse Standard Parts >](#)

Dimensional Specs Parallel Pole

inches [millimeters]

PARALLEL POLE TERMINAL OPTIONS

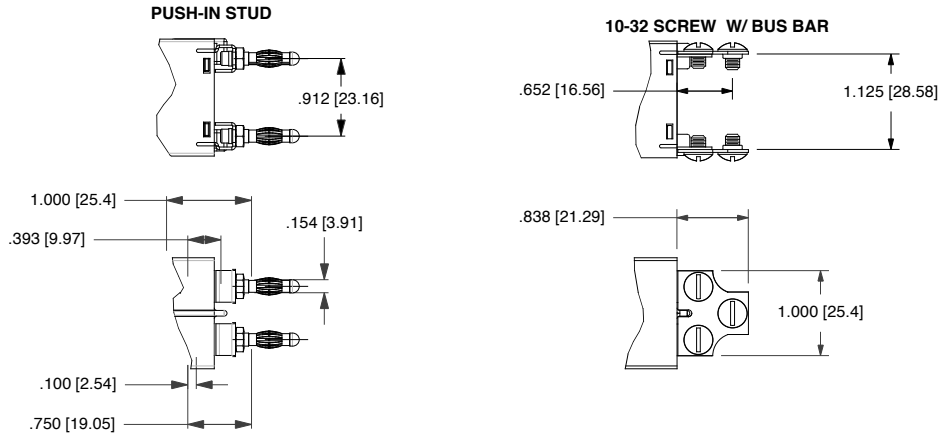

ROCKER ACTUATOR DETAIL

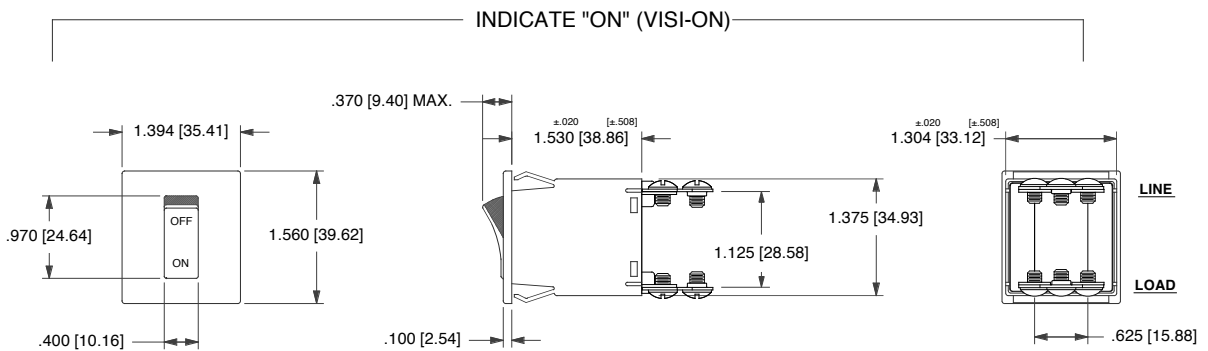

INDICATE "OFF" (VISI-OFF) & SINGLE COLOR

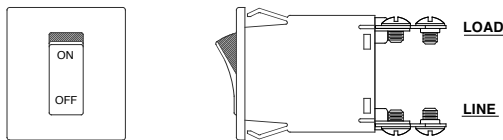

ROCKERGUARD CONFIGURATION

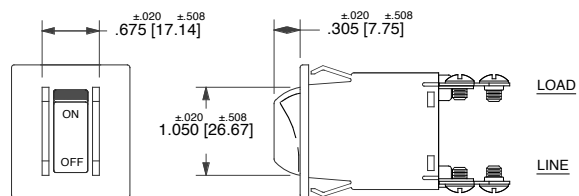

PANEL CUT - OUT DETAIL (ROCKER)

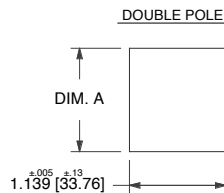

PANEL THICKNESS	DIM. A
.062 [1.57]	1.385 [35.18]
.093 [2.36]	1.420 [36.07]
.125 [3.18]	1.460 [37.08]

- Notes:
- 1 Tolerance ± 0.10 [25] unless otherwise specified.
 - 2 Dimensions apply to both rocker styles.
 - 3 I-o, on-off or dual legends available for vertical or horizontal mounting.
 - 4 Notice that circuit breaker line and load terminal orientation on indicate "off" is opposite that of indicate "on".

Dimensional Specs Parallel Pole

inches [millimeters]

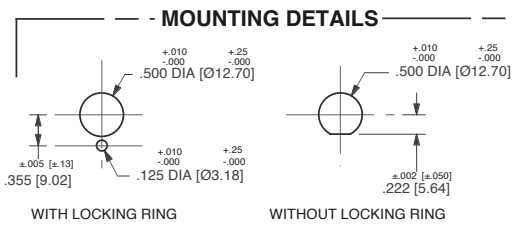
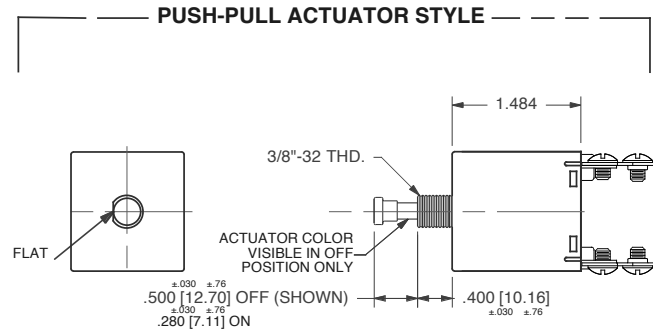
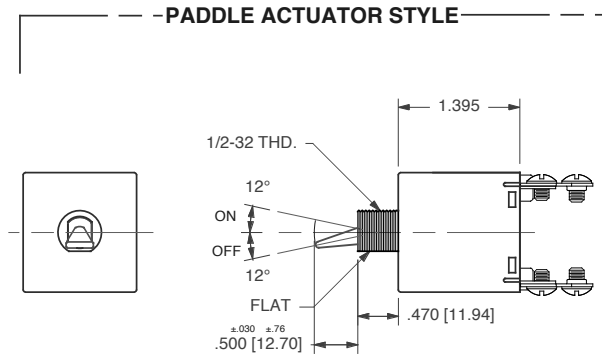

MOUNTING DETAILS

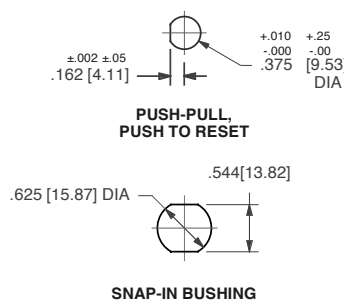

PANEL HARDWARE

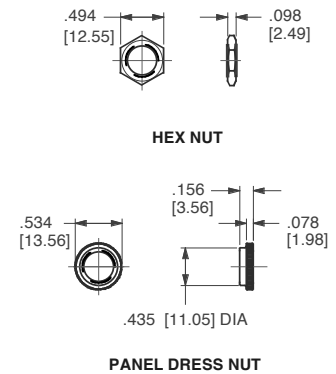

LEGEND PLATES

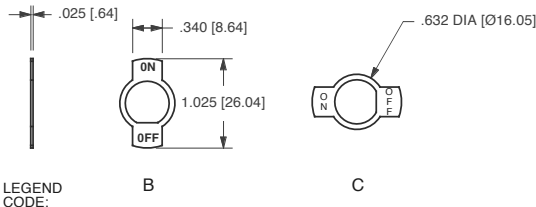

LEGEND CODE:

PANEL HARDWARE

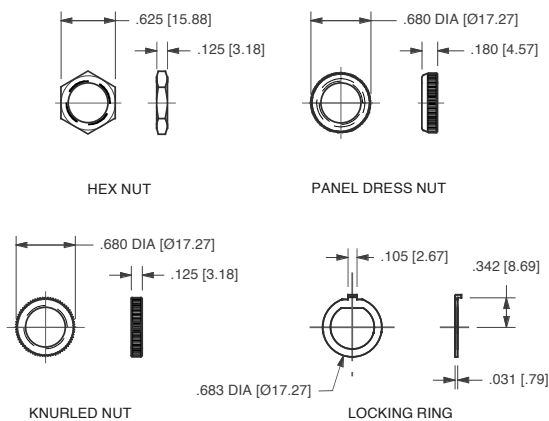

BUTTON MARKING ORIENTATION

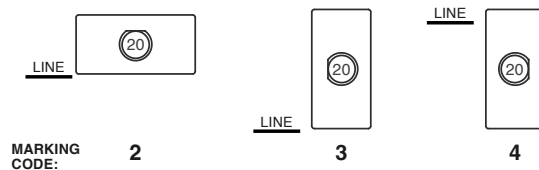

.110QC AUXILIARY SWITCH TERMINALS

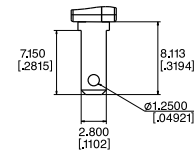

Notes:

- 1 Tolerance ± 0.010 [25] unless otherwise specified.
- 2 Dimensions apply to both rocker styles.
- 3 I-o, on-off or dual legends available for vertical or horizontal mounting.
- 4 Notice that circuit breaker line and load terminal orientation on indicate "off" is opposite that of indicate "on".

Ordering Scheme

Rocker - UL 1077 Recognized

Sample Part Number **M G 2 - B - 34 - 620 - 1 - H C 6 - 7 - C**

Selection 1 2 3 4 5 6 7 8 9 10 11 12

1. SERIES

M

2. ACTUATOR 1

Non-Illuminated single color
A Angled
B Flat

Two Color Visi-Rocker
D Indicate ON
E Indicate OFF

Illuminated single color
F Angled
G Flat

STYLE	INDICATE - "ON" (CODE-D)		INDICATE - "OFF" (CODE-E)	
	FLAT (CODES-B&G)	ANGLED (CODES-A&F)	FLAT (CODES-B&G)	ANGLED (CODES-A&F)
VERTICAL				
HORIZONTAL				

3. POLES

1 One 2 Two

4. CIRCUIT 2

without Auxiliary Switch
A Switch Only (no coil), Maintained Contacts
B Series Trip (Current)

with Auxiliary Switch, Silver Contacts
M Series Trip (Current) Aux Switch .110 QC x .020 QC
P 3 Switch Only, Maintained Contacts .080 Dia, Round Solder Turret
R 3,15 Switch Only, Maintained Contacts .080 Dia x .020 Flat Q.C.
S 3 Series Trip (Current) .060 Dia, Round Solder Turret
U 3,15 Series Trip, Maintained Contacts .080 Dia x .020 Flat Q.C.

with Auxiliary Switch, Gold Contacts
3 3,15 Switch Only, Maintained Contacts .080 Dia x .020 Flat Q.C.
5 3,15 Series Trip, Maintained Contacts .080 Dia x .020 Flat Q.C.
9 Series Trip (Current) Aux Switch .110 QC x .020 QC

Terminal Type:
3 .080 Dia, Round Solder Turret
5 .060 Dia, Round Solder Turret
9 .080 Dia x .020 Flat Q.C.

5. FREQUENCY & TIME DELAY

03 DC 50/60Hz, Switch Only	32 11 DC, 50/60Hz Short
10 DC Instantaneous	34 11 DC, 50/60Hz Medium
12 DC Short	62 50/60Hz Short, High-inrush
14 DC Medium	64 50/60Hz Medium, High-inrush
20 50/60Hz Instantaneous	72 DC, Short, High-inrush
22 50/60Hz Short	74 DC, Medium, High-inrush
24 50/60Hz Medium	92 11 DC, 50/60Hz Short, High-inrush
30 11 DC, 50/60Hz Instantaneous	94 11 DC, 50/60Hz Medium, High-inrush

Voltage			Full Load Amp Rating		General Purpose Amps		Tungsten Lamp Rating		Poles Breaking
Max Rating	Frequency	Phase	Max Amps	Current Coil Rating Code	Max Amps	Choose Current Coil Rating Code	Max Amps	Current Coil Rating Code	
32	DC	-	15	615	25	625	-	-	1
50	DC	-	-	-	7.5	Consult Factory	-	-	1
65	DC	1	15	615	25	625	-	-	2
125	50/60Hz	1	15	615	25	625	15	615	1
250	50/60Hz	1	12	612	-	-	-	-	1
250	50/60Hz	1	15	615	25	625	-	-	2

Notes:

- One actuator is located in the center of each multi-pole breaker.
- For Switch Only circuits, select Current Coil Rating from the above chart.
- One Auxiliary Switch is supplied per breaker. On two-pole breakers, standard Auxiliary Switch mounting is in pole one. Auxiliary Switch option limited to Series Trip & Switch Only circuits, & is not available in single pole illuminated breakers, or Back Connected Screw or Push-in Stud terminals.
- For neon bulb applications at 120VAC @ 47K, 1/4 WATT and for 250VAC applications @ 150K, 1/4 WATT, external resistors must be supplied by customer.
- On Visi-Rockers, Visi portion of rocker cannot be the same color as bezel.
- For LED (DC or rectified AC) applications, LED is mounted in the center of the rocker actuator with electrical characteristics: 100 millicandela at 20mA; Maximum power dissipation = 75mW at 25°C; Maximum forward current = 25mA; Typical forward voltage = 2.1V at 20mA; Typical reverse current = 100uA at 3V. Customer supplies the proper external resistor limiting current to these values.
- Rocker color for LED's and green neon lamp must be clear, smoke gray, white translucent or match color of LED or neon lamp.
- Other colors available. Consult factory.
- TUV 20A, VDE 15A, UL Recognized and CSA Accepted to 30 amps.
- Screw Terminals or Push-in Stud recommended above 20 amps.
- TUV/VDE must have I-O or Dual Legends. Legend required on Visi-Rockers.
- 30 amp rating not available with delay's 30, 32, 34, 92 or 94.
- Screw Terminals are VDE certified only with use of ring terminal attached to wire.
- Terminal code A available with circuit codes A & B only.
- Printed circuit board available with UL recognized approval only.
- Auxiliary switch (flat Q.C.) available with UL recognized approvals only.

6. CURRENT RATING (AMPERES)

CODE	AMPERES	225	0.250	420	2.000	710	10.500
020	0.020	230	0.300	522	2.250	611	11.000
025	0.025	235	0.350	425	2.500	711	11.500
030	0.030	240	0.400	527	2.750	612	12.000
035	0.035	245	0.450	430	3.000	712	12.500
040	0.040	250	0.500	435	3.500	613	13.000
045	0.045	255	0.550	440	4.000	614	14.000
050	0.050	260	0.600	445	4.500	615	15.000
055	0.055	265	0.650	450	5.000	616	16.000
060	0.060	270	0.700	455	5.500	617	17.000
065	0.065	275	0.750	460	6.000	618	18.000
070	0.070	280	0.800	465	6.500	620	20.000
075	0.075	285	0.850	470	7.000	622	22.000
080	0.080	290	0.900	475	7.500	624	24.000
085	0.085	295	0.950	480	8.000	625	25.000
090	0.090	410	1.000	485	8.500	630	30.000
095	0.095	512	1.250	490	9.000		
210	0.100	415	1.500	495	9.500		
215	0.150	517	1.750	610	10.000		
220	0.200						

7. TERMINAL 12

1 Push-On 0.250 Tab (Q.C.)
 2 Screw 8-32 with Upturned Lugs⁹

3 Screw 8-32 (Bus Type)⁹
 A Push-In Stud¹³
 P Printed Circuit Board¹⁴

8. ROCKER ILLUMINATION

Non-illuminated
Neon⁴
 without resistor, 120VAC/250VAC
LED^{6,7}
 without resistor
 with resistor, 4-8 VDC
 with resistor, 9-16 VDC

A Neon Green Glow⁷
B Red Green Amber
D Gray
E Orange
F White Translucent

9. ACTUATOR & LEGEND COLOR

Solid Color

1 White	Actuator	Legend
2 Black	White	Black
3 Red	Black	White
4 Green	Red	White
5 Blue	Green	White
6 Yellow	Blue	White
7 Gray	Yellow	Black
8 Orange	Gray	Black

Visi-Rocker⁵
 Visi & Legend (remainder of rocker same color as bezel)

1 White	Actuator	Legend
2 Black	Clear	White
3 Red	Red Transparent	White
4 Green	Green Transparent	White
5 Blue	Amber Transparent	White
6 Yellow	Smoke Gray Transparent	White
7 Gray	White Translucent	Black

10. LEGEND 10

1 No Legend
 2 ON - OFF Vertical
 3 ON - OFF Horizontal
 4 I - O Vertical

5 I - O Horizontal
 6 Dual Vertical
 7 Dual Horizontal

11. BEZEL COLOR/STYLE 5,8

Color	without Rockerguard	with Rockerguard
White	A	1
Black	B	2
Gray	G	7

12. AGENCY APPROVAL 9,10

C UL 1077 Recognized & CSA Accepted
D VDE Certified to IEC/EN 60934, UL Recognized & CSA Accepted
E TUV Certified to IEC/EN 60934, UL Recognized & CSA Accepted

Configure Complete Part Number >

Browse Standard Parts >

Ordering Scheme

Rocker - UL 489A Listed & 1077 Recognized

Sample Part Number **M A 1 - B - 14 - 620 - 1 - A 1 6 - 2 - J**

Selection 1 2 3 4 5 6 7 8 9 10 11 12

1. SERIES

M

2. ACTUATOR 1

Non-Illuminated single color		Two Color Visi-Rocker		Illuminated single color
A Angled		D Indicate ON		F Angled
B Flat		E Indicate OFF		G Flat
STYLE	INDICATE - "ON" (CODE-D)	INDICATE - "OFF" (CODE-E)	FLAT (CODES-B&G)	ANGLED (CODES-A&F)
VERTICAL				
HORIZONTAL				

3. POLES

1 One

4. CIRCUIT 2

without Auxiliary Switch		
B Series Trip (Current)		
with Auxiliary Switch, Silver Contacts		Terminal Type:
M Series Trip (Current) Aux Switch		.110 QC x .020 QC
S 3 Series Trip (Current)		.060 Dia, Round Solder Turret
U 3,13 Series Trip, Maintained Contacts		.080 Dia x .020 Flat Q.C.
with Auxiliary Switch, Gold Contacts		
5 3,13 Series Trip, Maintained Contacts		.080 Dia x .020 Flat Q.C.
9 Series Trip (Current) Aux Switch		.110 QC x .020 QC

5. FREQUENCY & TIME DELAY

10 DC Instantaneous	72 DC, Short, High-inrush
12 DC Short	74 DC, Medium, High-inrush
14 DC Medium	

6. CURRENT RATING (AMPERES)

CODE	AMPERES						
020	0.020	225	0.250	420	2.000	710	10.500
025	0.025	230	0.300	522	2.250	611	11.000
030	0.030	235	0.350	425	2.500	711	11.500
035	0.035	240	0.400	527	2.750	612	12.000
040	0.040	245	0.450	430	3.000	712	12.500
045	0.045	250	0.500	435	3.500	613	13.000
050	0.050	255	0.550	440	4.000	614	14.000
055	0.055	260	0.600	445	4.500	615	15.000
060	0.060	265	0.650	450	5.000	616	16.000
065	0.065	270	0.700	455	5.500	617	17.000
070	0.070	275	0.750	460	6.000	618	18.000
075	0.075	280	0.800	465	6.500	620	20.000
080	0.080	285	0.850	470	7.000	622	22.000
085	0.085	290	0.900	475	7.500	624	24.000
090	0.090	295	0.950	480	8.000	625	25.000
095	0.095	410	1.000	485	8.500	630	30.000
210	0.100	512	1.250	490	9.000		
215	0.150	415	1.500	495	9.500		
220	0.200	517	1.750	610	10.000		

7. TERMINAL

1 Push-On 0.250 Tab (Q.C.)	3 Screw 8-32 (Bus Type) 9
2 Screw 8-32 with Upturned Lugs 9	A Push-In Stud 11
	P Printed Circuit Board 12

8. ROCKER ILLUMINATION

Non-illuminated Neon 4	A Green Glow 7
without resistor, 120VAC/250VAC	B C
LED 5,7	Red Green Amber
without resistor	D G K
with resistor, 4-8 VDC	E H L
with resistor, 9-16 VDC	F J M

9. ACTUATOR & LEGEND COLOR

Solid Color	Actuator	Legend
1	White	Black
2	Black	White
3	Red	White
4	Green	White
5	Blue	White
6	Yellow	Black
7	Gray	Black
8	Orange	Black
Visi-Rocker 6	Visi & Legend (remainder of rocker same color as bezel)	
1	White	
2	Black	
3	Red	
4	Green	
5	Blue	
6	Yellow	
7	Gray	
8	Orange	
Illuminated 7	Actuator	Legend
A	Clear	White
B	Red Transparent	White
C	Green Transparent	White
D	Amber Transparent	White
E	Smoke Gray Transparent	White
F	White Translucent	Black

10. LEGEND 10

1 No Legend	5 I - O Horizontal
2 ON - OFF Vertical	6 Dual Vertical
3 ON - OFF Horizontal	7 Dual Horizontal
4 I - O Vertical	

11. BEZEL COLOR/STYLE 6,8

Color	without Rockerguard	with Rockerguard
White	A	1
Black	B	2
Gray	G	7

12. AGENCY APPROVAL 9,10

J UL 489A Listed & TUV Certified to IEC/EN 60934
M UL 1077 Recognized & CSA Accepted
N TUV Certified to IEC/EN 60934, UL Recognized & CSA Accepted
T UL 489A Listed

Notes:

- One actuator is located in the center of each multi-pole breaker.
- For Switch Only circuits, select Current Coil Rating from the above chart.
- One Auxiliary Switch is supplied per breaker. On two-pole breakers, standard Auxiliary Switch mounting is in pole one. Auxiliary Switch option limited to Series Trip & Switch Only circuits, & is not available in single pole illuminated breakers, or Back Connected Screw or Push-In Stud terminals.
- For neon bulb applications at 120VAC @ 47K, 1/4 WATT and for 250VAC applications @ 150K, 1/4 WATT, external resistors must be supplied by customer.
- For LED (DC or rectified AC) applications, LED is mounted in the center of the rocker actuator with electrical characteristics as follows: 100 millicandela at 20mA; Maximum power dissipation = 75mW at 25°C; Maximum forward current = 25mA; Typical forward voltage = 2.1V at 20mA; Typical reverse current = 100uA at 3V. Customer supplies the proper external resistor limiting current to these values.
- On Visi-Rocker breakers, Visi portion of rocker cannot be the same color as the bezel.
- Rocker color for LED's and green neon lamp must be clear, smoke gray, white translucent or match color of LED or neon lamp.
- Other colors available. Consult factory.
- UL Recognized, CSA Accepted, UL489A Listed, and TUV Certified to 30 amps. Screw Terminals recommended above 20 amps.
- Polarity Sensitive Construction
- UL489A Listed must have ON-OFF or Dual legends. TUV Certified approvals must have I - O or Dual legends.
- Terminal code A available with circuit codes A & B only.
- Printed circuit board available with UL recognized approval only.
- Auxiliary switch (flat Q.C.) available with UL recognized approvals only.

[Configure Complete Part Number >](#)

[Browse Standard Parts >](#)

Circuit & Terminal Diagrams Rocker

inches [millimeters]

SERIES TRIP

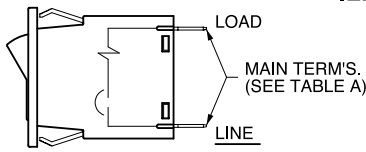

SERIES TRIP W/ ILLUMINATED ROCKER

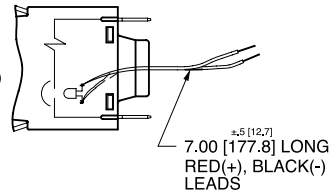

SWITCH ONLY

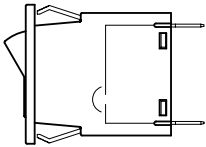

SWITCH ONLY W/ ILLUMINATED ROCKER

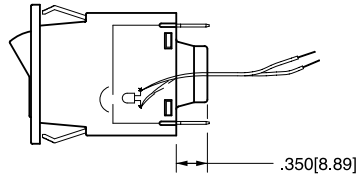

SERIES TRIP W/ AUXILIARY SWITCH

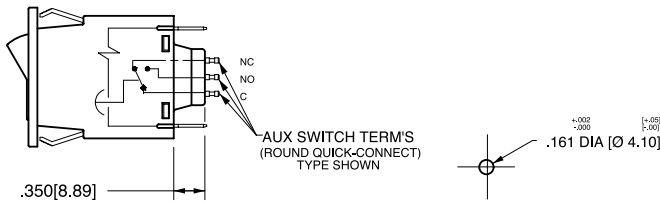

PUSH-IN STUD MATING HOLE

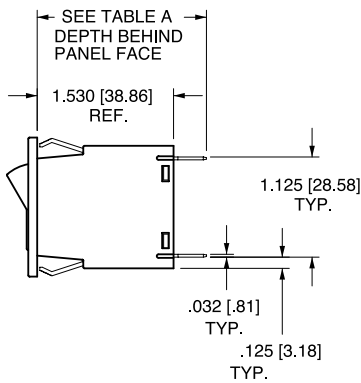

TERMINAL DIMENSIONAL DETAIL

TAB (Q.C.) TERMINAL

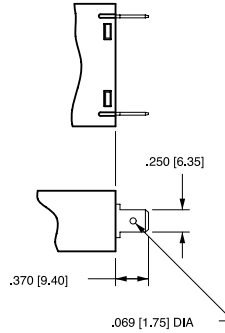

SCREW TERMINAL #8-32 WITH UPTURNED LUGS

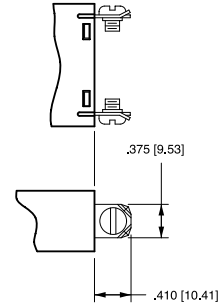

SCREW TERMINAL #8-32 BUS

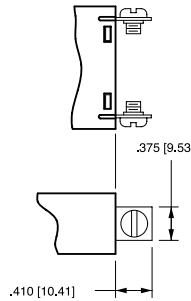

PUSH-IN STUD TERMINAL

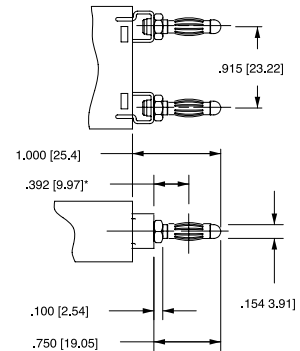

*CENTERLINE OF PUSH-IN STUD CONTACT AREA

AUXILIARY SWITCH TERMINALS

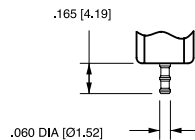

DOUBLE SOLDER TURRET TYPE

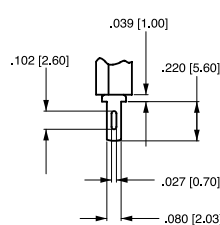

.080 [2.03] X .020 [.51] FLAT QUICK-CONNECT TYPE

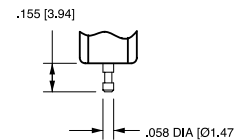

ROUND QUICK-CONNECT TYPE

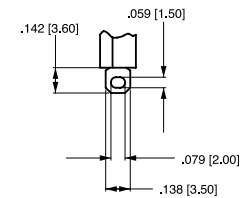

FLAT SOLDER LUG TYPE

*AVAILABLE THROUGH SPECIAL CATALOG PART NUMBER

.110 QC

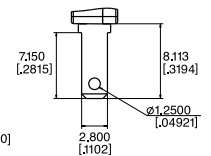

TABLE - A		
TERMINAL DESCRIPTION		DEPTH BEHIND PANEL FACE
MAIN	TAB (Q.C.)	1.900 [48.26]
	SCREW (#8-32)**	1.940 [49.28]
	PUSH-IN STUD	2.530 [64.26]
*AUX. SWITCH	DOUBLE SOLDER TURRET TYPE	2.045 [51.94]
	ROUND Q.C. TYPE	2.035 [51.69]
	FLAT QUICK CONNECT	2.139 [54.33]
	FLAT SOLDER LUG	2.022 [51.36]

* AUX. SWITCH IS NOT AVAILABLE ON SINGLE POLE ILLUMINATED UNITS. WHEN CALLED FOR ON MULTI-POLE UNITS, ONLY ONE AUX. SWITCH IS NORMALLY SUPPLIED, MOUNTED AS SHOWN ON CLA-8003.

** RECOMMENDED TIGHTENING TORQUE 12-15 IN LBS [1.4-2.7 NM]

Notes:

- 1 Tolerance ± 0.020 [.51] unless otherwise specified.
- 2 Schematic shown represents current trip circuit.

Dimensional Specs Rocker

inches [millimeters]

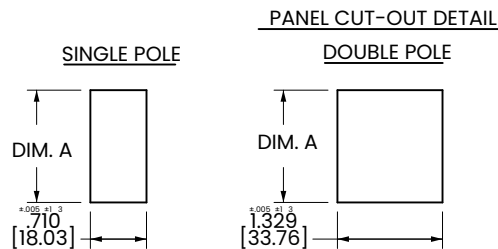
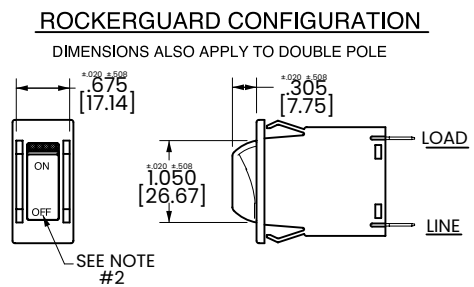
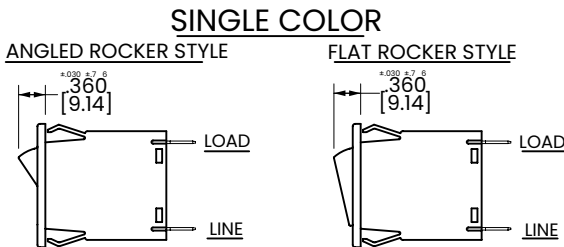
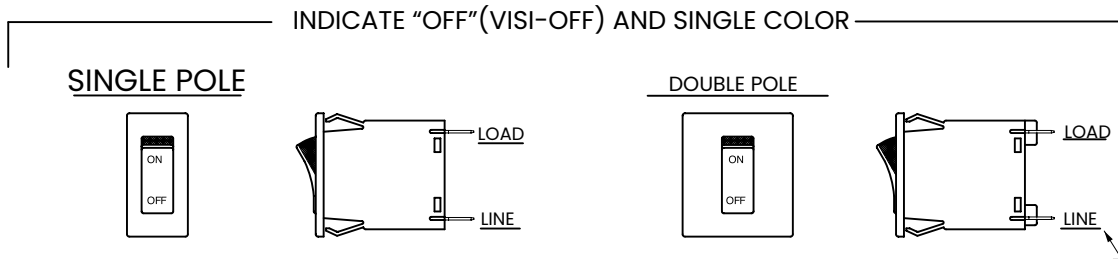
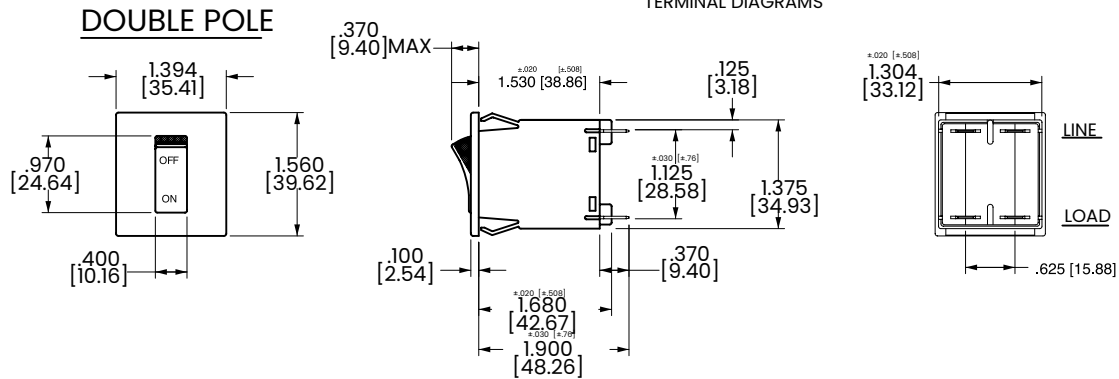
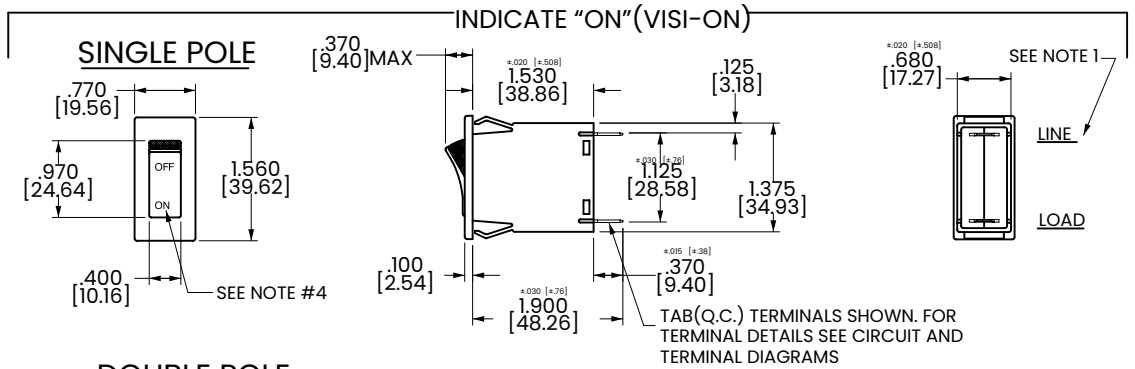

PANEL THICKNESS	DIM. A <small>+0.05 / +0.13 +0.00 / -0.0</small>
.062 [1.57]	1.385 [35.18]
.093 [2.36]	1.420 [36.07]
.125 [3.18]	1.460 [37.08]

Notes:

- 1 Dimensions apply to all variations shown. Notice that circuit breaker line & load terminal orientation on indicate OFF is opposite of indicate ON.
- 2 I-O, ON-OFF or dual legends available for vertical or horizontal mounting. For pole orientation with horizontal legend, rotate front view clockwise 90°.
- 3 Tolerance ± 0.20 [.51] unless otherwise specified.

Supplementary Diagrams Rocker

ONE POLE

SINGLE POLE/ROCKER BREAKERS SHOWN WITH DOUBLE SOLDER TURRET AND ROUND QC AUX.SWITCH TERMINALS

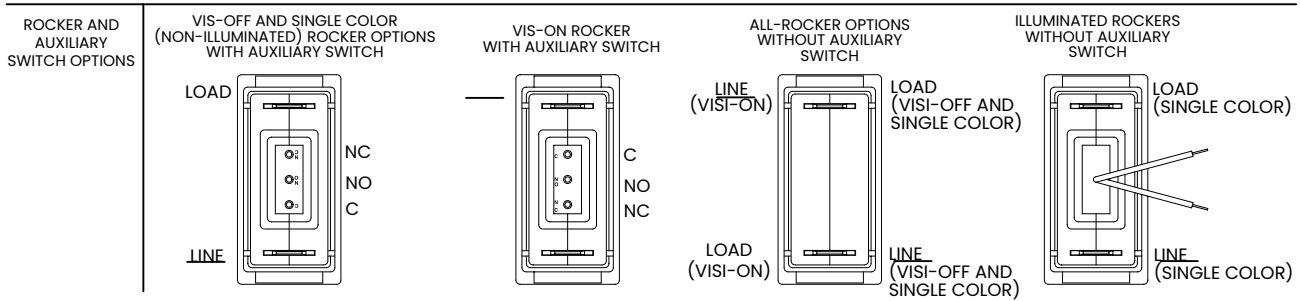

SINGLE POLE/ROCKER BREAKERS SHOWN WITH FLAT QC AND FLAT SOLDER LUG AUX.SWITCH TERMINALS

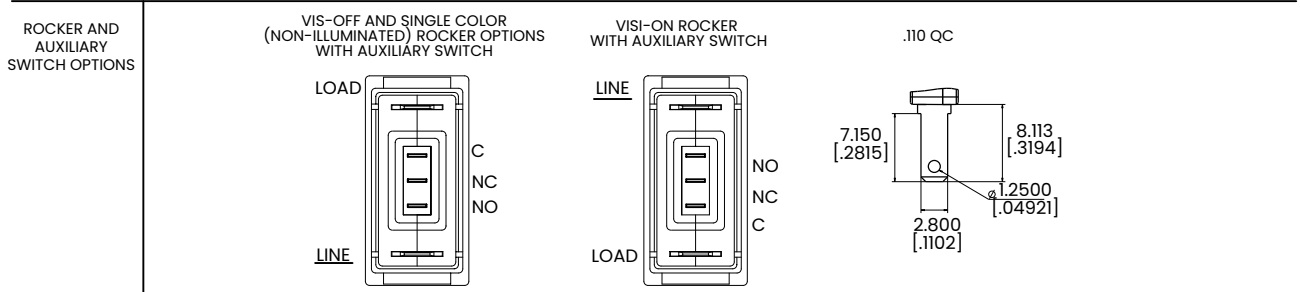

TWO POLE

DOUBLE POLE/ROCKER BREAKERS SHOWN WITH DOUBLE SOLDER TURRET AND ROUND QC AUX.SWITCH TERMINALS

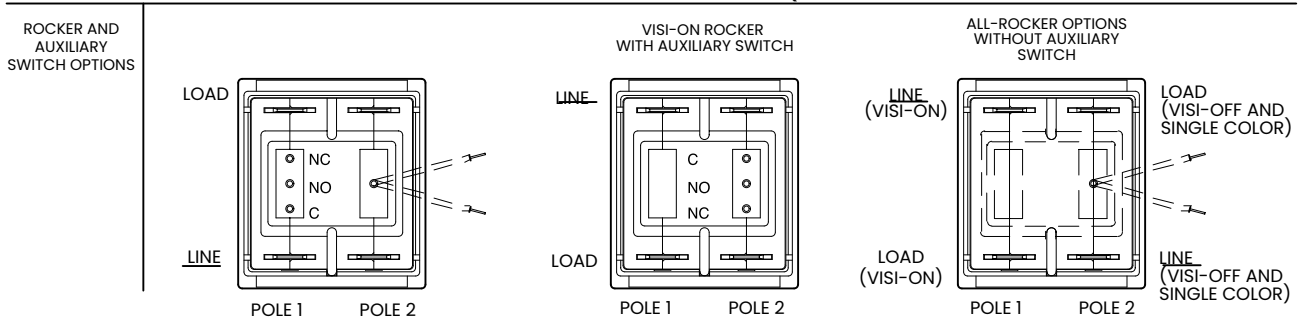

DOUBLE POLE/ROCKER BREAKERS SHOWN WITH FLAT QC AND FLAT SOLDER LUG AUX.SWITCH TERMINALS

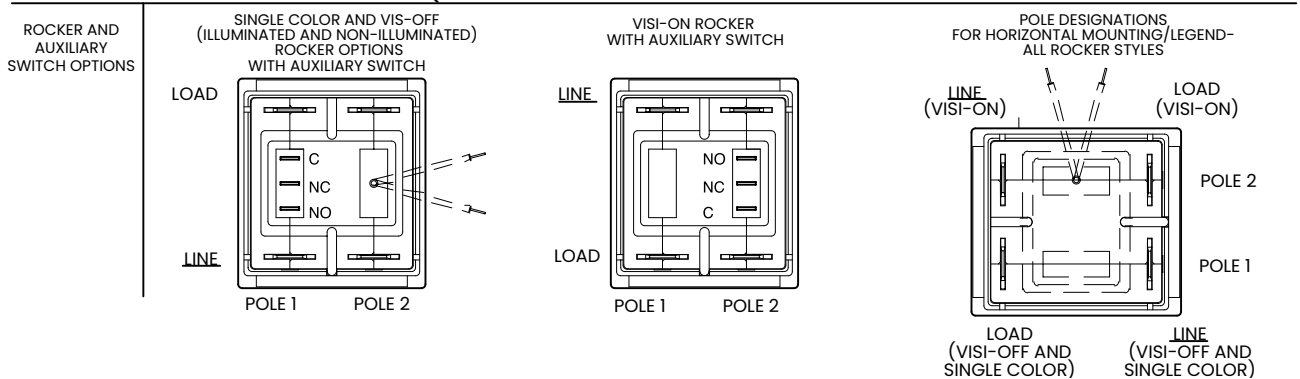

Ordering Scheme

Handle/Pushbutton - UL 1077 Recognized



Sample Part Number **M M 1 - B - 34 - 260 - 1 - 1 B B - C - B**



Selection 1 2 3 4 5 6 7 8 9 10 11 12



1. SERIES

M

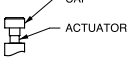
2. ACTUATOR 1,4

Handle
M Paddle  **N** Baton 

Push Button
T Push-Pull  **U** Push To Reset 

Push Button with Snap-In Mounting
V Push-Pull  **W** Push To Reset 

3. POLES

1 One 2 Two

4. CIRCUIT 2

without Auxiliary Switch
A Switch Only (no coil), Maintained Contacts
B Series Trip (Current)

with Auxiliary Switch, Silver Contacts **Terminal Type:**
M Series Trip (Current) Aux Switch .110 QC x .020 QC
P 3 Switch Only, Maintained Contacts .060 Dia, Round Solder Turret
R 3,12 Switch Only, Maintained Contacts .080 Dia x .020 Flat Q.C.
S 3 Series Trip (Current) .060 Dia, Round Solder Turret
U 3,12 Series Trip, Maintained Contacts .080 Dia x .020 Flat Q.C.

with Auxiliary Switch, Gold Contacts
3 3,12 Switch Only, Maintained Contacts .080 Dia x .020 Flat Q.C.
5 3,12 Series Trip, Maintained Contacts .080 Dia x .020 Flat Q.C.
9 Series Trip (Current) Aux Switch .110 QC x .020 QC

5. FREQUENCY & TIME DELAY

03 DC 50/60Hz, Switch Only	32 ⁸ DC, 50/60Hz Short
10 DC Instantaneous	34 ⁸ DC, 50/60Hz Medium
12 DC Short	62 50/60Hz Short, High-inrush
14 DC Medium	64 50/60Hz Medium, High-inrush
20 50/60Hz Instantaneous	72 DC, Short, High-inrush
22 50/60Hz Short	74 DC, Medium, High-inrush
24 50/60Hz Medium	92 ⁸ DC, 50/60Hz Short, High-inrush
30 ⁸ DC, 50/60Hz Instantaneous	94 ⁸ DC, 50/60Hz Medium, High-inrush

Voltage			Full Load Amp Rating		General Purpose Amps		Tungsten Lamp Rating		Poles Breaking
Max Rating	Frequency	Phase	Max Amps	Current Coil Rating Code	Max Amps	Choose Current Coil Rating Code	Max Amps	Current Coil Rating Code	
32	DC	-	15	615	25	625	-	-	1
50	DC	-	-	-	7.5	Consult Factory	-	-	1
65	DC	1	15	615	25	625	-	-	2
125	50/60Hz	1	15	615	25	625	15	615	1
250	50/60Hz	1	12	612	-	-	-	-	1
250	50/60Hz	1	15	615	25	625	-	-	2

Notes:

- One actuator is located in the center of each multi-pole breaker. Actuator codes V & W limited to single pole breakers only.
- Switch Only circuits are not available with Push-To-Reset actuators. For Switch Only circuits, select Current Coil Rating from the above chart.
- One Auxiliary Switch is supplied per breaker. On two-pole breakers, standard Auxiliary Switch mounting is in pole one. Auxiliary Switch option limited to Series Trip and Switch Only circuits. Not available with back connect screw or push-in stud terminals.
- Actuator color is only visible in the OFF position on Push-Pull actuators.
- All units except snap-in mounting have one hex nut installed on bushing for use behind the panel.
- Other colors available. Consult factory.
- TUV 20A, VDE 15A. UL Recognized and CSA Accepted to 30 amps. Screw Terminals or Push-in Stud recommended above 20 amps.
- 30 amp rating not available with delay's 30, 32, 34, 92 or 94.
- Screw Terminals are VDE certified only with use of ring terminal attached to wire.
- Terminal code A available with circuit codes A & B only.
- Printed circuit board available with UL recognized approval only.
- Auxiliary switch (flat Q.C.) available with UL recognized approvals only.

6. CURRENT RATING (AMPERES)

CODE	AMPERES						
020	0.020	225	0.250	420	2.000	710	10.500
025	0.025	230	0.300	522	2.250	611	11.000
030	0.030	235	0.350	425	2.500	711	11.500
035	0.035	240	0.400	527	2.750	612	12.000
040	0.040	245	0.450	430	3.000	712	12.500
045	0.045	250	0.500	435	3.500	613	13.000
050	0.050	255	0.550	440	4.000	614	14.000
055	0.055	260	0.600	445	4.500	615	15.000
060	0.060	265	0.650	450	5.000	616	16.000
065	0.065	270	0.700	455	5.500	617	17.000
070	0.070	275	0.750	460	6.000	618	18.000
075	0.075	280	0.800	465	6.500	620	20.000
080	0.080	285	0.850	470	7.000	622	22.000
085	0.085	290	0.900	475	7.500	624	24.000
090	0.090	295	0.950	480	8.000	625	25.000
095	0.095	410	1.000	485	8.500	630 ⁸	30.000
210	0.100	512	1.250	490	9.000		
215	0.150	415	1.500	495	9.500		
220	0.200	517	1.750	610	10.000		

7. TERMINAL 9

1 Push-On 0.250 Tab (Q.C.)	3 Screw 8-32 (Bus Type) ⁷
2 Screw 8-32 with Upturned Lugs ⁷	A Push-In Stud ¹⁰
	P Printed Circuit Board ¹¹

8. ROCKER ILLUMINATION

Gloss Handle	Push-Button	Actuator Color
1	A	White
2	B	Black
3	C	Red
4	D	Green
5	E	Blue
6	F	Yellow
8	H	Orange

9. ACTUATOR & LEGEND COLOR 4,5

	Handle	Push-Button
No outer Panel Hardware	A	1
Knurled Nut		
Bright nickel	B	2
Bright nickel with locking ring	C	
Black	D	
Black with locking ring	E	
Panel Dress Nut		
Bright nickel	F	
Bright nickel with locking ring	G	
Black	H	
Black with locking ring	J	

10. LEGEND

Handle Actuator Legend Plate (Actuator Styles M & N)
A No Legend Plate
B ON - OFF Vertical
C ON - OFF Horizontal
D I - O Vertical
E I - O Horizontal

Push-Pull Actuator Button Cap (Actuator Styles T & V)
1 No Marking
2 Rated Amps Horizontal
3 Rated Amps Line Side Down
4 Rated Amps Line Side Up

Push-to-Reset Actuator Button (Actuator Styles U & W)
1 No Marking

11. BUSHING COLOR 6

B Black

12. AGENCY APPROVAL 7

C	UL 1077 Recognized & CSA Accepted
D	VDE Certified to IEC/EN 60934, UL Recognized & CSA Accepted
E	TUV Certified to IEC/EN 60934, UL Recognized & CSA Accepted

Ordering Scheme

Handle/Pushbutton - UL 489A Listed & 1077 Recognized







Sample Part Number **M M 1 - B - 14 - 620 - 1 - 1 B B - B - J**

Selection 1 2 3 4 5 6 7 8 9 10 11 12

1. SERIES

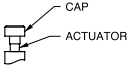
M

2. ACTUATOR 1,5

Handle M Paddle 	N Baton 
Push Button T Push-Pull 	U Push To Reset 
Push Button with Snap-In Mounting V Push-Pull 	W Push To Reset 

3. POLES

1 One

4. CIRCUIT 2

without Auxiliary Switch B Series Trip (Current)	Terminal Type: .110 QC x .020 QC
with Auxiliary Switch, Silver Contacts M Series Trip (Current) Aux Switch	.060 Dia, Round Solder Turret
S ³ Series Trip (Current)	.080 Dia x .020 Flat Q.C.
U ^{3,11} Series Trip, Maintained Contacts	.080 Dia x .020 Flat Q.C.
with Auxiliary Switch, Gold Contacts 5 ^{3,11} Series Trip, Maintained Contacts	.080 Dia x .020 Flat Q.C.
9 Series Trip (Current) Aux Switch	.110 QC x .020 QC

5. FREQUENCY & TIME DELAY

03 DC 50/60Hz, Switch Only	32 DC, 50/60Hz Short
10 DC Instantaneous	34 DC, 50/60Hz Medium
12 DC Short	62 50/60Hz Short, High-inrush
14 DC Medium	64 50/60Hz Medium, High-inrush
20 50/60Hz Instantaneous	72 DC, Short, High-inrush
22 50/60Hz Short	74 DC, Medium, High-inrush
24 50/60Hz Medium	92 DC, 50/60Hz Short, High-inrush
30 DC, 50/60Hz Instantaneous	94 DC, 50/60Hz Medium, High-inrush

6. CURRENT RATING (AMPERES)

CODE	AMPERES						
020	0.020	225	0.250	420	2.000	710	10.500
025	0.025	230	0.300	522	2.250	611	11.000
030	0.030	235	0.350	425	2.500	711	11.500
035	0.035	240	0.400	527	2.750	612	12.000
040	0.040	245	0.450	430	3.000	712	12.500
045	0.045	250	0.500	435	3.500	613	13.000
050	0.050	255	0.550	440	4.000	614	14.000
055	0.055	260	0.600	445	4.500	615	15.000
060	0.060	265	0.650	450	5.000	616	16.000
065	0.065	270	0.700	455	5.500	617	17.000
070	0.070	275	0.750	460	6.000	618	18.000
075	0.075	280	0.800	465	6.500	620	20.000
080	0.080	285	0.850	470	7.000	622	22.000
085	0.085	290	0.900	475	7.500	624	24.000
090	0.090	295	0.950	480	8.000	625	25.000
095	0.095	410	1.000	485	8.500	630	30.000
210	0.100	512	1.250	490	9.000		
215	0.150	415	1.500	495	9.500		
220	0.200	517	1.750	610	10.000		

7. TERMINAL

1 Push-On 0.250 Tab (Q.C.)	3 Screw 8-32 (Bus Type) ⁴
2 Screw 8-32 with Upturned Lugs ⁴	A Push-in Stud ⁹
	P Printed Circuit Board ¹⁰

8. ROCKER ILLUMINATION

Gloss Handle	Push-Button	Actuator Color
1	A	White
2	B	Black
3	C	Red
4	D	Green
5	E	Blue
6	F	Yellow
8	H	Orange

9. ACTUATOR & LEGEND COLOR 5,6

	Handle	Push-Button
No outer Panel Hardware	A	1
Knurled Nut		
Bright nickel	B	2
Bright nickel with locking ring	C	
Black	D	
Black with locking ring	E	
Panel Dress Nut		
Bright nickel	F	
Bright nickel with locking ring	G	
Black	H	
Black with locking ring	J	

10. LEGEND

Handle Actuator Legend Plate (Actuator Styles M & N)

A No Legend Plate
 B ON - OFF Vertical
 C ON - OFF Horizontal
 D I - O Vertical
 E I - O Horizontal

Push-Pull Actuator Button Cap (Actuator Styles T & V)

1¹² No Marking
 2 Rated Amps Horizontal
 3 Rated Amps Line Side Down
 4 Rated Amps Line Side Up

Push-to-Reset Actuator Button (Actuator Styles U & W)

1 No Marking

11. BUSHING COLOR 7

B Black

12. AGENCY APPROVAL 8

J	UL 489A Listed, TUV Certified to IEC/EN 60934
M	UL 1077 Recognized, CSA Accepted
N	UL Recognized, TUV Certified to IEC/EN 60934
T	UL 489A Listed

- One actuator is located in the center of each multi-pole breaker. Actuator codes V & W limited to single pole breakers only.
- Switch Only circuits are not available with Push-To-Reset actuators. For Switch Only circuits, select Current Coil Rating from the above chart.
- One Auxiliary Switch is supplied per breaker. On two-pole breakers, standard Auxiliary Switch mounting is in pole one. Auxiliary Switch option limited to Series Trip and Switch Only circuits.
Not available with Back Connected Screw or Push-in Stud terminals.
- Screw terminals or Push-in Stud recommended above 20 amps.
- Actuator color is only visible in the OFF position on Push-Pull actuators.
- All units have one hex nut installed on bushing for use behind the panel.
- Other colors available. Consult factory.
- UL Recognized, CSA Accepted and UL Listed to 30 amps.
Polarity Sensitive Construction
- Terminal code A available with circuit codes A & B only.
- Printed circuit board available with UL recognized approval only.
- Auxiliary switch (flat Q.C.) available with UL recognized approvals only.
- Push-Pull actuator style is available with the rated amps marked on the cap in white. For no marking, choose code "1".

Circuit & Terminal Diagrams Handle

inches [millimeters]

SERIES TRIP

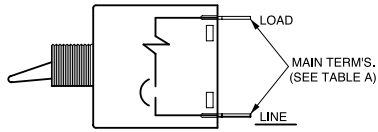

SWITCH ONLY

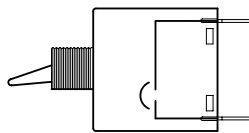

SERIES TRIP W/ AUXILIARY SWITCH

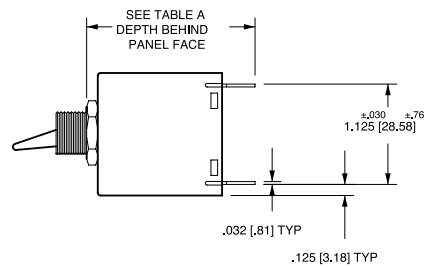
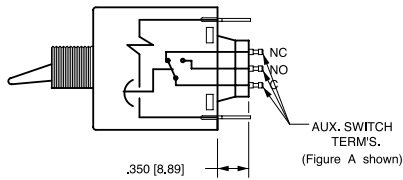

TABLE A		
	TERMINAL DESCRIPTION	DEPTH BEHIND PANEL FACE *
MAIN	TAB (Q.C)	1.890 [48.00]
	SCREW (#8-32)	1.930 [49.03]
	PUSH-IN STUD	2.520 [64.00]
AUX. ** SWITCH	DOUBLE SOLDER TURRET TYPE	2.035 [51.69]
	ROUND Q.C TYPE	2.025 [51.44]
	FLAT QUICK-CONNECT	2.129 [54.08]
	FLAT SOLDER LUG	2.012 [51.10]

*DEPTH INCLUDES BEHIND PANEL HEX NUT AS SUPPLIED ON ALL UNITS.

**WHEN CALLED FOR ON MULTI-POLE UNITS, ONLY ONE AUX. SWITCH IS NORMALLY SUPPLIED, MOUNTED AS SHOWN IN FIG. A

MULTI-POLE IDENTIFICATION SCHEME

SOLDER TURRET AND ROUND QC AUX SWITCH TERMINALS

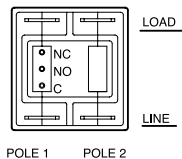

FIG. A

FLAT QC AND SOLDER LUG AUX SWITCH TERMINALS

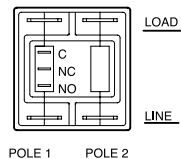
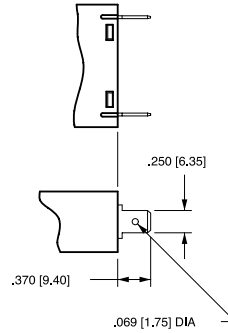

FIG. B

TERMINAL DIMENSIONAL DETAIL

TAB (Q.C.) TERMINAL



SCREW TERMINAL #8-32 WITH UPTURNED LUGS

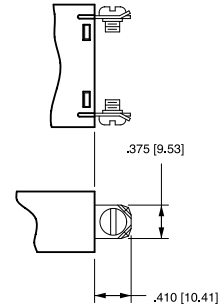

SCREW TERMINAL #8-32 BUS

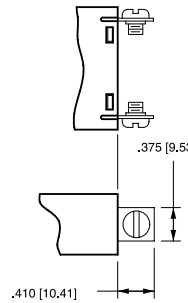

PUSH-IN STUD TERMINAL

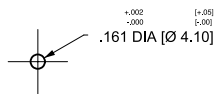
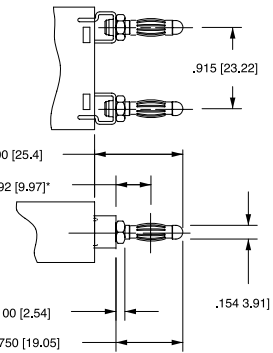

PUSH-IN STUD MATING HOLE

*CENTERLINE OF PUSH-IN STUD CONTACT AREA

AUXILIARY SWITCH TERMINALS

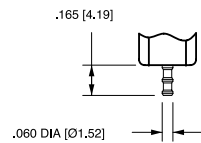

DOUBLE SOLDER TURRET TYPE

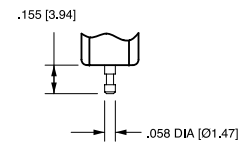

ROUND QUICK-CONNECT TYPE

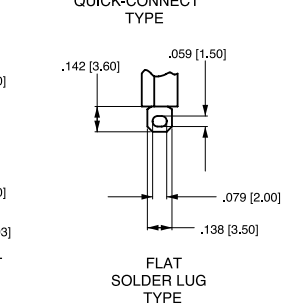
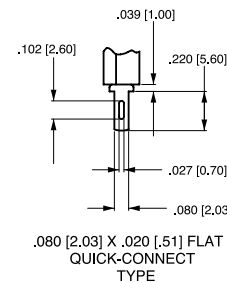

*AVAILABLE THROUGH SPECIAL CATALOG PART NUMBER

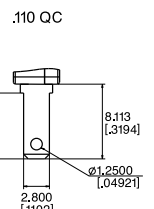

Notes:
1 Tolerance ±.020 [.51] unless otherwise specified.

PC Terminal Diagrams Handle

inches [millimeters]

HANDLE TYPE SHOWN WITHOUT AUX. SWITCH

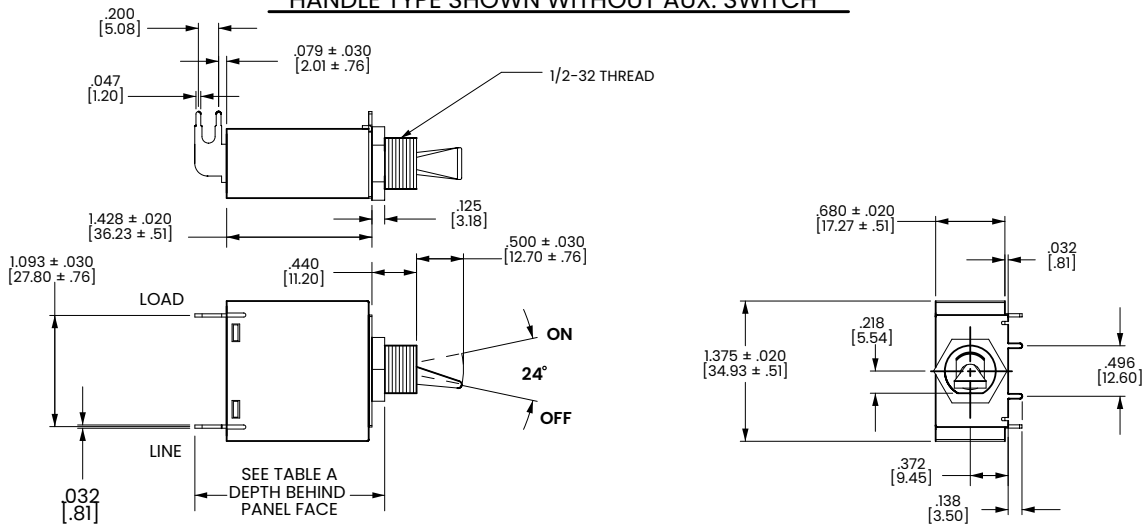

P.C. FOOTPRINT

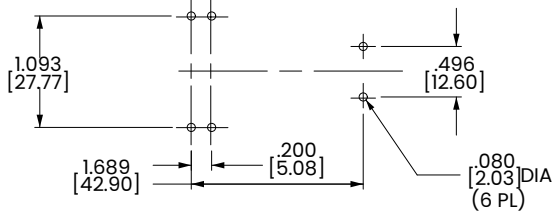

P.C. TERMINAL

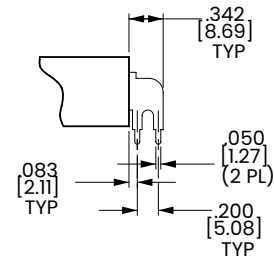

HANDLE TYPE SHOWN WITH AUX. SWITCH

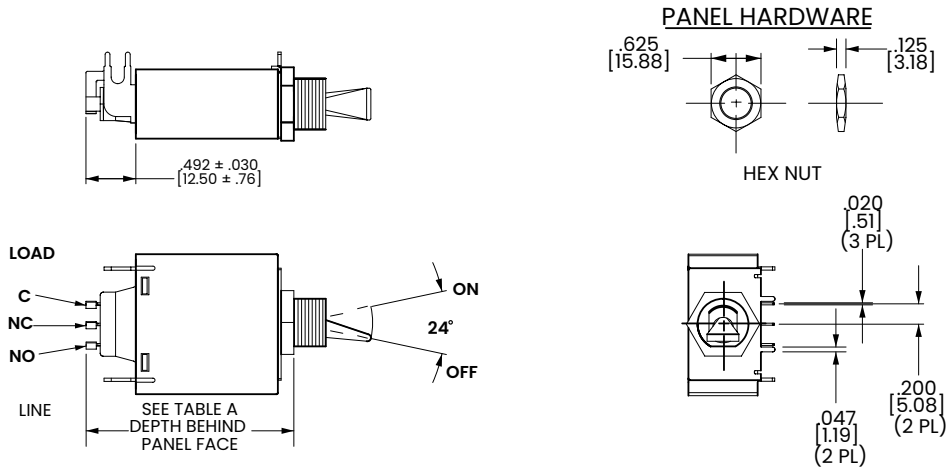

P.C. FOOTPRINT

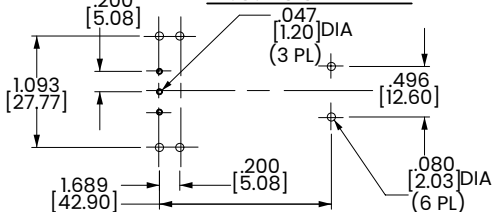

TABLE A		
	TERMINAL DESCRIPTION	DEPTH BEHIND PANEL FACE *
	PRINTED CIRCUIT BOARD	1.957 [49.70]
AUX. SWITCH	PRINTED CIRCUIT BOARD	2.449 [62.20]

*DEPTH INCLUDES BEHIND PANEL HEX NUT AS SUPPLIED ON ALL UNITS

Notes:
1 Tolerance ±.020 [.51] unless otherwise specified.

Dimensional Specs Handle

inches [millimeters]

PADDLE ACTUATOR STYLE

SINGLE POLE

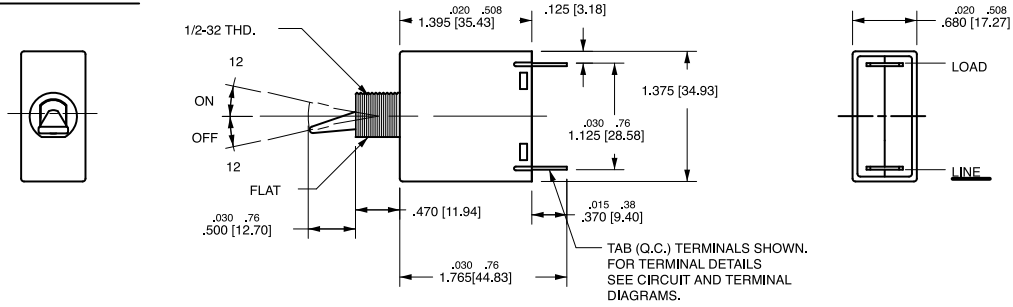

DOUBLE POLE

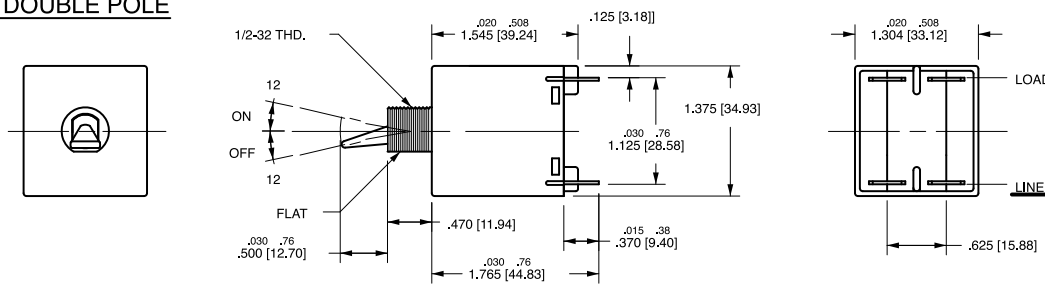

BATON ACTUATOR STYLE

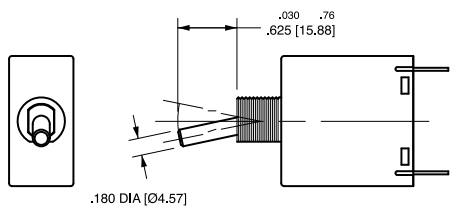

MOUNTING DETAILS

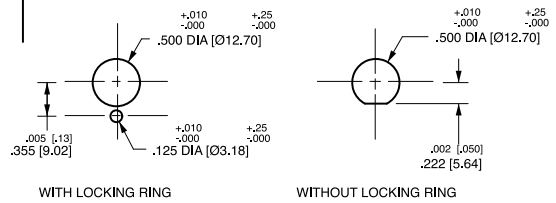

LEGEND PLATES

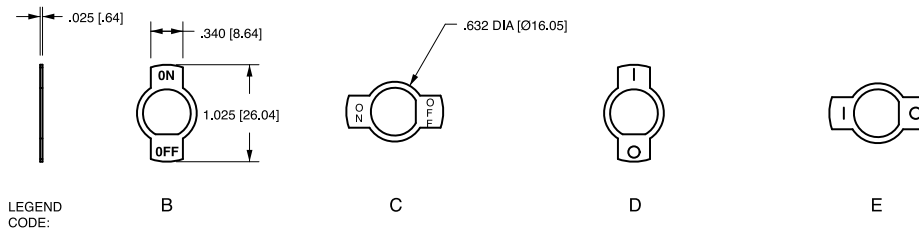

PANEL HARDWARE

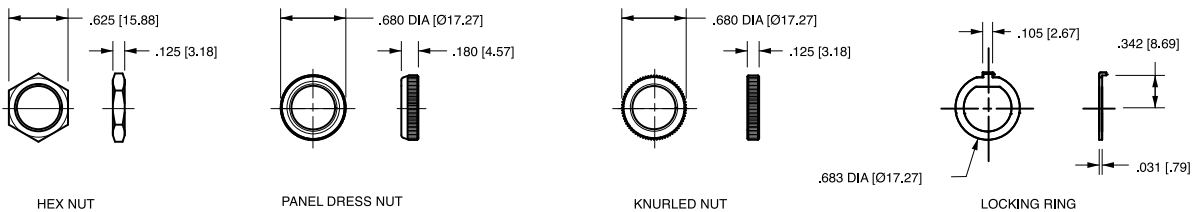

Notes:
1 Tolerance ± 0.020 [.51] unless otherwise specified.

Circuit & Terminal Diagrams Pushbutton

inches [millimeters]

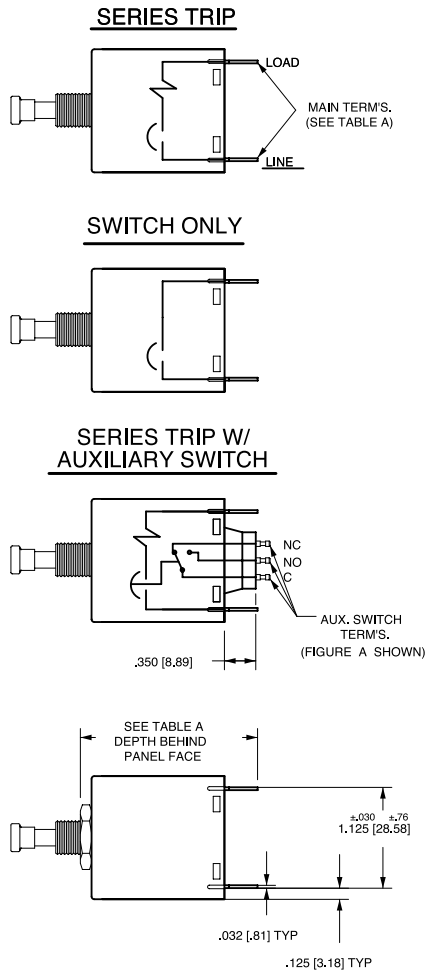
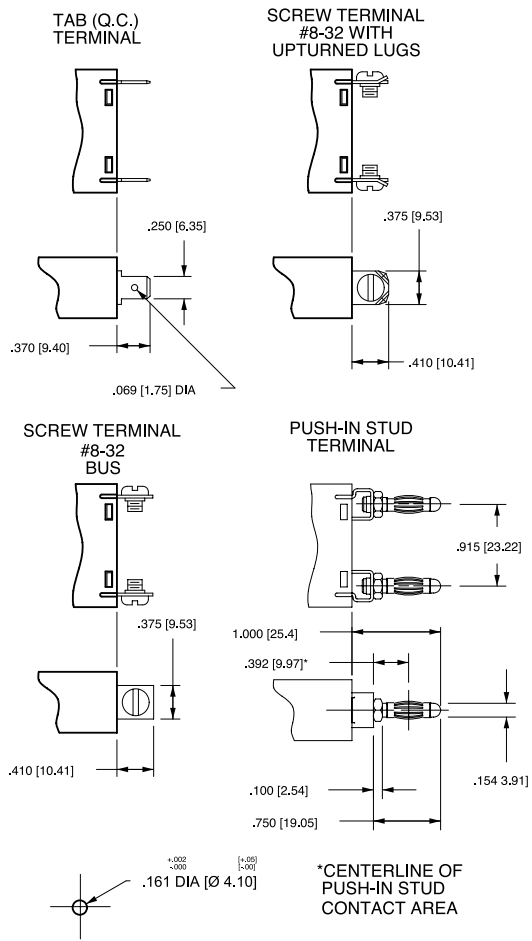

TABLE A		
TERMINAL DESCRIPTION		DEPTH BEHIND PANEL FACE *
MAIN	TAB (Q.C.)	1.952 [49.57]
	SCREW (#8-32)	1.992 [50.60]
	PUSH-IN STUD	2.582 [65.58]
AUX. ** SWITCH	DOUBLE SOLDER TURRET TYPE	2.097 [53.26]
	ROUND Q.C. TYPE	2.087 [53.01]
	FLAT QUICK-CONNECT	2.191 [55.65]
	FLAT SOLDER LUG	2.074 [52.68]

*DEPTH INCLUDES BEHIND PANEL HEX NUT AS SUPPLIED ON ALL UNITS.
 ** WHEN CALLED FOR ON MULTI-POLE UNITS, ONLY ONE AUX. SWITCH IS NORMALLY SUPPLIED, MOUNTED AS SHOWN IN FIG. A

TERMINAL DIMENSIONAL DETAIL



AUXILIARY SWITCH TERMINALS

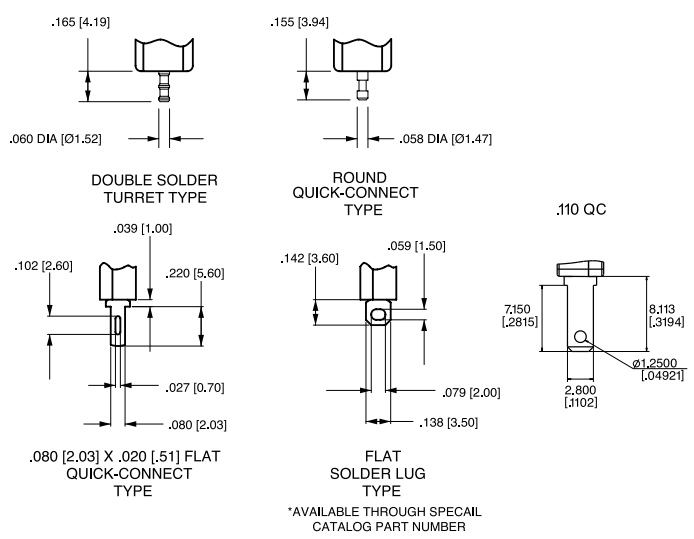

MULTI-POLE IDENTIFICATION SCHEME

SOLDER TURRET AND ROUND QC AUX SWITCH TERMINALS

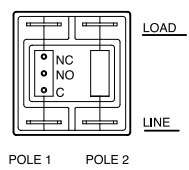

FIG. A

FLAT QC AND SOLDER LUG AUX SWITCHTERMINALS

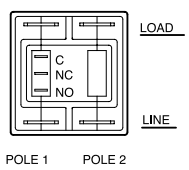
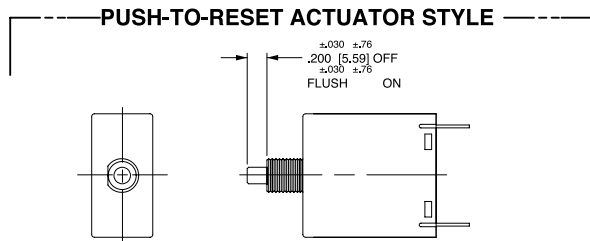
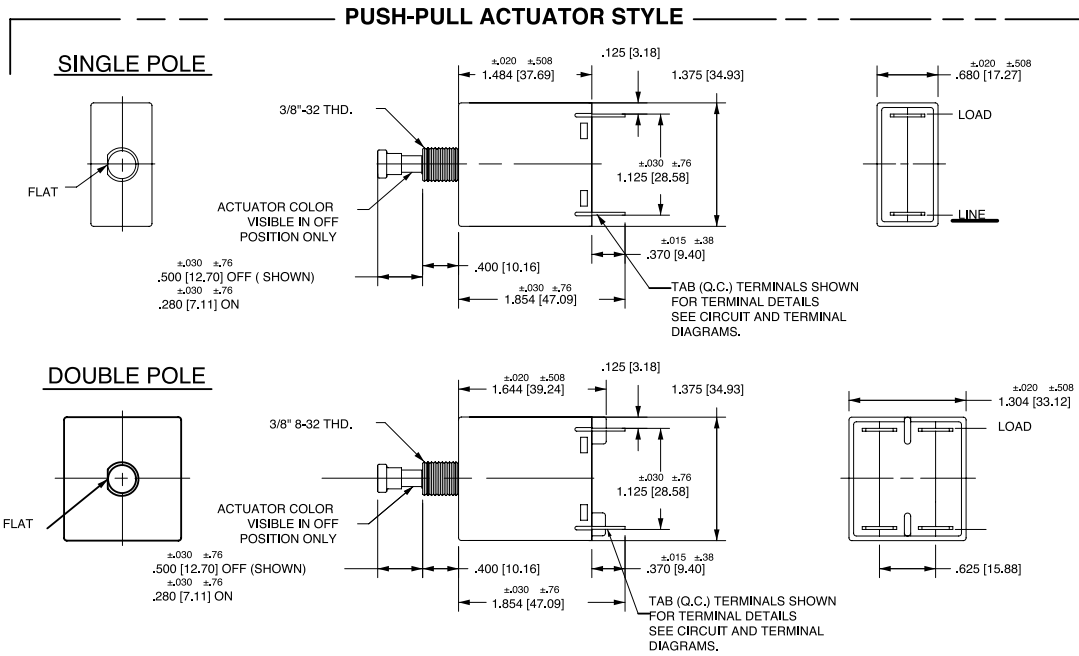

FIG. B

Notes:
 1 Tolerance ±.020 [.51] unless otherwise specified.

Dimensional Specs Pushbutton

inches [millimeters]



MOUNTING DETAILS

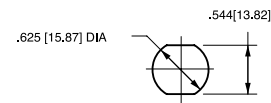
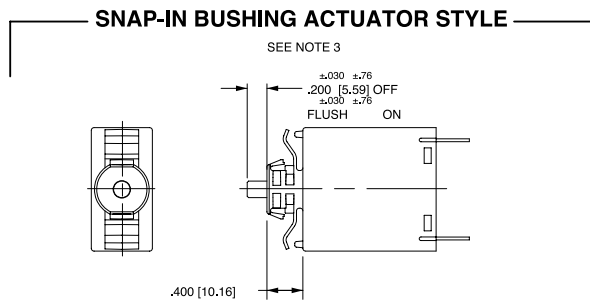
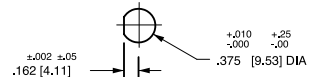

PANEL HARDWARE



HEX NUT

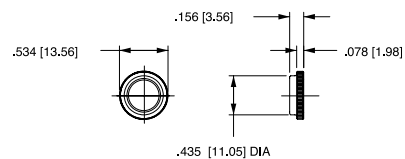

PANEL DRESS NUT

BUTTON MARKING ORIENTATION (PUSH-PULL ONLY)

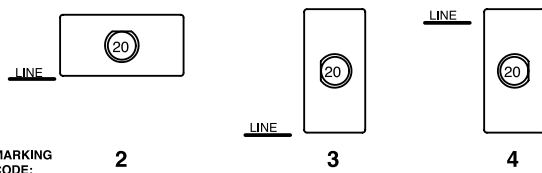

Notes:
 1 All dimensions are in inches [millimeters].
 2 Available with Push-Pull or Push-to-Reset Actuators

PC Terminal Diagrams Push-Pull

inches [millimeters]

PUSH-PULL TYPE SHOWN WITHOUT AUX. SWITCH

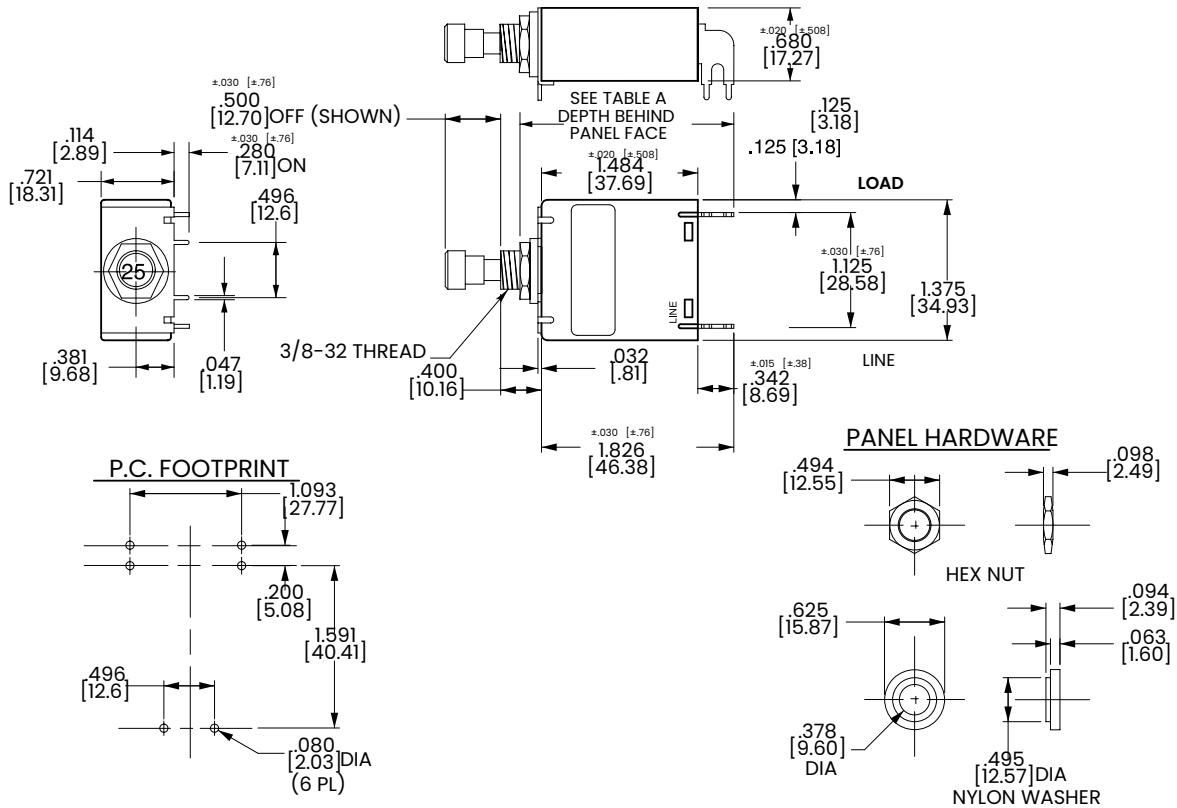

PUSH-PULL TYPE SHOWN WITH AUX. SWITCH

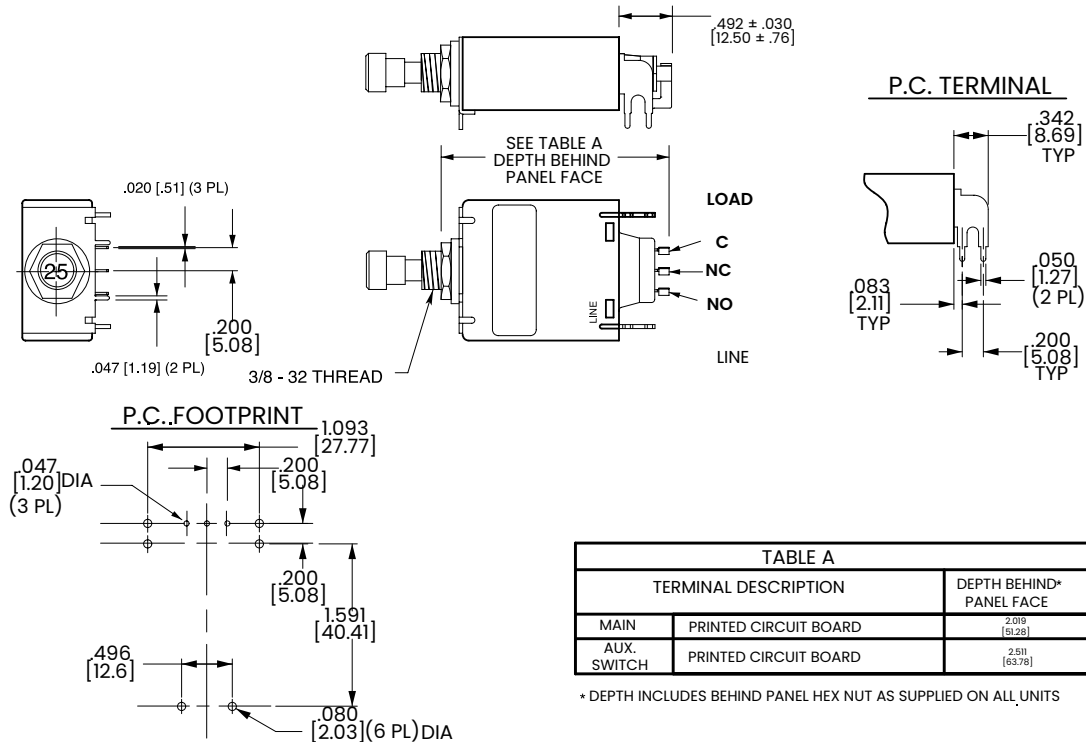

TABLE A		
TERMINAL DESCRIPTION		DEPTH BEHIND* PANEL FACE
MAIN	PRINTED CIRCUIT BOARD	2.019 [51.28]
AUX. SWITCH	PRINTED CIRCUIT BOARD	2.51 [63.78]

* DEPTH INCLUDES BEHIND PANEL HEX NUT AS SUPPLIED ON ALL UNITS

Notes:

1 Tolerance ± 0.020 [.51] unless otherwise specified.

Time Delay

M, MS-SERIES TIME DELAY VALUES										
TRIP TIME SECONDS	PERCENT OF RATED CURRENT									
	Delay	100%	135%	150%	200%	400%	600%	800%	1000%	1200%
	10, 20, 30	No Trip	May Trip	.100 Max	.100 Max	.100 Max	.100 Max	.100 Max	.100 Max	.100 Max
12, 22, 32, 62, 72, 92	No Trip	.300 - 7.00	.200 - 5.00	.100 - 2.00	.030 - .500	.008 - .300	.006 - .150	.005 - .100	.005 - .100	.005 - .100
14, 24, 34, 64, 74, 94	No Trip	3.00 - 70.0	2.00 - 40.0	1.00 - 15.0	.100 - 4.00	.008 - 2.00	.006 - .800	.005 - .350	.005 - .160	.005 - .160

Notes:

- 1 Delay Curves 12,14, 22, 24, 32, 34, 62, 64, 72, 74, 92, 94: Breakers to hold 100% and must trip at 135% of rated current and greater within the time limit shown in this curve.
- 2 Delay Curves 10, 20, 30: Breakers to hold 100% and must trip at 150% of rated current and greater within the time limit shown in this curve.
- 3 All Curves: Curve data shown represents breaker response at ambient temperature of 77°F (25°C) with no preloading. Breakers are mounted in standard wall-mount position.
- 4 The minimum inrush pulse tolerance handling capability is 12 times the rated current on standard delays and 18 times the rated current on high inrush delays. These values are based on a 60 Hz 1/2 cycle, 8.33 ms pulse. High inrush delays should be specified for applications with high initial surge currents of short duration, such as switching power supplies, highly capacitive loads and transformer loads.

Dual Rated AC/DC

Instantaneous

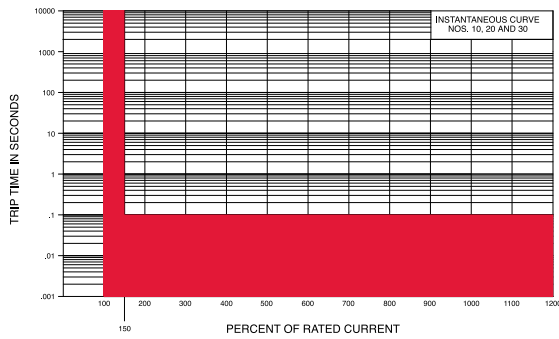

Short

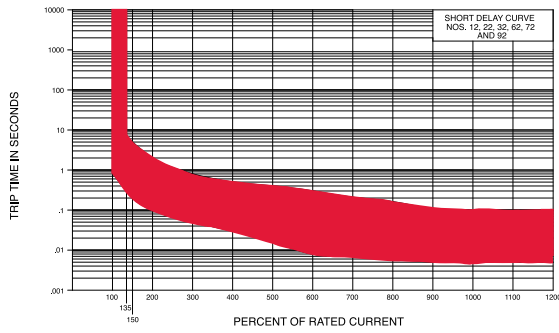

Short D2

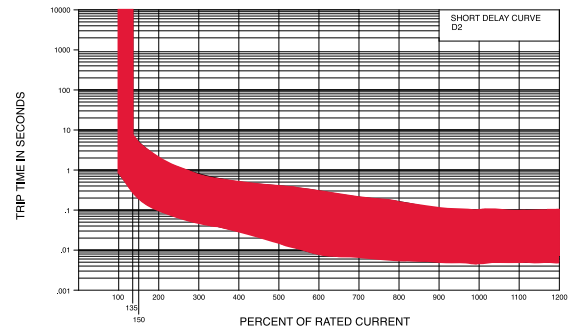

Medium

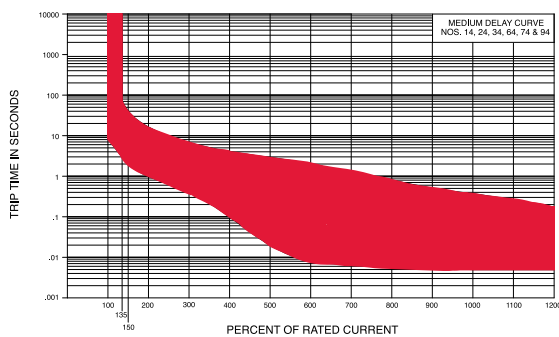

Medium D4

