

PS-4

Order No.: 3030970



Test adapter, Color: red

Commercial data

EAN	 4 017918 818913
Pack	10
Customs tariff	85369010
Gross weight in pieces	3.19 g
Country of Origin	PL
Catalog page information	Page 394 (CL1-2011)

Product notesWEEE/RoHS-compliant since:
01/01/2003

Please note that the data given here has been taken from the online catalog. For comprehensive information and data, please refer to the user documentation at <http://www.download.phoenixcontact.com>. The General Terms and Conditions of Use apply to Internet downloads.

Certificates

Certification

Certifications applied for:

Certification Ex:

Drawings

Dimensioned drawing

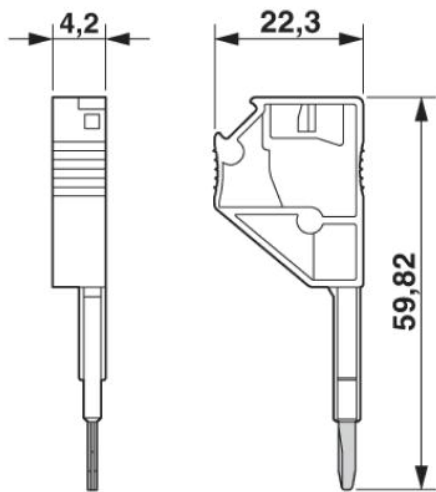

Address

PHOENIX CONTACT Ltd
Halesfield 13
Telford / Shropshire / TF7 4PG,England
Phone 01952 681 700
Fax 01952 681 799
<http://www.phoenixcontact.co.uk>



Phoenix Contact Ltd.
Technical modifications reserved;