

## GNSS LOW NOISE AMPLIFIER GaAs MMIC

### ■ GENERAL DESCRIPTION

NJG1130KA1 is a low noise amplifier GaAs MMIC designed for GNSS (Global Navigation Satellite Systems). The LNA offers excellent low noise figure, high linearity and low current consumption. Two stage amplifier and ESD protection circuit are integrated in the IC to achieve very high gain and high ESD tolerance. An ultra-small and ultra-thin package of FLP6-A1 is adopted.

### ■ PACKAGE OUTLINE



### ■ APPLICATIONS

GNSS applications, like GPS, Galileo, GLONASS and COMPASS PND (Personal Navigation Device), Car Navigation, Tablet PC, Mobile Phone, and others mobile device applications  
GPS L2 Band application

Note: For GPS L2 Band application please refer to Application Note

### ■ FEATURES

- Low voltage operation +2.85V typ.
- Low current consumption 5.0mA typ.
- High gain 29.0dB typ. @ f=1575MHz
- Low noise figure 0.65dB typ. @ f=1575MHz
- 1dB gain compression output power +11.0dBm typ. @ f=1575MHz
- High output IP3 +14dBm typ. @ f=1575+1575.1MHz, Pin=-35dBm
- Ultra-small & ultra-thin package FLP6-A1 (Package size: 1.6 x 1.6 x 0.6mm)

### ■ PIN CONFIGURATION

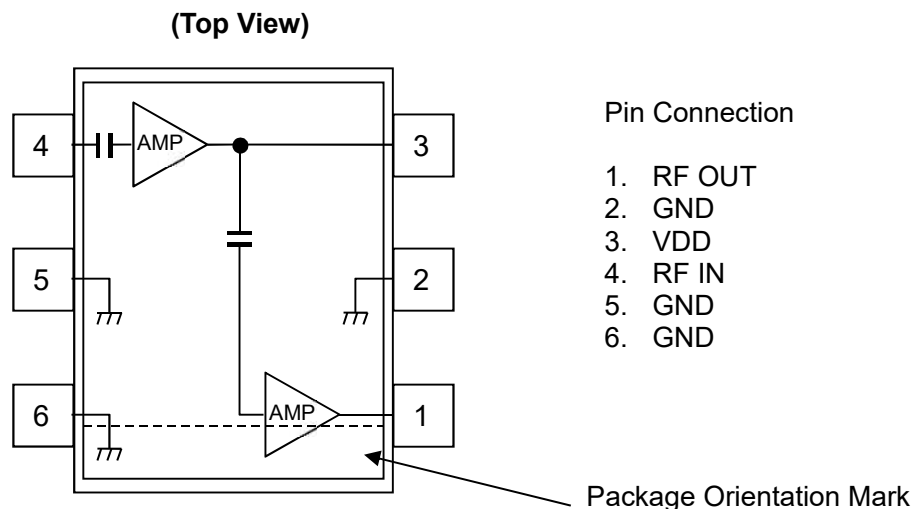

Note: Specifications and description listed in this datasheet are subject to change without notice.

## ■ ABSOLUTE MAXIMUM RATINGS

$T_a=+25^{\circ}\text{C}$ ,  $Z_s=Z_l=50\Omega$

PARAMETERS	SYMBOL	CONDITIONS	RATINGS	UNITS
Drain Voltage	$V_{DD}$		5.0	V
Input power	$P_{in}$	$V_{DD}=2.85\text{V}$	+15	dBm
Power dissipation	$P_D$	on PCB board, at $T_{jmax}=150^{\circ}\text{C}$	170	mW
Operating temperature	$T_{opr}$		-40~+85	$^{\circ}\text{C}$
Storage temperature	$T_{stg}$		-55~+150	$^{\circ}\text{C}$

## ■ ELECTRICAL CHARACTERISTICS

GENERAL CONDITIONS:  $V_{DD}=2.85\text{V}$ ,  $f_{RF}=1575\text{MHz}$ ,  $T_a=+25^{\circ}\text{C}$ ,  $Z_s=Z_l=50\Omega$ , with application circuit

PARAMETERS	SYMBOL	CONDITIONS	MIN	TYP	MAX	UNITS
Operating voltage	$V_{DD}$		2.5	2.85	3.3	V
Operating current	$I_{DD}$	RF OFF	-	5.0	8.5	mA
Small signal gain	Gain		26.0	29.0	31.5	dB
Noise figure	NF	Exclude PCB & connector losses (0.10dB)	-	0.65	0.95	dB
1dB gain compression output power	$P_{-1dB(out)}$		+5.0	+11.0	-	dBm
3rd order output intercept point	OIP3	$f_1=f_{RF}$ , $f_2=f_1+100\text{kHz}$ , $P_{in}=-35\text{dBm}$	+7.0	+14.0	-	dBm
RF IN VSWR	VSWR <sub>i</sub>		-	2.4	2.8	
RF OUT VSWR	VSWR <sub>o</sub>		-	1.6	2.0	

## ELECTRICAL CHARACTERISTICS

(Condition:  $T_a=+25^\circ\text{C}$ ,  $V_{DD}=2.85\text{V}$ ,  $Z_s=Z_l=50\Omega$  with application circuit)

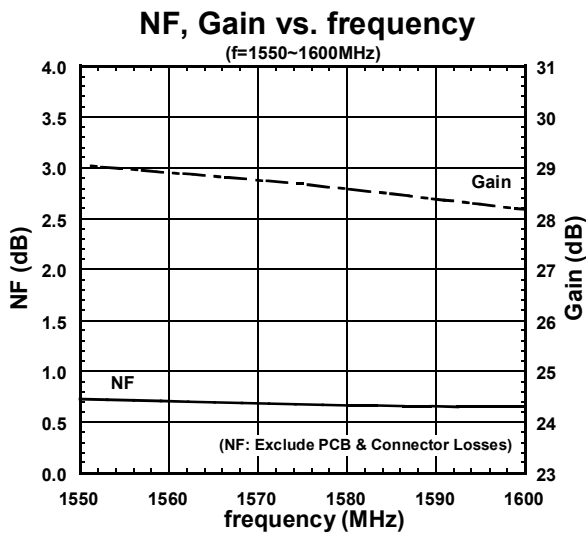
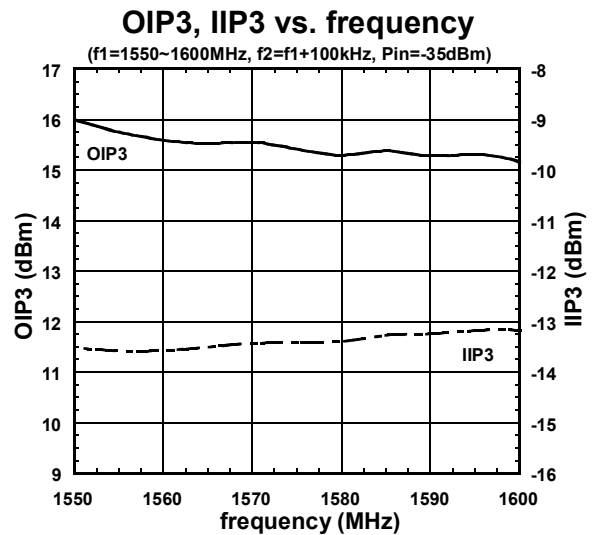
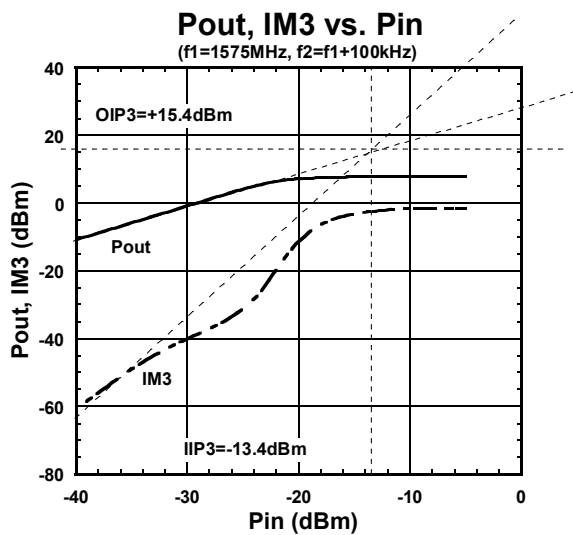
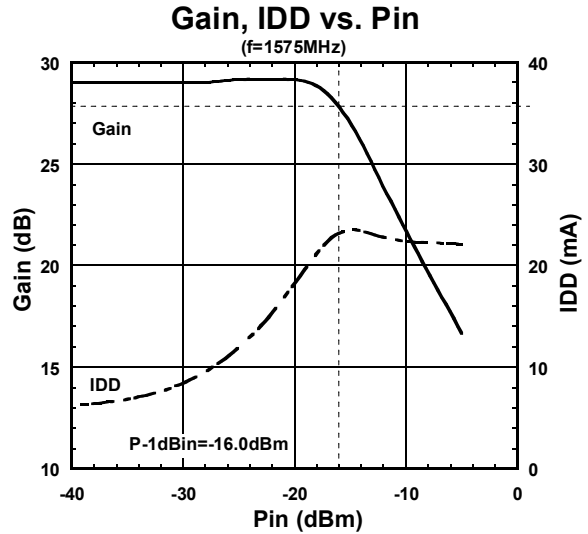
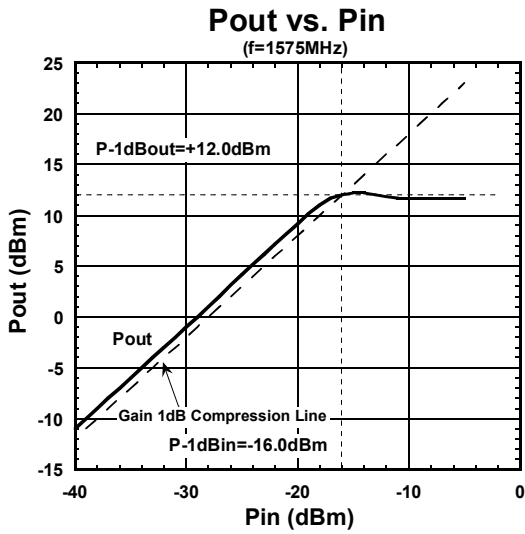

## ELECTRICAL CHARACTERISTICS

(Condition:  $T_a=+25^\circ\text{C}$ ,  $Z_s=Z_l=50\Omega$  with application circuit)

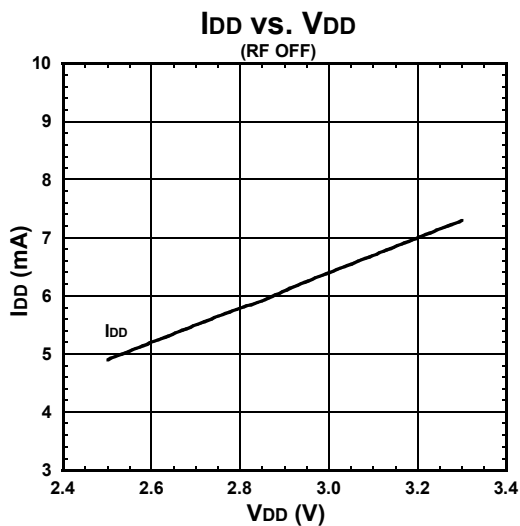
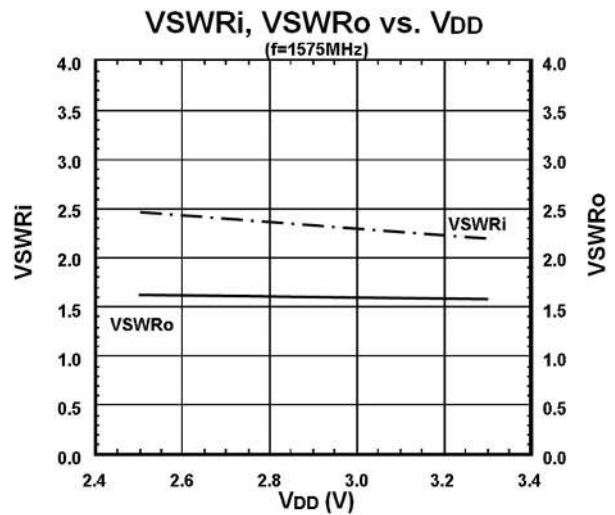
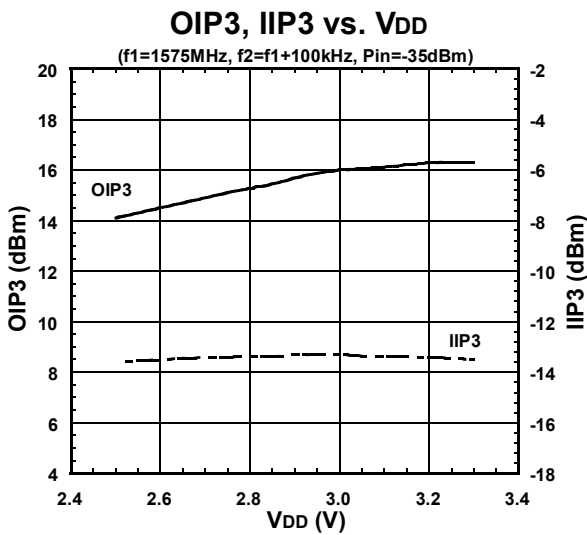
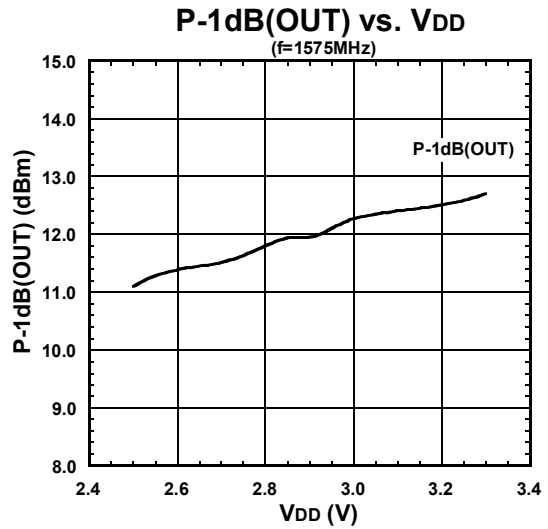
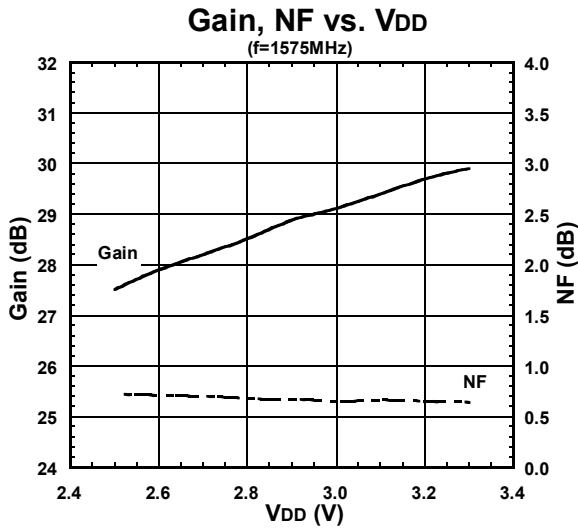

## ELECTRICAL CHARACTERISTICS

(Condition:  $V_{DD}=2.85V$ ,  $Z_s=Z_l=50\Omega$  with application circuit)

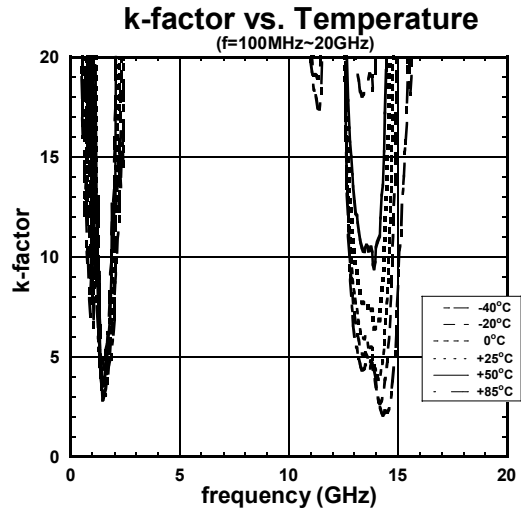
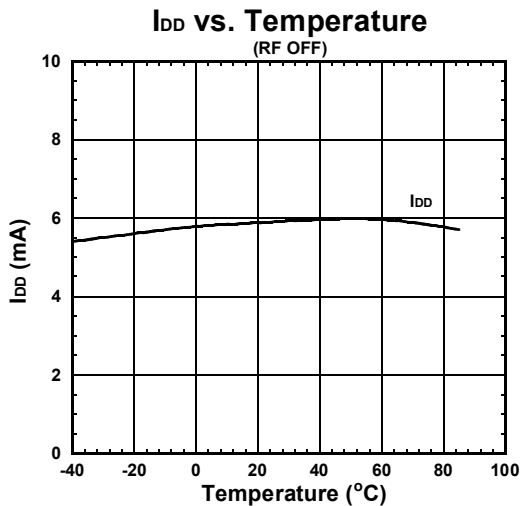
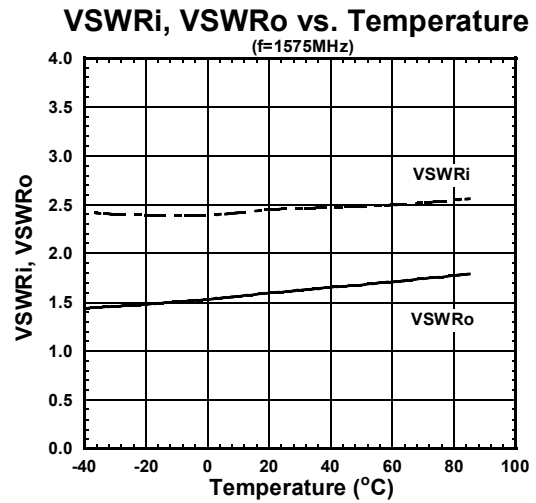
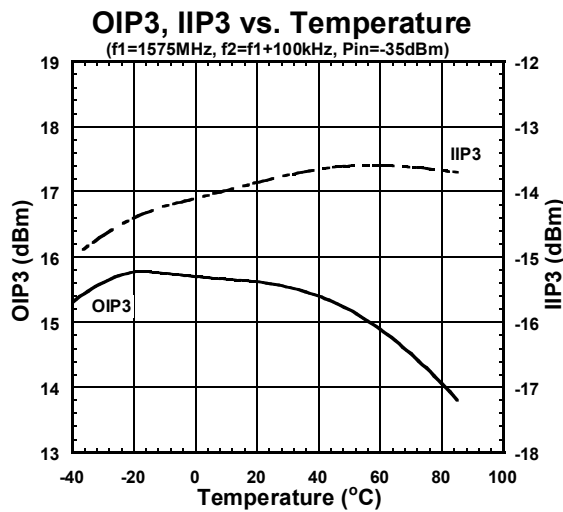
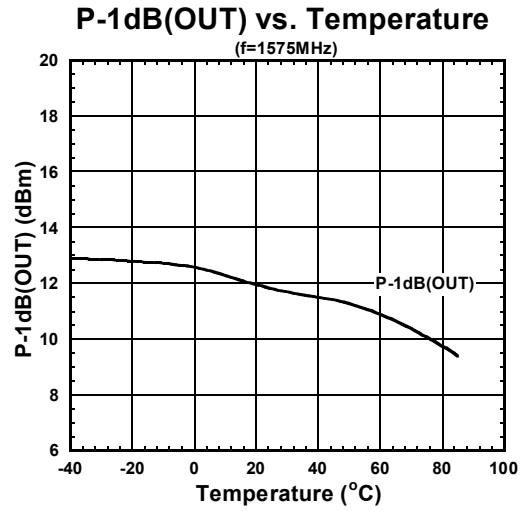
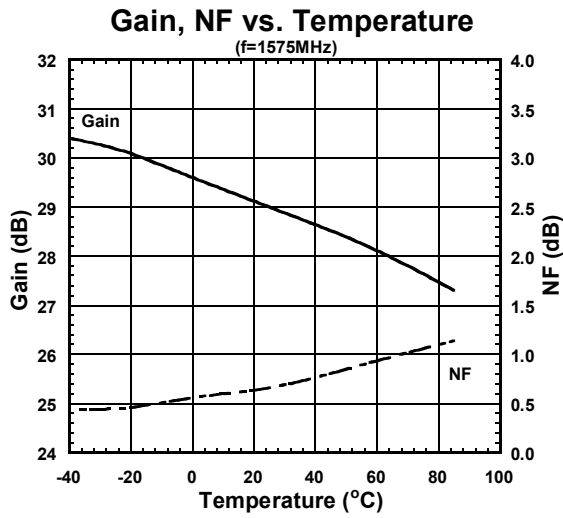

## ELECTRICAL CHARACTERISTICS

(Condition:  $T_a=+25^\circ\text{C}$ ,  $V_{DD}=2.85\text{V}$ ,  $Z_s=Z_l=50\Omega$  with application circuit)

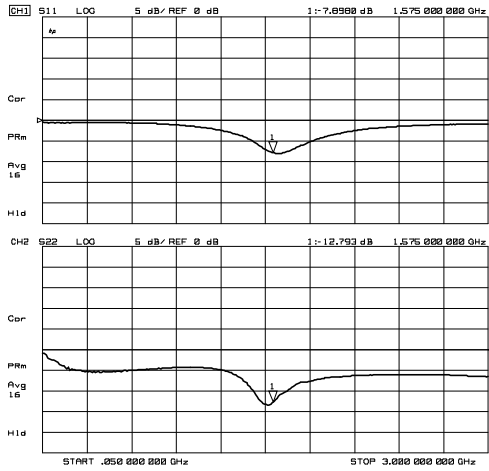

**S11, S22**

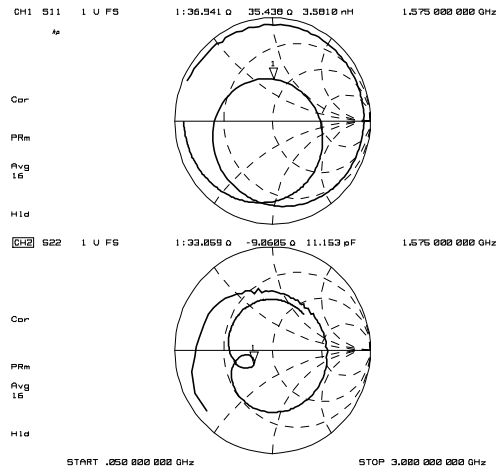

**Zin, Zout**

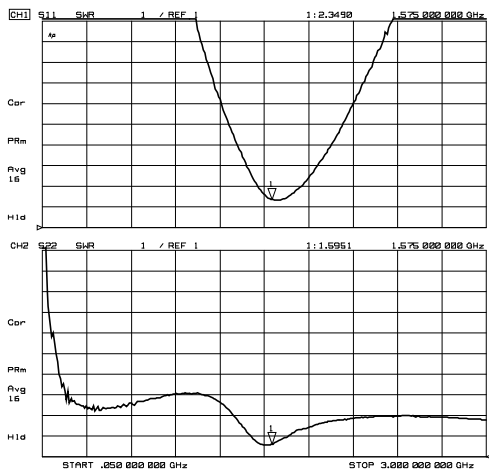

**VSWR**

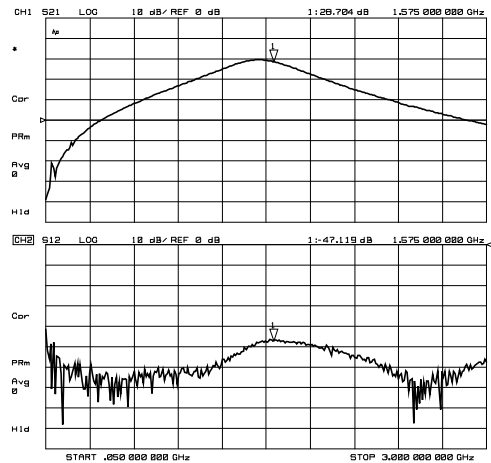

**S21, S12**

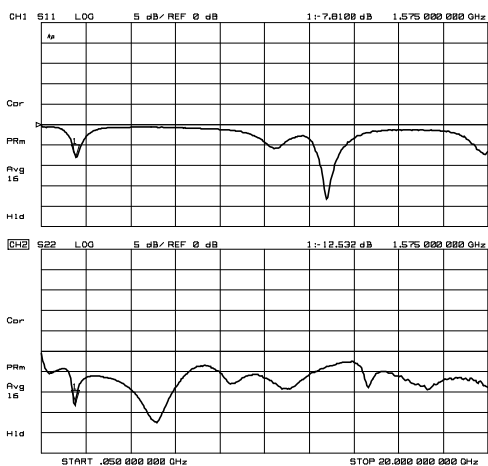

**S11, S22 (~20GHz)**

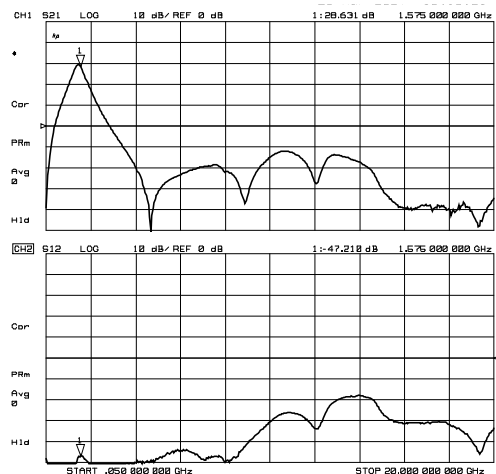

**S21, S12 (~20GHz)**

## APPLICATION CIRCUIT

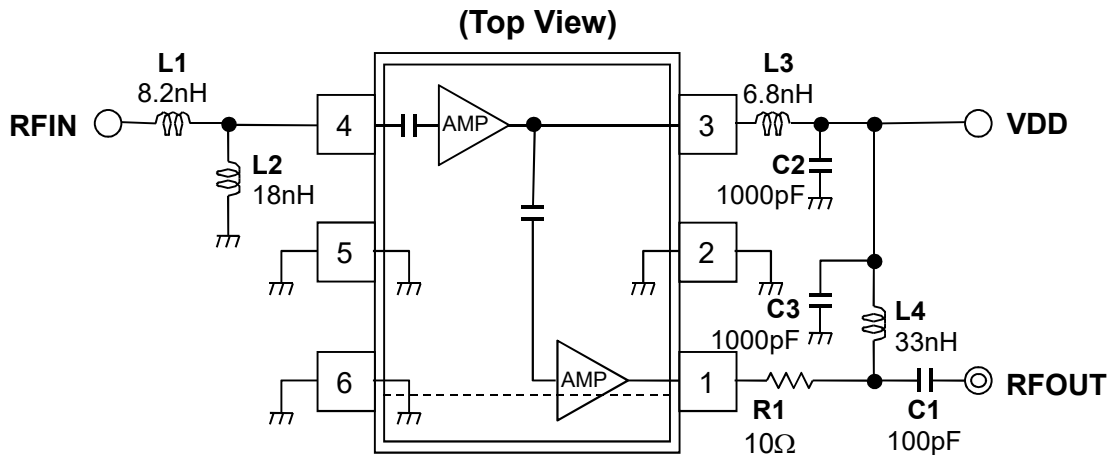

### NOTES:

- L1 and L2 form the input matching circuit. The LNA has integrated coupling and DC-blocking capacitor at the input.
- L3 is a matching inductor of the integrated 1<sup>st</sup> amplifier and 2<sup>nd</sup> amplifier. It should be connected to the terminal3 as close as possible.
- L4 is an output matching inductor.
- C1 is a coupling and DC-blocking capacitor at the output.
- C2 and C3 are bypass capacitors. They should be connected between L3 and L4. C2 should be placed to the side of L3, and C3 should be placed to the side of L4, and should not be directly connected L3 and L4.
- R1 is a stability resistor at high frequency, and it should be connected to the terminal1.
- Ground terminal (No.2, 5, 6) should be connected to the ground plane as close as possible for good RF performance.
- For good performance, the terminal1,3 and 4 should not be coupled though floating-capacitance which exists between RF transmission lines.

## ■ TEST PCB LAYOUT

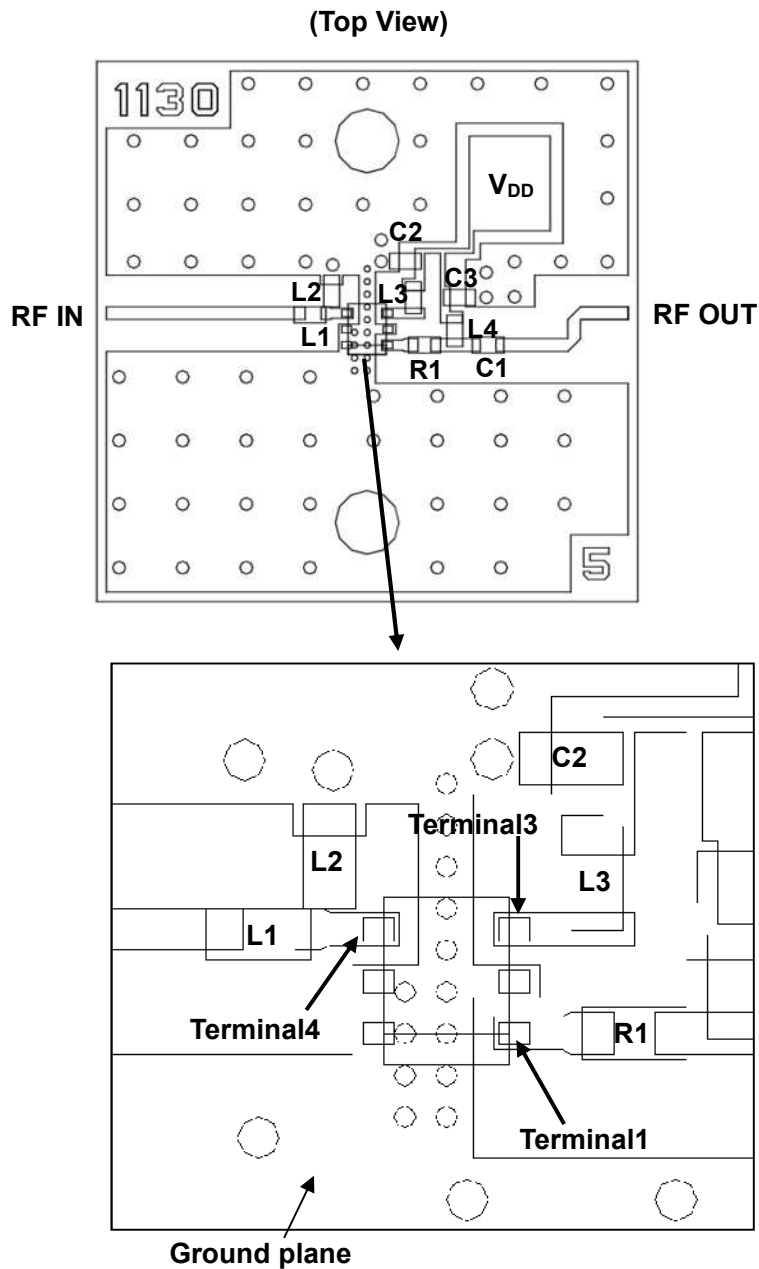

## ■ Parts List

Parts ID	Comment
L1 to L4	TAIYO-YUDEN HK1005 Series
C1 to C3	MURATA GRM15 Series
R1	1005 Size

PCB (FR-4):  
 $t=0.2\text{mm}$   
 MICROSTRIP LINE WIDTH  
 $=0.4\text{mm}$  ( $Z_0=50\Omega$ )  
 PCB SIZE  
 $=17.0\text{mm} \times 17.0\text{mm}$

### PRECAUTION:

- [1] For good performance, the terminal1, 3 and 4 should not be coupled though floating-capacitance which exists between RF transmission lines.
- [2] In order not to couple with terminal 1, 3 and 4, please layout ground pattern under the IC.
- [3] C2 should be placed to the side of L3, and C3 should be placed the side of L4. They should be connect between L3 and L4, should not be directly connected L3 and L4.



## TEST CIRCUITS

Test Circuits 1 to 3 define the test conditions used in the product electrical characteristics table.

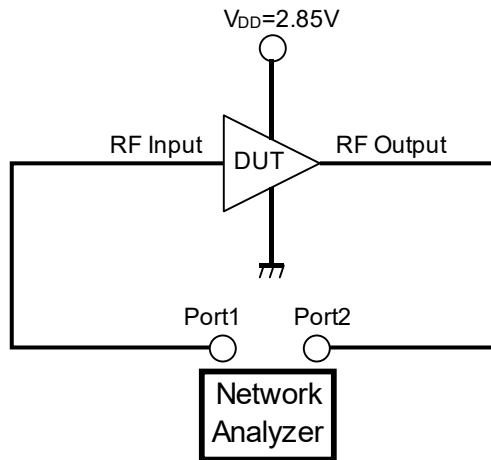

**Test Circuit 1. S-Parameter**

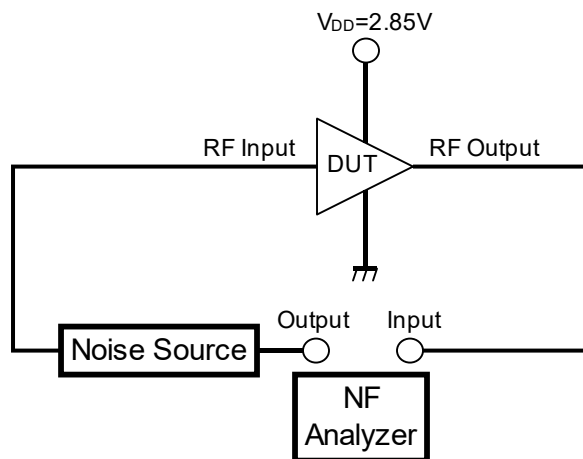

**Test Circuit 2. NF**

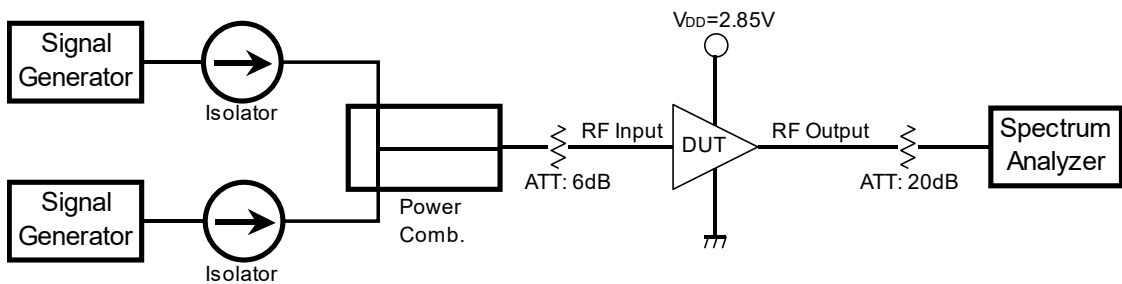

**Test Circuit 3. Third order output intercept point**

## ■ PACKAGE OUTLINE (FLP6-A1)

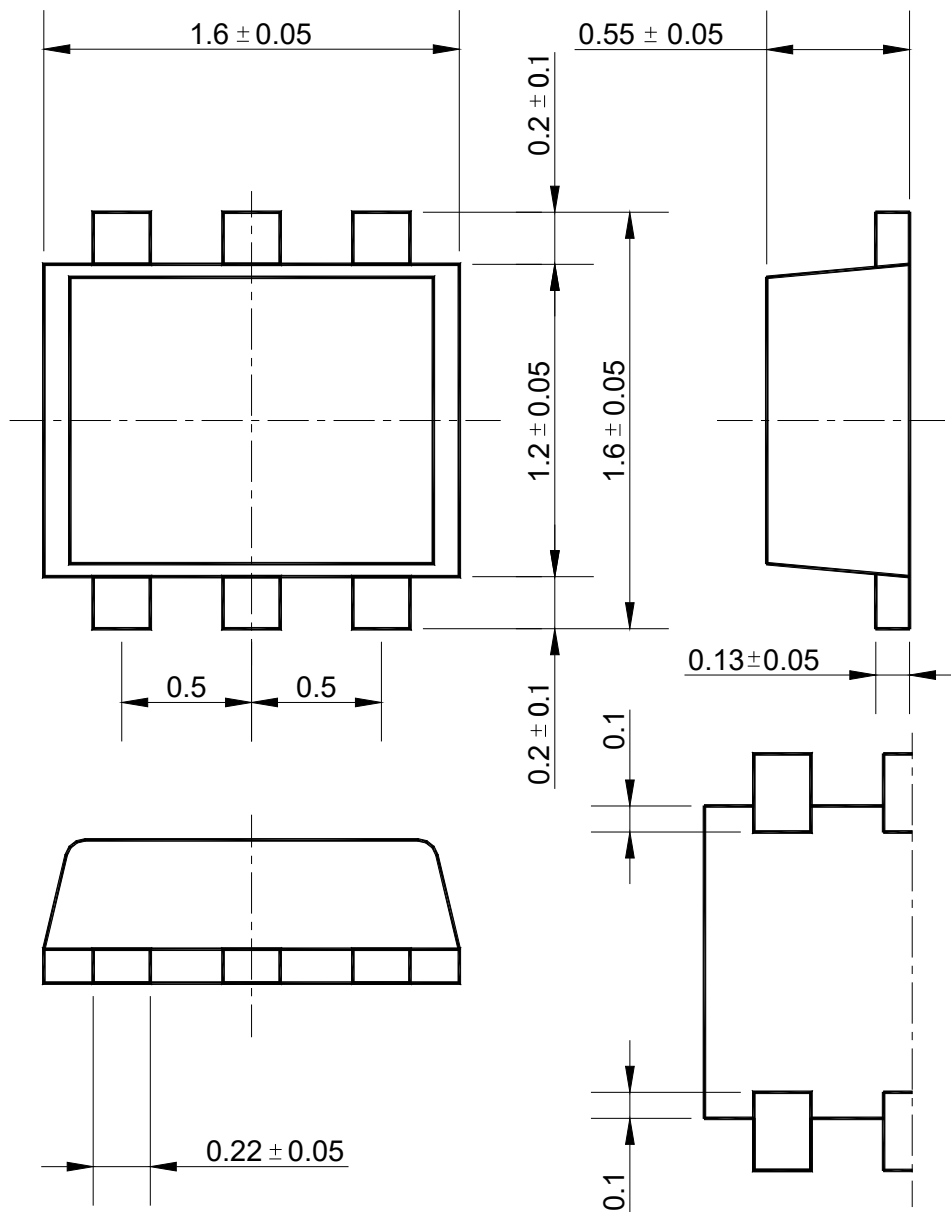

UNIT: mm

### Cautions on using this product

This product contains Gallium-Arsenide (GaAs) which is a harmful material.

- Do NOT eat or put into mouth.
- Do NOT dispose in fire or break up this product.
- Do NOT chemically make gas or powder with this product.
- To waste this product, please obey the relating law of your country.

### [CAUTION]

The specifications on this databook are only given for information, without any guarantee as regards either mistakes or omissions. The application circuits in this databook are described only to show representative usages of the product and not intended for the guarantee or permission of any right including the industrial rights.

This product may be damaged with electric static discharge (ESD) or spike voltage. Please handle with care to avoid these damages.

1. The products and the product specifications described in this document are subject to change or discontinuation of production without notice for reasons such as improvement. Therefore, before deciding to use the products, please refer to our sales representatives for the latest information thereon.
2. The materials in this document may not be copied or otherwise reproduced in whole or in part without the prior written consent of us.
3. This product and any technical information relating thereto are subject to complementary export controls (so-called KNOW controls) under the Foreign Exchange and Foreign Trade Law, and related politics ministerial ordinance of the law. (Note that the complementary export controls are inapplicable to any application-specific products, except rockets and pilotless aircraft, that are insusceptible to design or program changes.) Accordingly, when exporting or carrying abroad this product, follow the Foreign Exchange and Foreign Trade Control Law and its related regulations with respect to the complementary export controls.
4. The technical information described in this document shows typical characteristics and example application circuits for the products. The release of such information is not to be construed as a warranty of or a grant of license under our or any third party's intellectual property rights or any other rights.
5. The products listed in this document are intended and designed for use as general electronic components in standard applications (office equipment, telecommunication equipment, measuring instruments, consumer electronic products, amusement equipment etc.). Those customers intending to use a product in an application requiring extreme quality and reliability, for example, in a highly specific application where the failure or misoperation of the product could result in human injury or death should first contact us.
  - Aerospace Equipment
  - Equipment Used in the Deep Sea
  - Power Generator Control Equipment (nuclear, steam, hydraulic, etc.)
  - Life Maintenance Medical Equipment
  - Fire Alarms / Intruder Detectors
  - Vehicle Control Equipment (automotive, airplane, railroad, ship, etc.)
  - Various Safety Devices
  - Traffic control system
  - Combustion equipment

In case your company desires to use this product for any applications other than general electronic equipment mentioned above, make sure to contact our company in advance. Note that the important requirements mentioned in this section are not applicable to cases where operation requirements such as application conditions are confirmed by our company in writing after consultation with your company.

6. We are making our continuous effort to improve the quality and reliability of our products, but semiconductor products are likely to fail with certain probability. In order to prevent any injury to persons or damages to property resulting from such failure, customers should be careful enough to incorporate safety measures in their design, such as redundancy feature, fire containment feature and fail-safe feature. We do not assume any liability or responsibility for any loss or damage arising from misuse or inappropriate use of the products.
7. The products have been designed and tested to function within controlled environmental conditions. Do not use products under conditions that deviate from methods or applications specified in this datasheet. Failure to employ the products in the proper applications can lead to deterioration, destruction or failure of the products. We shall not be responsible for any bodily injury, fires or accident, property damage or any consequential damages resulting from misuse or misapplication of the products.
8. **Quality Warranty**
  - 8-1. **Quality Warranty Period**

In the case of a product purchased through an authorized distributor or directly from us, the warranty period for this product shall be one (1) year after delivery to your company. For defective products that occurred during this period, we will take the quality warranty measures described in section 8-2. However, if there is an agreement on the warranty period in the basic transaction agreement, quality assurance agreement, delivery specifications, etc., it shall be followed.
  - 8-2. **Quality Warranty Remedies**

When it has been proved defective due to manufacturing factors as a result of defect analysis by us, we will either deliver a substitute for the defective product or refund the purchase price of the defective product.

Note that such delivery or refund is sole and exclusive remedies to your company for the defective product.
  - 8-3. **Remedies after Quality Warranty Period**

With respect to any defect of this product found after the quality warranty period, the defect will be analyzed by us. On the basis of the defect analysis results, the scope and amounts of damage shall be determined by mutual agreement of both parties. Then we will deal with upper limit in Section 8-2. This provision is not intended to limit any legal rights of your company.
9. Anti-radiation design is not implemented in the products described in this document.
10. The X-ray exposure can influence functions and characteristics of the products. Confirm the product functions and characteristics in the evaluation stage.
11. WLCSP products should be used in light shielded environments. The light exposure can influence functions and characteristics of the products under operation or storage.
12. Warning for handling Gallium and Arsenic (GaAs) products (Applying to GaAs MMIC, Photo Reflector). These products use Gallium (Ga) and Arsenic (As) which are specified as poisonous chemicals by law. For the prevention of a hazard, do not burn, destroy, or process chemically to make them as gas or power. When the product is disposed of, please follow the related regulation and do not mix this with general industrial waste or household waste.
13. Please contact our sales representatives should you have any questions or comments concerning the products or the technical information.



**Nisshinbo Micro Devices Inc.**

**Official website**

<https://www.nisshinbo-microdevices.co.jp/en/>

**Purchase information**

<https://www.nisshinbo-microdevices.co.jp/en/buy/>