

# IRFB4115GPbF

HEXFET® Power MOSFET

## Applications

- High Efficiency Synchronous Rectification in SMPS
- Uninterruptible Power Supply
- High Speed Power Switching
- Hard Switched and High Frequency Circuits

## Benefits

- Improved Gate, Avalanche and Dynamic  $dV/dt$  Ruggedness
- Fully Characterized Capacitance and Avalanche SOA
- Enhanced body diode  $dV/dt$  and  $dI/dt$  Capability
- Lead-Free
- Halogen-Free

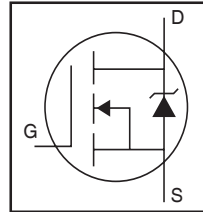

$V_{DSS}$		<b>150V</b>
$R_{DS(on)}$ <b>typ. max.</b>		<b>9.3mΩ</b>
		<b>11mΩ</b>
$I_D$ (Silicon Limited)		<b>104A</b>

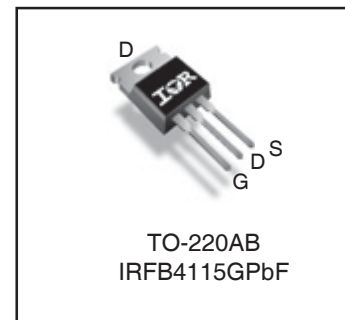

<b>G</b>	<b>D</b>	<b>S</b>
Gate	Drain	Source

## Absolute Maximum Ratings

Symbol	Parameter	Max.	Units
$I_D @ T_C = 25^\circ\text{C}$	Continuous Drain Current, $V_{GS} @ 10\text{V}$	104	A
$I_D @ T_C = 100^\circ\text{C}$	Continuous Drain Current, $V_{GS} @ 10\text{V}$	74	
$I_{DM}$	Pulsed Drain Current ①	420	
$P_D @ T_C = 25^\circ\text{C}$	Maximum Power Dissipation	380	W
	Linear Derating Factor	2.5	W/°C
$V_{GS}$	Gate-to-Source Voltage	$\pm 20$	V
$dv/dt$	Peak Diode Recovery ③	18	V/ns
$T_J$ $T_{STG}$	Operating Junction and Storage Temperature Range	-55 to + 175	°C
	Soldering Temperature, for 10 seconds (1.6mm from case)	300	
	Mounting torque, 6-32 or M3 screw	10lbf·in (1.1N·m)	

## Avalanche Characteristics

$E_{AS}$ (Thermally limited)	Single Pulse Avalanche Energy ②	220	mJ
$I_{AR}$	Avalanche Current ①	See Fig. 14, 15, 22a, 22b	A
$E_{AR}$	Repetitive Avalanche Energy ①		mJ

## Thermal Resistance

Symbol	Parameter	Typ.	Max.	Units
$R_{\theta JC}$	Junction-to-Case ⑦	—	0.40	°C/W
$R_{\theta CS}$	Case-to-Sink, Flat Greased Surface	0.50	—	
$R_{\theta JA}$	Junction-to-Ambient	—	62	

**Static @ T<sub>J</sub> = 25°C (unless otherwise specified)**

Symbol	Parameter	Min.	Typ.	Max.	Units	Conditions
V <sub>(BR)DSS</sub>	Drain-to-Source Breakdown Voltage	150	—	—	V	V <sub>GS</sub> = 0V, I <sub>D</sub> = 250μA
ΔV <sub>(BR)DSS</sub> /ΔT <sub>J</sub>	Breakdown Voltage Temp. Coefficient	—	0.18	—	V/°C	Reference to 25°C, I <sub>D</sub> = 3.5mA <sup>①</sup>
R <sub>DS(on)</sub>	Static Drain-to-Source On-Resistance	—	9.3	11	mΩ	V <sub>GS</sub> = 10V, I <sub>D</sub> = 62A <sup>④</sup>
V <sub>GS(th)</sub>	Gate Threshold Voltage	3.0	—	5.0	V	V <sub>DS</sub> = V <sub>GS</sub> , I <sub>D</sub> = 250μA
I <sub>DSS</sub>	Drain-to-Source Leakage Current	—	—	20	μA	V <sub>DS</sub> = 150V, V <sub>GS</sub> = 0V
		—	—	250		V <sub>DS</sub> = 150V, V <sub>GS</sub> = 0V, T <sub>J</sub> = 125°C
I <sub>GSS</sub>	Gate-to-Source Forward Leakage	—	—	100	nA	V <sub>GS</sub> = 20V
	Gate-to-Source Reverse Leakage	—	—	-100		V <sub>GS</sub> = -20V
R <sub>G</sub>	Internal Gate Resistance	—	2.3	—	Ω	

**Dynamic @ T<sub>J</sub> = 25°C (unless otherwise specified)**

Symbol	Parameter	Min.	Typ.	Max.	Units	Conditions
gfs	Forward Transconductance	97	—	—	S	V <sub>DS</sub> = 50V, I <sub>D</sub> = 62A
Q <sub>g</sub>	Total Gate Charge	—	77	120	nC	I <sub>D</sub> = 62A
Q <sub>gs</sub>	Gate-to-Source Charge	—	28	—		V <sub>DS</sub> = 75V
Q <sub>gd</sub>	Gate-to-Drain ("Miller") Charge	—	26	—		V <sub>GS</sub> = 10V <sup>④</sup>
Q <sub>sync</sub>	Total Gate Charge Sync. (Q <sub>g</sub> - Q <sub>gd</sub> )	—	51	—		I <sub>D</sub> = 62A, V <sub>DS</sub> = 0V, V <sub>GS</sub> = 10V
t <sub>d(on)</sub>	Turn-On Delay Time	—	18	—	ns	V <sub>DD</sub> = 98V
t <sub>r</sub>	Rise Time	—	73	—		I <sub>D</sub> = 62A
t <sub>d(off)</sub>	Turn-Off Delay Time	—	41	—		R <sub>G</sub> = 2.2Ω
t <sub>f</sub>	Fall Time	—	39	—		V <sub>GS</sub> = 10V <sup>④</sup>
C <sub>iss</sub>	Input Capacitance	—	5270	—	pF	V <sub>GS</sub> = 0V
C <sub>oss</sub>	Output Capacitance	—	490	—		V <sub>DS</sub> = 50V
C <sub>rss</sub>	Reverse Transfer Capacitance	—	105	—		f = 1.0 MHz, See Fig. 5
C <sub>oss eff. (ER)</sub>	Effective Output Capacitance (Energy Related)	—	460	—		V <sub>GS</sub> = 0V, V <sub>DS</sub> = 0V to 120V <sup>⑥</sup> , See Fig. 11
C <sub>oss eff. (TR)</sub>	Effective Output Capacitance (Time Related)	—	530	—		V <sub>GS</sub> = 0V, V <sub>DS</sub> = 0V to 120V <sup>⑤</sup>

**Diode Characteristics**

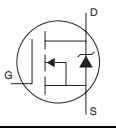
Symbol	Parameter	Min.	Typ.	Max.	Units	Conditions
I <sub>S</sub>	Continuous Source Current (Body Diode)	—	—	104	A	MOSFET symbol showing the integral reverse p-n junction diode. 
I <sub>SM</sub>	Pulsed Source Current (Body Diode) <sup>②</sup>	—	—	420	A	
V <sub>SD</sub>	Diode Forward Voltage	—	—	1.3	V	T <sub>J</sub> = 25°C, I <sub>S</sub> = 62A, V <sub>GS</sub> = 0V <sup>④</sup>
t <sub>rr</sub>	Reverse Recovery Time	—	86	—	ns	T <sub>J</sub> = 25°C V <sub>R</sub> = 130V, T <sub>J</sub> = 125°C I <sub>F</sub> = 62A
Q <sub>rr</sub>	Reverse Recovery Charge	—	300	—	nC	T <sub>J</sub> = 25°C di/dt = 100A/μs <sup>④</sup> T <sub>J</sub> = 125°C
I <sub>RRM</sub>	Reverse Recovery Current	—	6.5	—	A	T <sub>J</sub> = 25°C
t <sub>on</sub>	Forward Turn-On Time	Intrinsic turn-on time is negligible (turn-on is dominated by LS+LD)				

**Notes:**

- ① Repetitive rating; pulse width limited by max. junction temperature.
- ② Limited by T<sub>Jmax</sub>, starting T<sub>J</sub> = 25°C, L = 0.11mH  
R<sub>G</sub> = 25Ω, I<sub>AS</sub> = 62A, V<sub>GS</sub> = 10V. Part not recommended for use above this value.
- ③ I<sub>SD</sub> ≤ 62A, di/dt ≤ 1040A/μs, V<sub>DD</sub> ≤ V<sub>(BR)DSS</sub>, T<sub>J</sub> ≤ 175°C.
- ④ Pulse width ≤ 400μs; duty cycle ≤ 2%.

- ⑤ C<sub>oss eff. (TR)</sub> is a fixed capacitance that gives the same charging time as C<sub>oss</sub> while V<sub>DS</sub> is rising from 0 to 80% V<sub>DSS</sub>.
- ⑥ C<sub>oss eff. (ER)</sub> is a fixed capacitance that gives the same energy as C<sub>oss</sub> while V<sub>DS</sub> is rising from 0 to 80% V<sub>DSS</sub>.
- ⑦ R<sub>θ</sub> is measured at T<sub>J</sub> approximately 90°C.

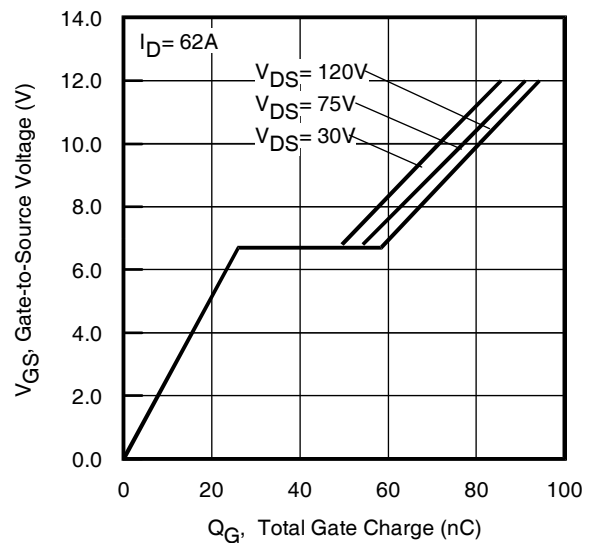
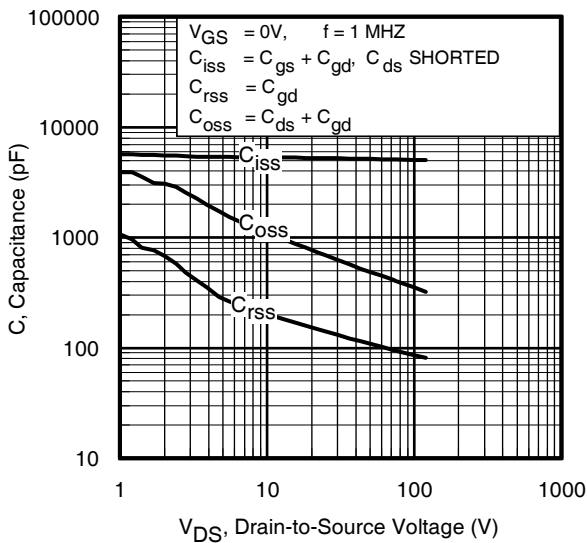
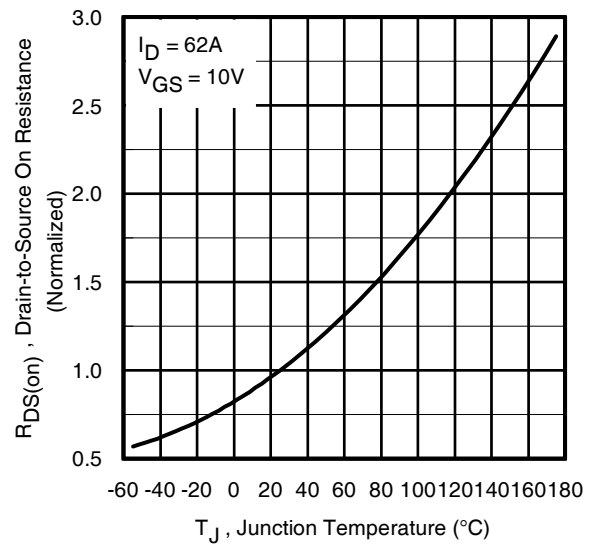
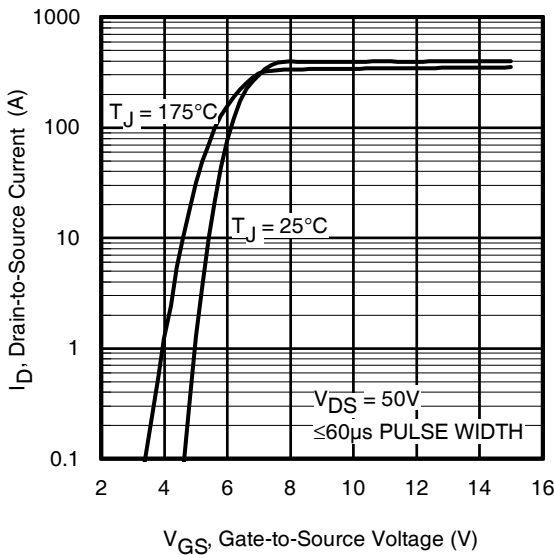
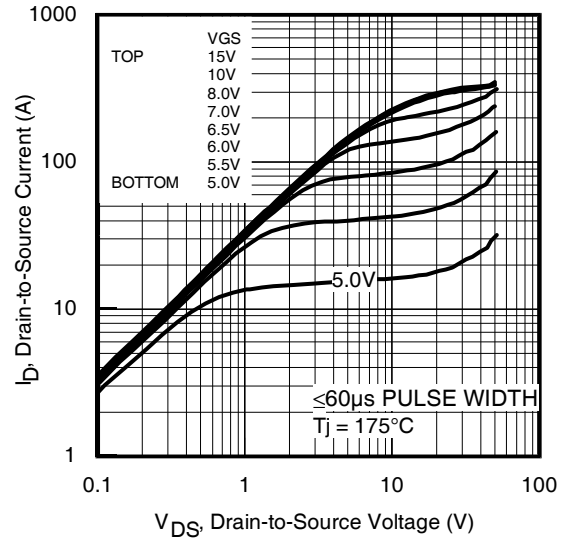
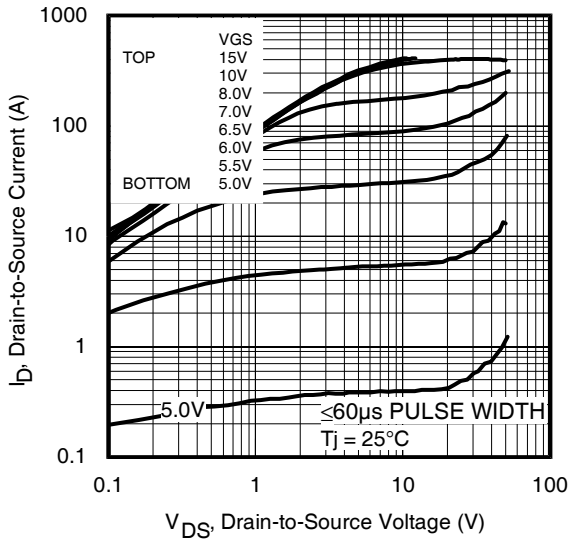
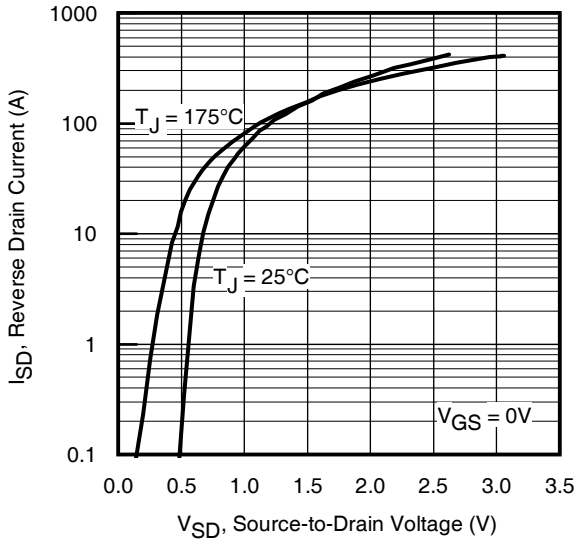
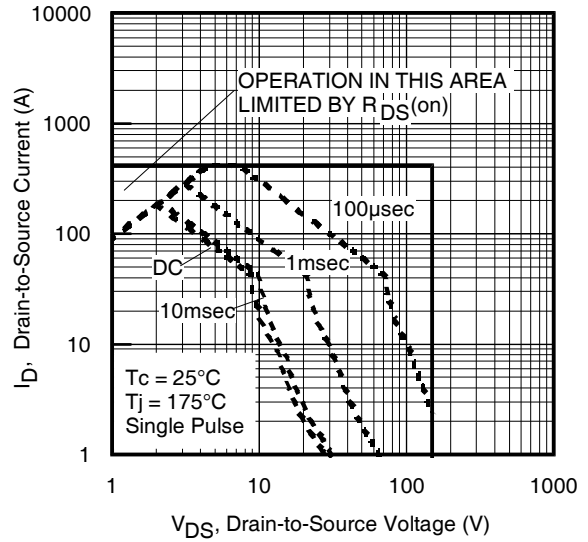

Fig 5. Typical Capacitance vs. Drain-to-Source Voltage

Fig 6. Typical Gate Charge vs. Gate-to-Source Voltage



**Fig 7.** Typical Source-Drain Diode Forward Voltage



**Fig 8.** Maximum Safe Operating Area

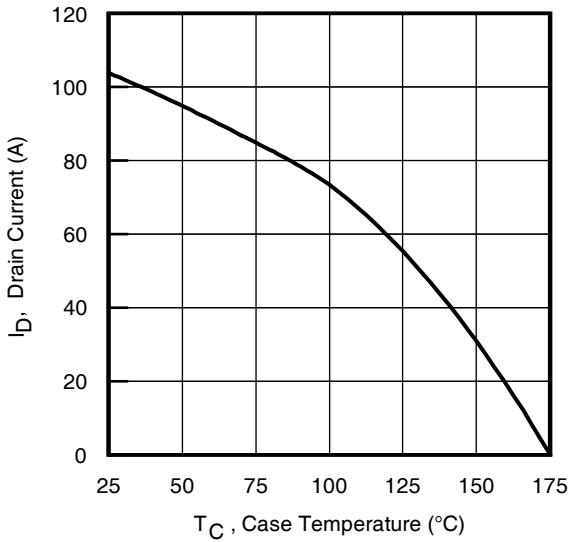

**Fig 9.** Maximum Drain Current vs. Case Temperature

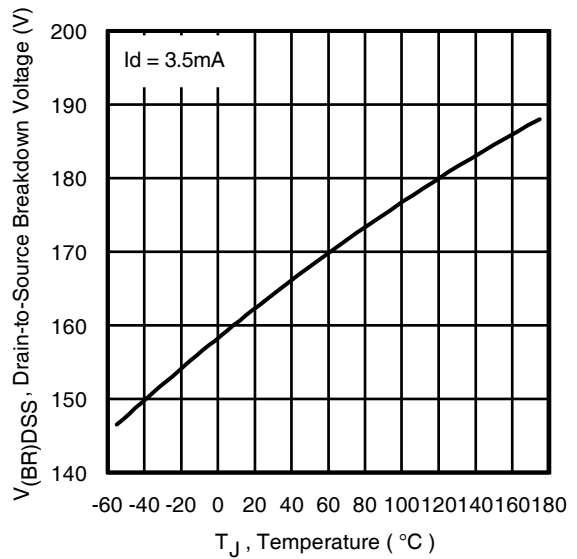

**Fig 10.** Drain-to-Source Breakdown Voltage

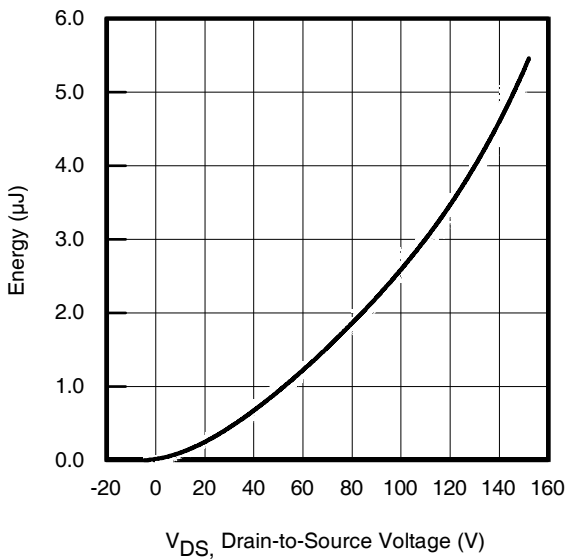

**Fig 11.** Typical  $C_{OSS}$  Stored Energy

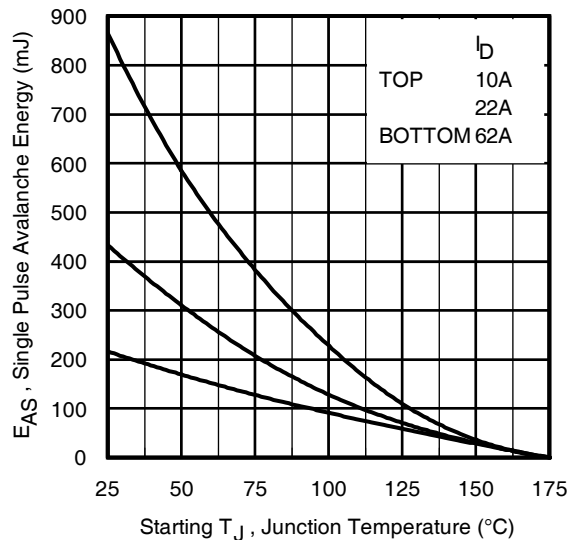

**Fig 12.** Maximum Avalanche Energy vs. Drain Current

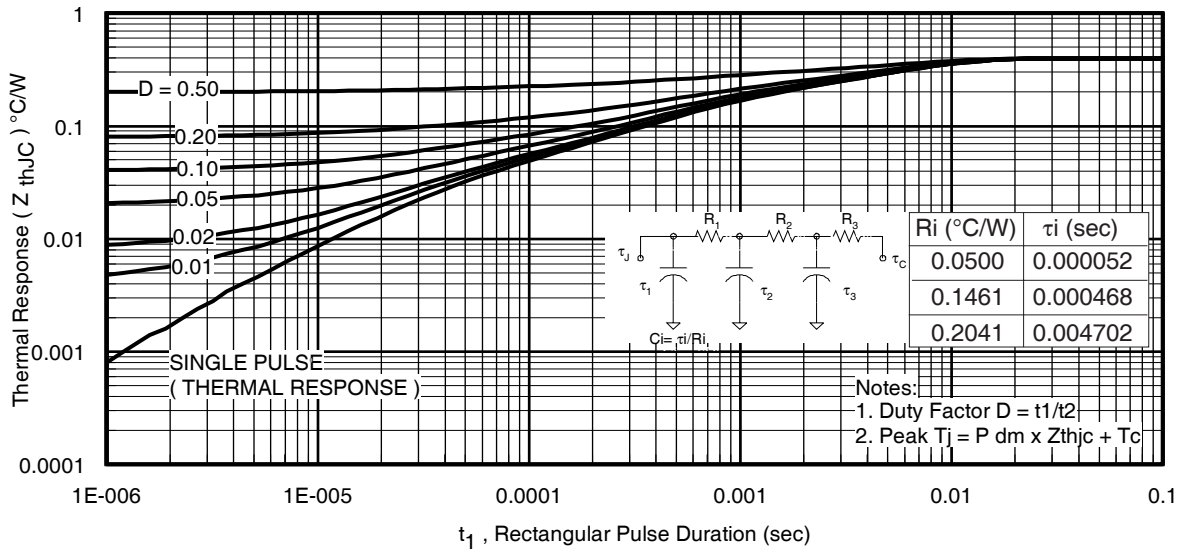

Fig 13. Maximum Effective Transient Thermal Impedance, Junction-to-Case

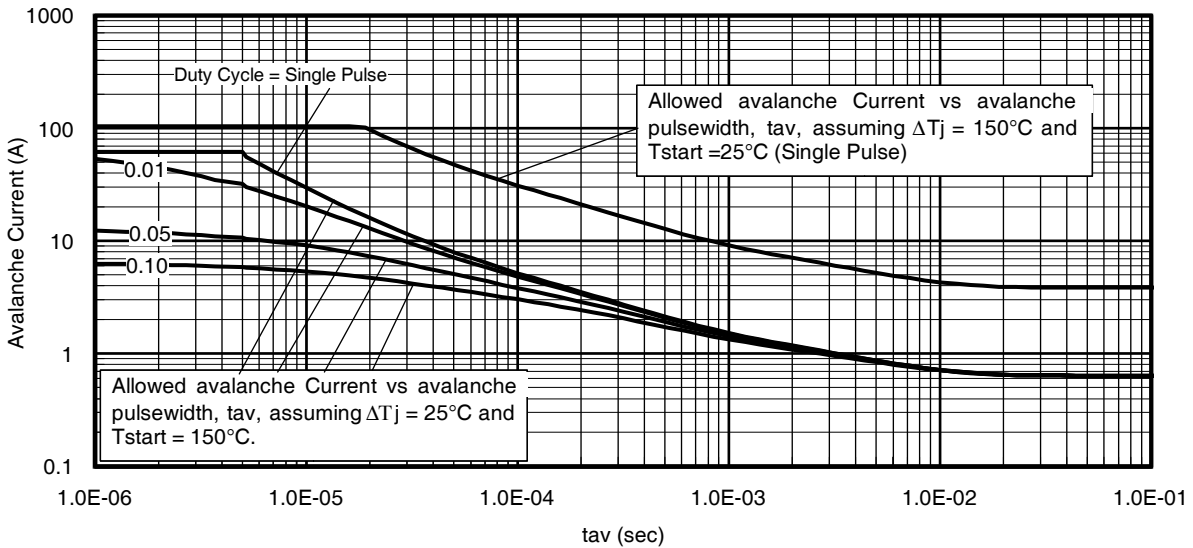

Fig 14. Typical Avalanche Current vs. Pulsewidth

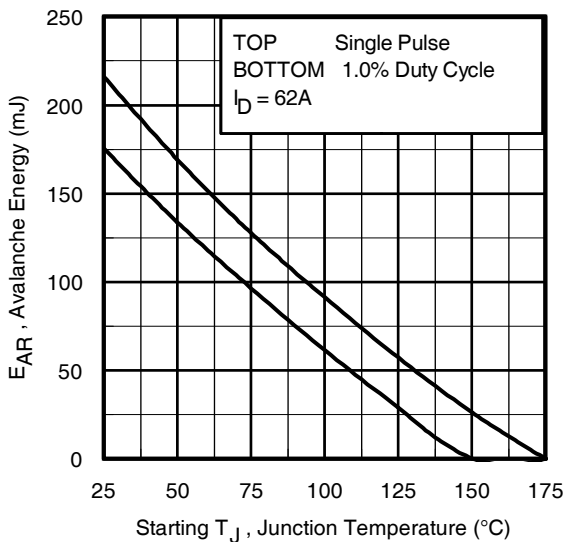

Fig 15. Maximum Avalanche Energy vs. Temperature

Notes on Repetitive Avalanche Curves, Figures 14, 15:  
(For further info, see AN-1005 at [www.irf.com](http://www.irf.com))

1. Avalanche failures assumption:  
Purely a thermal phenomenon and failure occurs at a temperature far in excess of  $T_{jmax}$ . This is validated for every part type.
2. Safe operation in Avalanche is allowed as long as  $T_{jmax}$  is not exceeded.
3. Equation below based on circuit and waveforms shown in Figures 16a, 16b.
4.  $P_{D(ave)}$  = Average power dissipation per single avalanche pulse.
5.  $BV$  = Rated breakdown voltage (1.3 factor accounts for voltage increase during avalanche).
6.  $I_{av}$  = Allowable avalanche current.
7.  $\Delta T$  = Allowable rise in junction temperature, not to exceed  $T_{jmax}$  (assumed as  $25^\circ\text{C}$  in Figure 14, 15).  
 $t_{av}$  = Average time in avalanche.  
 $D$  = Duty cycle in avalanche =  $t_{av} \cdot f$   
 $Z_{thjc}(D, t_{av})$  = Transient thermal resistance, see Figures 13)

$$P_{D(ave)} = 1/2 (1.3 \cdot BV \cdot I_{av}) = \Delta T / Z_{thjc}$$

$$I_{av} = 2\Delta T / [1.3 \cdot BV \cdot Z_{thj}]$$

$$E_{AS(AR)} = P_{D(ave)} \cdot t_{av}$$

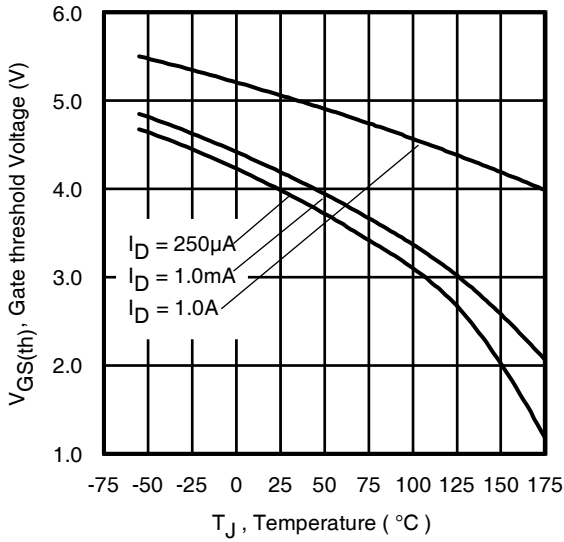

Fig 16. Threshold Voltage vs. Temperature

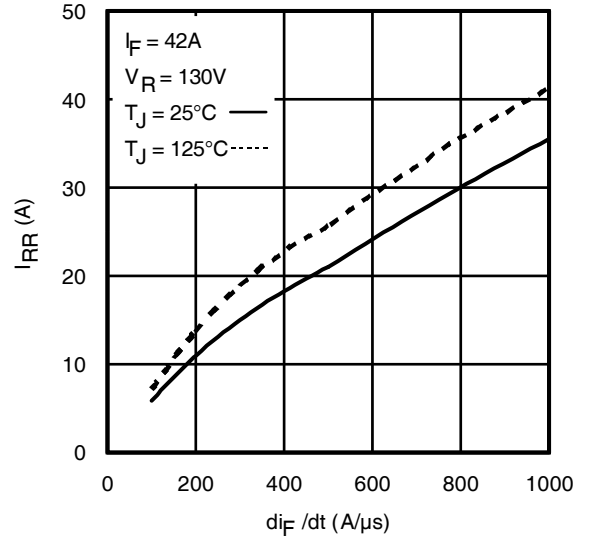

Fig. 17 - Typical Recovery Current vs.  $di_F/dt$

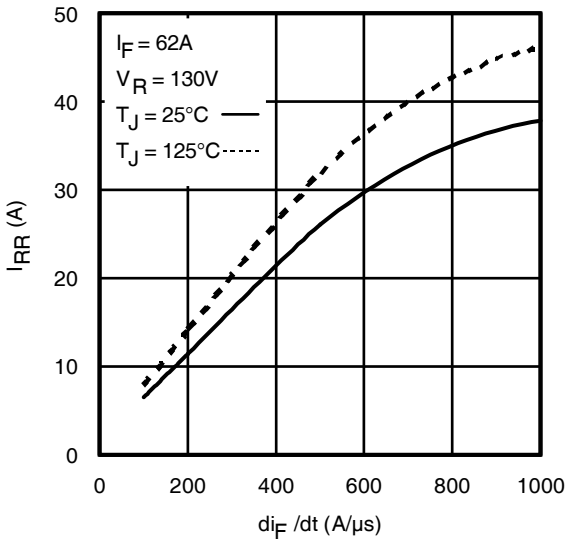

Fig. 18 - Typical Recovery Current vs.  $di_F/dt$

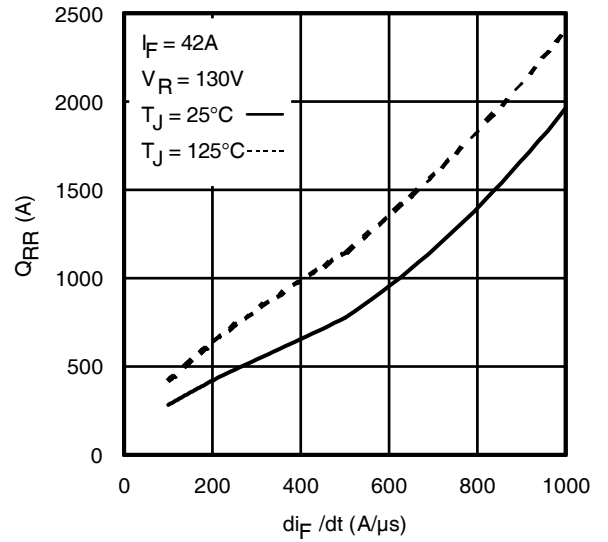

Fig. 19 - Typical Stored Charge vs.  $di_F/dt$

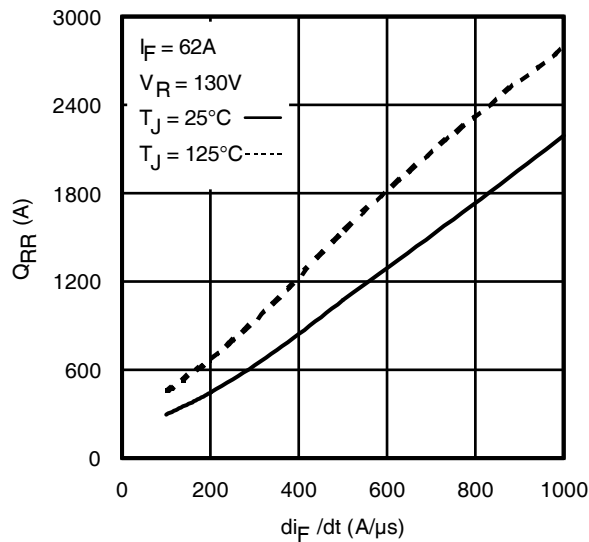

Fig. 20 - Typical Stored Charge vs.  $di_F/dt$



**Fig 21. Peak Diode Recovery dv/dt Test Circuit for N-Channel HEXFET® Power MOSFETs**



\*  $V_{GS} = 5V$  for Logic Level Devices



**Fig 22a. Unclamped Inductive Test Circuit**



**Fig 22b. Unclamped Inductive Waveforms**



**Fig 23a. Switching Time Test Circuit**



**Fig 23b. Switching Time Waveforms**



**Fig 24a. Gate Charge Test Circuit**



**Fig 24b. Gate Charge Waveform**

TO-220AB Package Outline

Dimensions are shown in millimeters (inches)

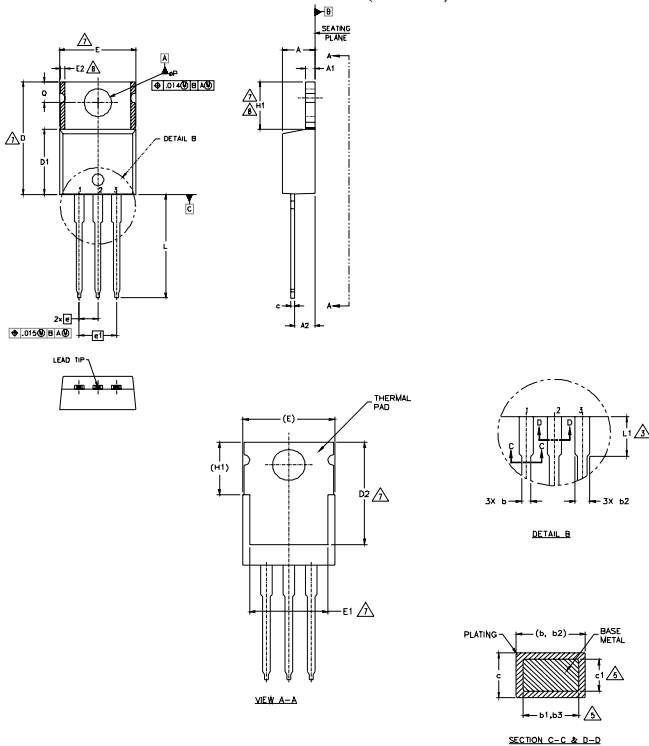

NOTES:

- 1.- DIMENSIONING AND TOLERANCING AS PER ASME Y14.5 M- 1994.
- 2.- DIMENSIONS ARE SHOWN IN INCHES [MILLIMETERS].
- 3.- LEAD DIMENSION AND FINISH UNCONTROLLED IN L1.
- 4.- DIMENSION D, D1 & E DO NOT INCLUDE MOLD FLASH. MOLD FLASH SHALL NOT EXCEED .005" (0.127) PER SIDE. THESE DIMENSIONS ARE MEASURED AT THE OUTERMOST EXTREMES OF THE PLASTIC BODY.
- 5.- DIMENSION b1, b3 & c1 APPLY TO BASE METAL ONLY.
- 6.- CONTROLLING DIMENSION : INCHES.
- 7.- THERMAL PAD CONTOUR OPTIONAL WITHIN DIMENSIONS E,H1,D2 & E1
- 8.- DIMENSION E2 X H1 DEFINE A ZONE WHERE STAMPING AND SINGULATION IRREGULARITIES ARE ALLOWED.
- 9.- OUTLINE CONFORMS TO JEDEC TO-220, EXCEPT A2 (max.) AND D2 (min.) WHERE DIMENSIONS ARE DERIVED FROM THE ACTUAL PACKAGE OUTLINE.

SYMBOL	DIMENSIONS				NOTES
	MILLIMETERS		INCHES		
	MIN.	MAX.	MIN.	MAX.	
A	3.56	4.83	.140	.190	
A1	0.51	1.40	.020	.055	
A2	2.03	2.92	.080	.115	
b	0.38	1.01	.015	.040	
b1	0.38	0.97	.015	.038	5
b2	1.14	1.78	.045	.070	
b3	1.14	1.73	.045	.068	5
c	0.36	0.61	.014	.024	
c1	0.36	0.56	.014	.022	5
D	14.22	16.51	.560	.650	4
D1	8.38	9.02	.330	.355	
D2	11.68	12.88	.460	.507	7
E	9.65	10.67	.380	.420	4,7
E1	6.86	8.89	.270	.350	7
E2	-	0.76	-	.030	8
e	2.54 BSC		.100 BSC		
e1	5.08 BSC		.200 BSC		
H1	5.84	6.86	.230	.270	7,8
L	12.70	14.73	.500	.580	
L1	3.56	4.06	.140	.160	3
øP	3.54	4.08	.139	.161	
Q	2.54	3.42	.100	.135	

LEAD ASSIGNMENTS

HEXFET

- 1.- GATE
- 2.- DRAIN
- 3.- SOURCE

IGBTs, CoPACK

- 1.- GATE
- 2.- COLLECTOR
- 3.- EMITTER

DIODES

- 1.- ANODE
- 2.- CATHODE
- 3.- ANODE

TO-220AB Part Marking Information

EXAMPLE: THIS IS AN IRFB4310GPBF

Note: "G" suffix in part number indicates "Halogen - Free"

Note: "P" in assembly line position indicates "Lead - Free"

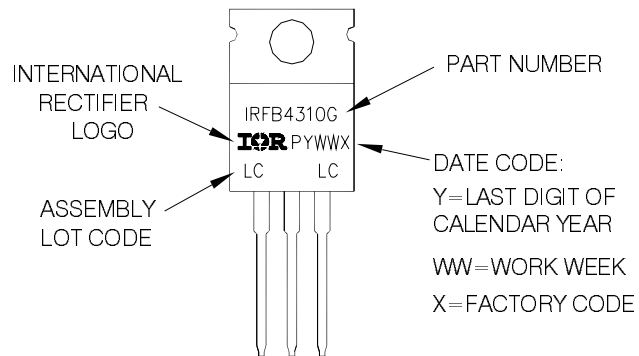

TO-220AB packages are not recommended for Surface Mount Application.

Note: For the most current drawing please refer to IR website at: <http://www.irf.com/package/>

Data and specifications subject to change without notice. This product has been designed and qualified for the Industrial market. Qualification Standards can be found on IR's Web site.