

## NC7S32 TinyLogic® HS 2-Input OR Gate

### General Description

The NC7S32 is a single 2-Input high performance CMOS OR Gate. Advanced Silicon Gate CMOS fabrication assures high speed and low power circuit operation over a broad  $V_{CC}$  range. ESD protection diodes inherently guard both inputs and output with respect to the  $V_{CC}$  and GND rails. Three stages of gain between inputs and outputs assures high noise immunity and reduced sensitivity to input edge rate.

### Features

- Space saving SOT23 or SC70 5-lead package
- Ultra small MicroPak™ leadless package
- High Speed;  $t_{PD}$  3.5 ns typ
- Low Quiescent Power;  $I_{CC} < 1 \mu A$
- Balanced Output Drive; 2 mA  $I_{OL}$ , -2 mA  $I_{OH}$
- Broad  $V_{CC}$  Operating Range: 2V-6V
- Balanced Propagation Delays
- Specified for 3V Operation

### Ordering Code:

Order Number	Package Number	Product Code Top Mark	Package Description	Supplied As
NC7S32M5X	MA05B	7S32	5-Lead SOT23, JEDEC MO-178, 1.6mm	3k Units on Tape and Reel
NC7S32P5X	MAA05A	S32	5-Lead SC70, EIAJ SC-88a, 1.25mm Wide	3k Units on Tape and Reel
NC7S32L6X	MAC06A	TT	6-Lead MicroPak, 1.0mm Wide	5k Units on Tape and Reel

### Logic Symbol

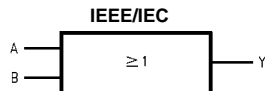

### Pin Descriptions

Pin Names	Description
A, B	Inputs
Y	Output
NC	No Connect

### Function Table

$$Y = A + B$$

Inputs		Output
A	B	Y
L	L	L
L	H	H
H	L	H
H	H	H

H = HIGH Logic Level  
L = LOW Logic Level

TinyLogic® is a registered trademark of Fairchild Semiconductor Corporation.  
MicroPak™ is a trademark of Fairchild Semiconductor Corporation.

### Connection Diagrams

#### Pin Assignments for SC70 and SOT23

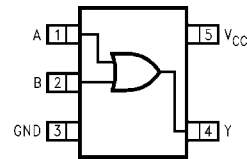

(Top View)

#### Pad Assignments for MicroPak

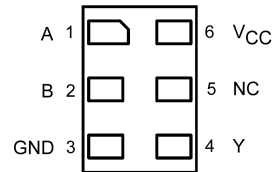

(Top Thru View)

### Absolute Maximum Ratings (Note 1)

Supply Voltage ( $V_{CC}$ )	-0.5V to +7.0V
DC Input Diode Current ( $I_{IK}$ )	
@ $V_{IN} \leq -0.5V$	-20 mA
@ $V_{IN} \geq V_{CC} + 0.5V$	+20 mA
DC Input Voltage ( $V_{IN}$ )	-0.5V to $V_{CC} + 0.5V$
DC Output Diode Current ( $I_{OK}$ )	
@ $V_{OUT} < -0.5V$	-20 mA
@ $V_{OUT} > V_{CC} + 0.5V$	+20 mA
DC Output Voltage ( $V_{OUT}$ )	-0.5V to $V_{CC} + 0.5V$
DC Output Source or Sink Current ( $I_{OUT}$ )	$\pm 12.5$ mA
DC $V_{CC}$ or Ground Current per Output Pin ( $I_{CC}$ or $I_{GND}$ )	$\pm 25$ mA
Storage Temperature ( $T_{STG}$ )	-65°C to +150°C
Junction Temperature ( $T_J$ )	150°C
Lead Temperature ( $T_L$ ) (Soldering, 10 seconds)	260°C
Power Dissipation ( $P_D$ ) @ +85°C	
SOT23-5	200 mW
SC70-5	150 mW

### Recommended Operating Conditions (Note 2)

Supply Voltage ( $V_{CC}$ )	2.0V to 6.0V
Input Voltage ( $V_{IN}$ )	0V to $V_{CC}$
Output Voltage ( $V_{OUT}$ )	0V to $V_{CC}$
Operating Temperature ( $T_A$ )	-40°C to +85°C
Input Rise and Fall Time ( $t_r, t_f$ )	
$V_{CC}$ @ 2.0V	0 to 1000 ns
$V_{CC}$ @ 3.0V	0 to 750 ns
$V_{CC}$ @ 4.5V	0 to 500 ns
$V_{CC}$ @ 6.0V	0 to 400 ns
Thermal Resistance ( $\theta_{JA}$ )	
SOT23-5	300°C/W
SC70-5	425°C/W

**Note 1:** Absolute maximum ratings are those values beyond which damage to the device may occur. The databook specifications should be met, without exception, to ensure that the system design is reliable over its power supply, temperature, and output/input loading variables. Fairchild does not recommend operation of circuits outside the databook specifications.

**Note 2:** Unused inputs must be held HIGH or LOW. They may not float.

### DC Electrical Characteristics

Symbol	Parameter	$V_{CC}$ (V)	$T_A = +25^\circ\text{C}$			$T_A = -40^\circ\text{C to } +85^\circ\text{C}$		Units	Condition	
			Min	Typ	Max	Min	Max			
$V_{IH}$	HIGH Level Input Voltage	2.0	1.50			1.50		V		
		3.0-6.0	0.7 $V_{CC}$			0.7 $V_{CC}$				
$V_{IL}$	LOW Level Input Voltage	2.0		0.50		0.50		V		
		3.0-6.0	0.3 $V_{CC}$			0.3 $V_{CC}$				
$V_{OH}$	HIGH Level Output Voltage	2.0	1.90	2.0		1.90		V	$I_{OH} = -20 \mu\text{A}$ $V_{IN} = V_{IH}$	
		3.0	2.90	3.0		2.90				
		4.5	4.40	4.5		4.40				
		6.0	5.90	6.0		5.90				
			3.0	2.68	2.85		2.63		V	$V_{IN} = V_{IH}$ $I_{OH} = -1.3 \text{ mA}$ $I_{OH} = -2 \text{ mA}$ $I_{OH} = -2.6 \text{ mA}$
			4.5	4.18	4.35		4.13			
			6.0	5.68	5.85		5.63			
$V_{OL}$	LOW Level Output Voltage	2.0		0.0	0.10		0.10	V	$I_{OL} = 20 \mu\text{A}$ $V_{IN} = V_{IL}$	
		3.0		0.0	0.10		0.10			
		4.5		0.0	0.10		0.10			
		6.0		0.0	0.10		0.10			
			3.0		0.1	0.26		0.33	V	$V_{IN} = V_{IL}$ $I_{OL} = 1.3 \text{ mA}$ $I_{OL} = 2 \text{ mA}$ $I_{OL} = 2.6 \text{ mA}$
			4.5		0.1	0.26		0.33		
			6.0		0.1	0.26		0.33		
$I_{IN}$	Input Leakage Current	6.0		$\pm 0.1$		$\pm 1.0$	$\mu\text{A}$	$V_{IN} = V_{CC}, \text{ GND}$		
$I_{CC}$	Quiescent Supply Current	6.0		1.0		10.0	$\mu\text{A}$	$V_{IN} = V_{CC}, \text{ GND}$		

## AC Electrical Characteristics

Symbol	Parameter	V <sub>CC</sub> (V)	T <sub>A</sub> = +25°C			T <sub>A</sub> = -40°C to +85°C		Units	Conditions	Figure Number
			Min	Typ	Max	Min	Max			
t <sub>PLH</sub>	Propagation Delay	5.0		3.5	15			ns	C <sub>L</sub> = 15 pF	Figures 1, 3
t <sub>PHL</sub>		2.0		20	100		125	ns	C <sub>L</sub> = 50 pF	
		3.0		12	27		35			
		4.5		8	20		25			
		6.0		7	17		21			
t <sub>TLH</sub>	Output Transition Time	5.0		3.0	10			ns	C <sub>L</sub> = 15 pF	Figures 1, 3
t <sub>THL</sub>		2.0		25	125		155	ns	C <sub>L</sub> = 50 pF	
		3.0		16	35		45			
		4.5		11	25		31			
		6.0		9	21		26			
C <sub>IN</sub>	Input Capacitance	Open		2	10		10	pF		
C <sub>PD</sub>	Power Dissipation Capacitance	5.0		6				pF	(Note 3)	Figure 2

**Note 3:** C<sub>PD</sub> is defined as the value of the internal equivalent capacitance which is derived from dynamic operating current consumption (I<sub>CCD</sub>) at no output loading and operating at 50% duty cycle. (See Figure 2) C<sub>PD</sub> is related to I<sub>CCD</sub> dynamic operating current by the expression:  
 $I_{CCD} = (C_{PD})(V_{CC})(f_{IN}) + (I_{CCstatic})$ .

## AC Loading and Waveforms

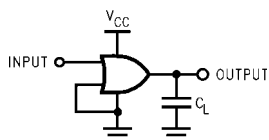

C<sub>L</sub> includes load and stray capacitance  
 Input PRR = 1.0 MHz, t<sub>w</sub> = 500 ns

**FIGURE 1. AC Test Circuit**

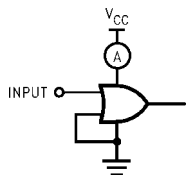

Input = AC Waveforms;  
 PRR = variable; Duty Cycle = 50%

**FIGURE 2. I<sub>CCD</sub> Test Circuit**

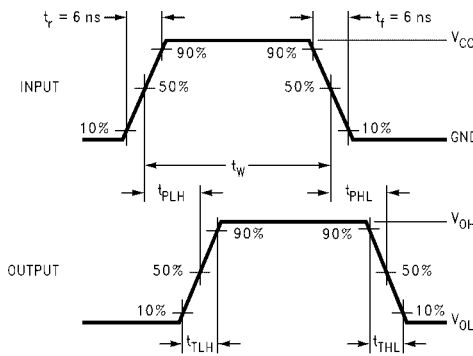

**FIGURE 3. AC Waveforms**

## Tape and Reel Specification

### TAPE FORMAT for SC70 and SOT23

Package Designator	Tape Section	Number Cavities	Cavity Status	Cover Tape Status
M5X, P5X	Leader (Start End)	125 (typ)	Empty	Sealed
	Carrier	3000	Filled	Sealed
	Trailer (Hub End)	75 (typ)	Empty	Sealed

### TAPE DIMENSIONS inches (millimeters)



Package	Tape Size	DIM A	DIM B	DIM F	DIM $K_o$	DIM P1	DIM W
SC70-5	8 mm	0.093 (2.35)	0.096 (2.45)	0.138 ± 0.004 (3.5 ± 0.10)	0.053 ± 0.004 (1.35 ± 0.10)	0.157 (4)	0.315 ± 0.004 (8 ± 0.1)
SOT23-5	8 mm	0.130 (3.3)	0.130 (3.3)	0.138 ± 0.002 (3.5 ± 0.05)	0.055 ± 0.004 (1.4 ± 0.11)	0.157 (4)	0.315 ± 0.012 (8 ± 0.3)

Tape and Reel Specification (Continued)								
TAPE FORMAT for MicroPak								
Package Designator	Tape Section		Number Cavities	Cavity Status	Cover Tape Status			
L6X	Leader (Start End)		125 (typ)	Empty	Sealed			
	Carrier		5000	Filled	Sealed			
	Trailer (Hub End)		75 (typ)	Empty	Sealed			

**SECTION B-B**  
SCALE: 10X

**SECTION A-A**  
SCALE: 10X

**REEL DIMENSIONS** inches (millimeters)

**DETAIL X**

**DETAIL X**  
SCALE: 3X

Tape Size	A	B	C	D	N	W1	W2	W3
8 mm	7.0 (177.8)	0.059 (1.50)	0.512 (13.00)	0.795 (20.20)	2.165 (55.00)	0.331 +0.059/-0.000 (8.40 +1.50/-0.00)	0.567 (14.40)	W1 +0.078/-0.039 (W1 +2.00/-1.00)

**Physical Dimensions** inches (millimeters) unless otherwise noted



LAND PATTERN RECOMMENDATION



DETAIL A

NOTES: UNLESS OTHERWISE SPECIFIED

- A) THIS PACKAGE CONFORMS TO JEDEC MO-178, ISSUE B, VARIATION AA, DATED JANUARY 1999.
- B) ALL DIMENSIONS ARE IN MILLIMETERS.

MA05BRevC

5-Lead SOT23, JEDEC MO-178, 1.6mm  
Package Number MA05B

**Physical Dimensions** inches (millimeters) unless otherwise noted (Continued)

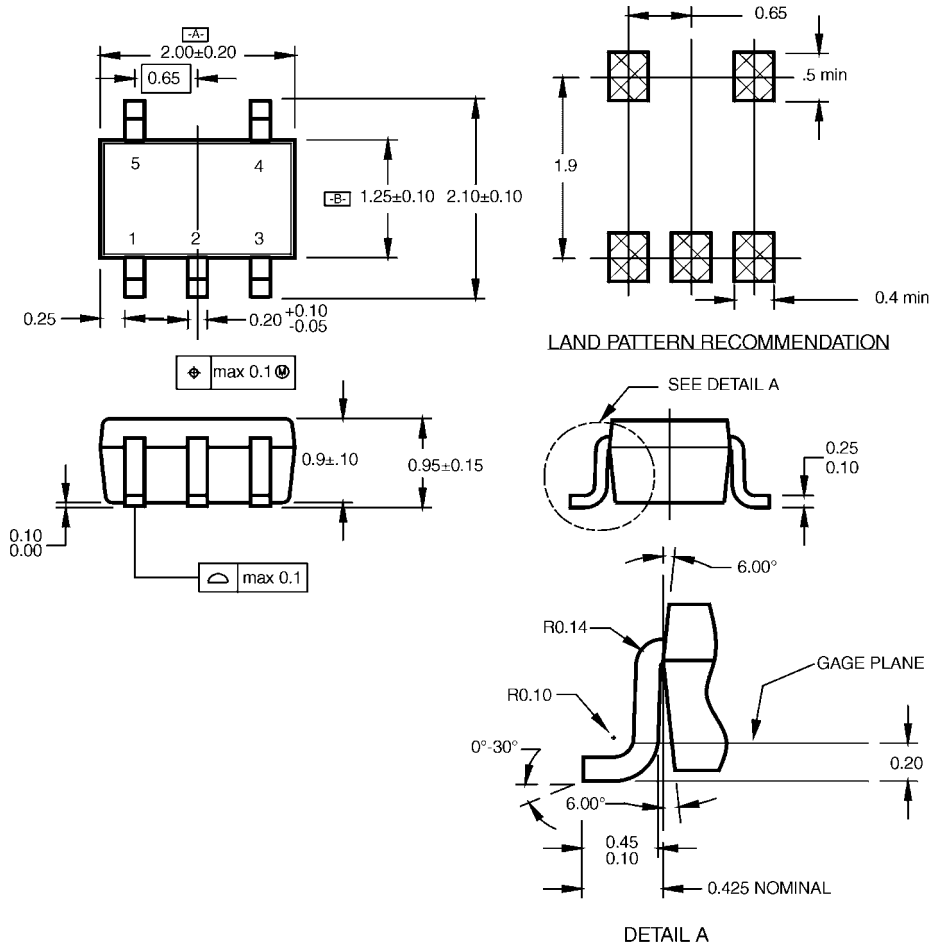

NOTES:

- A. CONFORMS TO EIAJ REGISTERED OUTLINE DRAWING SC88A.
- B. DIMENSIONS DO NOT INCLUDE BURRS OR MOLD FLASH.
- C. DIMENSIONS ARE IN MILLIMETERS.

MAA05ARevC

**5-Lead SC70, EIAJ SC-88a, 1.25mm Wide  
Package Number MAA05A**

**Physical Dimensions** inches (millimeters) unless otherwise noted (Continued)



**Notes:**

1. JEDEC PACKAGE REGISTRATION IS ANTICIPATED
2. DIMENSIONS ARE IN MILLIMETERS
3. DRAWING CONFORMS TO ASME Y14.5M-1994

MAC06ARevB

**6-Lead MicroPak, 1.0mm Wide  
Package Number MAC06A**

Fairchild does not assume any responsibility for use of any circuitry described, no circuit patent licenses are implied and Fairchild reserves the right at any time without notice to change said circuitry and specifications.

**LIFE SUPPORT POLICY**

FAIRCHILD'S PRODUCTS ARE NOT AUTHORIZED FOR USE AS CRITICAL COMPONENTS IN LIFE SUPPORT DEVICES OR SYSTEMS WITHOUT THE EXPRESS WRITTEN APPROVAL OF THE PRESIDENT OF FAIRCHILD SEMICONDUCTOR CORPORATION. As used herein:

1. Life support devices or systems are devices or systems which, (a) are intended for surgical implant into the body, or (b) support or sustain life, and (c) whose failure to perform when properly used in accordance with instructions for use provided in the labeling, can be reasonably expected to result in a significant injury to the user.
2. A critical component in any component of a life support device or system whose failure to perform can be reasonably expected to cause the failure of the life support device or system, or to affect its safety or effectiveness.

[www.fairchildsemi.com](http://www.fairchildsemi.com)