



# WTV4FE-22162120A00

W4

MINIATURE PHOTOELECTRIC SENSORS

**SICK**  
Sensor Intelligence.



Illustration may differ

### Ordering information

Type	Part no.
WTV4FE-22162120A00	1119988

Other models and accessories → [www.sick.com/W4](http://www.sick.com/W4)



### Detailed technical data

#### Features

<b>Functional principle</b>	Photoelectric proximity sensor
<b>Functional principle detail</b>	Background suppression, V-optics
<b>Sensing range</b>	
Sensing range min.	2 mm
Sensing range max.	50 mm
Adjustable switching threshold for background suppression	15 mm ... 50 mm
Reference object	Object with 90% remission factor (complies with standard white according to DIN 5033)
Minimum distance between set sensing range and background (black 6% / white 90%)	1 mm, at a distance of 21 mm
Recommended sensing range for the best performance	15 mm ... 30 mm
<b>Emitted beam</b>	
Light source	PinPoint LED
Type of light	Visible red light
Shape of light spot	Rectangular
Light spot size (distance)	0.5 mm x 1.9 mm (30 mm)
Maximum dispersion of the emitted beam around the standardized transmission axis (squint angle)	< +/- 1.5° (at Ta = +23 °C)

<b>Key LED figures</b>		
Normative reference	EN 62471:2008-09   IEC 62471:2006, modified	
LED risk group marking	Free group	
Wave length	635 nm	
Average service life	100,000 h at $T_a = +25\text{ °C}$	
<b>Smallest detectable object (MDO) typ.</b>		0.1 mm (At 30 mm distance (object with 90% remission (complies with standard white according to DIN 5033)))
<b>Adjustment</b>		
Teach-Turn adjustment	BluePilot: For setting the sensing range	
IO-Link	For configuring the sensor parameters and Smart Task functions	
<b>Indication</b>		
LED blue	BluePilot: sensing range indicator	
LED green	Operating indicator Static on: power on Flashing: IO-Link mode	
LED yellow	Status of received light beam Static on: object present Static off: object not present	
<b>Special applications</b>		Detecting transparent objects

#### Safety-related parameters

<b>MTTF<sub>D</sub></b>	661 years
<b>DC<sub>avg</sub></b>	0 %
<b>T<sub>M</sub> (mission time)</b>	20 years (EN ISO 13849, rate of use: 60 %)

#### Communication interface

<b>IO-Link</b>	✓, IO-Link V1.1
Data transmission rate	COM2 (38,4 kBaud)
Cycle time	2.3 ms
Process data length	16 Bit
Process data structure	Bit 0 = switching signal Q <sub>L1</sub> Bit 1 = switching signal Q <sub>L2</sub> Bit 2 ... 15 = Current receiver level (live)
VendorID	26
DeviceID HEX	0x8002B3
DeviceID DEC	8389299
Compatible master port type	A
SIO mode support	Yes

#### Electrical data

<b>Supply voltage U<sub>B</sub></b>	10 V DC ... 30 V DC <sup>1)</sup>
<b>Ripple</b>	≤ 5 V <sub>pp</sub>
<b>Usage category</b>	DC-12 (According to EN 60947-5-2)

<sup>1)</sup> Limit values.

<sup>2)</sup> Signal transit time with resistive load in switching mode.

<sup>3)</sup> With light/dark ratio 1:1.

<sup>4)</sup> This switching output must not be connected to another output.

	DC-13 (According to EN 60947-5-2)
<b>Current consumption</b>	≤ 25 mA, without load. At $U_B = 24\text{ V}$
<b>Protection class</b>	III
<b>Digital output</b>	
Number	2 (Complementary)
Type	Push-pull: PNP/NPN
Signal voltage PNP HIGH/LOW	Approx. $U_B - 2.5\text{ V} / 0\text{ V}$
Signal voltage NPN HIGH/LOW	Approx. $U_B / < 2.5\text{ V}$
Output current $I_{max}$	≤ 100 mA
Circuit protection outputs	Reverse polarity protected Overcurrent protected Short-circuit protected
Response time	≤ 500 $\mu\text{s}$
Repeatability (response time)	150 $\mu\text{s}$ <sup>2)</sup>
Switching frequency	1,000 Hz <sup>3)</sup>
<b>Pin/Wire assignment</b>	
Function of pin 4/black (BK)	Digital output, dark switching, object present → output $\bar{Q}_{L1}$ LOW; IO-Link communication C <sup>4)</sup>
Function of pin 4/black (BK) – detail	The pin 4 function of the sensor can be configured, Additional possible settings via IO-Link
Function of pin 2/white (WH)	Digital output, light switching, object present → output $Q_{L1}$ HIGH <sup>4)</sup>
Function of pin 2/white (WH) – detail	The pin 2 function of the sensor can be configured, Additional possible settings via IO-Link

<sup>1)</sup> Limit values.

<sup>2)</sup> Signal transit time with resistive load in switching mode.

<sup>3)</sup> With light/dark ratio 1:1.

<sup>4)</sup> This switching output must not be connected to another output.

## Mechanical data

<b>Housing</b>	Rectangular
<b>Design detail</b>	Flat
<b>Dimensions (W x H x D)</b>	16 mm x 40.1 mm x 12.1 mm
<b>Connection</b>	Male connector M8, 4-pin
<b>Material</b>	
Housing	Plastic, VISTAL®
Front screen	Plastic, PMMA
Male connector	Plastic, VISTAL®
<b>Weight</b>	Approx. 30 g
<b>Maximum tightening torque of the fixing screws</b>	0.4 Nm

## Ambient data

<b>Enclosure rating</b>	IP66 (EN 60529) IP67 (EN 60529)
<b>Ambient operating temperature</b>	-40 °C ... +60 °C
<b>Ambient temperature, storage</b>	-40 °C ... +75 °C
<b>Typ. Ambient light immunity</b>	Artificial light: ≤ 50,000 lx Sunlight: ≤ 50,000 lx

<b>Shock resistance</b>	30 g, 11 ms (3 positive and 3 negative shocks along X, Y, Z axes, 18 total shocks (EN60068-2-27))
<b>Vibration resistance</b>	10 Hz ... 1,000 Hz (Amplitude 1 mm, 3 x 30 min (EN60068-2-6))
<b>Air humidity</b>	35 % ... 95 %, Relative humidity (no condensation)
<b>Electromagnetic compatibility (EMC)</b>	EN 60947-5-2
<b>Resistance to cleaning agent</b>	ECOLAB
<b>UL File No.</b>	NRKH.E181493 & NRKH7.E181493

### Smart Task

<b>Smart Task name</b>	Base logics
<b>Logic function</b>	Direct AND OR
<b>Timer function</b>	Deactivated On delay Off delay ON and OFF delay Impulse (one shot)
<b>Inverter</b>	Yes
<b>Switching frequency</b>	SIO Logic: 900 Hz <sup>1)</sup> IOL: 800 Hz <sup>2)</sup>
<b>Response time</b>	SIO Logic: 550 µs <sup>1)</sup> IOL: 600 µs <sup>2)</sup>
<b>Repeatability</b>	SIO Logic: 200 µs <sup>1)</sup> IOL: 250 µs <sup>2)</sup>
<b>Switching signal</b>	
Switching signal Q <sub>L1</sub>	Switching output
Switching signal $\bar{Q}_{L1}$	Switching output

<sup>1)</sup> Use of Smart Task functions without IO-Link communication (SIO mode).

<sup>2)</sup> Use of Smart Task functions with IO-Link communication function.

### Diagnosis

<b>Device temperature</b>	
Measuring range	Very cold, cold, moderate, warm, hot
<b>Device status</b>	Yes
<b>Detailed device status</b>	Yes
<b>Operating hour counter</b>	Yes
<b>Operating hours counter with reset function</b>	Yes
<b>Quality of teach</b>	Yes

### Classifications

<b>ECLASS 5.0</b>	27270904
<b>ECLASS 5.1.4</b>	27270904
<b>ECLASS 6.0</b>	27270904
<b>ECLASS 6.2</b>	27270904
<b>ECLASS 7.0</b>	27270904
<b>ECLASS 8.0</b>	27270904

<b>ECLASS 8.1</b>	27270904
<b>ECLASS 9.0</b>	27270904
<b>ECLASS 10.0</b>	27270904
<b>ECLASS 11.0</b>	27270904
<b>ECLASS 12.0</b>	27270903
<b>ETIM 5.0</b>	EC002719
<b>ETIM 6.0</b>	EC002719
<b>ETIM 7.0</b>	EC002719
<b>ETIM 8.0</b>	EC002719
<b>UNSPSC 16.0901</b>	39121528

## Adjustments

Display and adjustment elements

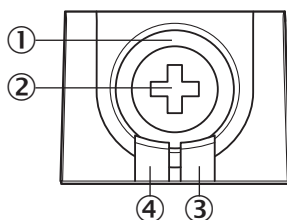

- ① LED blue
- ② Teach-Turn adjustment
- ③ LED yellow
- ④ LED green

## Installation note

Angle of acceptance, pane of glass in front of background,  $\beta$

Transparent pane of glass in front of background  
(18 % remission), angle of acceptance

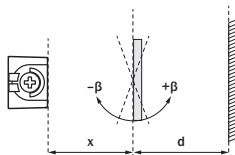
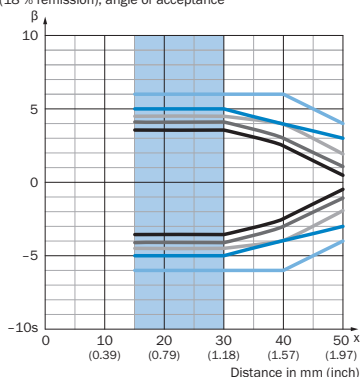

Example:  
Set sensing range  $x = 30$  mm  
Distance object to background  $d \geq 200$  mm  
Angle of acceptance between  $-6^\circ$  and  $+6^\circ$

- $d = 10$  mm
- $d = 40$  mm
- $d = 80$  mm
- $d = 120$  mm
- $d \geq 200$  mm
- Recommended sensing range for the best performance

### Angle of acceptance, pane of glass in front of background, $\alpha$

Transparent pane of glass in front of background  
(18 % remission), angle of acceptance

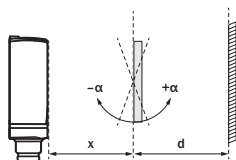
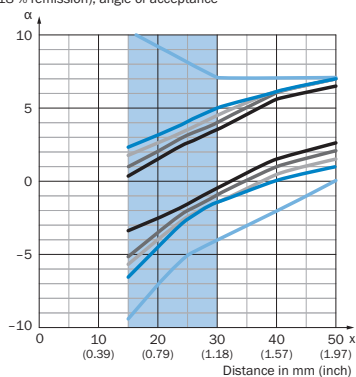

Example:  
Set sensing range  $x = 30$  mm  
Distance object to background  $d \geq 200$  mm  
Angle of acceptance between  $-4^\circ$  and  $+7^\circ$

- $d = 10$  mm
- $d = 40$  mm
- $d = 80$  mm
- $d = 120$  mm
- $d \geq 200$  mm
- Recommended sensing range for the best performance

### Angle of acceptance, on high-glossy object, $\beta$

High-glossy object, angle of acceptance

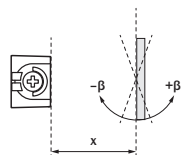
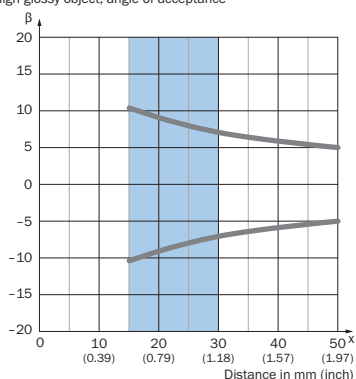

Example:  
Set sensing range  $x = 30$  mm  
Angle of acceptance between  $-7^\circ$  and  $+7^\circ$

- Recommended sensing range for the best performance

### Angle of acceptance, on high-glossy object, $\alpha$

High-glossy object, angle of acceptance

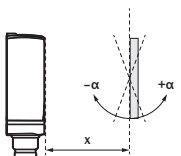
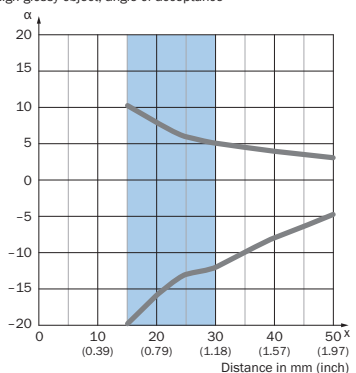

Example:  
Set sensing range  $x = 30$  mm  
Angle of acceptance between  $-12^\circ$  and  $+5^\circ$

- Recommended sensing range for the best performance

### Connection type

Male connector M8, 4-pin

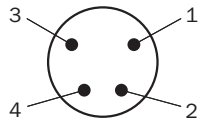

### Connection diagram

Cd-503

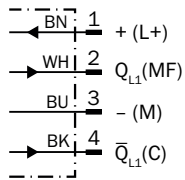

### Truth table

Push-pull: PNP/NPN – dark switching  $\bar{Q}$

	Dark switching $\bar{Q}$ (normally closed (upper switch), normally open (lower switch))	
	Object not present → Output HIGH	Object present → Output LOW
Light receive	✗	✓
Light receive indicator	✗	☀️
Load resistance to L+	✗	⚠️
Load resistance to M	⚠️	✗

Push-pull: PNP/NPN - light switching Q

	Light switching Q (normally open (upper switch), normally closed (lower switch))	
	Object not present → Output LOW	Object present → Output HIGH
Light receive	✗	✓
Light receive indicator	✗	☀️
Load resistance to L+	⚠️	✗
Load resistance to M	✗	⚠️



## Characteristic curve

Minimum distance in mm (y) between the set sensing range and white background (90 % remission)

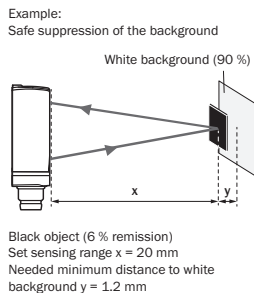
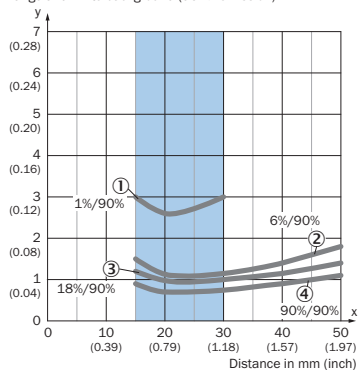

Recommended sensing range for the best performance

- ① Ultra-black object, 1% remission factor
- ② Black object, 6% remission factor
- ③ Gray object, 18% remission factor
- ④ White object, 90% remission factor

## Light spot size

### Vertical

Dimensions in mm (inch)

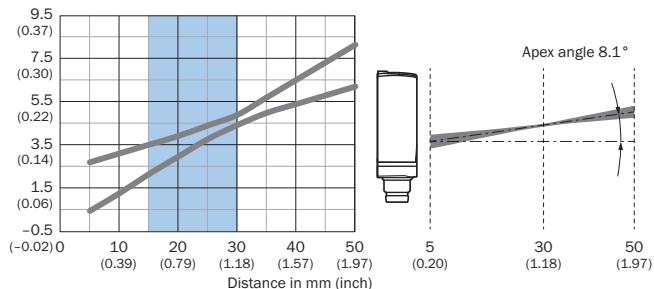

Recommended sensing range for the best performance

### Horizontal

Dimensions in mm (inch)

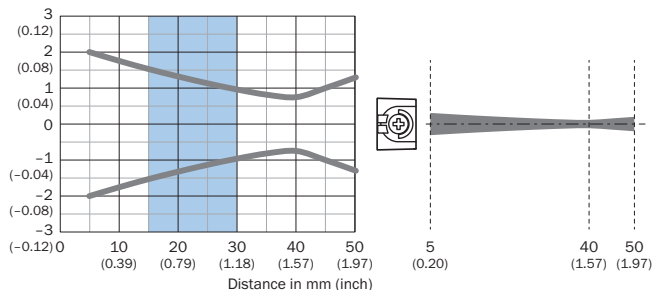

Recommended sensing range for the best performance

**Sensing range diagram**

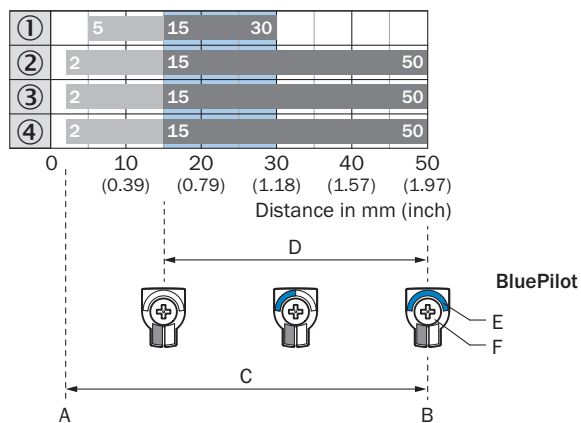

A = Sensing range min. in mm  
 B = Sensing range max. in mm  
 C = Viewing range  
 D = Adjustable switching threshold for background suppression  
 E = Sensing range indicator  
 F = Teach-Turn adjustment

Recommended sensing range for the best performance

- ① Ultra-black object, 1% remission factor
- ② Black object, 6% remission factor
- ③ Gray object, 18% remission factor
- ④ White object, 90% remission factor

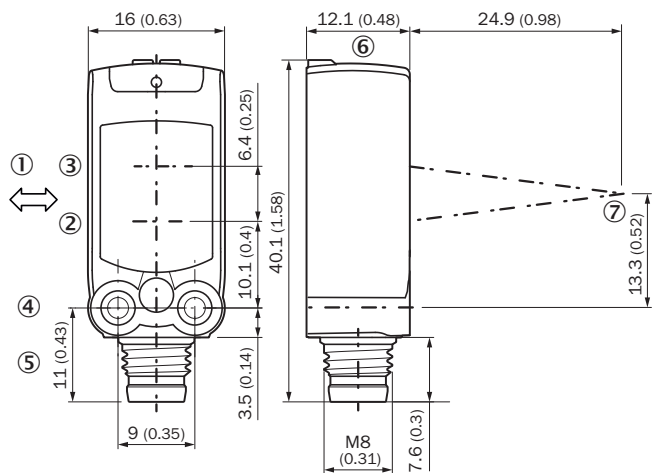

**Dimensional drawing** (Dimensions in mm (inch))



- ① Standard direction of the material being detected
- ② Center of optical axis, sender
- ③ Center of optical axis, receiver
- ④ M3 mounting hole
- ⑤ Connection
- ⑥ Display and adjustment elements
- ⑦ Focus

## Recommended accessories

Other models and accessories → [www.sick.com/W4](http://www.sick.com/W4)

	Brief description	Type	Part no.
Mounting brackets and plates			
	Mounting bracket for wall mounting, Stainless steel 1.4571, mounting hardware included	BEF-W4-A	2051628
Plug connectors and cables			
	<ul style="list-style-type: none"> <li>• <b>Connection type head A:</b> Female connector, M8, 4-pin, straight, A-coded</li> <li>• <b>Connection type head B:</b> Flying leads</li> <li>• <b>Signal type:</b> Sensor/actuator cable</li> <li>• <b>Cable:</b> 5 m, 4-wire, PVC</li> <li>• <b>Description:</b> Sensor/actuator cable, unshielded</li> <li>• <b>Application:</b> Zones with chemicals</li> </ul>	YF8U14-050VA3XLEAX	2095889
	<ul style="list-style-type: none"> <li>• <b>Connection type head A:</b> Male connector, M8, 4-pin, straight</li> <li>• <b>Description:</b> Unshielded</li> <li>• <b>Connection systems:</b> Screw-type terminals</li> <li>• <b>Permitted cross-section:</b> 0.14 mm<sup>2</sup> ... 0.5 mm<sup>2</sup></li> </ul>	STE-0804-G	6037323

## SICK AT A GLANCE

SICK is one of the leading manufacturers of intelligent sensors and sensor solutions for industrial applications. A unique range of products and services creates the perfect basis for controlling processes securely and efficiently, protecting individuals from accidents and preventing damage to the environment.

We have extensive experience in a wide range of industries and understand their processes and requirements. With intelligent sensors, we can deliver exactly what our customers need. In application centers in Europe, Asia and North America, system solutions are tested and optimized in accordance with customer specifications. All this makes us a reliable supplier and development partner.

Comprehensive services complete our offering: SICK LifeTime Services provide support throughout the machine life cycle and ensure safety and productivity.

For us, that is “Sensor Intelligence.”

## WORLDWIDE PRESENCE:

Contacts and other locations –[www.sick.com](http://www.sick.com)