

100526-3 ✓ ACTIVE

Z-PACK | Z-PACK 2mm HM

TE Internal #: 100526-3

Coding Key, Nut Brown, Z-PACK 2mm HM

[View on TE.com >](#)



Connectors > Connector Accessories > Connector Hardware



Hardware Accessory Function: **Coding & Keying**

Connector Hardware Accessory Type: **Coding Key**

Primary Product Color: **Nut Brown**

## Features

### Product Type Features

Hardware Accessory Function	Coding & Keying
Connector Hardware Accessory Type	Coding Key

### Body Features

Connector & Keying Code	4578
Primary Product Color	Nut Brown

### Usage Conditions

Compatible With Connector Style	Receptacle
---------------------------------	------------

### Packaging Features

Packaging Quantity	500
Packaging Method	Bag

## Product Compliance

[For compliance documentation, visit the product page on TE.com>](#)

EU RoHS Directive 2011/65/EU	Compliant
EU ELV Directive 2000/53/EC	Compliant
China RoHS 2 Directive MIIT Order No 32, 2016	No Restricted Materials Above Threshold

EU REACH Regulation (EC) No. 1907/2006

Current ECHA Candidate List: JUNE 2024 (241)

Candidate List Declared Against: JUNE 2024 (241)

Does not contain REACH SVHC

Halogen Content

Low Halogen - Br, Cl, F, I < 900 ppm per homogenous material. Also BFR/CFR/PVC Free

Solder Process Capability

Not applicable for solder process capability

Product Compliance Disclaimer

This information is provided based on reasonable inquiry of our suppliers and represents our current actual knowledge based on the information they provided. This information is subject to change. The part numbers that TE has identified as EU RoHS compliant have a maximum concentration of 0.1% by weight in homogenous materials for lead, hexavalent chromium, mercury, PBB, PBDE, DBP, BBP, DEHP, DIBP, and 0.01% for cadmium, or qualify for an exemption to these limits as defined in the Annexes of Directive 2011/65/EU (RoHS2). Finished electrical and electronic equipment products will be CE marked as required by Directive 2011/65/EU. Components may not be CE marked. Additionally, the part numbers that TE has identified as EU ELV compliant have a maximum concentration of 0.1% by weight in homogenous materials for lead, hexavalent chromium, and mercury, and 0.01% for cadmium, or qualify for an exemption to these limits as defined in the Annexes of Directive 2000/53/EC (ELV). Regarding the REACH Regulation, the information TE provides on SVHC in articles for this part number is based on the latest European Chemicals Agency (ECHA) 'Guidance on requirements for substances in articles' posted at this URL: <https://echa.europa.eu/guidance-documents/guidance-on-reach>

## Compatible Parts



## Also in the Series | Z-PACK 2mm HM

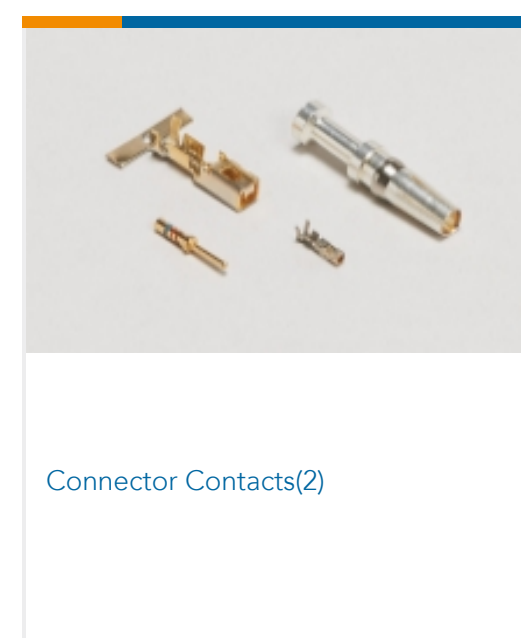
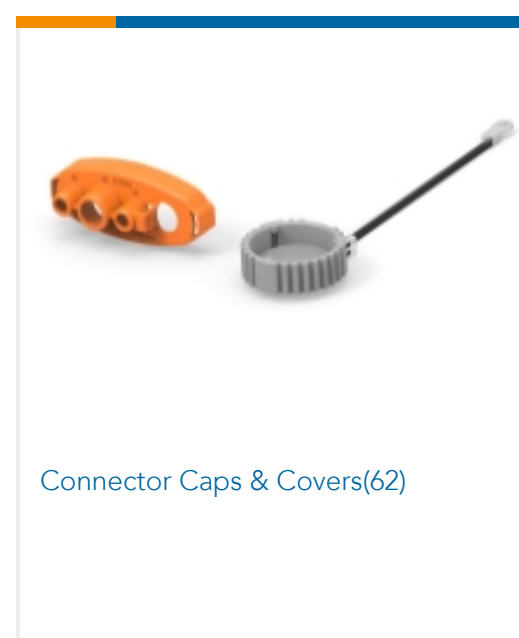
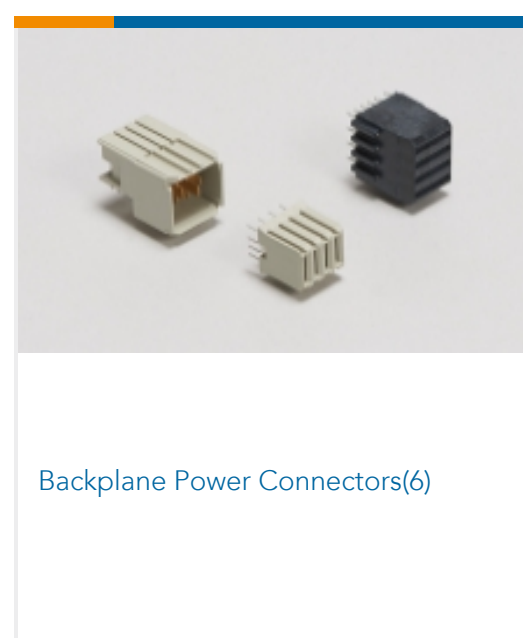
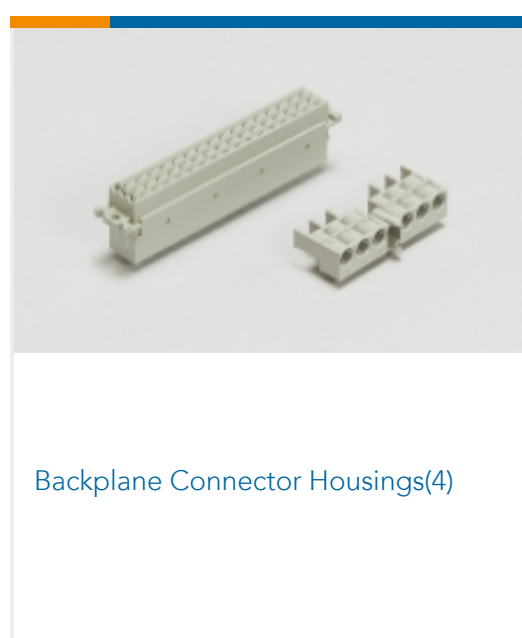



Connector Hardware(97)

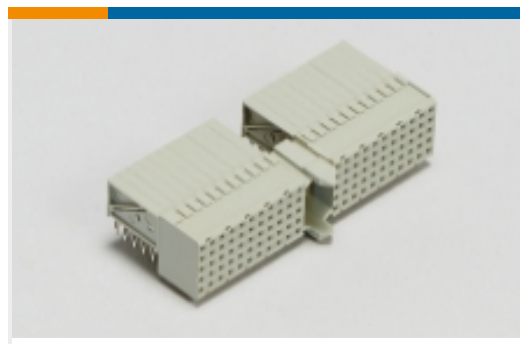

Hard Metric Backplane Connectors (267)

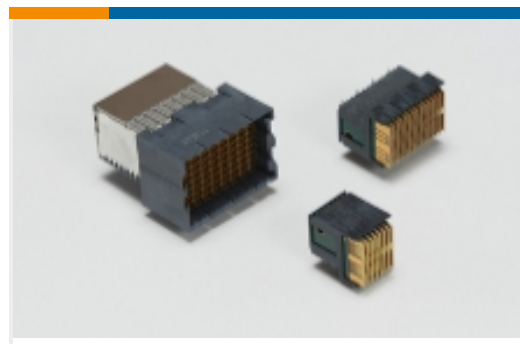

High Speed Backplane Connectors(1)

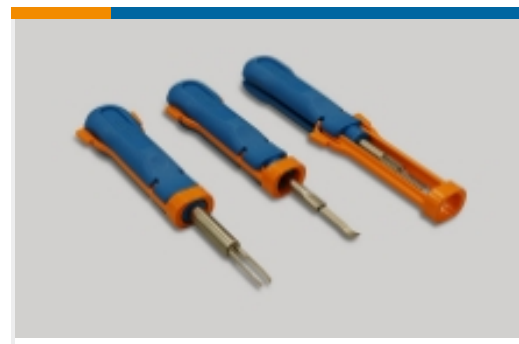

Insertion & Extraction Tools(2)



Rectangular Power Connectors(87)

### Customers Also Bought



TE Part #C71645-000  
RMW-10/3-1200/ADH-0

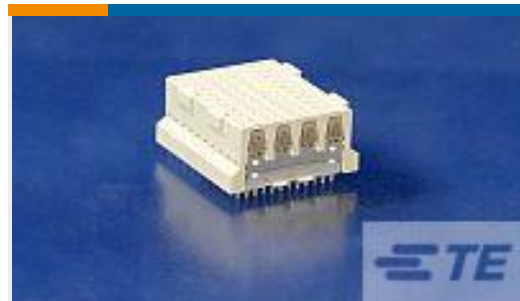

TE Part #1469362-1  
HM-ZD VERT RECPT ASSY 18MM

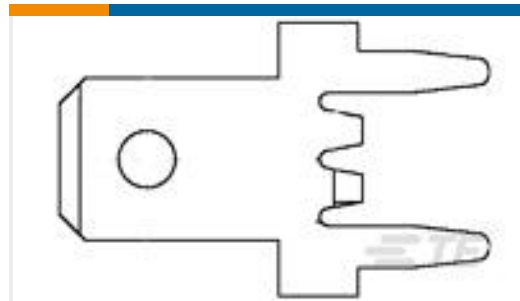

TE Part #63823-1  
187 FASTON TAB TPBR



TE Part #4-1614884-5  
CPF 0805 150R 0.1% 25PPM 1K RL

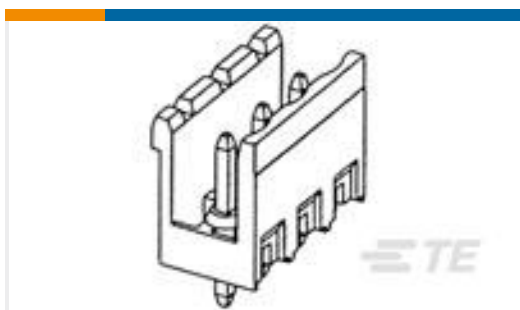

TE Part #1-282825-0  
TERMI-BLOK HEADER,ASSY90 10P.5



TE Part #9-1676123-9  
1/2W SM M/OX 5% 10K



TE Part #2309412-4  
DDR4 SODIMM 260P 8.0H RVS



TE Part #1SNA105052R2100  
MA2.5/5

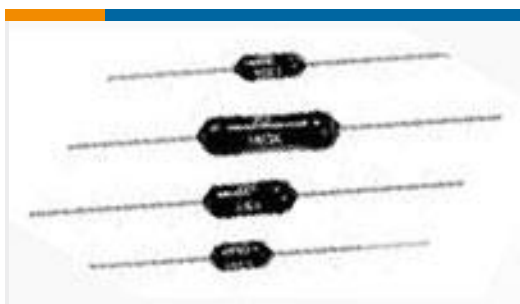

TE Part #6-1879621-8  
H4P 6K2 1% 50PPM

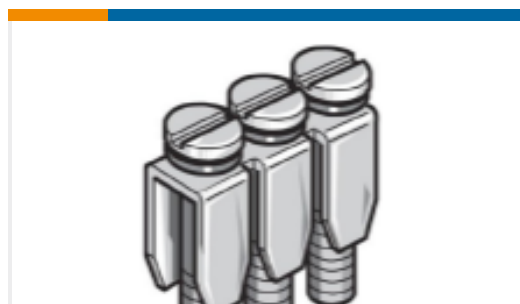

TE Part #1SNA176277R0500  
BJM5

### Documents



## Product Drawings

### Z-PACK F.CODING KEY

English

---

## CAD Files

### 3D PDF

3D

#### Customer View Model

[ENG\\_CVM\\_CVM\\_100526-3\\_E.2d\\_dxf.zip](#)

English

#### Customer View Model

[ENG\\_CVM\\_CVM\\_100526-3\\_E.3d\\_igs.zip](#)

English

#### Customer View Model

[ENG\\_CVM\\_CVM\\_100526-3\\_E.3d\\_stp.zip](#)

English

By downloading the CAD file I accept and agree to the [Terms and Conditions](#) of use.

---

## Product Specifications

### Application Specification

English