

标记 MARK	ECN编号/变更内容 ECN NO/DEFINITION	修改 REVISE	日期 DATE	核准 APPROVE

CKI	DIM A	DIM B	DIM C
2	2.00	6.0	3.0
3	4.00	8.0	3.0
4	6.00	10.00	3.0
5	8.00	12.00	5.0
6	10.00	14.00	7.0
7	12.00	16.00	9.0
8	14.00	18.00	11.0
9	16.00	20.00	13.0
10	18.00	22.00	15.0
11	20.00	24.00	17.0
12	22.00	26.00	19.0
13	24.00	28.00	21.0
14	26.00	30.00	23.0
15	28.00	32.00	25.0
16	30.00	34.00	27.0

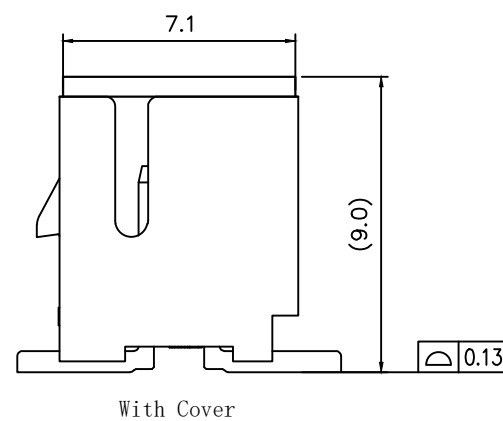
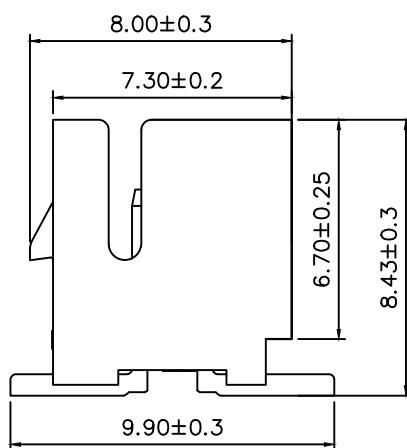
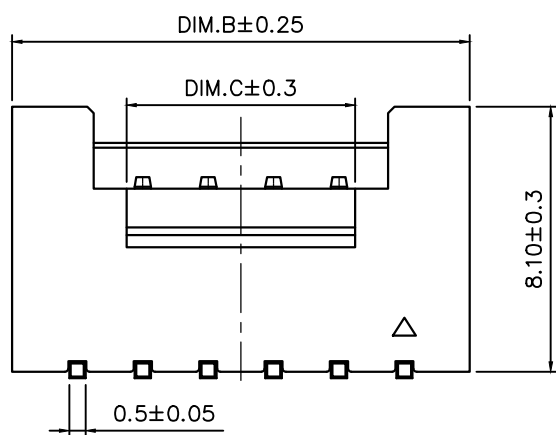
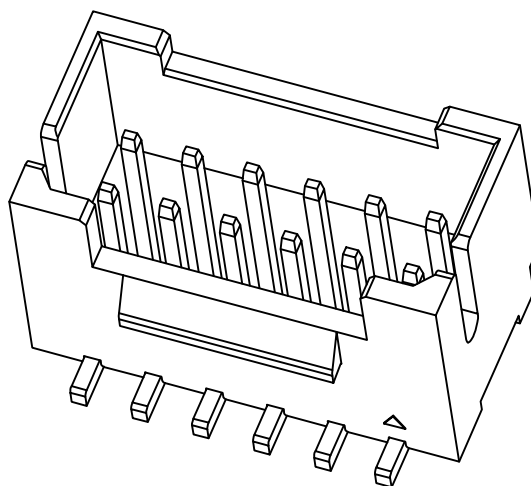
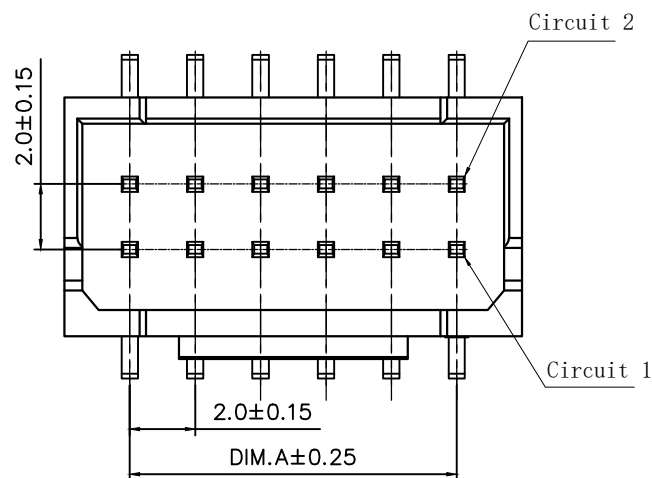

技术指标:

1. 工作温度: -25°C~85°C
2. 额定电压: 250V, DC/AC(rms)
3. 耐压值: 800V AC/minute
4. 接触电阻: ≤20mΩ
5. 绝缘电阻: ≥1000MΩ
6. 额定电流: 3.0A AC,DC
7. 适用线规: AWG#28~#22

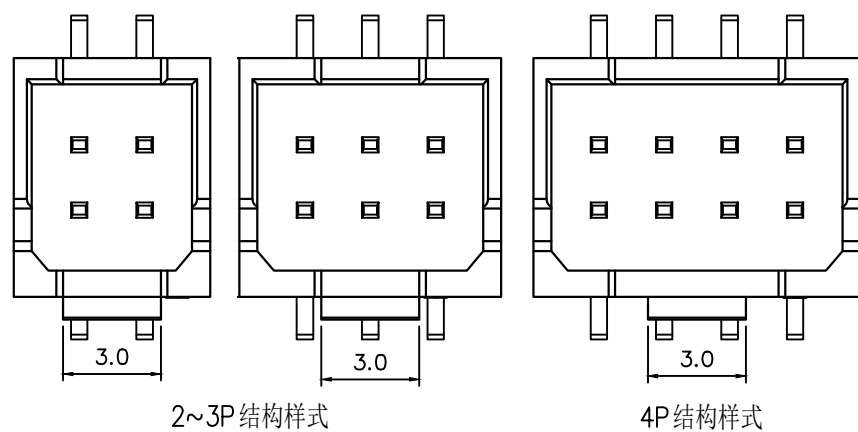

2~3P 结构样式

4P 结构样式

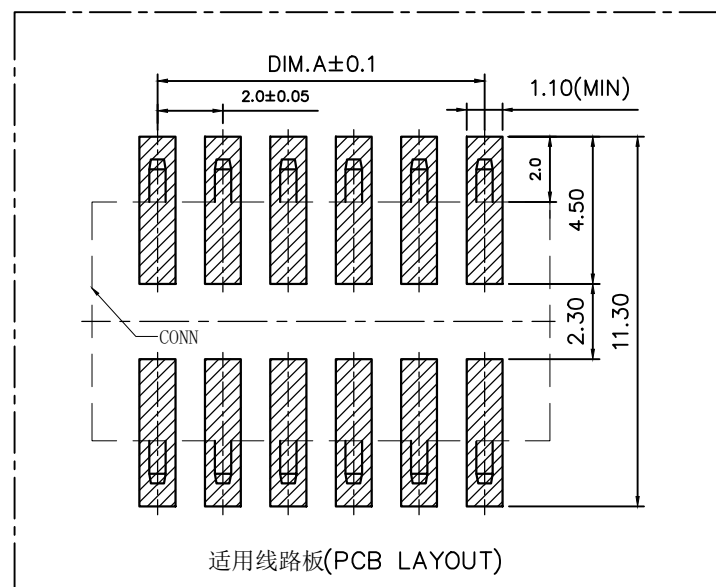

适用线路板(PCB LAYOUT)

序号	品名	材质	电镀/颜色	备注
2	插针	铜	镀锡	
1	基座	LCP	本色	

	深圳市虹成电子有限公司 品名 TITLE: 针座 料号 PART NO: HC-PHB2.0-2x2PLT		
	GENERAL TOLERANCES (UNLESS SPECIFIED) X. ±0.50 .XX ±0.10 .X ±0.20 .XXX ±0.05 ANGLES ±1°	比列 SCALE: 1:1 单位 UNIT: MM 张数 PART NO: 1 OF 1 版本 REV: A	

