

Features

- 13-A Output Current
- Single Device: 3.3V/5V Input
- 90% Efficiency (PT6715)
- On/Off Standby Function
- Differential Remote Sense
- Adjustable Output Voltage
- Short Circuit Protection
- 17-pin Space-Saving Package
- Solderable Copper Case

Description

The PT6715 series of power modules are a 13-A rated integrated switching regulator (ISR), housed in a 17-pin space saving solderable copper package. These modules will operate off either a 5V or 3.3V input power bus to provide a high-performance low-voltage power source for the industry's latest high-speed, DSPs, μ Ps, and bus drivers. This allows for the easy integration of these new low-voltage ICs into existing 3.3V or 5V systems without re-designing the central power supply. The series includes the standard output bus voltage options, ranging from 1.0V to 3.3V. Each output voltage has a limited adjust range.

Features include a Standby (On/Off) function, a differential output Remote Sense, and short circuit protection. The modules are available in both through-hole and surface mount configurations.

Ordering Information

- PT6715□ = 3.3 Volts
 PT6716□ = 2.5 Volts
 † PT6717□ = 1.8 Volts
 † PT6718□ = 1.5 Volts
 † PT6719□ = 1.2Volts
 † PT6714□ = 1.0Volts

† 3.3V Input Bus Capable

PT Series Suffix (PT1234 x)

Case/Pin Configuration	Order Suffix	Package Code *
Vertical	N	(EMD)
Horizontal	A	(EMA)
SMD	C	(EMC)

* Previously known as package styles 1340/50.
 (Reference the applicable package code drawing for the dimensions and PC board layout)

Pin-Out Information

Pin	Function
1	V_o Adjust
2	STBY*
3	Do Not Connect
4	V_{in}
5	V_{in}
6	V_{in}
7	Remote Sense Gnd
8	GND
9	GND
10	GND
11	GND
12	GND
13	V_{out}
14	V_{out}
15	V_{out}
16	V_{out}
17	Remote Sense V_{out}

* For further information, see application notes.

Standard Application

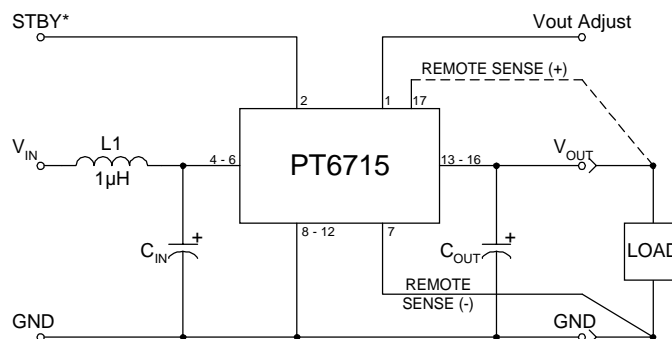

C_{in} = Required 1000 μ F electrolytic
 C_{out} = Required 330 μ F electrolytic
 L1 = Optional 1 μ H input choke

PT6715 Series

13-A 5V/3.3V-Input Adjustable Integrated Switching Regulator

Specifications (Unless otherwise stated, $T_a = 25^\circ\text{C}$, $V_{in} = 5\text{V}$, $C_{in} = 1,000\mu\text{F}$, $C_{out} = 330\mu\text{F}$, and $I_o = I_{o,max}$)

Characteristic	Symbol	Conditions	PT6715 Series			Units	
			Min	Typ	Max		
Output Current	I_o	$T_a = +60^\circ\text{C}$, 200LFM $T_a = +25^\circ\text{C}$, natural convection	0.1 ⁽¹⁾ 0.1 ⁽¹⁾	—	13 13	A	
Input Voltage Range	V_{in}	Over I_o Range	$V_o \geq 2.5\text{V}$ $V_o \leq 1.8\text{V}$	4.5 3.1	— —	5.5 5.5	VDC
Set Point Voltage Tolerance	V_o tol		—	± 1	± 1.5 ⁽²⁾	$\%V_o$	
Temperature Variation	Reg_{temp}	$-40^\circ \leq T_a \leq +85^\circ\text{C}$, $I_o = I_{o,min}$	—	± 0.5	—	$\%V_o$	
Line Regulation	Reg_{line}	Over V_{in} range	—	± 5	± 10	mV	
Load Regulation	Reg_{load}	Over I_o range	—	± 5	± 10	mV	
Total Output Voltage Variation	ΔV_o tot	Includes set-point, line, load, $-40^\circ \leq T_a \leq +85^\circ\text{C}$	—	± 2	± 3	$\%V_o$	
Efficiency	η	$I_o = 9\text{A}$	$V_o = 3.3\text{V}$ $V_o = 2.5\text{V}$ $V_o = 1.8\text{V}$ $V_o = 1.5\text{V}$ $V_o = 1.2\text{V}$ $V_o = 1.0\text{V}$	— — — — — —	91 88 85 83 78 75	— — — — — —	%
V_o Ripple (pk-pk)	V_r	20MHz bandwidth	—	35	—	mV_{pp}	
Transient Response	t_{tr}	5A/ μs load step, 50% to 100% $I_{o,max}$	—	50	—	μs	
	ΔV_{tr}	V_o over/undershoot	—	± 100	—	mV	
Over-Current Threshold	I_{TRIP}	Reset, followed by auto-recovery	—	20	32	A	
Switching Frequency	f_s	Over V_{in} and I_o range	300	350	400	kHz	
Remote On/Off (Pin 2)		Referenced to $-V_{in}$ (pin 8)					
Input High Voltage	V_{IH}		+2.0	—	Open ⁽³⁾	V	
Input Low Voltage	V_{IL}		-0.1	—	+0.4		
Input Low Current	I_{IL}		—	-0.5	—	mA	
Standby Input Current	$I_{in, standby}$	pins 2 & 8 connected	—	25	35	mA	
External Output Capacitance	C_{out}	See application schematic	330	—	15,000	μF	
External Input Capacitance	C_{in}	See application schematic	1,000	—	—	μF	
Operating Temperature Range	T_a	Over V_{in} range	-40 ⁽⁴⁾	—	+85 ⁽⁵⁾	$^\circ\text{C}$	
Storage Temperature	T_s	—	-40	—	+125	$^\circ\text{C}$	
Reliability	MTBF	Per Bellcore TR-332 50% stress, $T_a = 40^\circ\text{C}$, ground benign	5.4	—	—	10 ⁶ Hrs	
Mechanical Shock	—	Per Mil-Std-883D, method 2002.3, 1ms, half-sine, mounted to a fixture	—	500	—	G's	
Mechanical Vibration	—	Mil-Std-883D, Method 2007.2, 20-2000Hz, soldered in PCB	Suffix A	—	15 ⁽⁶⁾	—	G's
			Suffix C	—	20 ⁽⁶⁾	—	
Weight	—		—	23	—	grams	
Flammability	—	Materials meet UL 94V-0					

Notes: (1) The ISR will operate at no load with reduced specifications.

(2) If the remote sense feature is not being used, connect the Remote Sense Gnd (pin 7) to GND (pin 8) for optimum output voltage accuracy.

(3) The STBY* control (pin 2) has an internal pull-up and if it is left open circuit the module will operate when input power is applied. The open-circuit voltage is typically 12.6V, and maybe as high as 15V. Consult the related application note for other interface considerations.

(4) For operation below 0°C , C_{in} and C_{out} must have stable characteristics. Use either low ESR tantalum or Oscon® capacitors.

(5) See Safe Operating Area curves or contact the factory for the appropriate derating.

(6) The case pins on through-hole package types (suffixes N & A) must be soldered. For more information consult the applicable package outline drawing.

Input/Output Capacitors: The PT6715 series requires a 1,000 μF electrolytic (or tantalum) capacitor at the input and 330 μF at the output for proper operation in all applications. In addition, the input capacitance, C_{in} , must be rated for a minimum of 2Arms of ripple current. For transient or dynamic load applications additional capacitance may be necessary. For more information consult the related application note on capacitor recommendations.

Input Inductor: An input filter inductor is optional for most applications. The inductor must be sized to handle 10ADC with a typical value of 1 μH .

13-A 5V/3.3V-Input Adjustable Integrated Switching Regulator

Characteristic Data; $V_{in} = 5.0V$ (See Note A)

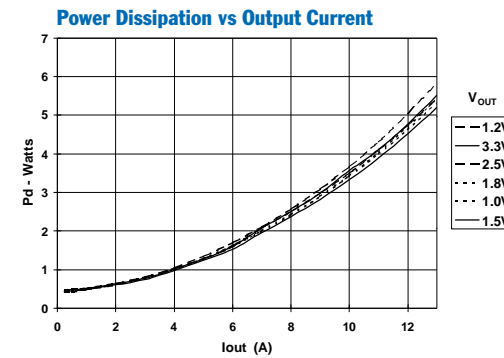
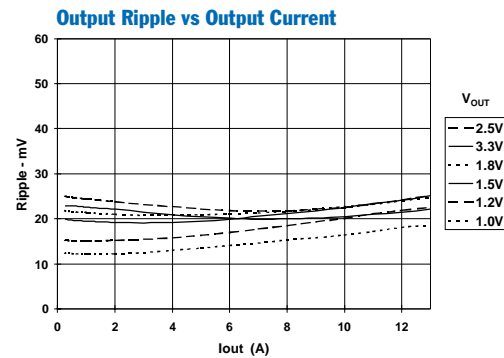
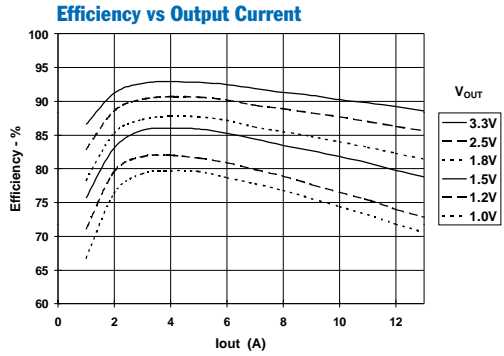

Safe Operating Area; $V_{in} = 5V$ (See Note B)

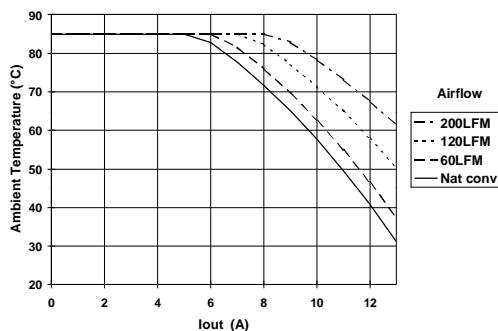

Characteristic Data; $V_{in} = 3.3V$ (See Note A)

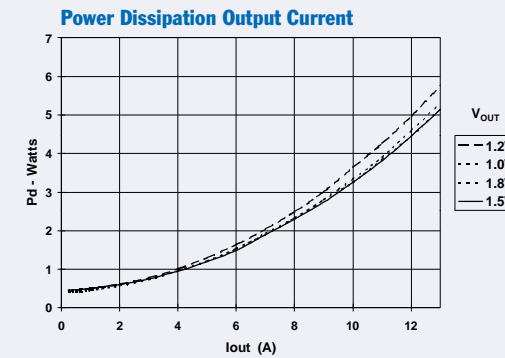
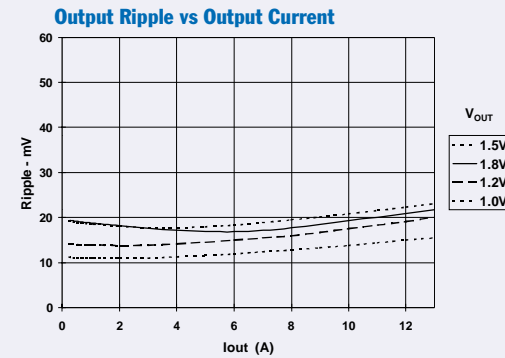
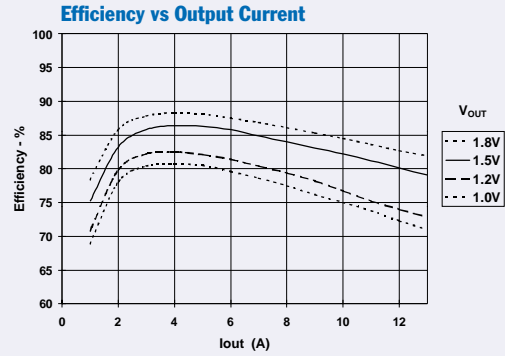

Safe Operating Area; $3.3V$ (See Note B)

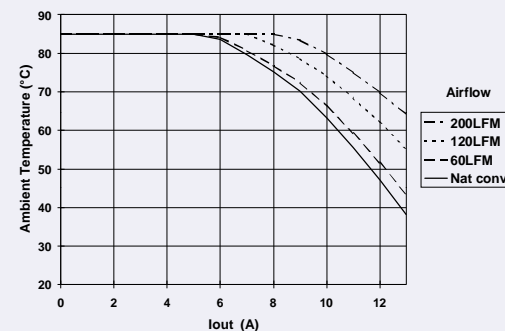

Note A: Characteristic data has been developed from actual products tested at 25°C. This data is considered typical data for the Converter.
 Note B: SOA curves represent the conditions at which internal components are at or below the manufacturer's maximum operating temperatures

Using the On/Off Standby Function on the PT6705/6715 Excalibur™ Series of ISRs

The PT6705 and PT6715 regulator series are non-programmable (preset voltage) versions of the PT6701, PT6702, and PT6703 products.

The PT6705/6715 series of products incorporate an on/off 'standby' function, which may be used to disable the regulator output. The standby function is provided by the *STBY** control, pin 2. If pin 2 is left open-circuit the regulator operates normally, and provides a regulated output when a valid supply voltage is applied to V_{in} (pins 4–6) with respect to GND (pins 8–12). If pin 2 is connected to ground, the regulator output is disabled and the input current drawn by the ISR typically drops to its idle value ¹. The standby control may also be used to hold-off the regulator output during the period that input power is applied.

Pin 2 is ideally controlled with an open-collector (or open-drain) discrete transistor (See Figure 1-1 ²). The open-circuit voltage will be approximately 12.0V. Table 1-1 gives the circuit parameters for this control input.

Table 1-1 Standby Control Requirements ^(3, 4)

Parameter	Min	Typ	Max
Enable (V_{IH})	—		Open Circuit
Disable (V_{IL})	-0.2V		0.4V
I_{stby} (pin 2 =ground)		-0.5mA	
V_{stby} (open circuit)		12.0V	15.0V

Notes:

- When the regulator output is disabled the current drawn from the $+V_{in}$ input source is typically reduced to 25mA for the PT671x series, and to less than 100µA for the PT670x series.
- Figure 1-1 is an application schematic for the PT670x models. This shows the requirement for an external +12V bias supply. The +12V bias is not required for the PT671x models. For more details, consult the applicable product data sheet.
- The standby control input requires no external pull-up resistor. The open-circuit voltage of the *STBY** pin is approximately 12.0V.
- The standby control input is Not compatible with TTL devices that incorporate a totem-pole output drive. Use only a true open-collector device, preferably a discrete bipolar transistor (or MOSFET). To ensure the regulator output is disabled, the control pin must be pulled to less than 0.4Vdc with a low-level 0.5mA sink to ground.
- After Q_1 in Figure 1-1 is turned off and before the output begins to rise, the regulator output will assert a low impedance to ground. If an external voltage is applied to the output it will sink current and possibly over-stress the part.

Figure 1-1

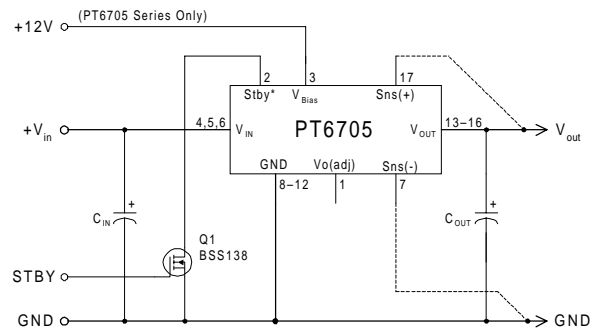

Turn-On Time: In the circuit of Figure 1-1, turning Q_1 on applies a low voltage to pin 2 and disables the regulator output. Correspondingly, turning Q_1 off removes the low-voltage signal and enables the output ⁵. Once enabled, the output will typically experience a 10–15ms delay followed by a predictable ramp-up of voltage. The regulator provides a fully regulated output within 40ms. The waveforms of Figure 1-2 show the rise of both the output voltage and input current for a PT6706 (2.5V). The turn off of Q_1 corresponds to the rise of V_{stby} . The waveform was measured with a 5-Vdc input voltage and an 8-ADC load.

Figure 1-2

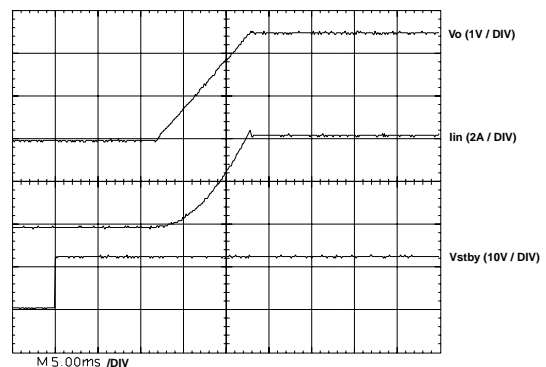

Adjusting the Output Voltage of the PT6705 and PT6715 Excalibur™ Series of Regulators

Both the PT6705 and PT6715 series ISRs are non-programmable versions of the PT6700 Excalibur™ family of converters. The output voltage of these regulators have a fixed output voltage, which may be adjusted higher or lower than the factory pre-set voltage using a single external resistor. Table 2-1 gives the adjustment range for each model in the series as V_a (min) and V_a (max).

Adjust Up: An increase in the output voltage is obtained by adding a resistor R_2 , between pin 1 (V_o Adjust) and pin 7 (Remote Sense GND).

Adjust Down: Add a resistor (R_1), between pin 1 (V_o Adjust) and pin 17 (Remote Sense V_{out}).

Refer to Figure 2-1 and Table 2-2 for both the placement and value of the required resistor, either (R_1) or R_2 as appropriate.

Notes:

1. Use only a single 1% resistor in either the (R_1) or R_2 location. Place the resistor as close to the regulator as possible.
2. Never connect capacitors from V_o Adjust to either GND, V_{out} , or the Remote Sense pins. Adding capacitance to the V_o Adjust pin will affect the stability of the ISR.
3. If the Remote Sense feature is not being used, pin 7 must be connected to pin 8 for optimum output voltage accuracy. Correspondingly the resistors (R_1) and R_2 may be then be connected from V_o Adjust to either V_{out} or GND respectively.

4. The PT6705 series requires a 12V external bias voltage in order to operate (see data sheet). An external bias voltage is not required for the PT6715 series.
5. Adjusting the output voltage of the PT6705 and PT6715 (3.3V output) higher than the factory pre-set voltage may require an increase in the minimum input voltage. These two models must comply with the following requirements for $V_{in(min)}$.

PT6705:

$$V_{in(min)} = (V_a + 1)V$$

PT6715:

$$V_{in(min)} = (V_a + 1)V \text{ or } 4.5V, \text{ whichever is greater.}$$

The values of (R_1) [adjust down], and R_2 [adjust up], can also be calculated using the following formulas.

$$(R_1) = \frac{R_o (V_a - V_r)}{V_o - V_a} - R_s \quad k\Omega$$

$$R_2 = \frac{R_o \cdot V_r}{V_a - V_o} - R_s \quad k\Omega$$

Where: V_o = Original output voltage
 V_a = Adjusted output voltage
 V_r = Reference voltage (Table 2-1)
 R_o = Resistance constant (Table 2-1)
 R_s = Internal series resistance (Table 2-1)

Figure 2-1

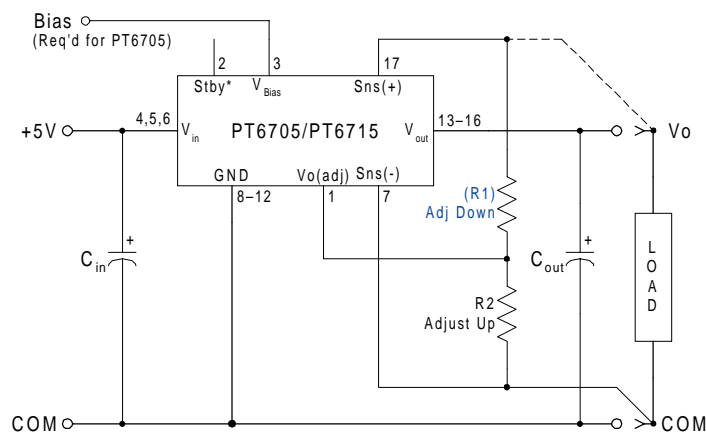

PT6705/PT6715 Series

Table 2-1

ADJUSTMENT RANGE AND FORMULA PARAMETERS

Series Pt #						
12V Bias (4)	—	—	PT6708	PT6707	PT6706	PT6705
No Bias	PT6714	PT6719	PT6718	PT6717	PT6716	PT6715
V _o (nom)	1.0	1.2	1.5	1.8	2.5	3.3
V _a (min)	0.94	1.09	1.47	1.75	2.25	2.75
V _a (max)	1.32	1.52	1.73	2.0	2.85	3.75
V _r (V)	0.8	0.8	1.27	1.27	1.27	1.27
R _o (kΩ)	10.0	10.0	10.2	10.0	10.0	10.0
R _e (kΩ)	24.9	24.9	49.9	49.9	33.2	24.9

Table 2-2

ADJUSTMENT RESISTOR VALUES

Series Pt #					Series Pt #		
12V Bias (4)	—	—	PT6708	PT6707	12V Bias (4)	PT6706	PT6705
No Bias	PT6714	PT6719	PT6718	PT6717	No Bias	PT6716	PT6715
V _o (nom)	1.0V	1.2V	1.5V	1.8V	V _o (nom)	2.5V	3.3V
V _a (req'd)					V _a (req'd)		
0.950	(5.1)kΩ				2.25	(6.0)kΩ	
0.975	(45.1)kΩ				2.3	(18.3)kΩ	
1.000					2.35	(38.8)kΩ	
1.025	295.0kΩ				2.4	(79.8)kΩ	
1.050	135.0kΩ				2.45	(203.0)kΩ	
1.075	81.8kΩ				2.5		
1.100	55.1kΩ	(5.1)kΩ			2.55	221.0kΩ	
1.125	39.1kΩ	(18.4)kΩ			2.6	93.8kΩ	
1.150	28.4kΩ	(45.1)kΩ			2.65	51.5kΩ	
1.175	20.8kΩ	(125.0)kΩ			2.7	30.3kΩ	
1.200	15.1kΩ				2.75	17.6kΩ	
1.225	10.7kΩ	295.0kΩ			2.8	9.1kΩ	
1.250	7.1kΩ	135.0kΩ			2.85	3.1kΩ	
1.275	4.2kΩ	81.8kΩ			2.75		(2.0)kΩ
1.300	1.8kΩ	55.1kΩ			2.80		(5.7)kΩ
1.325		39.1kΩ			2.85		(10.2)kΩ
1.350		28.4kΩ			2.90		(15.9)kΩ
1.375		20.8kΩ			2.95		(23.1)kΩ
1.400		15.1kΩ			3.00		(32.8)kΩ
1.425		10.7kΩ			3.05		(46.3)kΩ
1.450		7.1kΩ			3.10		(66.6)kΩ
1.475		4.2kΩ	(32.1)kΩ		3.15		(100.0)kΩ
1.50		1.8kΩ			3.20		(168.0)kΩ
1.55			204.0kΩ		3.25		(371.0)kΩ
1.60			77.1kΩ		3.30		
1.65			34.8kΩ		3.35		229.0kΩ
1.70			13.6kΩ		3.40		102.0kΩ
1.75				(46.1)kΩ	3.45		59.8kΩ
1.80					3.50	(Note 5)	38.6kΩ
1.85				204.0kΩ	3.55		25.9kΩ
1.90				77.1kΩ	3.60		17.4kΩ
1.95				34.8kΩ	3.65		11.4kΩ
2.00				13.6kΩ	3.70		6.9kΩ
					3.75		3.3kΩ

R₁ = (Blue) R₂ = Black

Capacitor Recommendations for the Non-Isolated 13-A Excalibur™ Series of Regulators

Input Capacitors

The recommended input capacitor(s) is determined by the 2 ampere (rms) minimum ripple current rating and 1,000µF minimum capacitance. Ripple current and $\leq 100\text{m}\Omega$ ESR (Equivalent Series Resistance) values are the major considerations, along with temperature, when selecting the proper capacitor. Tantalum capacitors have a recommended minimum voltage rating of $2\times$ the input voltage; 10V for +5V operation.

Output Capacitors

The minimum required output capacitance is 330µF with a maximum ESR $\leq 100\text{m}\Omega$. Failure to observe this requirement may lead to regulator instability or oscillation. Electrolytic capacitors have poor ripple performance at frequencies greater than 400kHz, but excellent low frequency transient response. Above the ripple frequency ceramic decoupling capacitors are necessary to improve the transient response and reduce any high frequency noise components apparent during higher current excursions. Preferred low ESR type capacitor part numbers are identified in Table 3-1 below.

Tantalum Characteristics

Tantalum capacitors with a minimum 10V rating are recommended for the input bus, but only the AVX TPS, Sprague 594/595, or Kemet T495/T510 series. These types are recommended over many others due to their higher surge current, power dissipation and ripple current capability. As a caution, the TAJ series by AVX is not recommended. This series exhibits considerably higher ESR, reduced power dissipation and lower ripple current capability. The TAJ Series is also less reliable compared to the TPS series when determining power dissipation capability. Tantalum capacitors are highly recommended in applications where ambient temperatures fall below 0°C.

Capacitor Table

Table 3-1 identifies the characteristics of capacitors from a number of vendors with acceptable ESR and ripple current (rms) ratings. The suggested minimum quantities per regulator for both the input and output buses are identified.

This is not an extensive capacitor list. Capacitors from other vendors are available with comparable specifications. Those listed are for guidance. The RMS ripple current rating and ESR (Equivalent Series Resistance at 100kHz) are the critical parameters to insure both optimum regulator performance and long capacitor life.

Table 3-1 Capacitors Characteristic Data

Capacitor Vendor Series	Capacitor Characteristics					Quantity		Vendor Number
	Working Voltage	Value(µF)	(ESR) Equivalent Series Resistance	85°C Maximum Ripple Current(Irms)	Physical Size(mm)	Input Bus	Output Bus	
Panasonic FC/FK (Surface Mount)	25V	1000	0.038Ω	2000mA	18×16.5	1	1	EEVFC1E102N EEVFK1V331P
	35V	330	0.080Ω	850mA	10×10.2	1	1	
FC (Radial)	25V	330	0.090Ω	755mA	10×12.5	1	1	EEUFC1E331 EEUFC1E122S
	25V	1200	0.038Ω	2000mA	18×15			
United Chemi-Con LXV (Radial)	25V	330	0.084Ω	825mA	10×16	1	1	LXV25VB331M10X16LL LXV35VB122M16X25LL LXV16VB272M16X25LL
	35V	1200	0.028Ω	2070mA	16×25			
	16V	2700	0.028Ω	2070mA	16×25			
FX (Surface Mount)	10V	680	0.015Ω+2 =0.007Ω	>7000mA	10×10.5	2	1	10FX680M (Os-con)
Nichicon PL Series	25V	330	0.095Ω	750mA	10×15	1	1	UPL1E331MPH6 UPL1E222MHH6
	25V	2200	0.028Ω	2050mA	18×20			
	PM Series	25V	330	0.095Ω	750mA			
Os-con: SS SVP (Surface Mount)	10V	330	0.025Ω+3 =0.008Ω	>7000mA	10×10.5	3	1	10SS330M 10SVP330
	10V	330	0.025Ω+3 =0.008Ω	>7000mA	10.3×11	3	1	
AVX Tanatalum TPS Series (Surface Mount)	10V	330	0.100Ω+3 =0.034Ω	>3500mA	7.0 L ×5.97 W ×3.45 H	3	1	TPSV337M010R0100 TPSV337M010R0060
	10V	330	0.060Ω+3 =0.020Ω	>3500mA		3	1	
Vishay/Sprague Tantalum 595D/594D Series (Surface Mount)	10V	330	0.045Ω+3 =0.015Ω	>4600mA	7.2 L ×6.0 W ×3.5 H	3	1	594D337X0010R2T
	10V	680	0.090Ω+4 =0.023Ω	>2500mA		2	1	595D687X0010R2T
Kemet Tantalum T510/T495 Series (Surface Mount)	10V	330	0.035Ω+3 =0.012Ω	>5000mA	7.3 L ×4.3 W ×4.0 H	3	1	T510X337M010AS
	10V	220	0.070Ω+5 =0.035Ω	>3000mA		5	2	T495X227M010AS
Sanyo Poscap TPB (surface Mount)	10V	220	0.040Ω+5 =0.008Ω	>3000mA	7.2 L ×4.3 W ×3.1 H	5	2	10TPB220M

PACKAGING INFORMATION

Orderable Device	Status ⁽¹⁾	Package Type	Package Drawing	Pins	Package Qty	Eco Plan ⁽²⁾	Lead/ Ball Finish	MSL Peak Temp ⁽³⁾	Samples (Requires Login)
PT6715A	NRND	SIP MODULE	EMA	17	10	TBD	Call TI	Level-1-215C-UNLIM	
PT6715C	NRND	SIP MODULE	EMC	17	10	TBD	Call TI	Level-3-215C-168HRS	
PT6715N	NRND	SIP MODULE	EMD	17	10	TBD	Call TI	Level-1-215C-UNLIM	
PT6717A	NRND	SIP MODULE	EMA	17	10	TBD	Call TI	Level-1-215C-UNLIM	
PT6718A	NRND	SIP MODULE	EMA	17	10	TBD	Call TI	Level-1-215C-UNLIM	
PT6718C	NRND	SIP MODULE	EMC	17	10	TBD	Call TI	Level-3-215C-168HRS	
PT6719C	OBSOLETE	SIP MODULE	EMC	17		TBD	Call TI	Call TI	

⁽¹⁾ The marketing status values are defined as follows:

ACTIVE: Product device recommended for new designs.

LIFEBUY: TI has announced that the device will be discontinued, and a lifetime-buy period is in effect.

NRND: Not recommended for new designs. Device is in production to support existing customers, but TI does not recommend using this part in a new design.

PREVIEW: Device has been announced but is not in production. Samples may or may not be available.

OBSOLETE: TI has discontinued the production of the device.

⁽²⁾ Eco Plan - The planned eco-friendly classification: Pb-Free (RoHS), Pb-Free (RoHS Exempt), or Green (RoHS & no Sb/Br) - please check <http://www.ti.com/productcontent> for the latest availability information and additional product content details.

TBD: The Pb-Free/Green conversion plan has not been defined.

Pb-Free (RoHS): TI's terms "Lead-Free" or "Pb-Free" mean semiconductor products that are compatible with the current RoHS requirements for all 6 substances, including the requirement that lead not exceed 0.1% by weight in homogeneous materials. Where designed to be soldered at high temperatures, TI Pb-Free products are suitable for use in specified lead-free processes.

Pb-Free (RoHS Exempt): This component has a RoHS exemption for either 1) lead-based flip-chip solder bumps used between the die and package, or 2) lead-based die adhesive used between the die and leadframe. The component is otherwise considered Pb-Free (RoHS compatible) as defined above.

Green (RoHS & no Sb/Br): TI defines "Green" to mean Pb-Free (RoHS compatible), and free of Bromine (Br) and Antimony (Sb) based flame retardants (Br or Sb do not exceed 0.1% by weight in homogeneous material)

⁽³⁾ MSL, Peak Temp. -- The Moisture Sensitivity Level rating according to the JEDEC industry standard classifications, and peak solder temperature.

Important Information and Disclaimer: The information provided on this page represents TI's knowledge and belief as of the date that it is provided. TI bases its knowledge and belief on information provided by third parties, and makes no representation or warranty as to the accuracy of such information. Efforts are underway to better integrate information from third parties. TI has taken and continues to take reasonable steps to provide representative and accurate information but may not have conducted destructive testing or chemical analysis on incoming materials and chemicals. TI and TI suppliers consider certain information to be proprietary, and thus CAS numbers and other limited information may not be available for release.

In no event shall TI's liability arising out of such information exceed the total purchase price of the TI part(s) at issue in this document sold by TI to Customer on an annual basis.

IMPORTANT NOTICE

Texas Instruments Incorporated and its subsidiaries (TI) reserve the right to make corrections, modifications, enhancements, improvements, and other changes to its products and services at any time and to discontinue any product or service without notice. Customers should obtain the latest relevant information before placing orders and should verify that such information is current and complete. All products are sold subject to TI's terms and conditions of sale supplied at the time of order acknowledgment.

TI warrants performance of its hardware products to the specifications applicable at the time of sale in accordance with TI's standard warranty. Testing and other quality control techniques are used to the extent TI deems necessary to support this warranty. Except where mandated by government requirements, testing of all parameters of each product is not necessarily performed.

TI assumes no liability for applications assistance or customer product design. Customers are responsible for their products and applications using TI components. To minimize the risks associated with customer products and applications, customers should provide adequate design and operating safeguards.

TI does not warrant or represent that any license, either express or implied, is granted under any TI patent right, copyright, mask work right, or other TI intellectual property right relating to any combination, machine, or process in which TI products or services are used. Information published by TI regarding third-party products or services does not constitute a license from TI to use such products or services or a warranty or endorsement thereof. Use of such information may require a license from a third party under the patents or other intellectual property of the third party, or a license from TI under the patents or other intellectual property of TI.

Reproduction of TI information in TI data books or data sheets is permissible only if reproduction is without alteration and is accompanied by all associated warranties, conditions, limitations, and notices. Reproduction of this information with alteration is an unfair and deceptive business practice. TI is not responsible or liable for such altered documentation. Information of third parties may be subject to additional restrictions.

Resale of TI products or services with statements different from or beyond the parameters stated by TI for that product or service voids all express and any implied warranties for the associated TI product or service and is an unfair and deceptive business practice. TI is not responsible or liable for any such statements.

TI products are not authorized for use in safety-critical applications (such as life support) where a failure of the TI product would reasonably be expected to cause severe personal injury or death, unless officers of the parties have executed an agreement specifically governing such use. Buyers represent that they have all necessary expertise in the safety and regulatory ramifications of their applications, and acknowledge and agree that they are solely responsible for all legal, regulatory and safety-related requirements concerning their products and any use of TI products in such safety-critical applications, notwithstanding any applications-related information or support that may be provided by TI. Further, Buyers must fully indemnify TI and its representatives against any damages arising out of the use of TI products in such safety-critical applications.

TI products are neither designed nor intended for use in military/aerospace applications or environments unless the TI products are specifically designated by TI as military-grade or "enhanced plastic." Only products designated by TI as military-grade meet military specifications. Buyers acknowledge and agree that any such use of TI products which TI has not designated as military-grade is solely at the Buyer's risk, and that they are solely responsible for compliance with all legal and regulatory requirements in connection with such use.

TI products are neither designed nor intended for use in automotive applications or environments unless the specific TI products are designated by TI as compliant with ISO/TS 16949 requirements. Buyers acknowledge and agree that, if they use any non-designated products in automotive applications, TI will not be responsible for any failure to meet such requirements.

Following are URLs where you can obtain information on other Texas Instruments products and application solutions:

Products

Audio	www.ti.com/audio
Amplifiers	amplifier.ti.com
Data Converters	dataconverter.ti.com
DLP® Products	www.dlp.com
DSP	dsp.ti.com
Clocks and Timers	www.ti.com/clocks
Interface	interface.ti.com
Logic	logic.ti.com
Power Mgmt	power.ti.com
Microcontrollers	microcontroller.ti.com
RFID	www.ti-rfid.com
RF/IF and ZigBee® Solutions	www.ti.com/lprf

Applications

Communications and Telecom	www.ti.com/communications
Computers and Peripherals	www.ti.com/computers
Consumer Electronics	www.ti.com/consumer-apps
Energy and Lighting	www.ti.com/energy
Industrial	www.ti.com/industrial
Medical	www.ti.com/medical
Security	www.ti.com/security
Space, Avionics and Defense	www.ti.com/space-avionics-defense
Transportation and Automotive	www.ti.com/automotive
Video and Imaging	www.ti.com/video
Wireless	www.ti.com/wireless-apps

TI E2E Community Home Page

e2e.ti.com

Mailing Address: Texas Instruments, Post Office Box 655303, Dallas, Texas 75265
Copyright © 2011, Texas Instruments Incorporated