

DO NOT SCALE FROM THIS PRINT

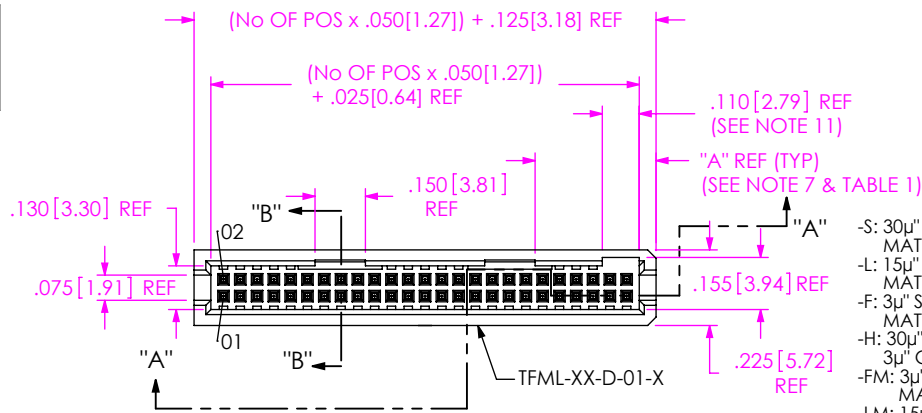

FIG 1
-01: THROUGH HOLE

No OF POSITIONS
-05,-07,-10 THRU -50
(PER ROW)

LEAD STYLE
-01: THROUGH HOLE
(SEE FIG 1)
-02: SURFACE MOUNT
(SEE FIG 3, SHT 2)

PLATING SPECIFICATION
-S: 30µ" SELECTIVE GOLD IN CONTACT AREA, MATTE TIN ON TAIL
-L: 15µ" SELECTIVE GOLD IN CONTACT AREA, MATTE TIN ON TAIL
-F: 3µ" SELECTIVE GOLD IN CONTACT AREA, MATTE TIN ON TAIL
-H: 30µ" GOLD IN CONTACT AREA, 3µ" GOLD ON TAIL
-FM: 3µ" SELECTIVE GOLD IN CONTACT AREA, MATTE TIN ON TAIL
-LM: 15µ" SELECTIVE GOLD IN CONTACT AREA, MATTE TIN ON TAIL
-SM: 30µ" SELECTIVE GOLD IN CONTACT AREA, MATTE TIN ON TAIL
-STL: 30µ" SELECTIVE GOLD IN CONTACT AREA, TIN/LEAD (90/10+/-5%) TAIL

OPTION
-A: ALIGNMENT PIN (USE TFML-XX-D-01-A) (SEE FIG 7, SHT 3)
-LC: LOCKING CLIP (USE LC-05-TM) SEE NOTE 12 (SEE FIG 9, SHT 3, N/A ON -RA OPTION)
-P: PICK & PLACE PAD (USE PPP-72 FOR -05 & -07. USE PPP-04 FOR -10 THRU -50) (AVAIL IN ALL POSITIONS, N/A ON -RA OPTION, SEE FIG 5, SHT 2)
-RA: RIGHT ANGLE (LEAD STYLE -01 ONLY) (SEE FIG 4, SHT 2)
-TR: TAPE & REEL (SEE FIG 2) (N/A ON -01 LEAD STYLE) (SEE NOTE 13)
-SA: STAKED ALIGNMENT PIN (USE SM-A5) (SEE FIG 8, SHT 3)
-K: POLYIMIDE FILM (USE K-DOT-.217-.313-.005) (SEE FIG 6, SHT 2) (N/A ON -RA)
-SN: SOLDER NAIL (USE TFML-XX-D-01-SN & WT-27-01-T) (SEE FIG 10, SHEET 4) (AVAILABLE ON -02 LEAD STYLE ONLY)
-SN2: SOLDER NAIL FOR .093 BOARD (USE TFML-XX-D-01-SN & WT-27-02-T) (SEE FIG 10, SHEET 4) (AVAILABLE ON -02 LEAD STYLE ONLY) (NOT AVAILABLE WITH -A, -LC, -RA, -SA)
-FR: FULL REEL QTY. TAPE & REEL (N/A ON -01 LEAD STYLE) (SEE NOTE 14)

ROW SPECIFICATION
-D: DOUBLE ROW

NOTES:

1. Ⓢ REPRESENTS A CRITICAL DIMENSION.
2. COPLANARITY: POSITIONS -05 THRU -26: .004[0.10] POSITIONS -27 THRU -50: .006[0.15]
3. MANUFACTURING IN-PROCESS DIMENSION DESIGNED TO ACHIEVE FINISHED ASSEMBLY. Ⓢ
4. MINIMUM PUSHOUT FORCE: 12 OZ. Ⓢ
5. MAXIMUM ALLOWABLE BOW: .004 INCH/INCH [0.10 MM/MM] AFTER ASSEMBLY.
6. MEASURED FROM BEND.
7. POSITIONS -05 AND -07 WILL ONLY HAVE ONE CLIP AT DIMENSION SHOWN; POSITIONS -10 THROUGH -24 WILL HAVE ONLY ONE CLIP AT DIMENSION SHOWN; POSITIONS -25 THROUGH -34 WILL HAVE TWO CLIPS AT DIMENSION SHOWN; POSITIONS -35 THROUGH -50 WILL HAVE THREE CLIPS: TWO AT DIMENSION SHOWN & ONE CENTERED ON INSULATOR.
8. NOTE DELETED.
9. .003[0.08] MAXIMUM TERMINAL BURR
10. .005[0.13] MAXIMUM HEIGHT VARIATION BETWEEN ANY TWO PINS.
11. DIMENSION IS NOT APPLICABLE FOR -05 AND -07 POSITION.
12. DUE TO THE HIGH AMOUNT OF INSERTION FORCE NEEDED, THE -LC OPTION IS NOT COMPATIBLE WITH AUTO PLACEMENT. SAMTEC RECOMMENDS MANUAL PLACEMENT FOR ALL ASSEMBLIES WITH THE -LC OPTION.
13. -TR OPTION ORDERS INVOLVING PARTIAL REEL QUANTITIES MAY BE PACKAGED ACCORDING TO THE SAMTEC PACKAGING EFFICIENCY STANDARDS (SPES) FOUND ON WWW.SAMTEC.COM
14. -FR OPTIONS WILL BE SHIPPED AT THE MAX QUANTITY PER REEL, BASED ON OPTIONS SELECTED.

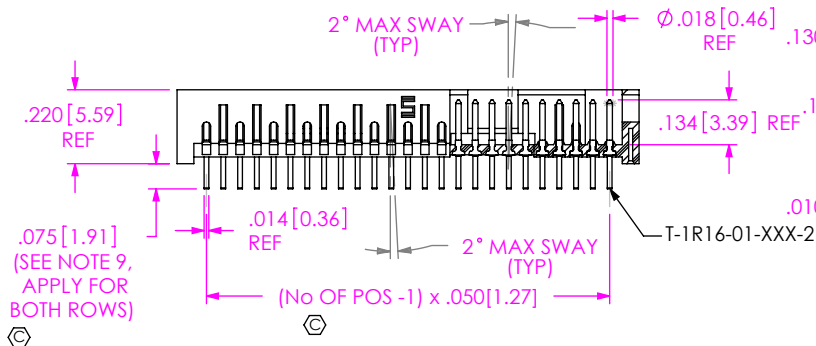

SECTION "A"-"A"

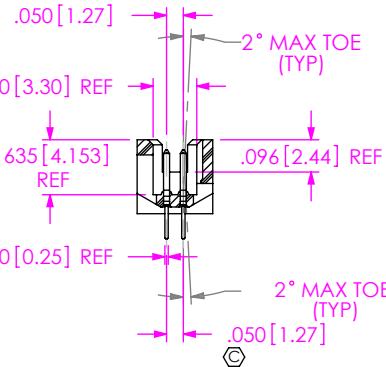

SECTION "B"-"B"

NO OF POS.	"A"
EVEN	.310
ODD (EXCL. -05,-07 POS)	.360
-05,-07	.113

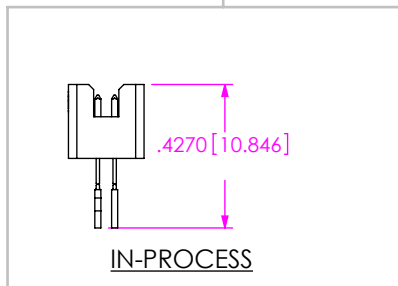
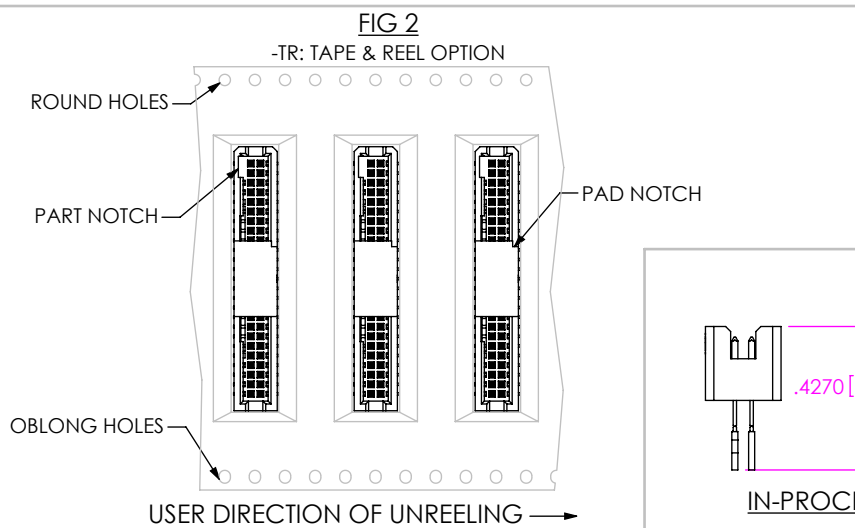

UNLESS OTHERWISE SPECIFIED, DIMENSIONS ARE IN INCHES.
TOLERANCES ARE:
DECIMALS ANGLES
.XX: ±.01 2°
.XXX: ±.005
.XXXX: ±.0020

PROPRIETARY NOTE
THIS DOCUMENT CONTAINS CONFIDENTIAL AND PROPRIETARY INFORMATION AND ALL DESIGN, MANUFACTURING, REPRODUCTION, USE, PATENT RIGHTS AND SALES RIGHTS ARE EXPRESSLY RESERVED BY SAMTEC, INC. THIS DOCUMENT SHALL NOT BE DISCLOSED, IN WHOLE OR PART, TO ANY UNAUTHORIZED PERSON OR ENTITY NOR REPRODUCED, TRANSFERRED OR INCORPORATED IN ANY OTHER PROJECT IN ANY MANNER WITHOUT THE EXPRESS WRITTEN CONSENT OF SAMTEC, INC.

MATERIAL:
VECTRA E130i, LCP, UL 94 VO
COLOR: BLACK
CONTACT: PHOS BRONZE, THICKNESS: .018

F:\DWG\MISC\MKTG\TFML-1XX-XX-XXX-D-XXX-MKT.SLDDRW

DO NOT SCALE DRAWING SHEET SCALE: 1.75:1

samtec
520 PARK EAST BLVD, NEW ALBANY, IN 47150
PHONE: 812-944-6733 FAX: 812-948-5047
e-Mail: info@SAMTEC.com code: 55322

DESCRIPTION: .050 SHROUDED TERMINAL ASSEMBLY
DWG. NO. TFML-1XX-XX-XXX-D-XXX
BY: DEANP 4/8/99 SHEET 1 OF 4

FIG 3

-02: SURFACE MOUNT
(SHOWN: TFML-125-02-XXX-D)
(SAME AS FIG 1, UNLESS OTHERWISE STATED)

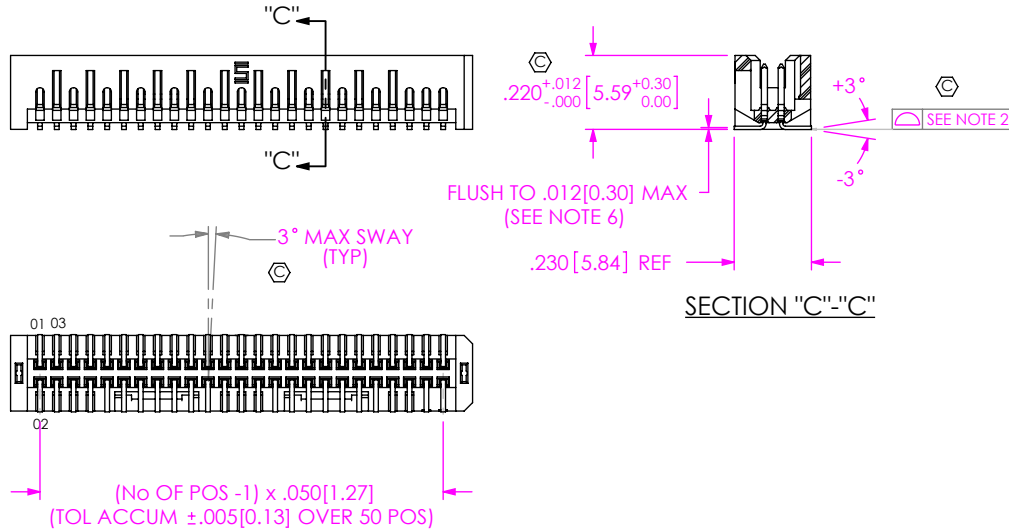

FIG 5

-P: PICK & PLACE PAD OPTION
(SHOWN: TFML-125-02-XXX-D-P)
(SAME AS FIG 1, UNLESS OTHERWISE STATED)
NOTCH ON PAD TO BE ON SAME END AS NOTCH IN TFM BODY

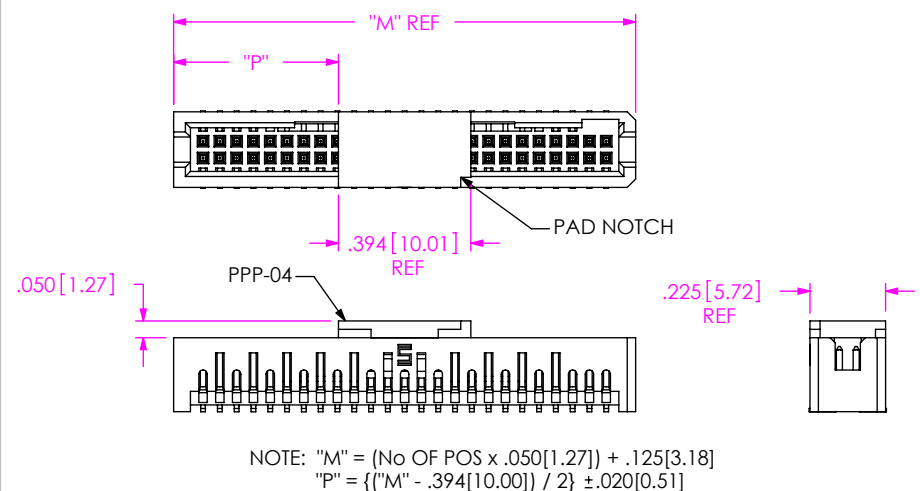

FIG 4

-RA: RIGHT ANGLE OPTION
(SHOWN: TFML-125-01-XXX-D-RA)
(SAME AS FIG 1, UNLESS OTHERWISE STATED)

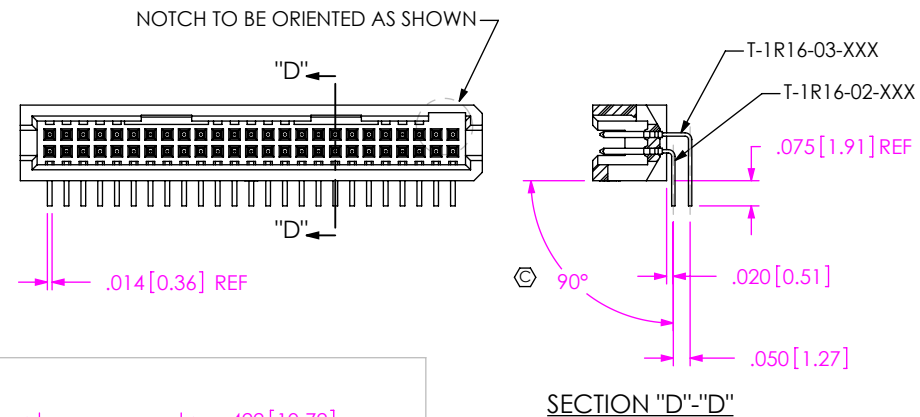
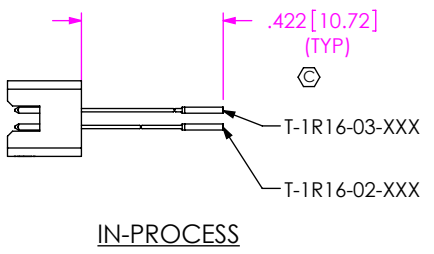
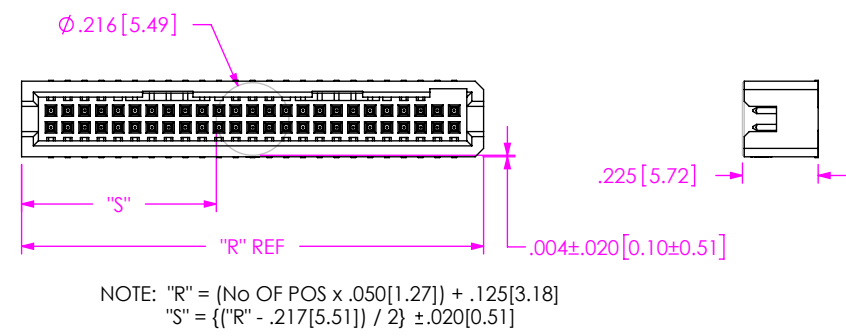

FIG 6

-K: POLYIMIDE FILM PAD OPTION
(SHOWN: TFML-125-02-XXX-D-K)
(SAME AS FIG 1, UNLESS OTHERWISE STATED)



F:\DWG\MISC\MKTG\TFML-1XX-XX-XXX-D-XXX-MKT.SLDDRW

PROPRIETARY NOTE
THIS DOCUMENT CONTAINS CONFIDENTIAL AND PROPRIETARY INFORMATION AND ALL DESIGN, MANUFACTURING, REPRODUCTION, USE, PATENT RIGHTS AND SALES RIGHTS ARE EXPRESSLY RESERVED BY SAMTEC, INC. THIS DOCUMENT SHALL NOT BE DISCLOSED, IN WHOLE OR PART, TO ANY UNAUTHORIZED PERSON OR ENTITY NOR REPRODUCED, TRANSFERRED OR INCORPORATED IN ANY OTHER PROJECT IN ANY MANNER WITHOUT THE EXPRESS WRITTEN CONSENT OF SAMTEC, INC.

DO NOT SCALE DRAWING
SHEET SCALE: 1:75:1

520 PARK EAST BLVD, NEW ALBANY, IN 47150
PHONE: 812-944-6733 FAX: 812-948-5047
e-Mail: info@SAMTEC.com code: 53322

DESCRIPTION:
.050 SHROUDED TERMINAL ASSEMBLY

DWG. NO.
TFML-1XX-XX-XXX-D-XXX

BY: DEANP 4/8/99 SHEET 2 OF 4

PACKAGING VIEWS

PARTS TO BE POSITIONED WITH POLARIZING NOTCH FACING THE SAMTEC LOGO AND ARROW.

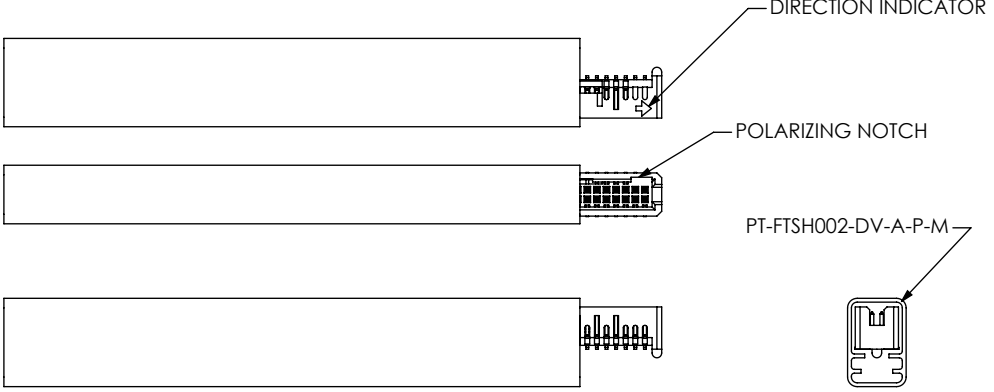

PARTS TO BE POSITIONED WITH TAILS FACING LOGO SIDE OF TUBE AND POLARIZING NOTCH ORIENTED AS SHOWN

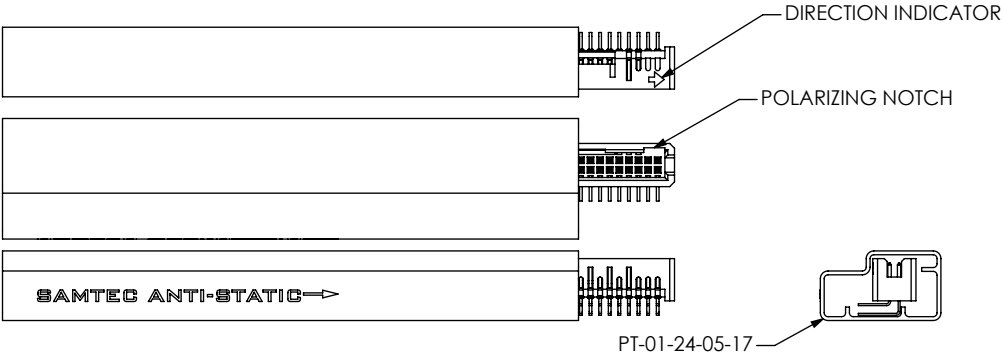

POSITION PARTS WITH POLARIZING NOTCH ORIENTED AS SHOWN

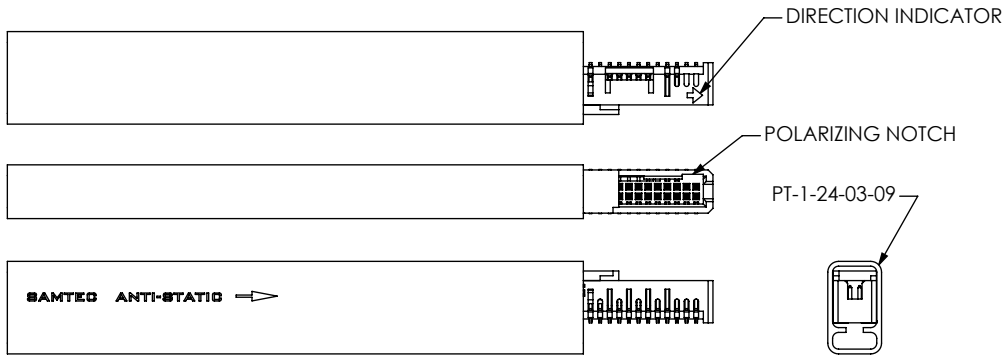

LEAD STYLE	PACKAGING TUBE	PLUG
-RA ONLY	PT-1-24-05-17	TP-07
-01,-02 EXCEPT -RA OR -P	PT-FTSH002-DV-A-P-M	TP-03
-01-P,-02-P	PT-1-24-03-09	TP-03

FIG 7

-A: ALIGNMENT PIN OPTION (SHOWN: TFML-125-02-XXX-D-A) (SAME AS FIG 1, UNLESS OTHERWISE STATED) -NOT AVAILABLE WITH -RA

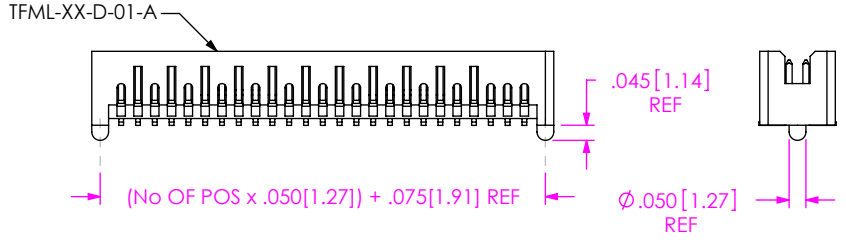

FIG 8

-SA: STAKED ALIGNMENT PIN OPTION (SHOWN: TFML-125-02-XXX-D-SA) (SAME AS FIG 1, UNLESS OTHERWISE STATED) -NOT AVAILABLE ON -RA

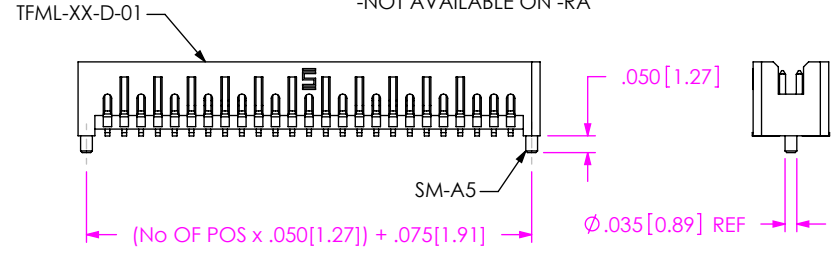
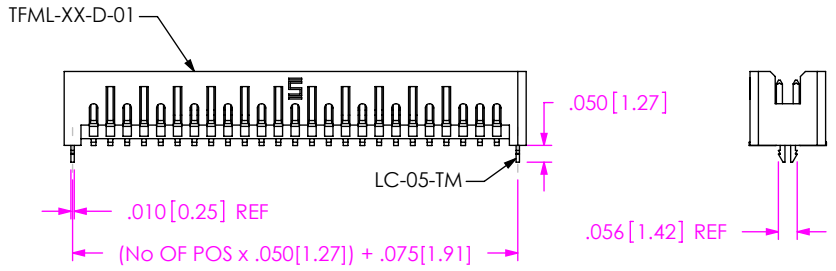

FIG 9

-LC: LOCKING CLIP OPTION (SHOWN: TFML-125-02-XXX-D-LC) (SAME AS FIG 1, UNLESS OTHERWISE STATED) -NOT AVAILABLE ON -RA



F:\DWG\MISC\MKTG\TFML-1XX-XX-XXX-D-XXX-MKT.SLDDRW

PROPRIETARY NOTE
 THIS DOCUMENT CONTAINS CONFIDENTIAL AND PROPRIETARY INFORMATION AND ALL DESIGN, MANUFACTURING, REPRODUCTION, USE, PATENT RIGHTS AND SALES RIGHTS ARE EXPRESSLY RESERVED BY SAMTEC, INC. THIS DOCUMENT SHALL NOT BE DISCLOSED, IN WHOLE OR IN PART, TO ANY UNAUTHORIZED PERSON OR ENTITY NOR REPRODUCED, TRANSFERRED OR INCORPORATED IN ANY OTHER PROJECT IN ANY MANNER WITHOUT THE EXPRESS WRITTEN CONSENT OF SAMTEC, INC.

DO NOT SCALE DRAWING

SHEET SCALE: 1:75:1



520 PARK EAST BLVD, NEW ALBANY, IN 47150
 PHONE: 812-944-6733 FAX: 812-948-5047
 e-Mail: info@SAMTEC.com code: 55322

DESCRIPTION:
 .050 SHROUDED TERMINAL ASSEMBLY

DWG. NO.
 TFML-1XX-XX-XXX-D-XXX

BY: DEANP 4/8/99 SHEET 3 OF 4

FIG 10
 -SNX: SOLDER NAIL
 (SHOWN: TFML-125-02-XXX-D-SN)
 (SAME AS FIG 1, UNLESS OTHERWISE STATED)
 (ONLY AVAILABLE ON -02 LEAD STYLE)

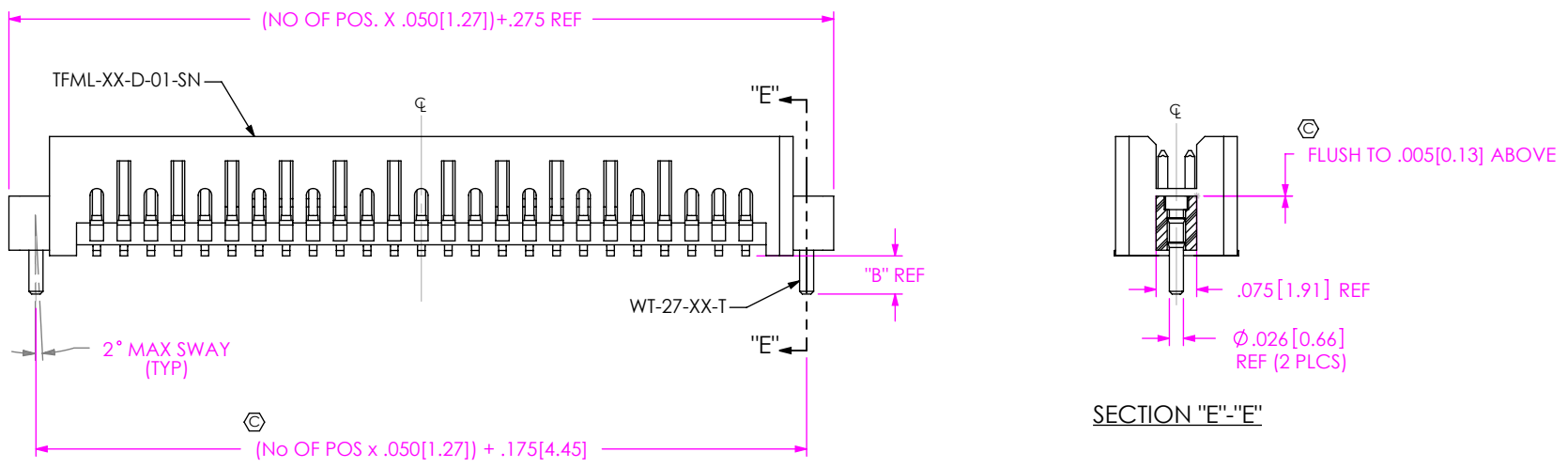



TABLE 2	
OPTION	"B"
-SN	.071 [1.80]
-SN2	.106 [2.69]

<p>PROPRIETARY NOTE</p> <p>THIS DOCUMENT CONTAINS CONFIDENTIAL AND PROPRIETARY INFORMATION AND ALL DESIGN, MANUFACTURING, REPRODUCTION, USE, PATENT RIGHTS AND SALES RIGHTS ARE EXPRESSLY RESERVED BY SAMTEC, INC. THIS DOCUMENT SHALL NOT BE DISCLOSED, IN WHOLE OR PART, TO ANY UNAUTHORIZED PERSON OR ENTITY NOR REPRODUCED, TRANSFERRED OR INCORPORATED IN ANY OTHER PROJECT IN ANY MANNER WITHOUT THE EXPRESS WRITTEN CONSENT OF SAMTEC, INC.</p> <p>DO NOT SCALE DRAWING</p> <p>SHEET SCALE: 3:1</p>		
	<p>520 PARK EAST BLVD, NEW ALBANY, IN 47150 PHONE: 812-944-6733 FAX: 812-948-5047 e-Mail: info@SAMTEC.com code: 55322</p>	
	<p>DESCRIPTION: .050 SHROUDED TERMINAL ASSEMBLY</p>	
	<p>DWG. NO. TFML-1 XX-XX-XXX-D-XXX</p>	
BY: DEANP	4/8/99	SHEET 4 OF 4