

May.1.2024 Copyright 2024 HIROSE ELECTRIC CO., LTD. All Rights Reserved.
 use of consideration for using Automotive equipment / device which demand high reliability, kindly contact our sales window correspond

COUNT	DESCRIPTION OF REVISIONS	B	Y	CHKD	DATE	COUNT	DESCRIPTION OF REVISIONS	B	Y	CHKD	DATE
2	RE-6-0742	LYJ	JHW		16. 09. 27	3	RE-6-1784	PSH	JHW		20. 04. 09
3	RE-6-0806	MSH	JHW		17. 01. 05						
1	RE-6-1137	KBJ	JHW		19. 02. 14						

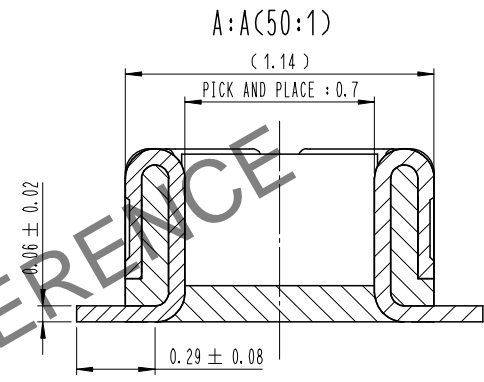

ENGAGEMENT FIGURE (50:1)

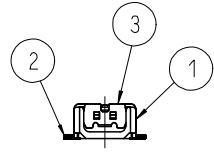
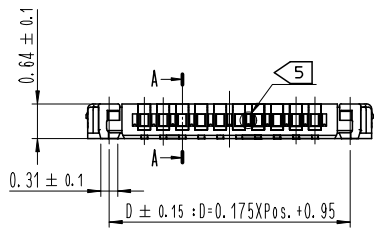
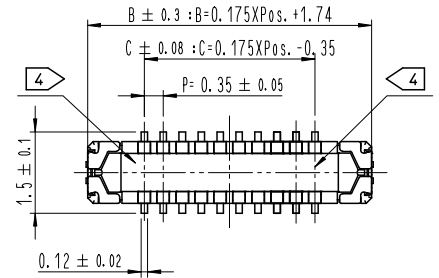
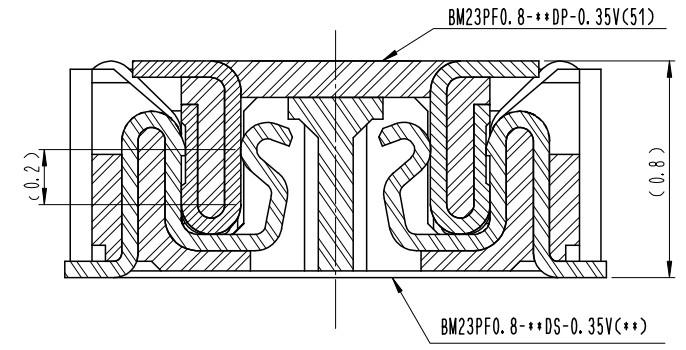

PART No.	CODE No.	POS.	B	C	D
BM23PF0.8-10DP-0.35V(51)	-	10	3.49	1.40	2.70
BM23PF0.8-14DP-0.35V(51)	-	14	4.19	2.10	3.40
BM23PF0.8-20DP-0.35V(51)	-	20	5.24	3.15	4.45
BM23PF0.8-24DP-0.35V(51)	-	24	5.94	3.85	5.15
BM23PF0.8-30DP-0.35V(51)	-	30	6.99	4.90	6.20
BM23PF0.8-40DP-0.35V(51)	-	40	8.74	6.65	7.95
BM23PF0.8-42DP-0.35V(51)	-	42	9.09	7.00	8.30
BM23PF0.8-44DP-0.35V(51)	-	44	9.44	7.35	8.65
BM23PF0.8-46DP-0.35V(51)	-	46	9.79	7.70	9.00
BM23PF0.8-50DP-0.35V(51)	-	50	10.49	8.40	9.70
BM23PF0.8-54DP-0.35V(51)	-	54	11.19	9.10	10.40
BM23PF0.8-64DP-0.35V(51)	-	64	12.94	10.85	12.15

- NOTE
- ALL LEAD CO-PLANARITY SHALL BE 0.08mm MAX.
 - CONTACT PLATING SPECIFICATIONS.
 CONTACT AREA : GOLD 0.05 μm MIN.
 SMT LEAD : GOLD 0.05 μm MIN.
 UNDER PLATING : NICKEL 1 μm MIN.
 (SURFACE : SEALING)
 - METAL FITTING PLATING SPECIFICATIONS.
 SMT LEAD : GOLD 0.05 μm MIN.
 UNDERPLATING : NICKEL 1 μm MIN.
 (SURFACE : SEALING)
 - HRS MARK AND CAV No. ARE INDICATED IN APPROX POSITION SHOWN.
 - A PART OF THE WALL COULD BE NOTCHED.

4	PS	CLEAR (EMBOSSED CARRIER TAPE)								
3	COOPER ALLOY	3	7	PS	CLEAR(REINFORCEMENT COLLAR)					
2	COOPER ALLOY	2	6	PS	BLACK (PLASTIC REEL)					
1	LCP	UL94 V-0, BLACK	5	POLYESTER	CLEAR (COVER TAPE)					
NO.	MATERIAL	FINISH, REMARKS	NO.	MATERIAL	FINISH, REMARKS					
REMARKS						DRAWN	DESIGNED	CHECKED	APPROVED	RELEASED
						J. S. JANG	J. S. JANG	H. W. JO	H. W. JO	20.10.06
						20.10.06	20.10.06	20.10.06	20.10.06	
CODE NO. (OLD)	DRAWING NO. EDC3-*****				PART NO. BM23PF0.8-54DP-0.35V(51)					
SCALE 10:1	HRS HIROSE KOREA CO., LTD.				CODE NO. CL 66*-*****-51					
UNITS mm							1/3			

7 RECOMMENDED PCB LAYOUT

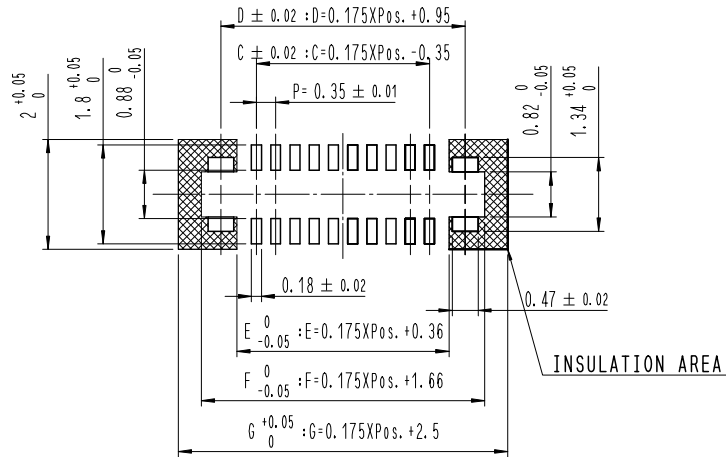

RECOMMENDED METAL MASK DIMENSIONS

METAL MASK THICKNESS : 100 μm

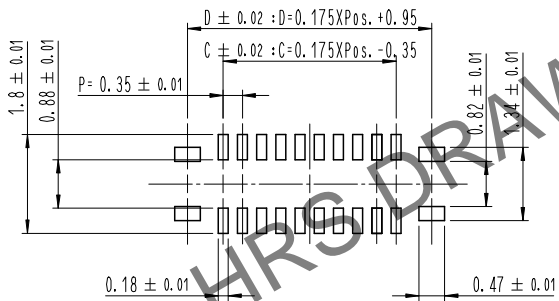

POS.	C	D	E	F	G
10	1.40	2.70	2.11	3.41	4.25
14	2.10	3.40	2.81	4.11	4.95
20	3.15	4.45	3.86	5.16	6.00
24	3.85	5.15	4.56	5.86	6.70
30	4.90	6.20	5.61	6.91	7.75
40	6.65	7.95	7.36	8.66	9.50
42	7.00	8.30	7.71	9.01	9.85
44	7.35	8.65	8.06	9.36	10.20
46	7.70	9.00	8.41	9.71	10.55
50	8.40	9.70	9.11	10.41	11.25
54	9.10	10.40	9.81	11.11	11.95
64	10.85	12.15	11.56	12.86	13.70

6 RECOMMENDED REFLOW TEMPERATURE PROFILE USING LEAD-FREE SOLDER PASTE.

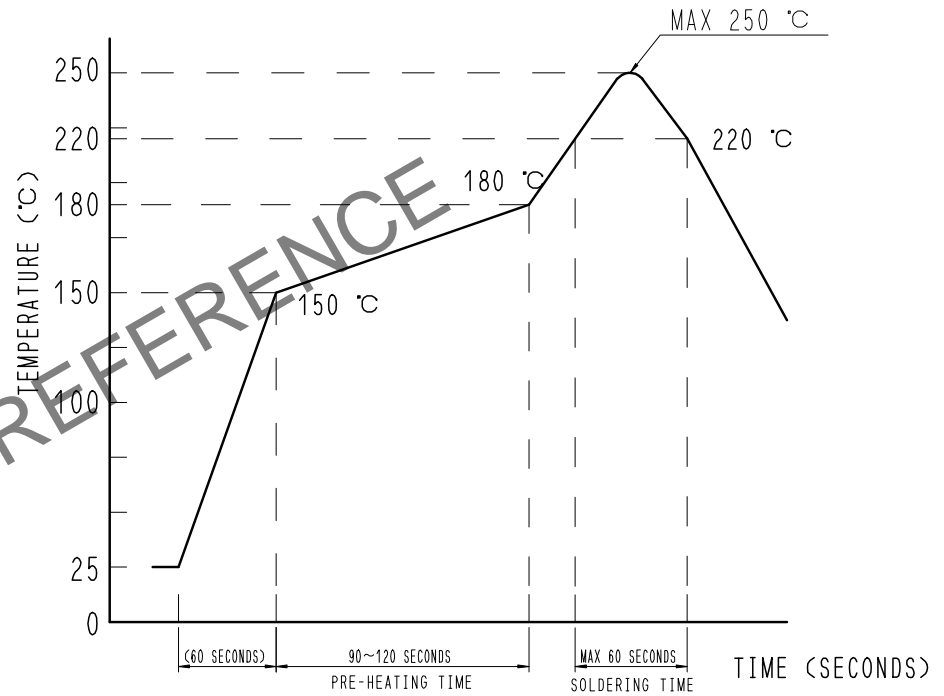

REFLOW METHOD: N₂ REFLOW
 NUMBER OF REFLOW CYCLES: 2 CYCLES MAX.

- 1) REFLOW TIME
 DURATION ABOVE 220°C: 60 SEC MAX.
 (PEAK TEMPERATURE: 250°C MAX)
- 2) PRE-HEAT TIME
 PRE-HEAT TEMPERATURE(MIN): 150°C
 PRE-HEAT TEMPERATURE(MAX): 180°C
 PRE-HEAT TIME: 90-120 SEC.

- 6 THIS TEMPERATURE PROFILE IS PER THE CONDITIONS SHOWN ABOVE. ADDITIONAL FACTORS, SUCH AS SOLDER PASTE TYPE, PCB SIZE AND OTHER MOUNTED COMPONENTS COULD AFFECT THE PROFILE. THEREFORE, A THOROUGH EVALUATION OF MOUNTING CONDITION IS REQUIRED PRIOR TO PRODUCTION. TEMPERATURE IS MEASURED AT CONTACT LEAD.
- 7 PLEASE CONTACT US IN CASE YOU WILL MAKE DIFFERENT SETTINGS FROM OUR RECOMMENDATION.

 SCALE 10:1 UNITS mm	DRAWING NO. EDC3-*****	PART NO. BM23PFO.8-**-DP-0.35V(51)
	 HIROSE KOREA CO., LTD.	CODE NO CL 66**-**-51

May.1.2024 Copyright 2024 HIROSE ELECTRIC CO., LTD. All Rights Reserved.
 use of consideration for using Automotive equipment / device which demand high reliability, kindly contact our sales window correspond

EMBOSSED CARRIER TAPE PACKAGING (5:1)

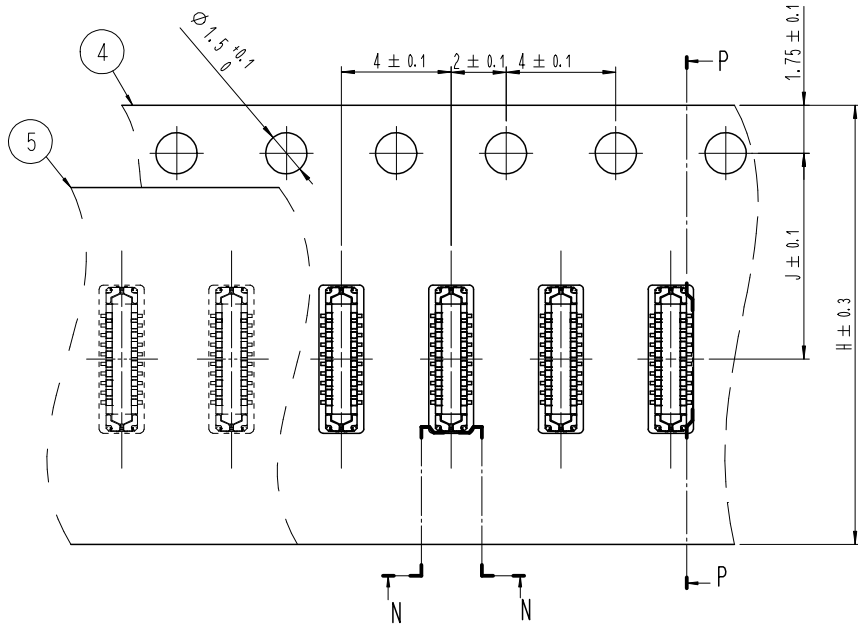

P-P (5:1)

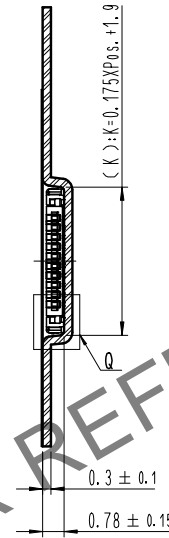

STYLE AND DIMENTION OF REEL (FREE)

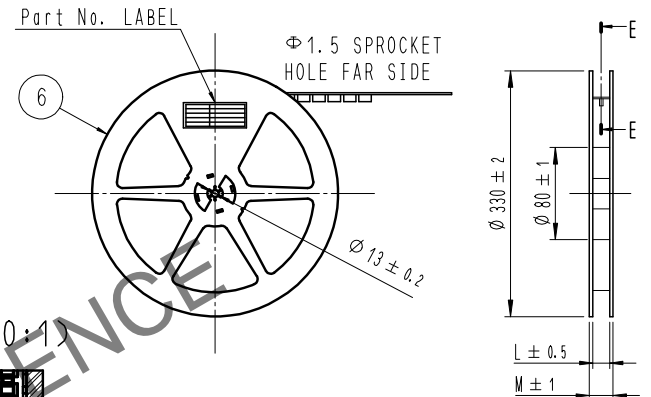

DIRECTION OF UNREELING

N-N (5:1)

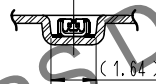

TAPING (FREE)

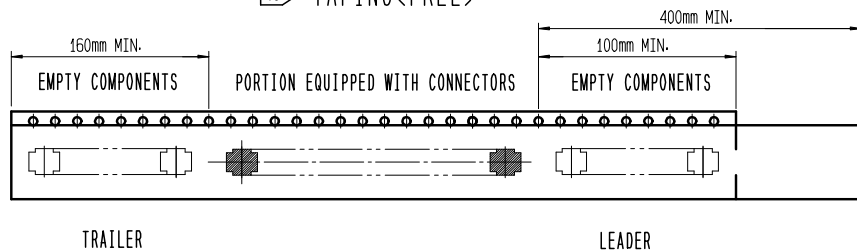

POS.	H	J	K	L	M
10	12	5.5	3.65	13.5	17.5
14	16	7.5	4.35	17.5	21.5
20	16	7.5	5.40	17.5	21.5
24	16	7.5	6.10	17.5	21.5
30	16	7.5	7.15	17.5	21.5
40	24	11.5	8.90	25.5	29.5
42	24	11.5	9.25	25.5	29.5
44	24	11.5	9.60	25.5	29.5
46	24	11.5	9.95	25.5	29.5
50	24	11.5	10.65	25.5	29.5
54	24	11.5	11.35	25.5	29.5
64	24	11.5	13.10	25.5	29.5

E-E (FREE)

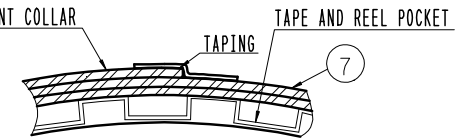

DETAIL OF PART No. LABEL

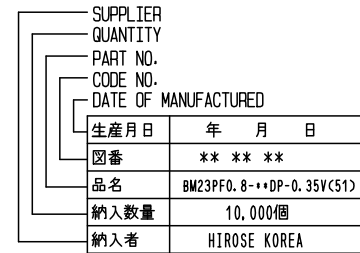

8 . PER REEL 10,000 CONNECTORS.

9 . THE DIMENSIONS IN PARENTHESES ARE FOR REFERENCE.

10 REFER TO JIS C 0806, IEC-60286-3 (PACKAGING OF COMPONENTS FOR AUTOMATIC HANDLING)

11 AFTER PACKAGING, ROLL 2 METERS OF THE REINFORCEMENT COLLAR TO OUTER CIRCUMFERENCE OF TAPE AND REEL POCKET, AND TAPE DOWN AT THE END THE COLLAR.

 SCALE 10:1 UNITS	DRAWING NO. EDC3-*****	PART NO. BM23PF0.8-**-DP-0.35V(51)
	 HIROSE KOREA CO., LTD.	CODE NO. CL 66**-*****-51