

CHIPLINK N-Channel Enhancement Mode Power MOSFET

Description

The LX3400L combines advanced trench technology to provide excellent $R_{DS(ON)}$, low gate charge and operation with gate voltage as low as 2.5V. This device is suitable for use as a load switch or PWM applications.

Features

- $V_{DS}=30V$, $I_D=5.1A$
 $R_{DS(ON)} < 33m\Omega @ V_{DS}=10V$
 $R_{DS(ON)} < 39m\Omega @ V_{DS}=4.5V$
 $R_{DS(ON)} < 55m\Omega @ V_{DS}=2.5V$
- Low gate charge
- High power and current handling capability
- Termination is Lead-free and RoHS Compliant



Applications

- PWM applications
- Load switch
- Power Management

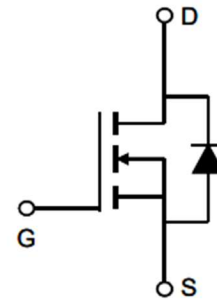

schematic diagram

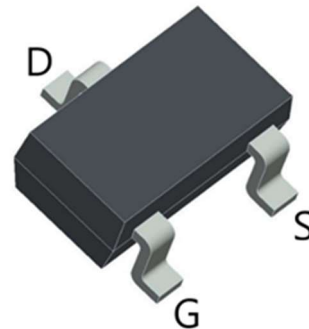

SOT23-3L Package

Maximum Ratings ($T_A=25^\circ C$ unless otherwise noted)

Parameter	Symbol	Maximum	Units
Drain-Source Voltage	V_{DS}	30	V
Gate-Source Voltage	V_{GS}	± 12	V
Continuous Drain Current	I_D	5.1	A
Pulsed Drain Current ^B	I_{DM}	20	A
Maximum Power Dissipation ^A	P_D	1.3	W
Junction and Storage Temperature Range	T_J, T_{STG}	-55 To 150	$^\circ C$

Thermal Characteristic

Thermal Resistance, Junction to Ambient	R_{QJA}	96	$^\circ C/W$
---	-----------	----	--------------

Electrical Characteristics ($T_A=25^{\circ}\text{C}$ unless otherwise specified)

Parameter	Symbol	Test conditions	MIN	TYP	MAX	UNIT
Drain-Source Breakdown Voltage	BV_{DSS}	$V_{GS}=0V, I_D=250\mu A$	30			V
Gate-Threshold Voltage	$V_{th(GS)}$	$V_{DS}=V_{GS}, I_D=250\mu A$	0.7	0.9	1.2	V
Gate-body Leakage	I_{GSS}	$V_{DS}=0V, V_{GS}=\pm 12V$			± 100	nA
Zero Gate Voltage Drain Current	I_{DSS}	$V_{DS}=30V, V_{GS}=0V$			1	μA
Drain-Source On-Resistance	$R_{DS(ON)}$	$V_{GS}=10V, I_D=5A$		24	33	m Ω
		$V_{GS}=4.5V, I_D=4A$		26	39	m Ω
		$V_{GS}=2.5V, I_D=3A$		33	55	m Ω
Forward Transconductance	g_{FS}	$V_{DS}=5V, I_D=5A$	10			S
Dynamic Characteristics						
Input Capacitance	C_{ISS}	$V_{DS}=15V, V_{GS}=0V, F=1MHz$		595		μF
Output Capacitance	C_{OSS}			39		
Reverse Transfer Capacitance	C_{RSS}			36		
Switching Capacitance						
Turn-on Delay Time	$t_{d(on)}$	$V_{DD}=15V, R_L=3\Omega, V_{GS}=10V, R_{GEN}=3\Omega$		3.0		nS
Turn-on Rise Time	t_r			4.5		nS
Turn-off Delay Time	$t_{d(off)}$			25		nS
Turn-off Fall Time	t_f			3.8		nS
Total Gate Charge	Q_g	$V_{DS}=15V, I_D=5A, V_{GS}=4.5V$		9.3		nC
Gate-Source Charge	Q_{gs}			1.6		nC
Gate-Drain Charge	Q_{gd}			2.1		nC
Drain-Source Diode Characteristics						
Diode Forward Voltage	V_{SD}	$V_{GS}=0V, I_D=5A$			1.2	V
Diode Forward Current	I_S				5.1	A

Notes:

- The Power dissipation P_D is based on $T_{J(MAX)}=150^{\circ}\text{C}$, using $\leq 10s$ junction-to ambient thermal resistance.
- Repetitive rating, pulse width limited by junction temperature $T_{J(MAX)}=150^{\circ}\text{C}$. Ratings are based on low frequency and duty cycles to keep initial $T_J=25^{\circ}\text{C}$.
- The Static characteristics in Figures are obtained using $< 300\mu s$ pulses, duty cycle 2% max.

Typical Electrical and Thermal Characteristics

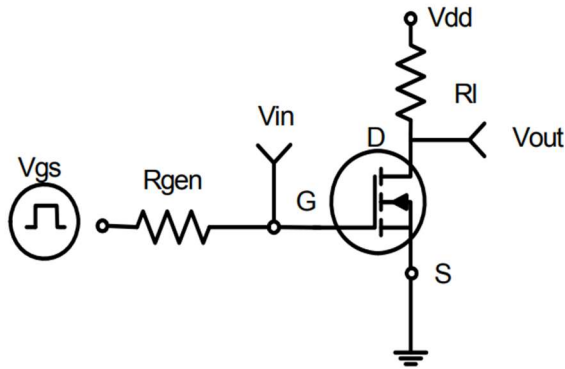

Figure 1: Switching Test Circuit

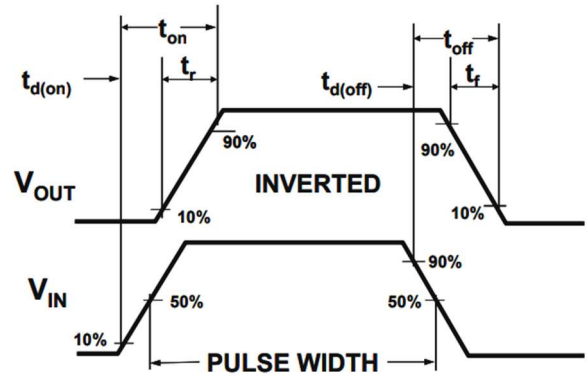
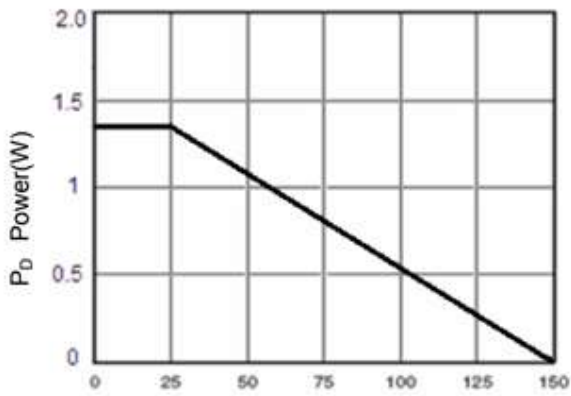
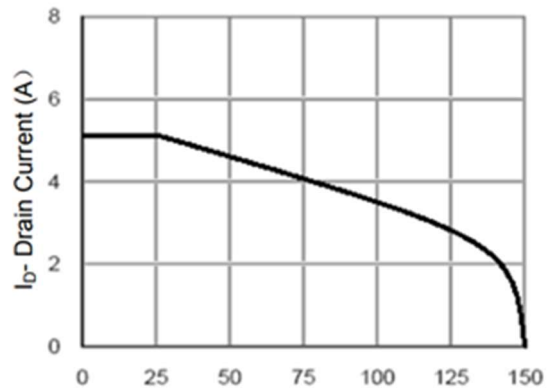

Figure 2: Switching Waveforms



T_J-Junction Temperature(°C)
Figure 3 Power Dissipation



T_J-Junction Temperature(°C)
Figure 4 Drain Current

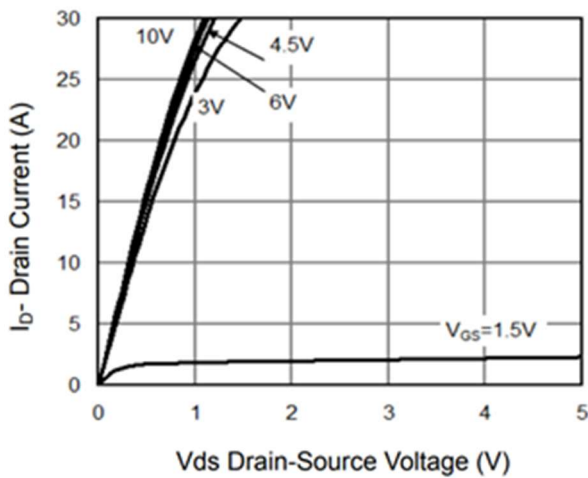

V_{ds} Drain-Source Voltage (V)
Figure 5 Output Characteristics

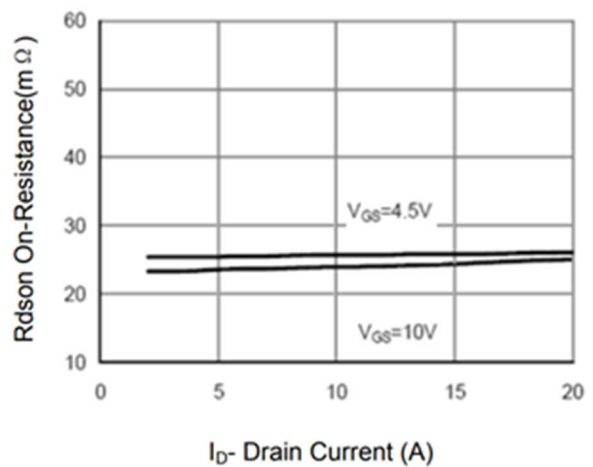

I_D- Drain Current (A)
Figure 6 Drain-Source On-Resistance

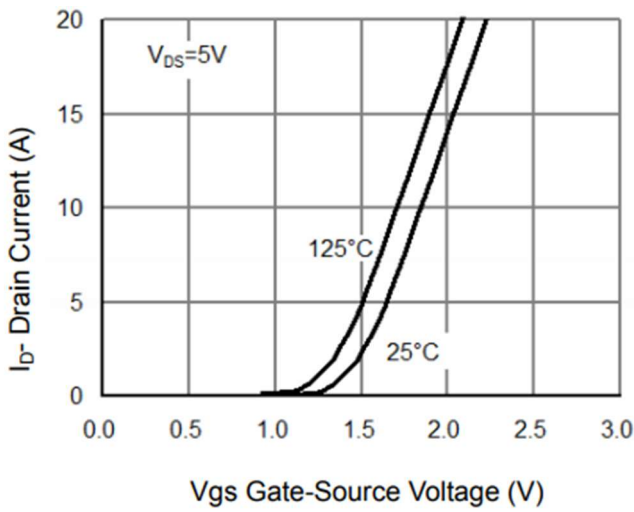

Figure 7 Transfer Characteristics

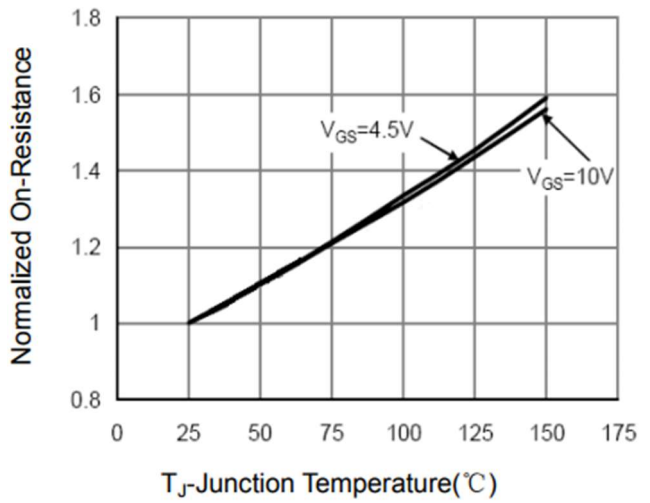

Figure 8 Drain-Source On-Resistance

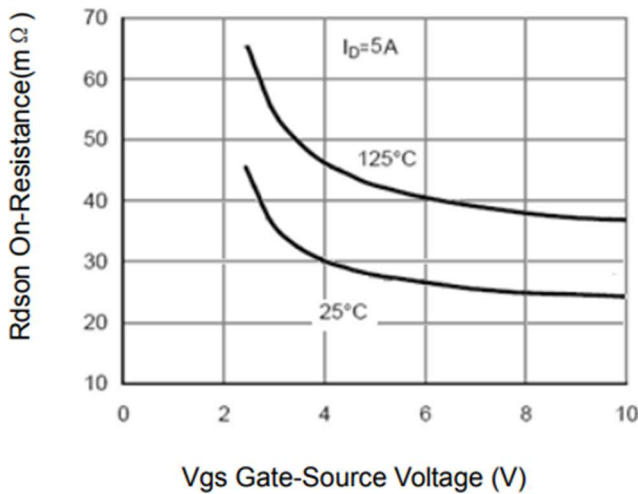

Figure 9 Rdson vs Vgs

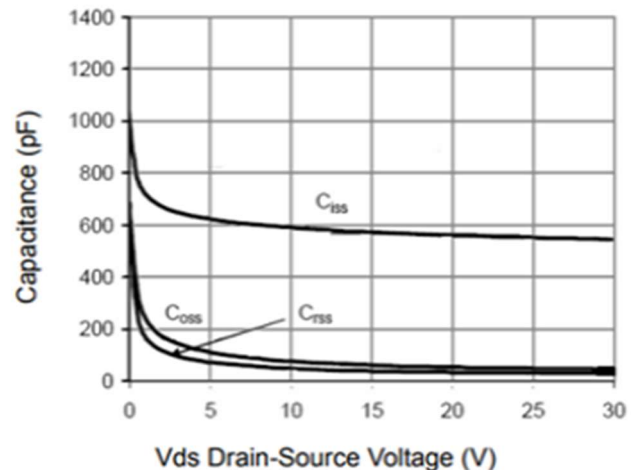

Figure 10 Capacitance vs Vds

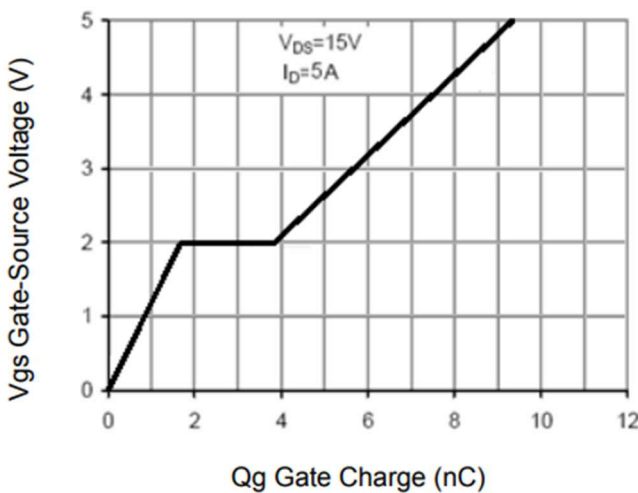

Figure 11 Gate Charge

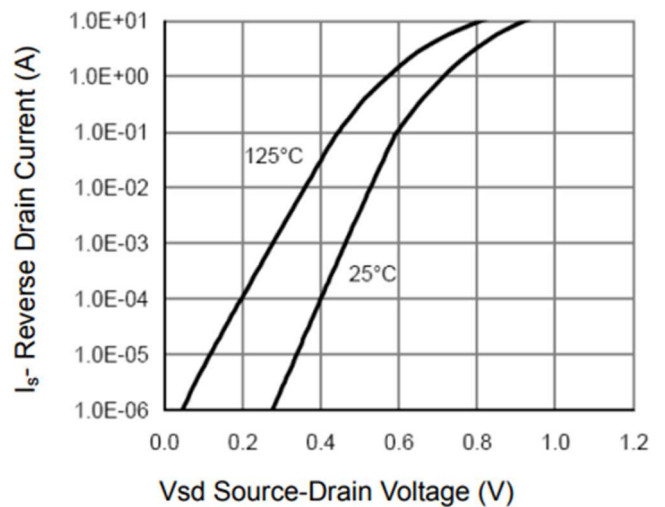

Figure 12 Source- Drain Diode Forward

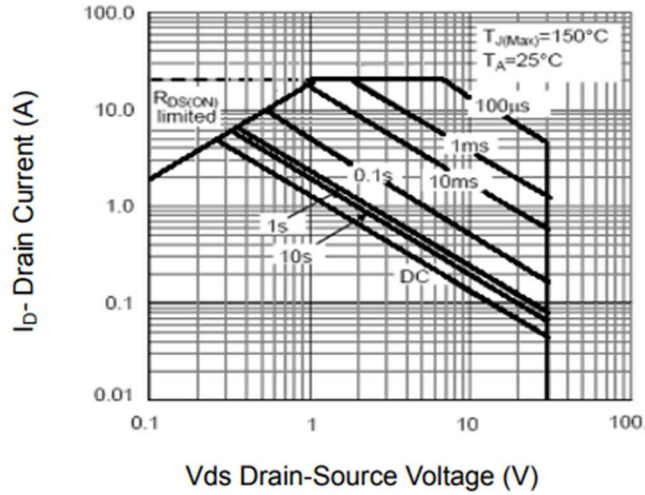

Figure 13 Safe Operation Area

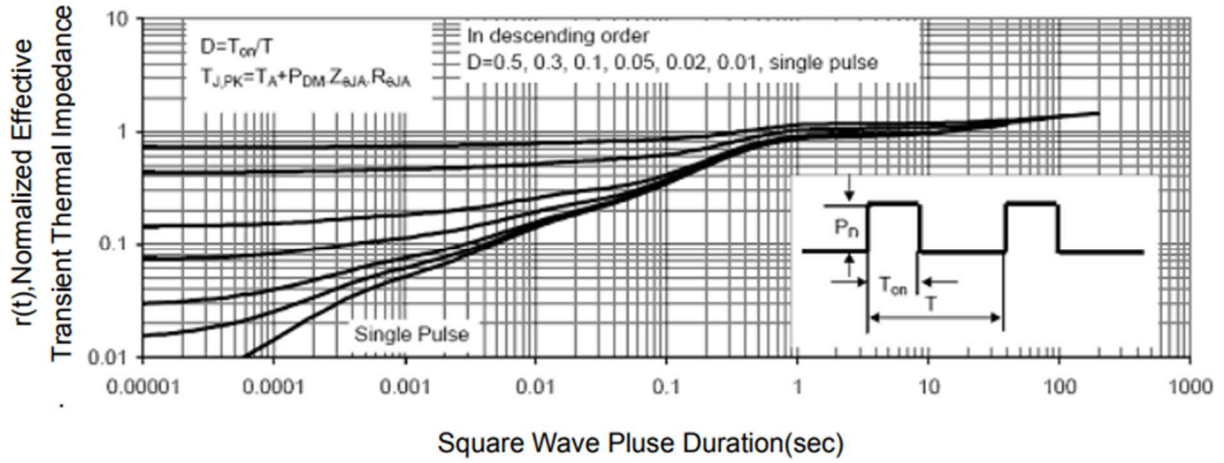
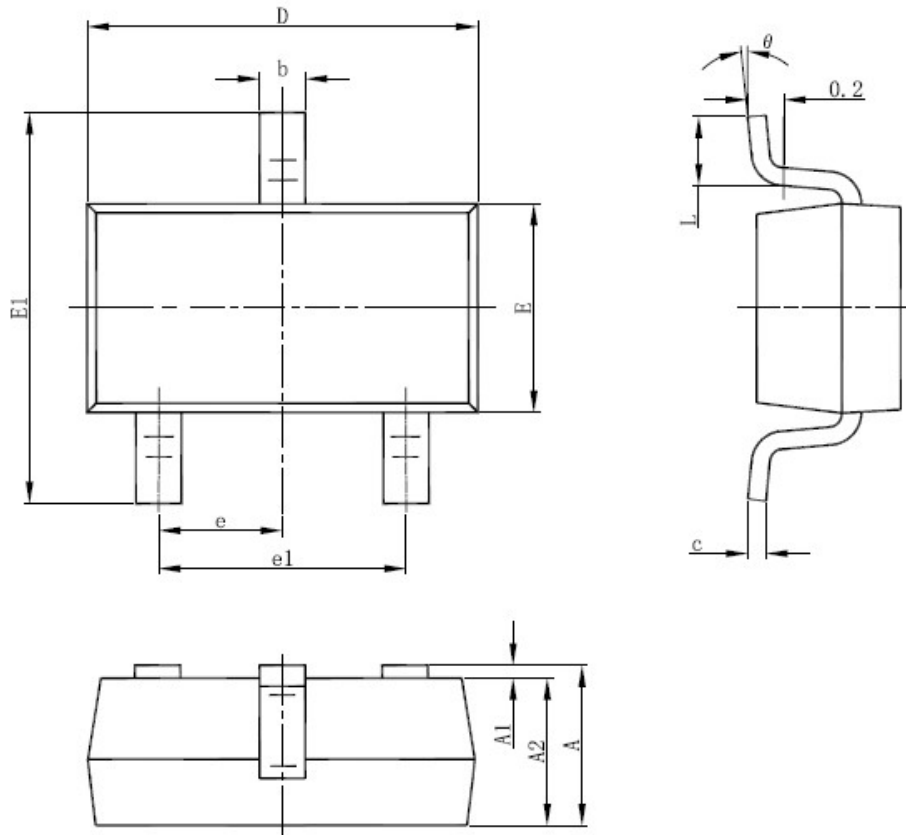

Figure 14 Normalized Maximum Transient Thermal Impedance

SOT23-3L Package Information

Symbol	Dimensions In Millimeters		Dimensions In Inches	
	Min	Max	Min	Max
A	1.050	1.250	0.041	0.049
A1	0.000	0.100	0.000	0.004
A2	1.050	1.150	0.041	0.045
b	0.300	0.500	0.012	0.020
c	0.100	0.200	0.004	0.008
D	2.820	3.020	0.111	0.119
E	1.500	1.700	0.059	0.067
E1	2.650	2.950	0.104	0.116
e	0.950(BSC)		0.037(BSC)	
e1	1.800	2.000	0.071	0.079
L	0.300	0.600	0.012	0.024
θ	0°	8°	0°	8°

THIS PRODUCT HAS BEEN DESIGNED AND QUALIFIED FOR THE CONSUMER MARKET. APPLICATIONS OR USES AS CRITICAL COMPONENTS IN LIFE SUPPORT DEVICES OR SYSTEMS ARE NOT AUTHORIZED.

CHIPLINK DOES NOT ASSUME ANY LIABILITY ARISING OUT OF SUCH APPLICATIONS OR USES OF ITS PRODUCTS.

THIS DOCUMENT SUPERSEDES AND REPLACES ALL INFORMATION PREVIOUSLY SUPPLIED. CHIPLINK RESERVES THE RIGHT TO IMPROVE PRODUCT DESIGN, FUNCTIONS AND RELIABILITY WITHOUT NOTICE.