

CJ75LXXS

INTRODUCTION

The CJ75LXXS series are a group of positive voltage regulators manufactured by CMOS technologies with low power consumption and low dropout voltage, which provide large output currents even when the difference of the input-out-put voltage is small.

The CJ75LXXS series can deliver 300 mA output current and allow an input voltage as high as 36V. The series are very suitable for the battery powered equipments, such as RF applications and other systems requiring a quiet voltage source.

FEATURES

- Low Quiescent Current: 2 μ A
- Operating Voltage Range: 2.5V~36V
- Output Current: 300mA
- Low Dropout Voltage:
200mV@100mA($V_{OUT}=3.3V$)
- Output Voltage: 1.2~ 12V
- High Accuracy: $\pm 2\%$ (Typ.)
- High Power Supply Rejection Ratio:
70dB@1kHz
- Low Output Noise:
27x V_{OUT} μ V_{RMS}(10Hz~100kHz)
- Excellent Line and Load Transient Response
- Built-in Current Limiter, Short-Circuit Protection
- Over-Temperature Protection

BLOCK DIAGRAM

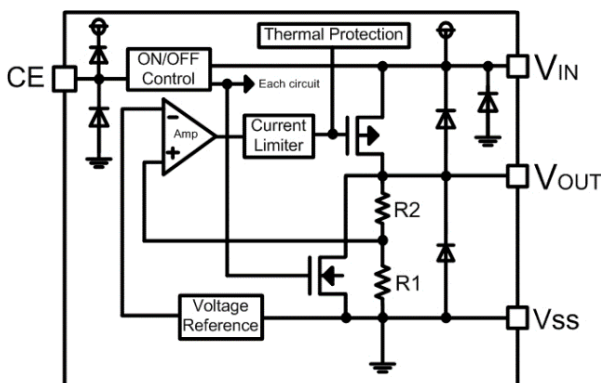

SOT-23

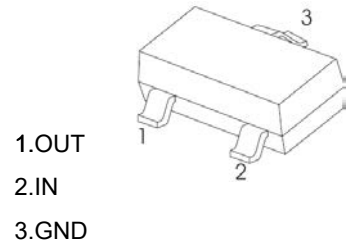

APPLICATIONS

- Cordless Phones
- Radio control systems
- Laptop, Palmtops and PDAs
- Single-lens reflex DSC
- PC peripherals with memory
- Wireless Communication Equipments
- Portable Audio Video Equipments
- Car Navigation Systems
- LAN Cards
- Ultra Low Power Microcontrollers

TYPICAL APPLICATION CIRCUIT

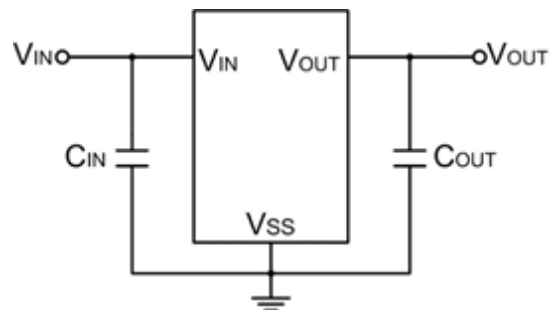

For CJ75LXXS series, input and output capacitors are required to achieve stability and help the equipment obtain better transient response and PSRR. It is recommended to use 1 μ F input and 1 μ F output capacitors.

Electrical Characteristics

ABSOLUTE MAXIMUM RATINGS

(Unless otherwise specified, $T_A=25^{\circ}\text{C}$)

PARAMETER	SYMBOL	RATINGS	UNITS
Input Voltage ⁽²⁾	V_{IN}	-0.3~40	V
Output Voltage ⁽²⁾	V_{OUT}	-0.3~13	V
Power Dissipation	P_D	0.6	W
Operating Ambient Temperature Range	T_A	-40~+85	$^{\circ}\text{C}$
Operating Junction Temperature Range ⁽³⁾	T_j	-40~+125	$^{\circ}\text{C}$
Storage Temperature	T_{stg}	-40~+125	$^{\circ}\text{C}$
Lead Temperature(Soldering, 10 sec)	T_{solder}	260	$^{\circ}\text{C}$
ESD rating	Human Body Model -(HBM)	2	kV
	Machine Model- (MM)	200	V

(1) Stresses beyond those listed under *absolute maximum ratings* may cause permanent damage to the device. These are stress ratings only, and functional operation of the device at these or any other conditions beyond those indicated under *recommended operating conditions* is not implied. Exposure to absolute-maximum-rated conditions for extended periods may affect device reliability.

(2) All voltages are with respect to network ground terminal.

(3) This IC includes over temperature protection that is intended to protect the device during momentary overload. Junction temperature will exceed 125°C when over temperature protection is active. Continuous operation above the specified maximum operating junction temperature may impair device reliability.

RECOMMENDED OPERATING CONDITIONS

PARAMETER	MIN.	NOM.	MAX.	UNITS
Supply voltage at V_{IN}	2.5		36	V
Operating junction temperature range, T_j	-40		125	$^{\circ}\text{C}$
Operating free air temperature range, T_A	-40		85	$^{\circ}\text{C}$

Electrical Characteristics

ELECTRICAL CHARACTERISTICS

(Unless otherwise specified, TA=25°C)

PARAMETER	SYMBOL	CONDITIONS	MIN.	TYP. ⁽⁴⁾	MAX.	UNITS	
Input Voltage	V _{IN}		2.5	—	36	V	
Output Voltage Range	V _{OUT}		2.1	—	12	V	
DC Output Accuracy		I _{OUT} =1mA	-2	—	2	%	
Dropout Voltage	V _{dif} ⁽⁵⁾	I _{OUT} =100mA, V _{OUT} =3.3V	—	200	—	mV	
Supply Current	I _{SS}	I _{OUT} =0A	1.2≤V _{OUT} ≤7.0V	—	2	5	μA
			7.0<V _{OUT} ≤12V	—	3	6	μA
Line Regulation	$\frac{\Delta V_{OUT}}{V_{OUT} \times \Delta V_{IN}}$	I _{OUT} =10mA V _{OUT} +1V≤V _{IN} ≤36V	—	0.01	0.3	%/V	
Load Regulation	ΔV_{OUT}	V _{IN} = V _{OUT} +1V, 1mA≤I _{OUT} ≤100mA	—	10	—	mV	
Temperature Coefficient	$\frac{\Delta V_{OUT}}{V_{OUT} \times \Delta T_A}$	I _{OUT} =10mA, -40°C<T _J <125°C		50		ppm	
Output Current Limit	I _{LIM}	V _{OUT} = 0.5 x V _{OUT(Normal)} , V _{IN} =5.0V	350	600		mA	
Short Current	I _{SHORT}	V _{OUT} =V _{SS}	—	100	—	mA	
Power Supply Rejection Ratio	PSRR	I _{OUT} =50mA	100Hz	—	75	—	dB
			1kHz	—	70	—	
			10kHz	—	55	—	
			100kHz	—	40	—	
Output Noise Voltage	V _{ON}	BW=10Hz to 100kHz	—	27 x V _{OUT}	—	μV _{RMS}	
Thermal Shutdown Temperature	T _{SD}	—	—	160	—	°C	
Thermal Shutdown Hysteresis	ΔT _{SD}	—	—	20	—	°C	

(4) Typical numbers are at 25°C and represent the most likely norm.

(5)V_{dif}: The Difference Of Output Voltage And Input Voltage When Input Voltage Is Decreased Gradually Till Output Voltage Equals To 98% Of V_{OUT} (E).

MODEL DEFINITION INFORMATION

Model	Output Voltage
CJ75L033S	3.3V
CJ75L05S	5.0V
CJ75LC0S	12.0V

Typical Characteristics

(Unless otherwise specified, $T_A=25^\circ\text{C}$)

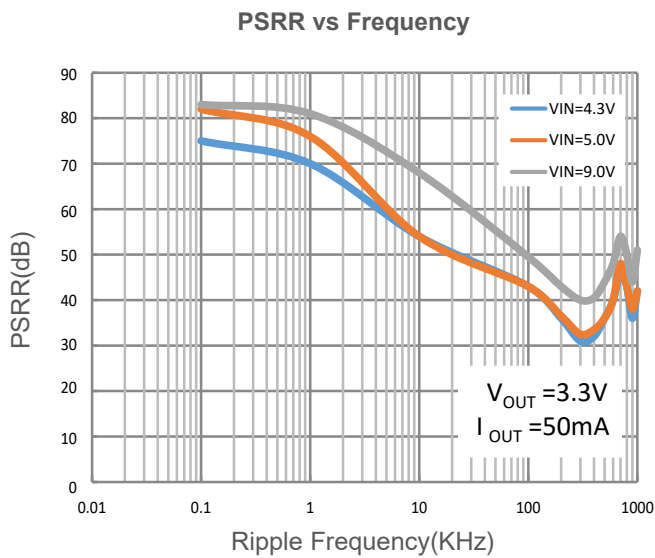
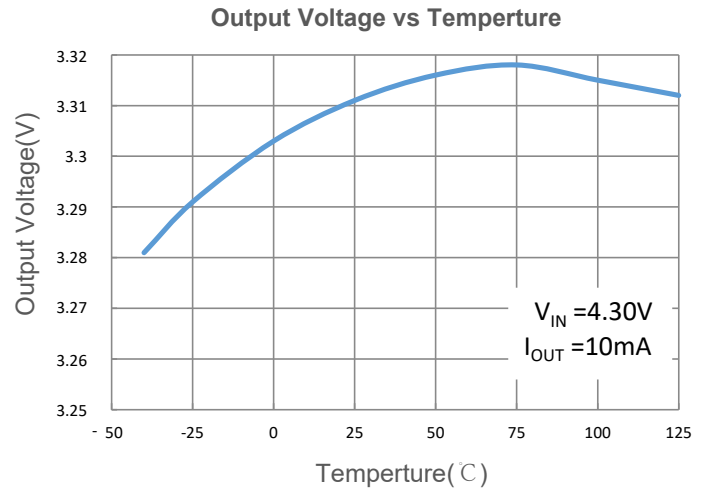
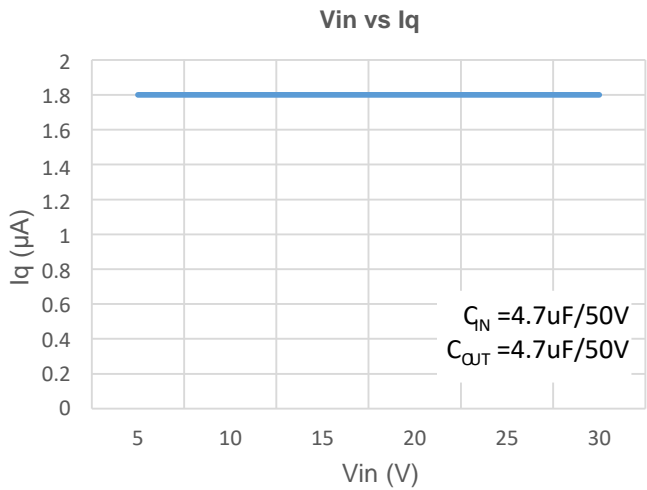
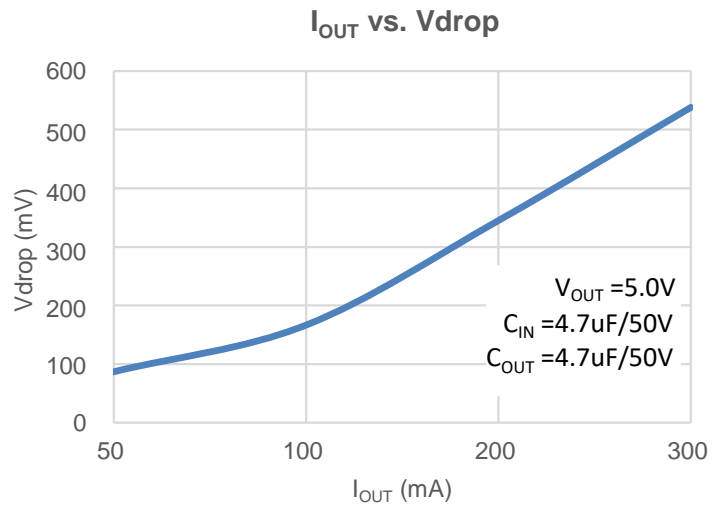
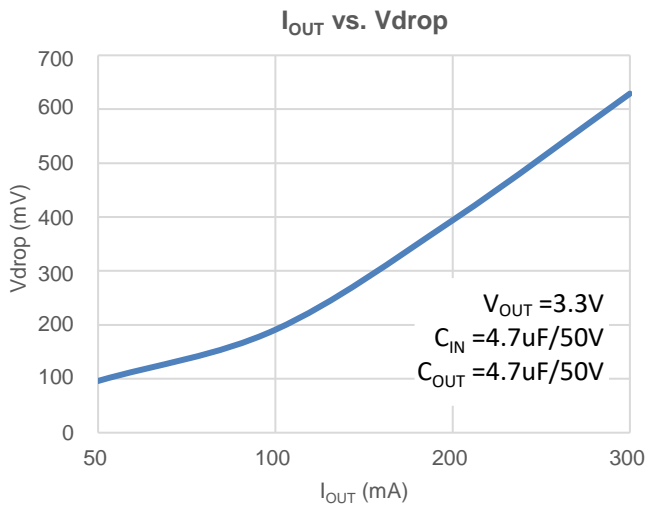

Typical Characteristics

(Unless otherwise specified, $T_A=25^{\circ}\text{C}$)

Power Up Response

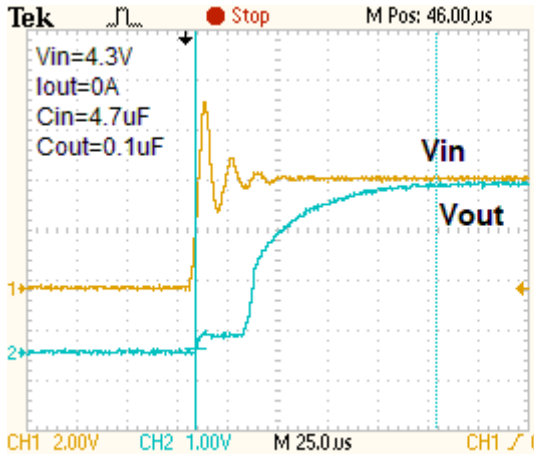

Power Up Response

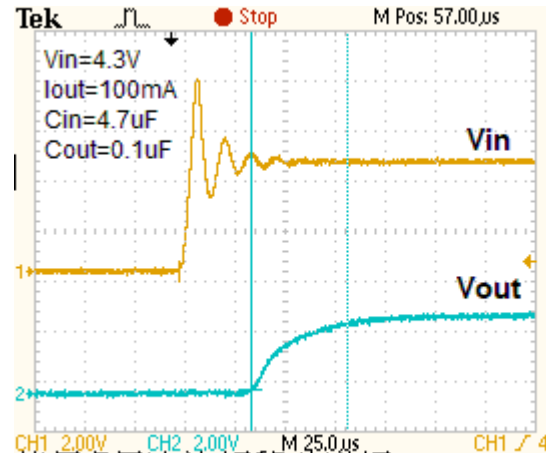

Load Transient Response

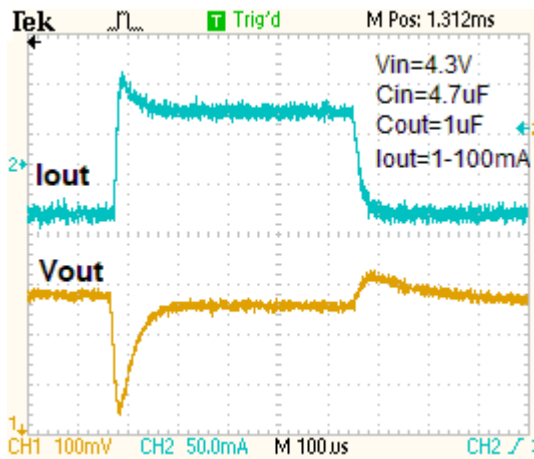

Load Transient Response

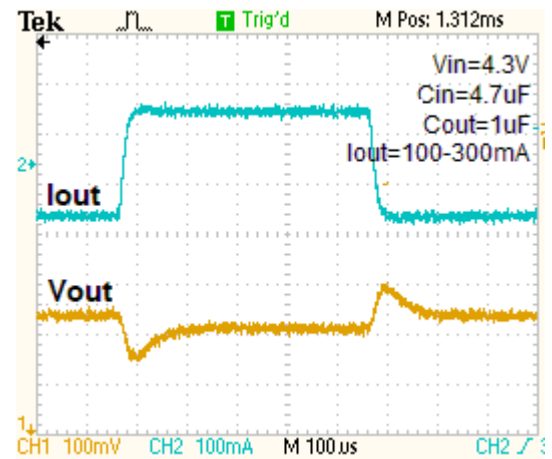

SOT-23 Package Outline Dimensions

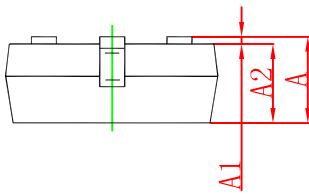
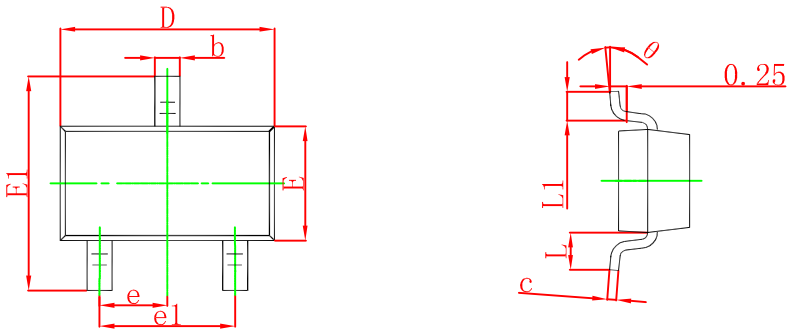

Symbol	Dimensions In Millimeters		Dimensions In Inches	
	Min	Max	Min	Max
A	0.900	1.150	0.035	0.045
A1	0.000	0.100	0.000	0.004
A2	0.900	1.050	0.035	0.041
b	0.300	0.500	0.012	0.020
c	0.080	0.150	0.003	0.006
D	2.800	3.000	0.110	0.118
E	1.200	1.400	0.047	0.055
E1	2.250	2.550	0.089	0.100
e	0.950 TYP		0.037 TYP	
e1	1.800	2.000	0.071	0.079
L	0.550 REF		0.022 REF	
L1	0.300	0.500	0.012	0.020
θ	0°	8°	0°	8°

SOT-23 Suggested Pad Layout

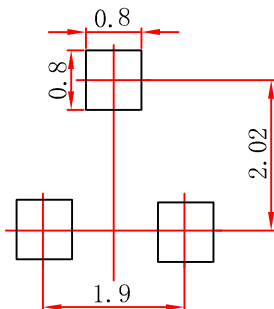

Note:

1. Controlling dimension: in millimeters.
2. General tolerance: ± 0.05 mm.
3. The pad layout is for reference purposes only.

DISCLAIMER

IMPORTANT NOTICE, PLEASE READ CAREFULLY

The information in this data sheet is intended to describe the operation and characteristics of our products. JSCJ has the right to make any modification, enhancement, improvement, correction or other changes to any content in this data sheet, including but not limited to specification parameters, circuit design and application information, without prior notice.

Any person who purchases or uses JSCJ products for design shall: 1. Select products suitable for circuit application and design; 2. Design, verify and test the rationality of circuit design; 3. Procedures to ensure that the design complies with relevant laws and regulations and the requirements of such laws and regulations. JSCJ makes no warranty or representation as to the accuracy or completeness of the information contained in this data sheet and assumes no responsibility for the application or use of any of the products described in this data sheet.

Without the written consent of JSCJ, this product shall not be used in occasions requiring high quality or high reliability, including but not limited to the following occasions: medical equipment, automotive electronics, military facilities and aerospace. JSCJ shall not be responsible for casualties or property losses caused by abnormal use or application of this product.

Official Website: www.jscj-elec.com

Copyright © JIANGSU CHANGJING ELECTRONICS TECHNOLOGY CO., LTD.