

groov 5–60 VDC Output Modules

Features

- > 12 channels per module
- > Module cover with LED indicates module status
- > Touch-sensitive pad identifies module on *groov* EPIC® processor
- > Channel-specific LEDs simplify troubleshooting
- > Operating temperature: -20 to 70 °C
- > UL Hazardous Locations approved and ATEX compliant
- > Guaranteed for life

DESCRIPTION

groov I/O modules are part of the *groov* EPIC® (Edge Programmable Industrial Controller) system. Wired directly to field devices (sensors and actuators), *groov* I/O translates the electrical signals from those devices into the digital language computers understand—so you can monitor and control devices and use their data wherever you need it, in your local computer network or in cloud services.

These *groov* DC output modules provide 12 isolated channels of 5–60 VDC output, each switching a separate DC load. The module features channel-specific LEDs for troubleshooting.

Choose the module you need based on your requirements:

- The **GRV-ODCI-12** includes a full set of features.
- The **GRV-ODCIS-12** switches output on or off only, offering a lower cost option for projects with simple requirements.

See “Features and Specifications” on page 3 for additional differences.

Wiring is simplified with a top-mounted connector, which provides spring-clamp terminals for power, common, and field wiring. The connector is held in place by a single, captive retention screw but can be removed with the field wiring intact for easier field replacement or wiring in advance.

A pivoting, two-position cover protects wiring from inadvertent contact, as does the dead-front design. The two positions of the cover offer the option of more space to accommodate larger wire. The module cover provides a touch-sensitive pad; touch the pad and the *groov* EPIC processor displays information about the module, including specifications and a wiring diagram.



GRV-ODCI-12 Output Module

A unidirectional, rocking installation process and one captive retention screw firmly secure each module to the chassis, making the unit suitable for locations with environmental vibration.

groov I/O modules are hot swappable and can be installed or removed without turning off the unit or stopping the process.

Each *groov* I/O module cover provides a large module LED to indicate module health at a glance. Discrete modules also include channel-specific LEDs that display the on/off status of each channel.

All *groov* power supplies, voltage converters, adapters, modules, and processors are UL Hazardous Locations approved and compliant with the ATEX, Low Voltage, and EMC CE directives. Each module is factory tested twice before shipment and is guaranteed for life.



Part Numbers

Part	Description
GRV-ODCI-12	DC output, 12 channels, 5–60 VDC, channel-to-channel isolation
GRV-ODCIS-12	DC output, 12 channels, 5–60 VDC, channel-to-channel isolation, on/off only

Preliminary

MOUNTING

Mount *groov* I/O modules on a *groov* EPIC chassis. See chassis data sheet (form 2247).

Installing a Module

1. Place the *groov* EPIC chassis so that the module connector numbers are right-side up, with module location zero on the left, as shown in the diagram below.
2. Hold the module at a 45° angle, aligning the tab on the back tip of the module with the slot at the back of the chassis.
3. Swing the front of the module down to the module connector. Push to snap the module into the connector.
4. Swing the cover up so you can access the retention screw. Secure the module into position by tightening the retention screw.
5. Follow the wiring instructions on [page 4](#) to wire channels to field devices.
6. When wiring is complete, swing the module cover back down to cover the wires. If the wires are too thick to close the cover easily, lift the module cover, then raise the back of the cover up to the higher position. Swing the module cover back down to cover the wires.

CAUTION: Do not overtighten. See the torque specs in the Specifications table.

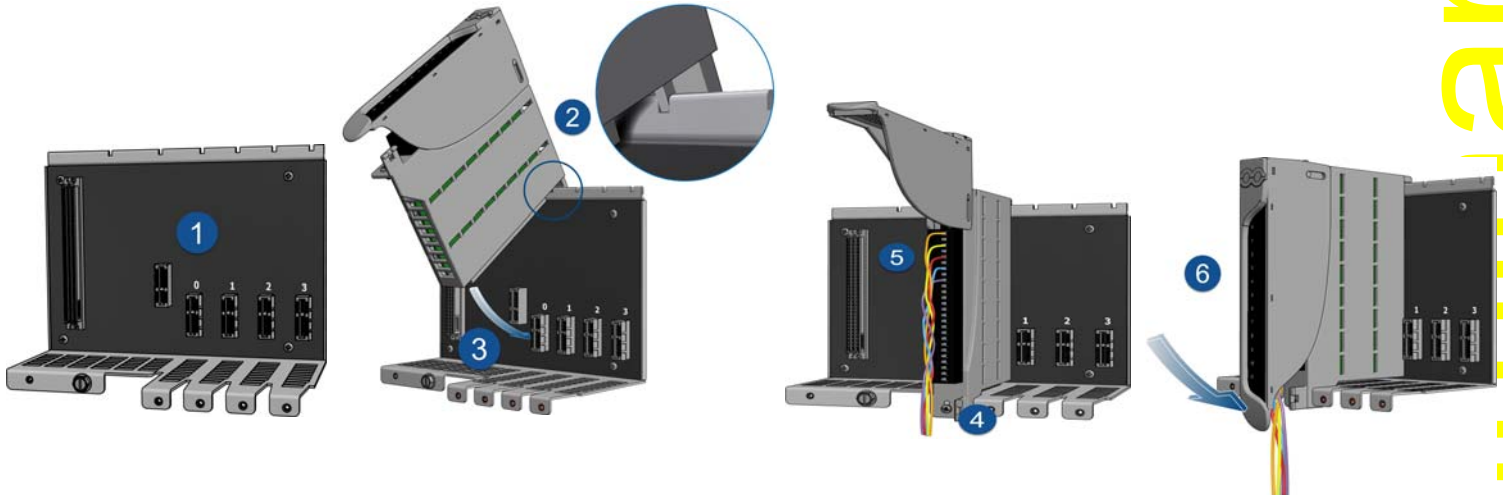

Removing a Module

1. Swing the module cover up so you can access the field wiring and retention screw.
2. Remove field wiring, if desired:
 - To remove the field wiring connector and leave field wiring intact, loosen the connector's captive screw and pull the connector out of the module.
 - To remove individual wires, push the provided screwdriver into the clamp release hole to release the catch, and then pull the wire out.
3. Remove the hold-down screw at the front of the module.
4. Pull up on the front of the module to release it from the module connector, and then swing it back or up to take it out of the slot at the back of the chassis.

Preliminary

FEATURES AND SPECIFICATIONS

Features

Feature	GRV-ODCI-12	GRV-ODCIS-12
Number of channels	12	12
Channel-to-channel isolation	x	x
On/off state	x	x
On/off totalization	x	
Output pulsing	x	

Specifications

Specification	GRV-ODCI-12	GRV-ODCIS-12
Line Voltage Range (nominal)	5–48 VDC	5–48 VDC
Line Voltage Range (max)	5–60 VDC	5–60 VDC
Current Rating	400 mA per channel or 4.8 A per module (70 °C)	400 mA per channel or 4.8 A per module (70 °C)
Surge Current	5 A peak for 1 second	5 A peak for 1 second
Minimum Load	20 mA	20 mA
Output Voltage Drop	1.2 V max.	1.2 V max.
Off-State Leakage	1 mA at 60 V	1 mA at 60 V
Peak Blocking Voltage	60 V	60 V
Problem Indication	N/A	N/A
Isolation (field logic)	300 V working, 1500 V transient (1 minute)	300 V working, 1500 V transient (1 minute)
Isolation (channel-to-channel)	300 V working, 1500 V transient (1 minute)	300 V working, 1500 V transient (1 minute)
Number of Channels	12	12
Chassis Power Consumption	1.2 W	1.2 W
Connector	28–14 AWG	28–14 AWG
Torque, field wiring connector screw	2.5 in-lb (0.28 N-m)	2.5 in-lb (0.28 N-m)
Torque, hold-down screw	3.5 in-lb (0.4 N-m)	3.5 in-lb (0.4 N-m)
Temperature (operating)	-20 °C to +70 °C	-20 °C to +70 °C
Temperature (storage)	-40 °C to +85 °C	-40 °C to +85 °C
Relative Humidity (non-condensing)	5–95%	5–95%
Agency Approvals	UL/cUL (Class 1 Div. 2); CE, ATEX (Category 3, Zone 2), RoHS; DFARS	UL/cUL (Class 1 Div. 2); CE, ATEX (Category 3, Zone 2), RoHS; DFARS
Warranty	Lifetime	Lifetime

PINOUTS AND WIRING

Before you begin wiring, do the following tasks:

- Select the appropriate wire: 28–14 AWG wire rated at 10 A, 300 V. If you're using stranded wire, tin the strands for an easier, better connection.
- Ensure that you have the screwdriver supplied with your module or chassis.
- It may be easier to insert wires if you remove the connector from the module. To remove the connector, loosen the captive hold-down screw at one end of the connector, then pull the connector up to remove it from the module.
- If you have never used a spring-clamp wiring system, take a moment to familiarize yourself with the diagram below. The clamp release hole is where you will insert the screwdriver. The field wiring hole is where you will insert your field wires.

If you look into the field wiring hole, you will see a highly reflective surface. If you can see that surface, that means that the clamp is closed.

Gently push the screwdriver in a little more, until you feel the screwdriver stop.

Note: If you push in too hard, the screwdriver might pop out of the clamp release hole and you'll have to return to step 2.

- Look into the field wiring hole. If it is dark, the clamp is open. You can go to the next step.
 - If you can still see the highly reflective surface, gently pull the screwdriver handle to the left until you feel the blade stop. Hold the screwdriver in that position. Look into the field wiring hole. If it is dark, the clamp is open. You can go to the next step.
4. Insert the wire into the field wiring hole until it meets complete resistance. Then pull out the screwdriver.
 5. Test that the wire is secure by gently pulling on it. If the wire pulls out, repeat steps 2 through 4.

To remove a wire, push the screwdriver into the clamp release hole as described in steps 2 and 3 above, and then pull the wire out.

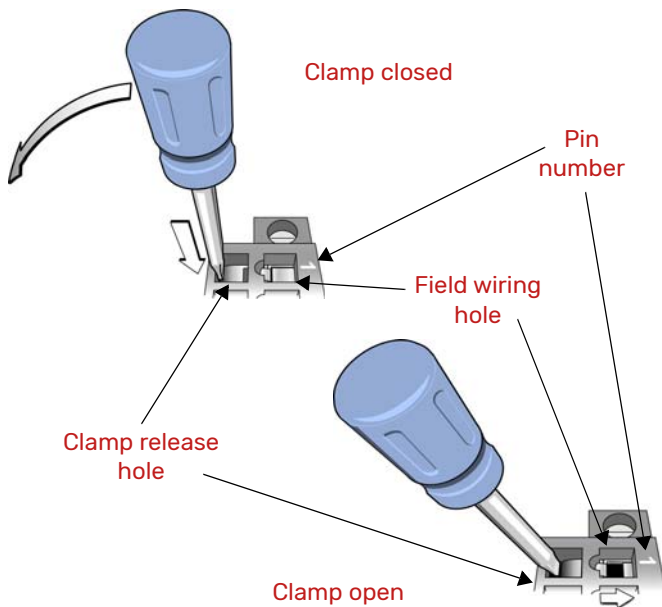











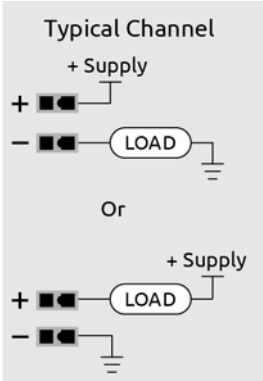















Follow these instructions to connect your field wires to the module:

1. Orient the module or connector to match the wiring diagrams on the following page. If possible, secure the module or the connector with a clamp or on the chassis so that your hands are free to handle the screwdriver and field wires.
2. Hold the screwdriver so that you can place the flat side of the blade against the left side of the clamp release hole.
3. Slide the screwdriver into the clamp release hole, along the left side, until you feel the blade begin to meet some resistance.

Preliminary

WIRING: GRV-ODCI-12, GRV-ODCIS-12

Preliminary

Internal	Pin	External Wiring
Channels internally isolated		
Channel 0	1  +	<div style="border: 1px solid gray; padding: 5px;"> <p>Typical Channel</p>  </div>
	2  -	
Channel 1	3  +	
	4  -	
Channel 2	5  +	
	6  -	
Channel 3	7  +	
	8  -	
Channel 4	9  +	
	10  -	
Channel 5	11  +	
	12  -	
	13  Unused	
	14  Unused	
Channel 6	15  +	
	16  -	
Channel 7	17  +	
	18  -	
Channel 8	19  +	
	20  -	
Channel 9	21  +	
	22  -	
Channel 10	23  +	
	24  -	
Channel 11	25  +	
	26  -	

DIMENSIONS: GRV-ODCI-12, GRV-ODCIS-12

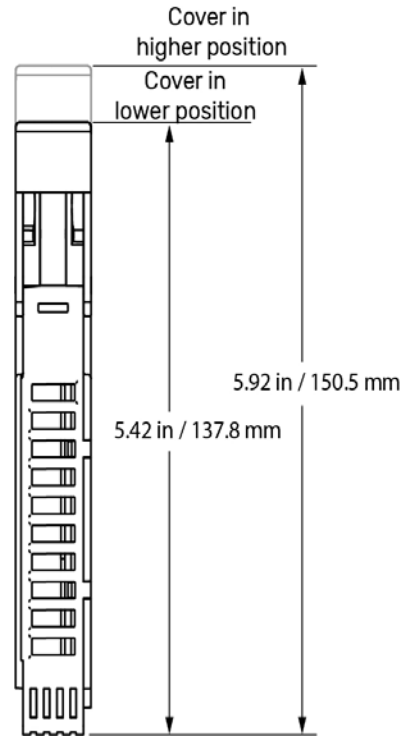
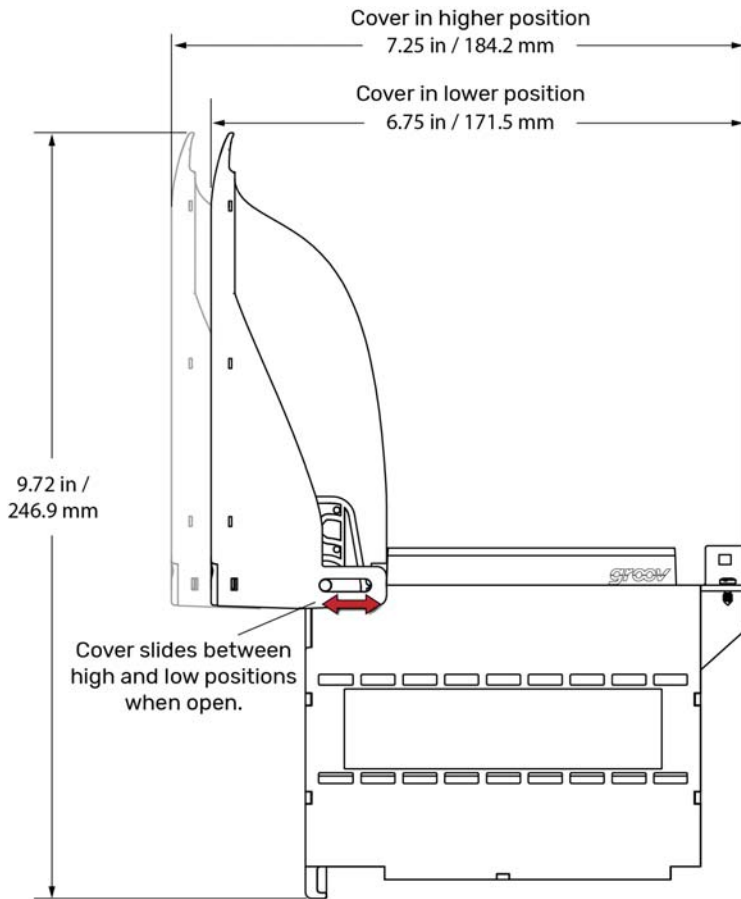

The module cover pivots and can be adjusted to two different heights (positions). The higher position provides more space to accommodate thicker wires.

To switch between higher and lower position, open the cover to at least a 45° angle. Grasp the module cover and do one of the following:

- Pull up on the back hinge to move it to the higher position.
- Push down on the back hinge to move it to the lower position.

You cannot switch the position with the cover closed.

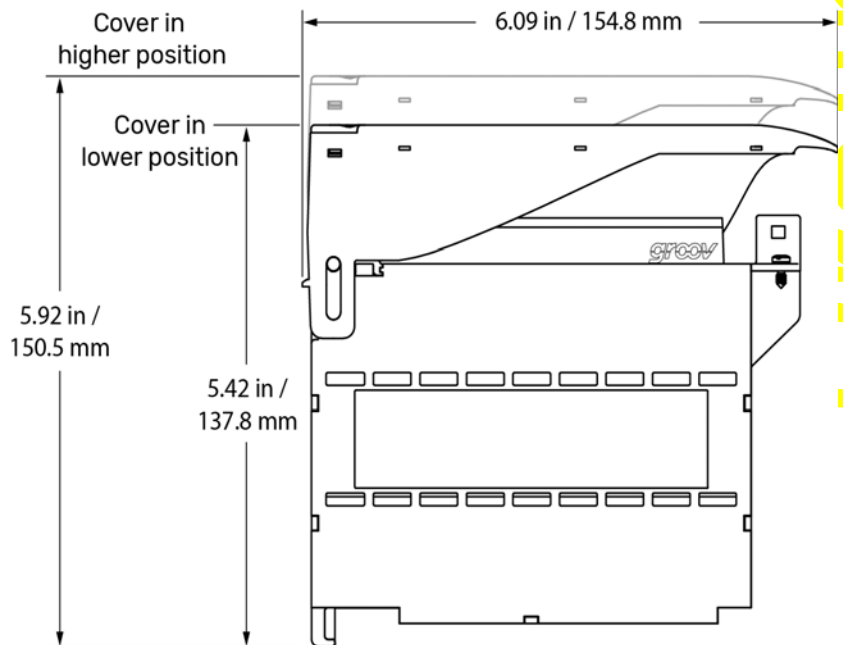

Preliminary

Preliminary

