



ECS-MPI4040

High Current, High Frequency, Miniature Power Inductors



Automotive Applications:

- Driver assistance
- Information
- Entertainment
- Lighting

Applications:

- Handheld/mobile devices
- Portable media players
- GPS/PDAs
- Battery operated devices
- Notebook/netbook
- Tablets/smartbooks
- LCD Displays
- LED Drivers
- POL Converters

Product description:

- AEC-Q200 Qualified, Grade 1
- Handles high transient inrush current spikes
- Magnetically shielded
- Frequency range 20kHz to 10MHz
- Inductance range from 0.09 μ H to 22 μ H
- Current range from 1.1A to 32.0A
- 4.7 x 4.31 footprint surface mount package in 1.2, 1.5, 1.85 or 2.0mm heights
- Rugged construction
- Halogen free, lead free, RoHS compliant

Environmental data:

- Storage temperature range (component): -55°C to +165°C
- Operating temperature range: -55°C to +125°C
- Solder reflow temperature: J-STD-020D compliant



Product specifications

Part Number ⁵	OCL ¹ ± 20% (µH)	Part Marking Designator	I _{rms} ² (Amps)	I _{sat} ³ @ 25°C (Amps)	DCR (mΩ) ± 20% @	K-factor ⁴
R1 -- 1.2mm Height						
ECS-MPI4040R1-R10-R	0.09	A	8.00	32.0 [†]	8.50	1401
ECS-MPI4040R1-R15-R	0.15	B	7.00	26.0 [†]	11.0	989
ECS-MPI4040R1-R22-R	0.23	C	5.50	21.0	18.0	814
ECS-MPI4040R1-R33-R	0.33	D	4.40	17.0	28.0	659
ECS-MPI4040R1-R47-R	0.47	E	5.20	11.5	20.0	1295
ECS-MPI4040R1-R68-R	0.68	F	3.30	9.00	51.0	461
ECS-MPI4040R1-1R0-R	1.0	G	3.70	7.70	40.0	990
ECS-MPI4040R1-1R5-R	1.5	H	3.00	6.50	60.0	732
ECS-MPI4040R1-2R2-R	2.2	I	2.60	5.90	80.0	623
ECS-MPI4040R1-3R3-R	3.3	J	2.20	5.10	115	481
ECS-MPI4040R1-4R7-R	4.7	K	1.80	3.80	180	411
ECS-MPI4040R1-6R8-R	6.8 ^{††}	L	1.50	3.20	250	344
ECS-MPI4040R1-100-R	10 ^{††}	M	1.20	2.80	370	276
R2 -- 1.5mm Height						
ECS-MPI4040R2-R47-R	0.47	A	6.40	12.2	13.0	1403
ECS-MPI4040R2-1R0-R	1.0	B	4.60	8.90	25.0	935
ECS-MPI4040R2-1R5-R	1.5	C	3.80	7.60	37.0	701
ECS-MPI4040R2-2R2-R	2.2	D	3.20	5.70	58.0	647
ECS-MPI4040R2-3R3-R	3.3	E	2.60	5.40	76.0	495
ECS-MPI4040R2-4R7-R	4.7	F	2.20	4.30	105	421
ECS-MPI4040R2-6R8-R	6.8	G	1.80	3.40	158	351
ECS-MPI4040R2-100-R	10.0 ^{††}	H	1.50	3.10	240	271

1 Open Circuit Inductance (OCL) Test Parameters: 100kHz, 0.10V_{rms}, 0.0A_{dc}

2 I_{rms}: DC current for an approximate temperature rise of 40°C without core loss. De-rating is necessary for AC currents. Temperature rise is dependent upon several factors, including the PCB pad layout, trace thickness and width, air-flow and proximity to other heat generating components. It is recommended the part temperature not exceed 125°C under worst case operating conditions and therefore, the temperature rise should be verified in the end use application. Irms testing was performed on a 19.05mm long x 6.35mm wide x 0.070mm thick copper trace in still air.

3 I_{sat}: Peak current for approximately 30% rolloff at +25°C.

4 K-factor: Used to determine B_{p-p} for core loss (see graph). B_{p-p} = K * L * DI.
Bp-p : (Gauss), K: (K-factor from table), L: (inductance in µH),
DI (peak-to-peak ripple current in amps).

5 Part Number Definition: ECS-MPI4040RX-XXX-R

- ECS-MPI4040X = product code and size
- XXX = inductance value in all, "R" = decimal point
- If no "R" is present, then third digit equals the number of zeros
- "-R" suffix = RoHS compliant

† Transient pulse not to exceed 1 millisecond.

†† Maximum operating frequency less than 10MHz, consult factory for application specific values.

Part Number ⁵	OCL ¹ ± 20% (µH)	Part Marking Designator	I _{rms} ² (Amps)	I _{sat} ³ @ 25°C (Amps)	DCR (mΩ) ± 20% @ 20°C	K-factor ⁴
R3 -- 1.85mm Height						
ECS-MPI4040R3-R22-R	0.22	A	8.00	20.0	5.8	1870
ECS-MPI4040R3-R47-R	0.47	B	5.80	17.0	10.3	1530
ECS-MPI4040R3-1R2-R	1.2	C	4.00	9.40	32.0	732
ECS-MPI4040R3-1R5-R	1.5	D	3.80	8.20	36.0	673
ECS-MPI4040R3-2R2-R	2.2	E	3.40	7.90	48.0	543
ECS-MPI4040R3-3R3-R	3.3	F	3.00	6.60	60.0	432
ECS-MPI4040R3-4R7-R	4.7	G	2.30	4.80	92.0	374
ECS-MPI4040R3-6R8-R	6.8	H	2.00	4.50	120	306
ECS-MPI4040R3-100-R	10.0	I	1.50	3.80	213	251
ECS-MPI4040R3-150-R	15.0	J	1.30	3.00	285	213
ECS-MPI4040R3-220-R	22.0††	K	1.10	2.20	408	174
R4 -- 2.0mm Height						
ECS-MPI4040R4-R22-R	0.22	A	10.1	15.0	5.3	2405
ECS-MPI4040R4-R33-R	0.33	B	9.50	12.8	6.0	1870
ECS-MPI4040R4-R47-R	0.45	C	8.10	11.5	8.2	1530
ECS-MPI4040R4-1R0-R	1.0	D	5.70	8.20	17.0	990
ECS-MPI4040R4-1R5-R	1.5	E	4.90	6.90	23.0	802
ECS-MPI4040R4-2R2-R	2.2	F	3.90	5.70	35.0	673
ECS-MPI4040R4-3R3-R	3.3††	G	3.30	4.50	49.0	510
ECS-MPI4040R4-4R7-R	4.7††	H	2.90	3.90	67.0	455
ECS-MPI4040R4-6R8-R	6.8††	I	2.40	3.20	91.0	374
ECS-MPI4040R4-100-R	10.0††	J	1.90	2.60	148	306
ECS-MPI4040R4-220-R	22.0††	K	1.30	1.80	316	203

- 1 Open Circuit Inductance (OCL) Test Parameters: 100kHz, 0.10V_{rms}, 0.0A_{dc}
- 2 I_{rms}: DC current for an approximate temperature rise of 40°C without core loss. De-rating is necessary for AC currents. Temperature rise is dependent upon several factors, including the PCB pad layout, trace thickness and width, air-flow and proximity to other heat generating components. It is recommended the part temperature not exceed 125°C under worst case operating conditions and therefore, the temperature rise should be verified in the end use application. Irms testing was performed on a 19.05mm long x 6.35mm wide x 0.070mm thick copper trace in still air.
- 3 I_{sat}: Peak current for approximately 30% rolloff at +25°C.

- 4 K-factor: Used to determine B_{p-p} for core loss (see graph). B_{p-p} = K * L * DI.
Bp-p : (Gauss), K: (K-factor from table), L: (inductance in µH),
DI (peak-to-peak ripple current in amps).
- 5 Part Number Definition: ECS-MPI4040RX-XXX-R
 - ECS-MPI4040X = product code and size
 - XXX = inductance value in all, "R" = decimal point
 - If no "R" is present, then third digit equals the number of zeros
 - "-R" suffix = RoHS compliant
- † Transient pulse not to exceed 1 millisecond.
- †† Maximum operating frequency less than 10MHz, consult factory for application specific values.

Dimensions – mm

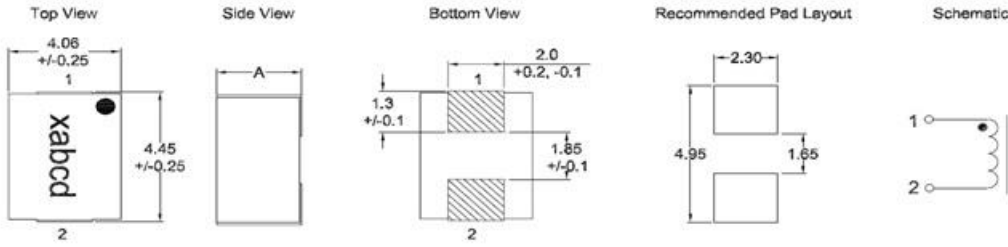

Part #	A Max.
MPI4040R1-xxx-R	1.2
MPI4040R2-xxx-R	1.5
MPI4040R3-xxx-R	1.85
MPI4040R4-xxx-R	2.0

Part Marking: xabc
 x = height: 1=R1 (1.2mm), 2=R2 (1.5 mm), 3=R3 (1.85 mm), 4=R4 (2.0 mm).
 a = Inductance value per the "Part Marking Designator" letter code in product table
 b = Bi-weekly date code
 c = Last digit of year manufactured

Soldering Surface to be coplanar within 0.1018 mm
 PCM tolerance ± 0.1 mm unless otherwise specified

Packaging information - mm

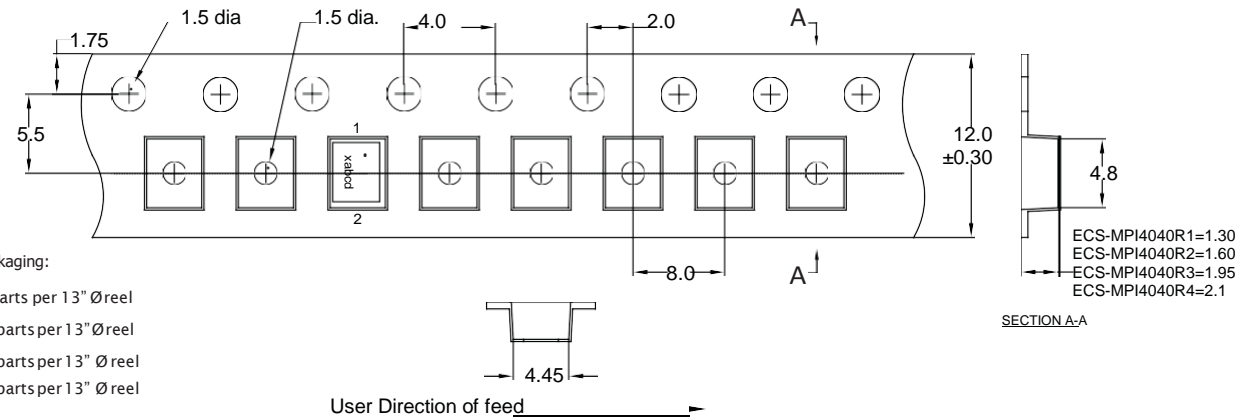

Supplied in tape and reel packaging:

- ECS-MPI4040R1 = 5500 parts per 13" \varnothing reel
- ECS-MPI4040R2 = 4500 parts per 13" \varnothing reel
- ECS-MPI4040R3 = 3500 parts per 13" \varnothing reel
- ECS-MPI4040R4 = 3000 parts per 13" \varnothing reel

Temperature rise vs. total loss

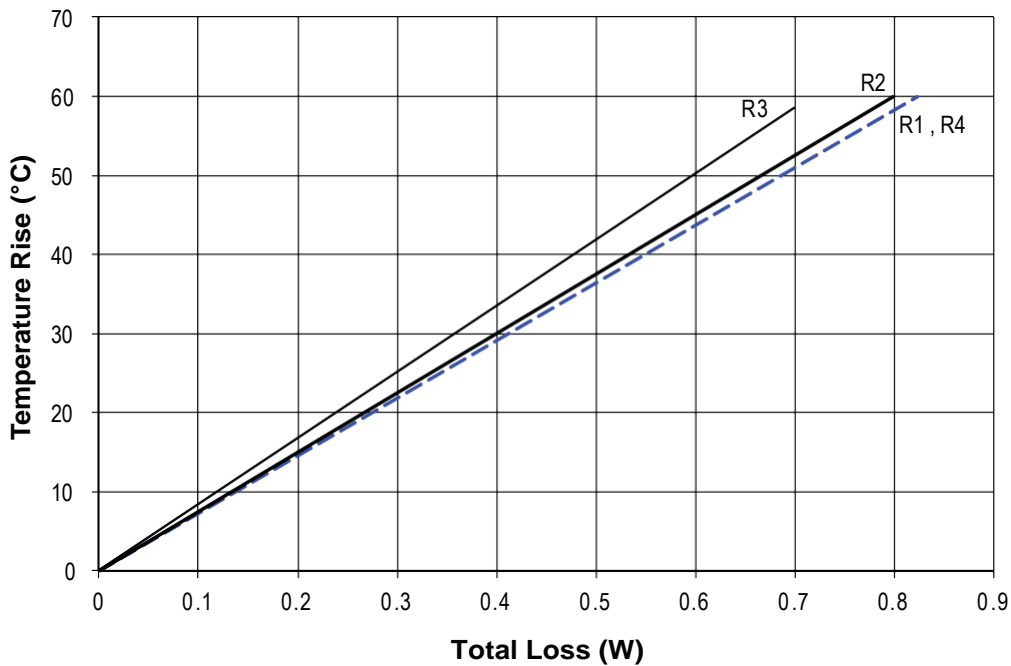

Core loss

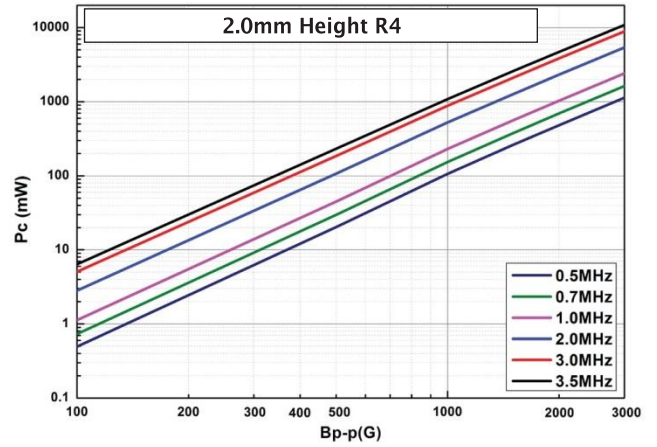
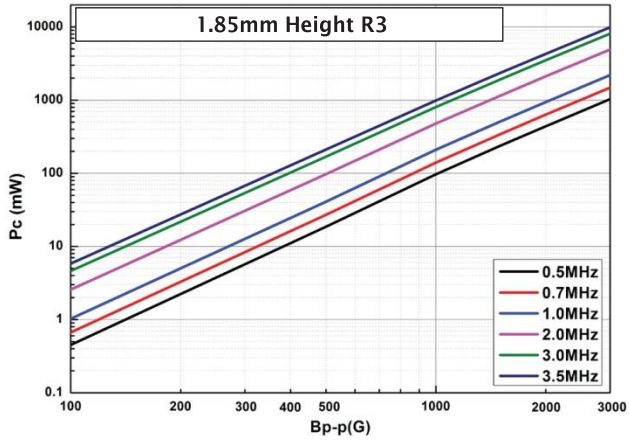
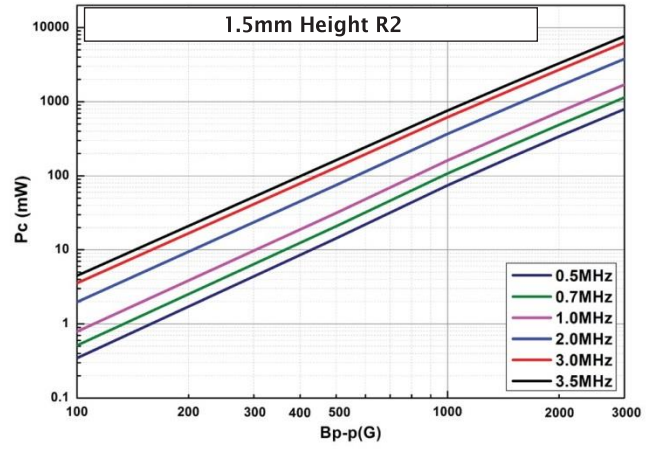
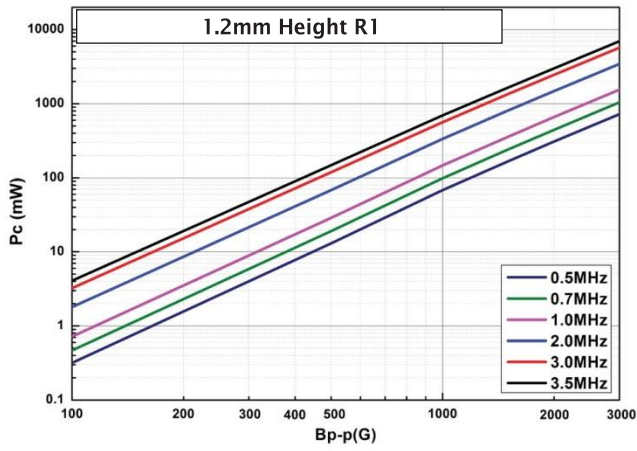

1.2mm Height R1 inductance characteristics — % of OCL vs. I_{DC}

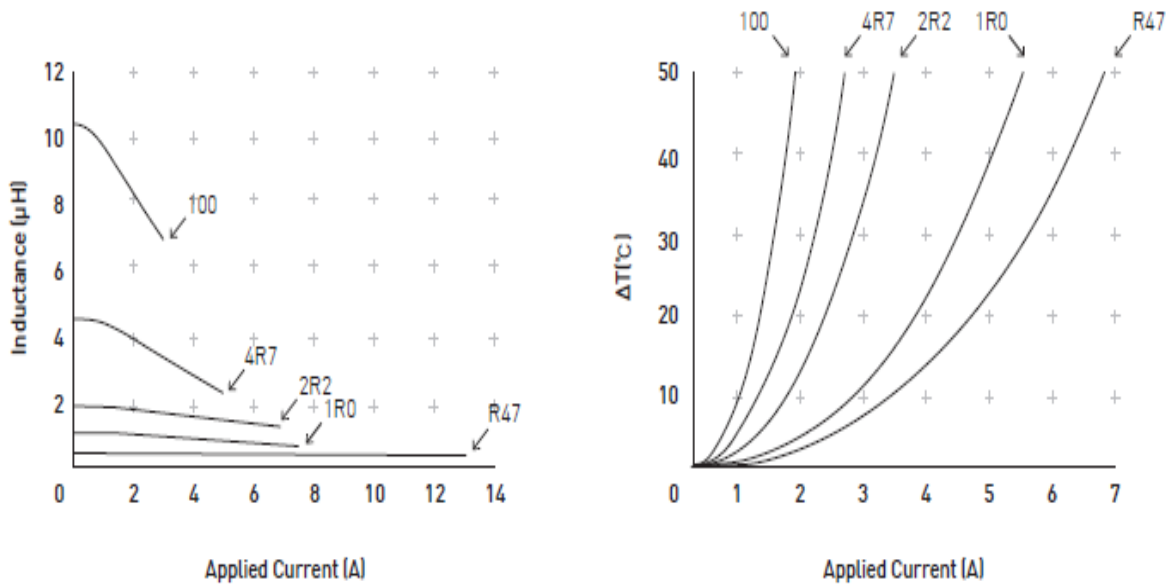

1.5mm Height R2 inductance characteristics — % of OCL vs. I_{DC}

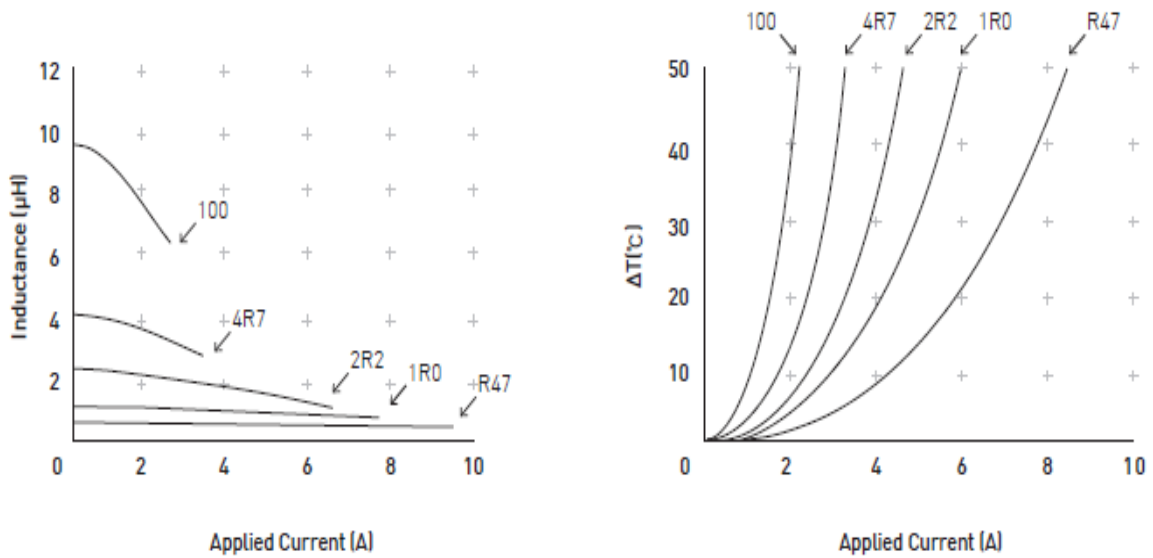

1.85mm Height R3 inductance characteristics — % of OCL vs. I_{DC}

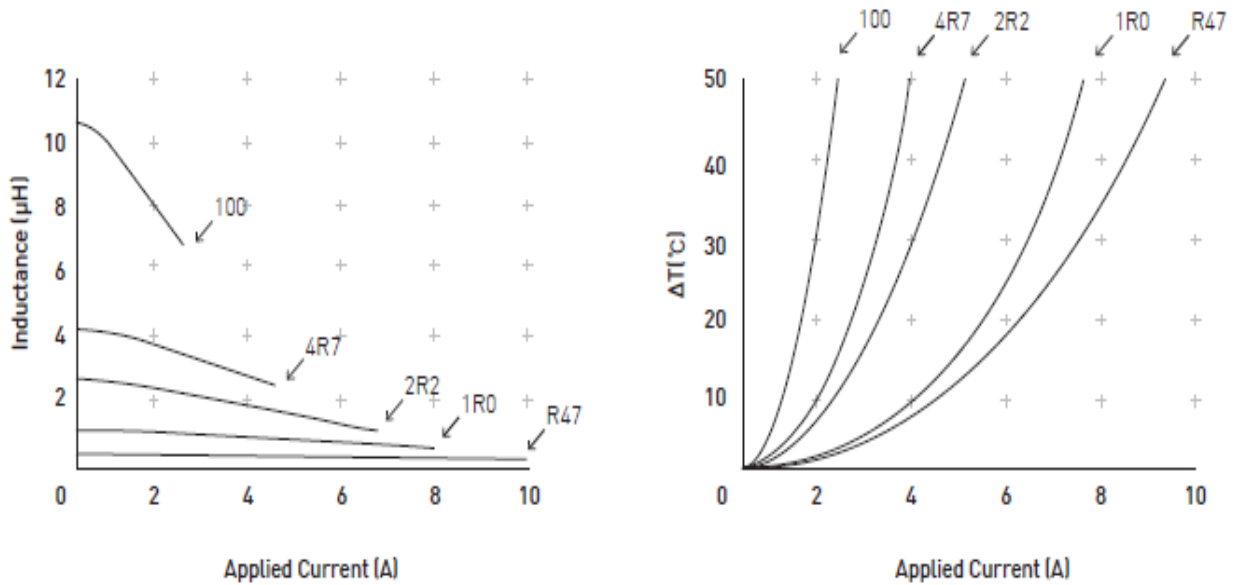

2.0mm Height R4 inductance characteristics — % of OCL vs. I_{DC}

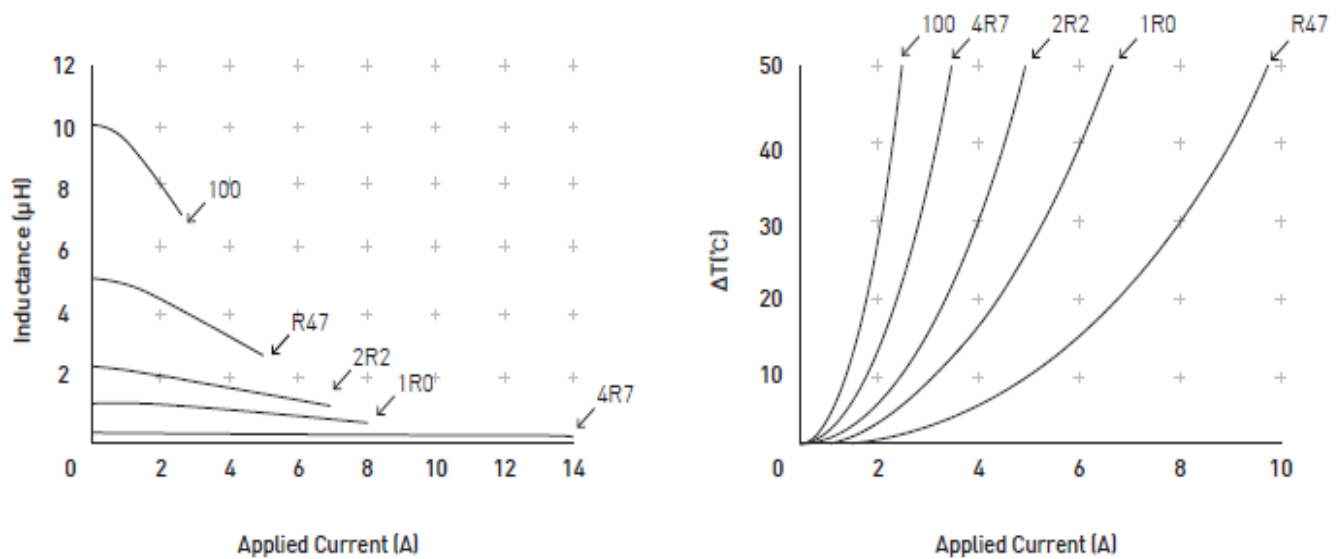

Solder reflow profile

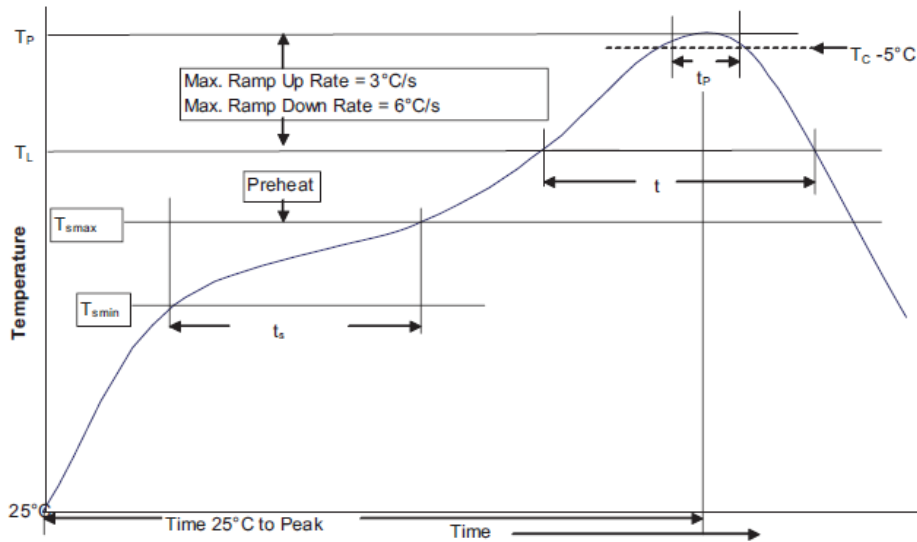

Table 1 - Standard SnPb Solder (T_c)

Package Thickness	Volume mm^3 <350	Volume mm^3 ≥ 350
<2.5mm	235°C	220°C
$\geq 2.5\text{mm}$	220°C	220°C

Table 2 - Lead (Pb) Free Solder (T_c)

Package Thickness	Volume mm^3 <350	Volume mm^3 350 - 2000	Volume mm^3 >2000
<1.6mm	260°C	260°C	260°C
1.6 - 2.5mm	260°C	250°C	245°C
>2.5mm	250°C	245°C	245°C

Reference JDEC J-STD-020D

Profile Feature	Standard SnPb Solder	Lead (Pb) Free Solder
Preheat and Soak	· Temperature min. (T_{smin})	150°C
	· Temperature max. (T_{smax})	200°C
	· Time (T_{smin} to T_{smax}) (t_s)	60-120 Seconds
Average ramp up rate T_{smax} to T_p	3°C/ Second Max.	3°C/ Second Max.
Liquidous temperature (T_L)	183°C	217°C
Time at liquidous (t_L)	60-150 Seconds	60-150 Seconds
Peak package body temperature (T_p)*	Table 1	Table 2
Time (t_p)** within 5 °C of the specified classification temperature (T_c)	20 Seconds**	30 Seconds**
Average ramp-down rate (T_p to T_{smax})	6°C/ Second Max.	6°C/ Second Max.
Time 25°C to Peak Temperature	6 Minutes Max.	8 Minutes Max.

* Tolerance for peak profile temperature (T_p) is defined as a supplier minimum and a user maximum.

** Tolerance for time at peak profile temperature (t_p) is defined as a supplier minimum and a user maximum.