

21 Series Photo-MOSFET Relay

- **Features:** Low Capacitance Photo MOSFET Relay, switching up to 40V DC or Peak AC
- **SOP;** Low Off-State Leakage Current; Low Output Capacitance; UL listed
- **Applications:** Automatic Test Equipment, I/O Modules, Telephone Equipment
- **Markets:** Telecommunication, Test & Measurement, Security

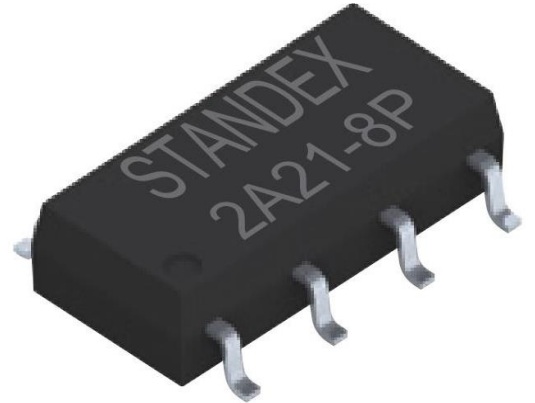

Part Description: **SMP-XA21-XPX-X**

Number of Poles	Contact Form	Series Number	Number of Pins	Mounting Type	Package Style	Special Features
1, 2	A	21	4, 8	P	Tube, Reel	Nil

See page 5 for Glossary

Maximum Ratings @ Ambient Temperature = 25°C

Parameters	Symbol	Value		Units	Condition
		1A21-4P	1A21-8P		
INPUT SPECIFICATIONS					
Continuous LED Current	I_F	50	50	mA	-
Peak LED Current	I_{FP}	500	5	mA	f=100Hz, 1% Duty Cycle
LED Reverse Voltage	V_R	5	500	V	-
Input Power Dissipation	P_{IN}	75	75	mW	-
OUTPUT SPECIFICATIONS					
Load Voltage	V_L	40	40	DC or Peak AC	-
Load Current	I_L	250	250	mA	-
Peak Load Current	I_{PEAK}	750	750	mA	1 ms, 1 shot
Output Power Dissipation	P_{OUT}	300	400	mW	-
GENERAL SPECIFICATIONS					
Total Power Dissipation	P_T	350	450	mW	-
I/O Breakdown Voltage	$V_{I/O}$	1500	1500	V_{RMS}	-
Operating Temperature	T_{OPR}	-40/+85	-40/+85	°C	-
Storage Temperature	T_{STG}	-40/+100	-40/+100	°C	-



RoHS

REACH
COMPLIANT

21 Series Photo-MOSFET Relay

Maximum Ratings @ Ambient Temperature = 25°C

Parameters	Symbol	Min	Typ	Max	Units	Condition
INPUT SPECIFICATIONS						
LED Forward Voltage	V_F	1.0	1.17	1.5	V	$I_F = 10\text{mA}$
Operation LED Current	$I_{F\text{ ON}}$	-	0.3	3.0	mA	-
Recovery LED Voltage	$V_{F\text{ OFF}}$	0.5	1.0	-	V	-
OUTPUT SPECIFICATIONS						
On Resistance: Drain to Drain	R_{ON}	-	0.9	1.2	Ω	$I_F = 5\text{mA}, I_L = \text{Rating (within 1 sec.)}$
Off-State Leakage Current	I_{LEAK}	-	0.03	10	nA	$V_L = 40\text{V}$
Output Capacitance	C_{OUT}	-	13	-	ρF	$V_L = 0\text{V}, f = 1\text{MHz}$
TRANSMISSION SPECIFICATIONS						
Turn-On Time	T_{ON}	-	0.07	5.0	ms	$I_F = 5\text{mA}, I_L = \text{Rating}$
Turn-Off Time	T_{OFF}	-	0.06	0.2	ms	
COUPLED SPECIFICATIONS						
I/O Insulation Resistance	$R_{\text{I/O}}$	10^9	-	-	Ω	-
I/O Capacitance	$C_{\text{I/O}}$	-	0.8	-	ρF	$f = 1\text{MHz}$

Photo-MOSFET Relay Dimensions (Tolerances acc. to ISO 2768-mp)

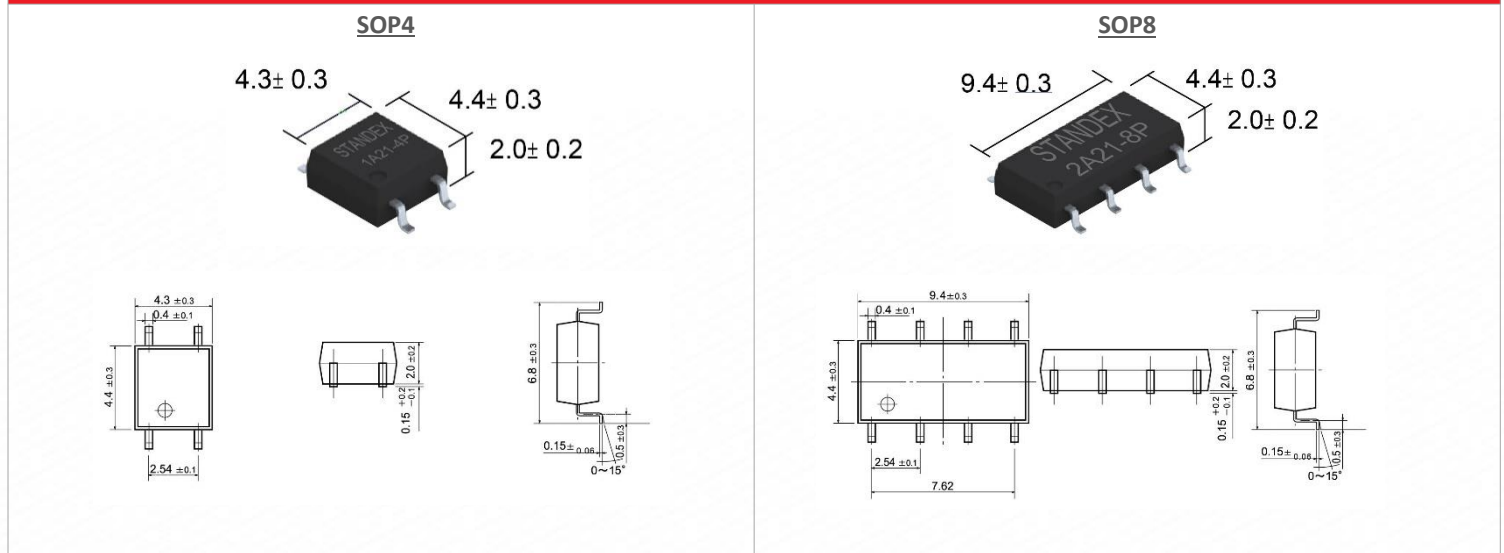

21 Series Photo-MOSFET Relay

Photo-MOSFET Relay Pin-Out

4-PIN

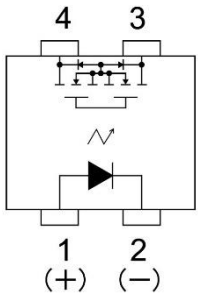

- 1: Anode (LED)
- 2: Cathode (LED)
- 3,4: Drain (MOS FET)

8-PIN

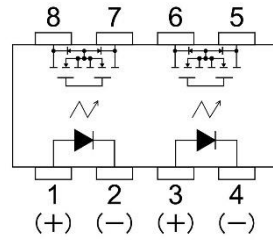

- 1,3: Anode (LED)
- 2,4: Cathode (LED)
- 5,6,7,8: Drain (MOS FET)

Photo MOSFET Relay Recommended PCB Pad Layout (Tolerances acc. to ISO 2768-mp)

SOP4 (Top View)

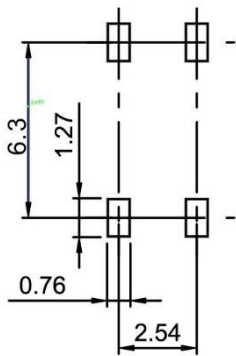

SOP8 (Top View)

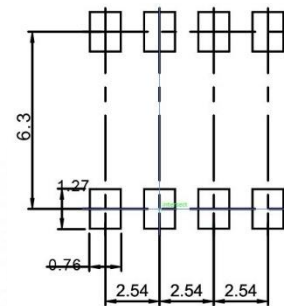

21 Series Photo-MOSFET Relay

Photo MOSFET Relay Reference Data

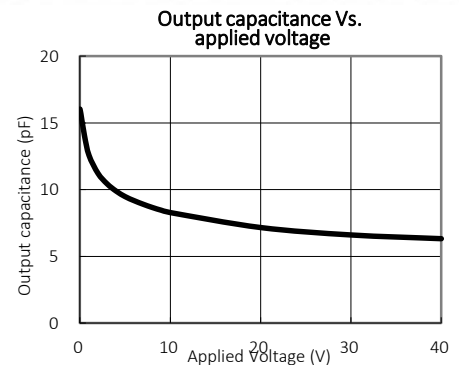
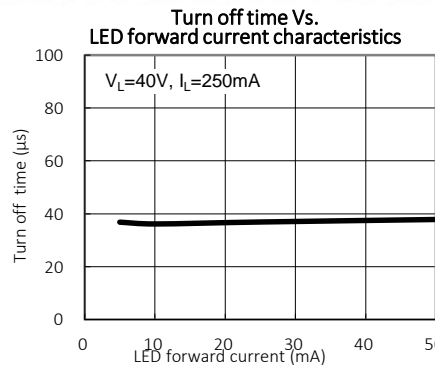
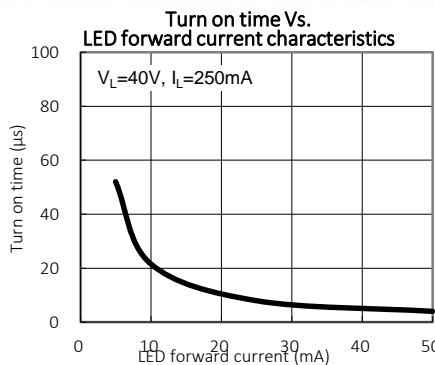
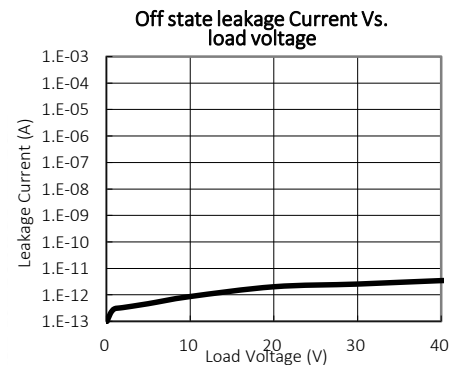
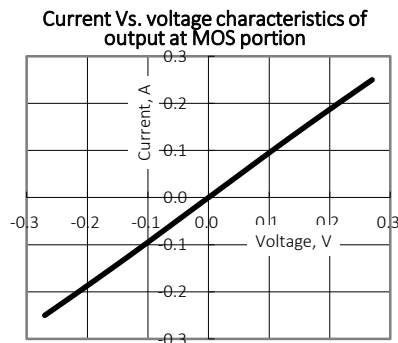
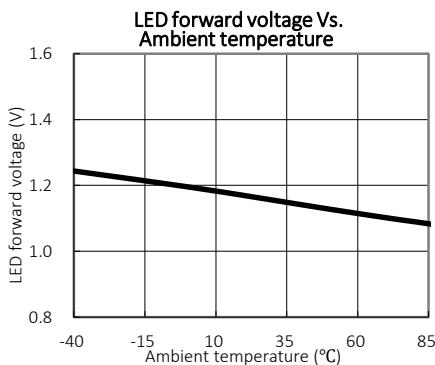
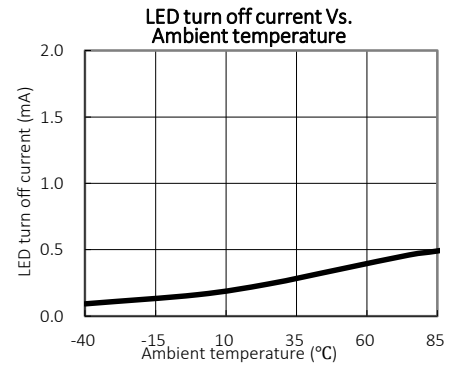
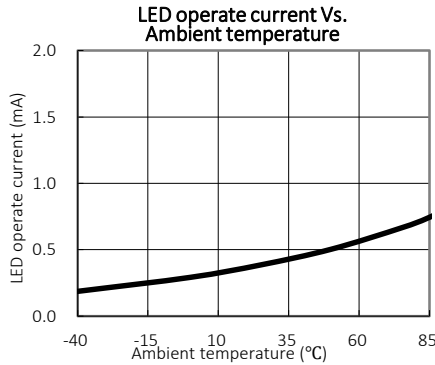
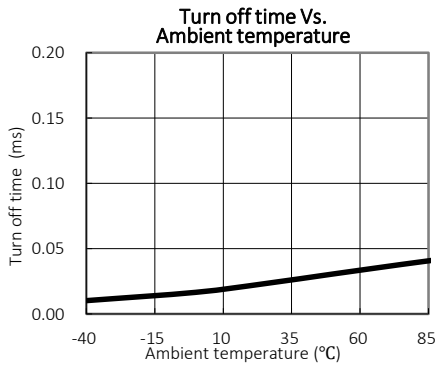
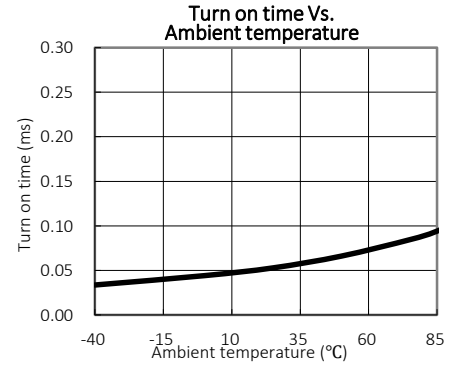
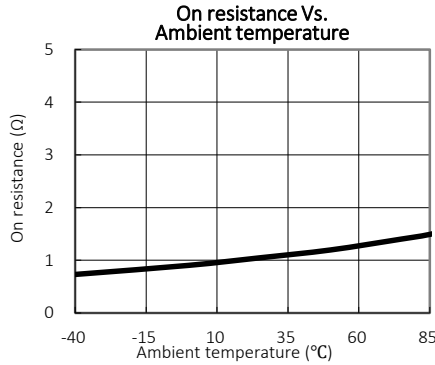
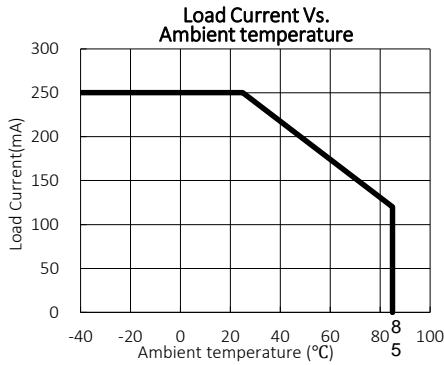

21 Series Photo-MOSFET Relay

Photo MOSFET Relay Tape & Reel Packaging (1,000 pcs per reel)

SOP4

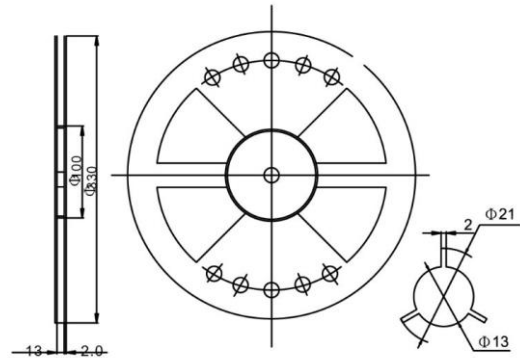
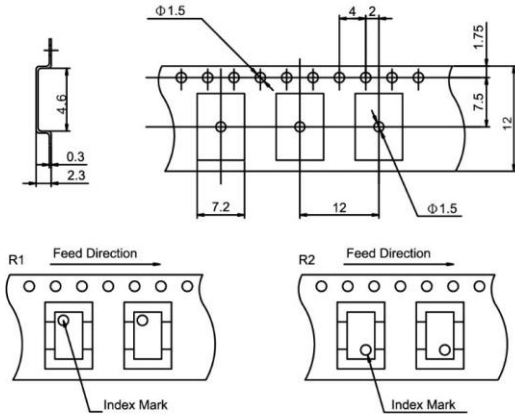

SOP8

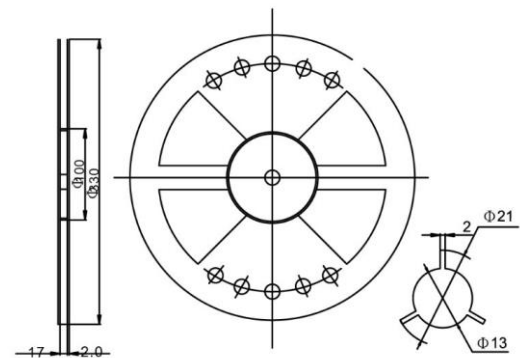
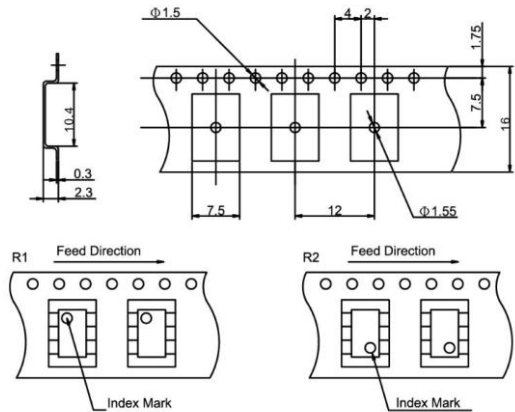

Glossary Options

D	DIP (Dual-In-Line Package)
S	SMD (Surface Mount Design)
P	SOP (Small-Outline Package)
Q	AEC-Q101 / High Temperature
R	Reinforced Isolation

Please note: All technical specifications in this series datasheet refer to the standard product range. Modifications in the sense of technical progress are reserved. For general information only. For more specific information, please consult the product datasheet, available upon request.

This series datasheet could contain technical inaccuracies or typographical errors. Changes are periodically made to the information herein. These changes will be incorporated in future revisions.

For deviating values, latest specifications and product details, please contact your nearest sales office.