

# 1, 2 and 4-Channel Low Capacitance ESD Protection Arrays

## CM1213A, SZCM1213A

### Product Description

The CM1213A family of diode arrays has been designed to provide ESD protection for electronic components or subsystems requiring minimal capacitive loading. These devices are ideal for protecting systems with high data and clock rates or for circuits requiring low capacitive loading. Each ESD channel consists of a pair of diodes in series which steer the positive or negative ESD current pulse to either the positive ( $V_P$ ) or negative ( $V_N$ ) supply rail. A Zener diode is embedded between  $V_P$  and  $V_N$ , offering two advantages. First, it protects the  $V_{CC}$  rail against ESD strikes, and second, it eliminates the need for a bypass capacitor that would otherwise be needed for absorbing positive ESD strikes to ground. The CM1213A will protect against ESD pulses up to 12 kV per the IEC 61000-4-2 standard.

### Features

- One, Two, and Four Channels of ESD Protection  
Note: For 6 and 8-channel Devices, See the CM1213 Data Sheet
- Provides ESD Protection to IEC61000-4-2 Level 4
  - ◆  $\pm 12$  kV Contact Discharge
- Low Channel Input Capacitance of 0.85 pF Typical
- Minimal Capacitance Change with Temperature and Voltage
- Channel Input Capacitance Matching of 0.02 pF Typical is Ideal for Differential Signals
- Each CH (I/O) Pin Can Withstand Over 1000 ESD Strikes\*
- SZ Prefix for Automotive and Other Applications Requiring Unique Site and Control Change Requirements; AEC-Q101 Qualified and PPAP Capable
- These Devices are Pb-Free, Halogen Free/BFR Free and are RoHS Compliant

### Applications

- USB2.0 Ports at 480 Mbps in Desktop PCs, Notebooks and Peripherals
- IEEE1394 Firewire® Ports at 400 Mbps/800 Mbps
- DVI Ports, HDMI Ports in Notebooks, Set Top Boxes, Digital TVs, LCD Displays
- Serial ATA Ports in Desktop PCs and Hard Disk Drives
- PCI Express Ports
- General Purpose High-Speed Data Line ESD Protection

\*Standard test condition is IEC61000-4-2 level 4 test circuit with each pin subjected to  $\pm 8$  kV contact discharge for 1000 pulses. Discharges are timed at 1 second intervals and all 1000 strikes are completed in one continuous test run. The part is then subjected to standard production test to verify that all of the tested parameters are within spec after the 1000 strikes.

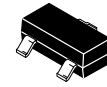

SOT23-3  
SO SUFFIX  
CASE 318

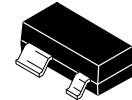

SOT-143  
SR SUFFIX  
CASE 318A



SC-74  
SO SUFFIX  
CASE 318F

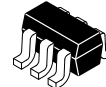

SC70-6  
S7 SUFFIX  
CASE 419AD

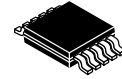

MSOP-10  
MR SUFFIX  
CASE 846AE

### MARKING DIAGRAMS

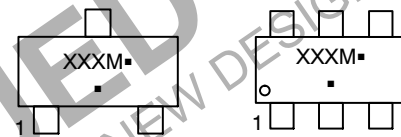

XXX = Specific Device Code  
M = Date Code  
▪ = Pb-Free Package

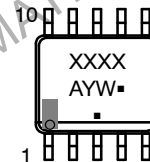

XXXX = Specific Device Code  
A = Assembly Location  
Y = Year  
W = Work Week  
▪ = Pb-Free Package

(Note: Microdot may be in either location)

### ORDERING INFORMATION

See detailed ordering, marking and shipping information on page 2 of this data sheet.

# CM1213A, SZCM1213A

## BLOCK DIAGRAM

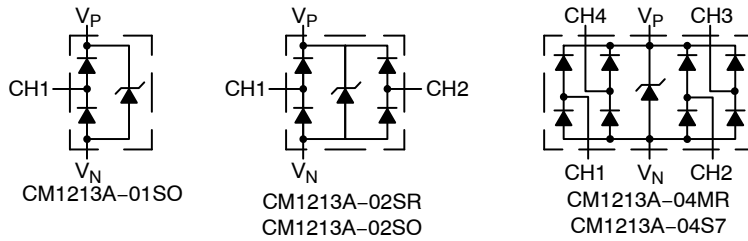

**Table 1. ORDERING INFORMATION**

| Device          | Marking | Package               | Shipping†           |
|-----------------|---------|-----------------------|---------------------|
| CM1213A-01SO    | 231     | SOT23-3<br>(Pb-Free)  | 3,000 / Tape & Reel |
| SZCM1213A-01SO* |         |                       |                     |
| CM1213A-02SR    | D232    | SOT143-4<br>(Pb-Free) | 3,000 / Tape & Reel |
| SZCM1213A-02SR* |         |                       |                     |
| CM1213A-02SO    | 233     | SC-74<br>(Pb-Free)    | 3,000 / Tape & Reel |
| CM1213A-04S7    | D38     | SC70-6<br>(Pb-Free)   | 3,000 / Tape & Reel |
| CM1213A-04MR    | D237    | MSOP-10<br>(Pb-Free)  | 4,000 / Tape & Reel |

†For information on tape and reel specifications, including part orientation and tape sizes, please refer to our Tape and Reel Packaging Specifications Brochure, BRD8011/D.

\*SZ Prefix for Automotive and Other Applications Requiring Unique Site and Control Change Requirements; AEC-Q101 Qualified and PPAP Capable.

DISCONTINUED

THIS DEVICE IS NOT RECOMMENDED FOR NEW DESIGN  
PLEASE CONTACT YOUR ONSEMI REPRESENTATIVE FOR INFORMATION

# CM1213A, SZCM1213A

**Table 2. PIN DESCRIPTIONS**

| 1-Channel, 3-Lead SOT23-3 Package (CM1213A-01SO) |                |      |                              |
|--|----------------|------|------------------------------|
| Pin  | Name           | Type | Description                  |
| 1  | CH1            | I/O  | ESD Channel                  |
| 2  | V <sub>P</sub> | PWR  | Positive Voltage Supply Rail |
| 3  | V <sub>N</sub> | GND  | Negative Voltage Supply Rail |

| 2-Channel, 4-Lead SOT143-4 Package (CM1213A-02SR) |                |      |                              |
|---|----------------|------|------------------------------|
| Pin   | Name           | Type | Description                  |
| 1   | V <sub>N</sub> | GND  | Negative Voltage Supply Rail |
| 2   | CH1            | I/O  | ESD Channel                  |
| 3   | CH2            | I/O  | ESD Channel                  |
| 4   | V <sub>P</sub> | PWR  | Positive Voltage Supply Rail |

| 2-Channel, SC-74 Package (CM1213A-02SO) |                |      |                              |
|---|----------------|------|------------------------------|
| Pin                                     | Name           | Type | Description                  |
| 1                                       | NC             | -    | No Connect                   |
| 2                                       | V <sub>N</sub> | GND  | Negative Voltage Supply Rail |
| 3                                       | CH1            | I/O  | ESD Channel                  |
| 4                                       | CH2            | I/O  | ESD Channel                  |
| 5                                       | NC             | -    | No Connect                   |
| 6                                       | V <sub>P</sub> | PWR  | Positive Voltage Supply Rail |

| 4-Channel, 6-Lead SC70-6 (CM1213A-04S7) |                |      |                              |
|---|----------------|------|------------------------------|
| Pin                                     | Name           | Type | Description                  |
| 1                                       | CH1            | I/O  | ESD Channel                  |
| 2                                       | V <sub>N</sub> | GND  | Negative Voltage Supply Rail |
| 3                                       | CH2            | I/O  | ESD Channel                  |
| 4                                       | CH3            | I/O  | ESD Channel                  |
| 5                                       | V <sub>P</sub> | PWR  | Positive Voltage Supply Rail |
| 6                                       | CH4            | I/O  | ESD Channel                  |

| 4-Channel, 10-Lead MSOP-10 Package (CM1213A04MR) |                |      |                              |
|--|----------------|------|------------------------------|
| Pin  | Name           | Type | Description                  |
| 1  | CH1            | I/O  | ESD Channel                  |
| 2  | NC             | -    | No Connect                   |
| 3  | V <sub>P</sub> | PWR  | Positive Voltage Supply Rail |
| 4  | CH2            | I/O  | ESD Channel                  |
| 5  | NC             | -    | No Connect                   |
| 6  | CH3            | I/O  | ESD Channel                  |
| 7  | NC             | -    | No Connect                   |
| 8  | V <sub>N</sub> | GND  | Negative Voltage Supply Rail |
| 9  | CH4            | I/O  | ESD Channel                  |
| 10   | NC             | -    | No Connect                   |

**PACKAGE/PINOUT DIAGRAMS**

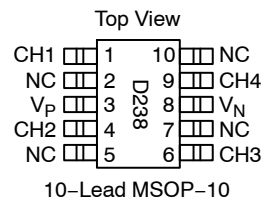
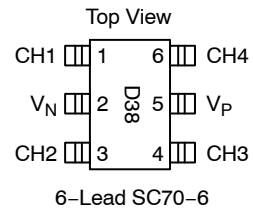
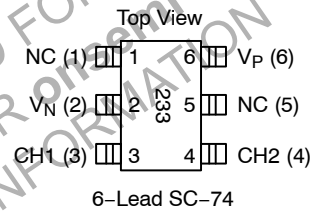
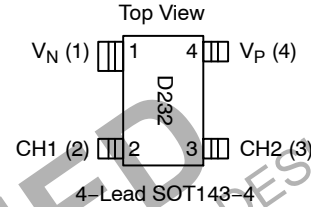
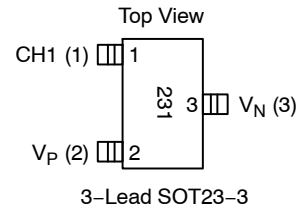

# CM1213A, SZCM1213A

## SPECIFICATIONS

**Table 3. ABSOLUTE MAXIMUM RATINGS**

| Parameter  | Rating  | Units |
|--|---|-------|
| Operating Supply Voltage ( $V_P - V_N$ )   | 5.5   | V     |
| Operating Temperature Range  | -40 to +150   | °C    |
| Storage Temperature Range  | -65 to +150   | °C    |
| DC Voltage at any channel input  | $(V_N - 0.5)$ to $(V_P + 0.5)$                          | V     |
| Package Power Rating<br>SOT23-3, SOT143-4, SC-74, and SC70-6 Packages<br>MSOP-10 Package   | 225<br>400  | mW    |
| ESD<br>IEC 61000-4-2 Contact<br>IEC 61000-4-2 Air<br>ISO 10605 330 pF / 330 $\Omega$ Contact<br>ISO 10605 330 pF / 2 k $\Omega$ Contact<br>ISO 10605 150 pF / 2 k $\Omega$ Contact | $\pm 12$<br>$\pm 12$<br>$\pm 9$<br>$\pm 22$<br>$\pm 25$ | kV    |

Stresses exceeding those listed in the Maximum Ratings table may damage the device. If any of these limits are exceeded, device functionality should not be assumed, damage may occur and reliability may be affected.

**Table 4. ELECTRICAL OPERATING CHARACTERISTICS** (Note1)

| Symbol              | Parameter   | Conditions   | Min          | Typ          | Max          | Units    |
|---------------------|---|--|--------------|--------------|--------------|----------|
| $V_P$ ( $V_{RWM}$ ) | Operating Supply Voltage ( $V_P - V_N$ )                            |  |              | 3.3          | 5.5          | V        |
| $I_P$               | Operating Supply Current  | $V_P$ pin to $V_N$ pin, ( $V_P = 3.3$ V, $V_N = 0$ V)                          |              |              | 8.0          | $\mu$ A  |
| $I_{LEAK}$          | Channel Leakage Current   | CH pin to $V_N$ pin, $T_A = 25^\circ\text{C}$ ;<br>( $V_P = 5$ V, $V_N = 0$ V) |              | 0.1          | 1.0          | $\mu$ A  |
| $V_F$               | Diode Forward Voltage<br>Top Diode<br>Bottom Diode                  | $I_F = 8$ mA, $T_A = 25^\circ\text{C}$   | 0.60<br>0.60 | 0.80<br>0.80 | 0.95<br>0.95 | V        |
| $V_{BR}$            | Breakdown Voltage   | $I_T = 10$ mA, CH pin to $V_N$ pin   | 6.5          |              | 9.0          | V        |
| $C_{IN}$            | Channel Input Capacitance   | At 1 MHz, $V_P = 3.3$ V, $V_N = 0$ V, $V_{IN} = 1.65$ V<br>(Note 2)            |              | 0.85         | 1.2          | pF       |
| $\Delta C_{IN}$     | Channel Input Capacitance Matching                                  | At 1 MHz, $V_P = 3.3$ V, $V_N = 0$ V, $V_{IN} = 1.65$ V<br>(Note 2)            |              | 0.02         |              | pF       |
| $V_{CL}$            | Channel Clamp Voltage<br>Positive Transients<br>Negative Transients | $T_A = 25^\circ\text{C}$ , $I_{PP} = 1$ A, $t_P = 8/20$ $\mu$ s<br>(Note 2)    |              | +10<br>-1.7  |              | V        |
| $R_{DYN}$           | Dynamic Resistance<br>Positive Transients<br>Negative Transients    | $I_{PP} = 1$ A, $t_P = 8/20$ $\mu$ s<br>Any I/O pin to Ground<br>(Note 2)      |              | 0.9<br>0.5   |              | $\Omega$ |

Product parametric performance is indicated in the Electrical Characteristics for the listed test conditions, unless otherwise noted. Product performance may not be indicated by the Electrical Characteristics if operated under different conditions.

- All parameters specified at  $T_A = 25^\circ\text{C}$  unless otherwise noted.
- Standard IEC 61000-4-2 with  $C_{Discharge} = 150$  pF,  $R_{Discharge} = 330$   $\Omega$ ,  $V_P = 3.3$  V,  $V_N$  grounded.
- These measurements performed with no external capacitor on  $V_P$  ( $V_P$  floating).

# CM1213A, SZCM1213A

## PERFORMANCE INFORMATION

### Input Channel Capacitance Performance Curves

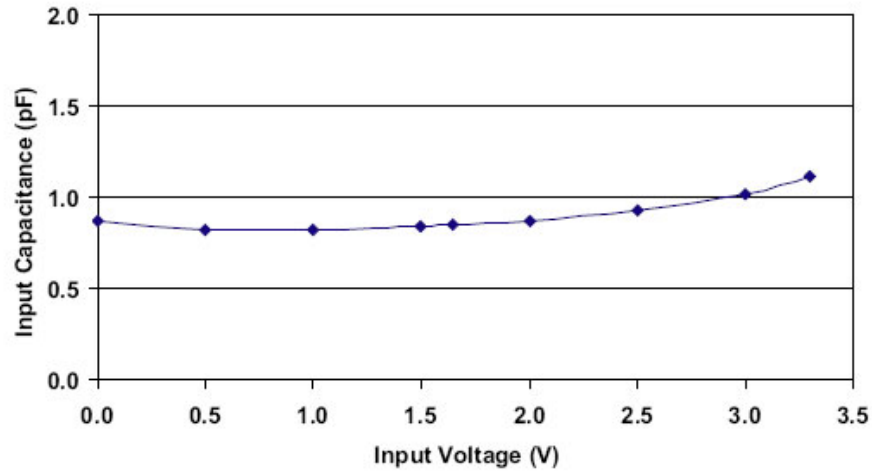

Figure 1. Typical Variation of  $C_{IN}$  vs.  $V_{IN}$   
( $f = 1 \text{ MHz}$ ,  $V_P = 3.3 \text{ V}$ ,  $V_N = 0 \text{ V}$ ,  $0.1 \mu\text{F}$  Chip Capacitor between  $V_P$  and  $V_N$ ,  $25^\circ\text{C}$ )

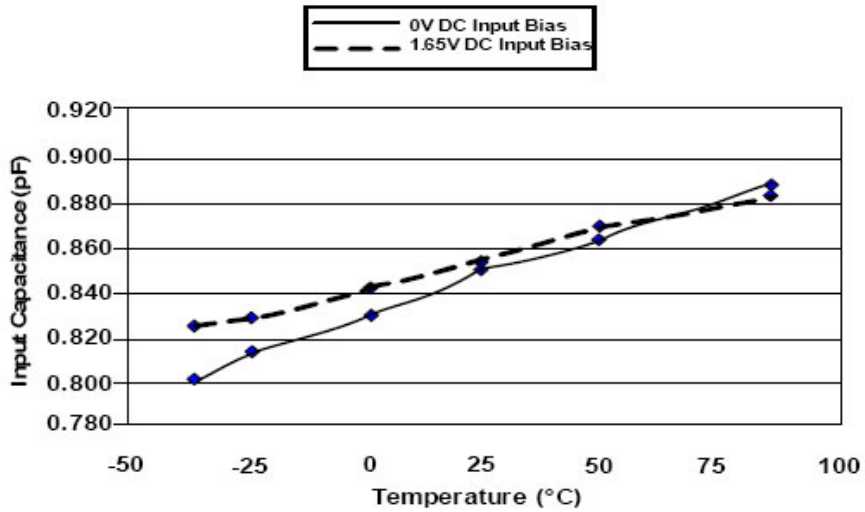

Figure 2. Typical Variation of  $C_{IN}$  vs. Temp  
( $f = 1 \text{ MHz}$ ,  $V_{IN} = 30 \text{ mV}$ ,  $V_P = 3.3 \text{ V}$ ,  $V_N = 0 \text{ V}$ ,  $0.1 \mu\text{F}$  Chip Capacitor between  $V_P$  and  $V_N$ )

# CM1213A, SZCM1213A

## PERFORMANCE INFORMATION (CONT'D)

Typical Filter Performance (nominal conditions unless specified otherwise, 50 Ohm Environment)

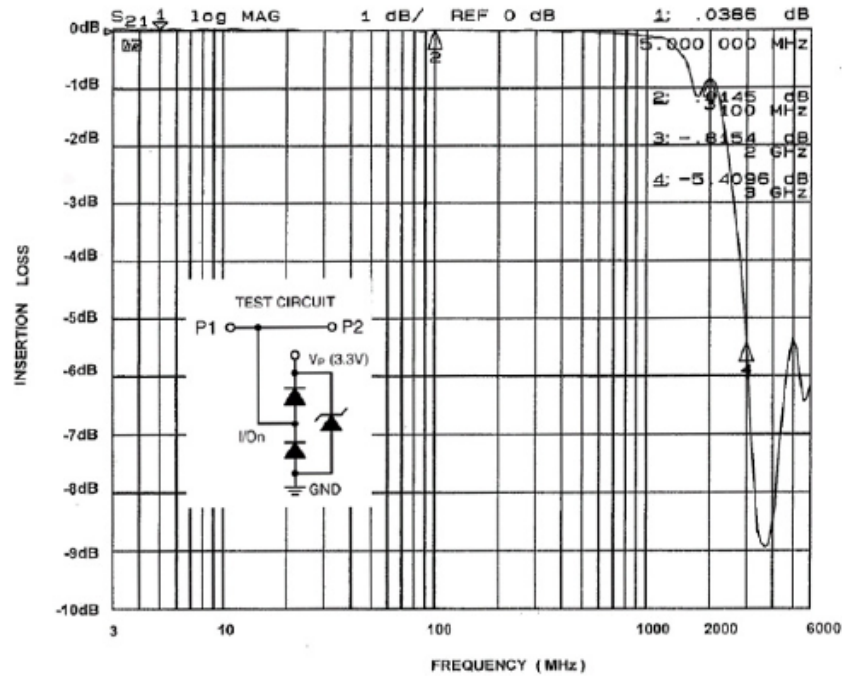

Figure 3. Insertion Loss (S21) vs. Frequency (0 V DC Bias,  $V_p=3.3$  V)

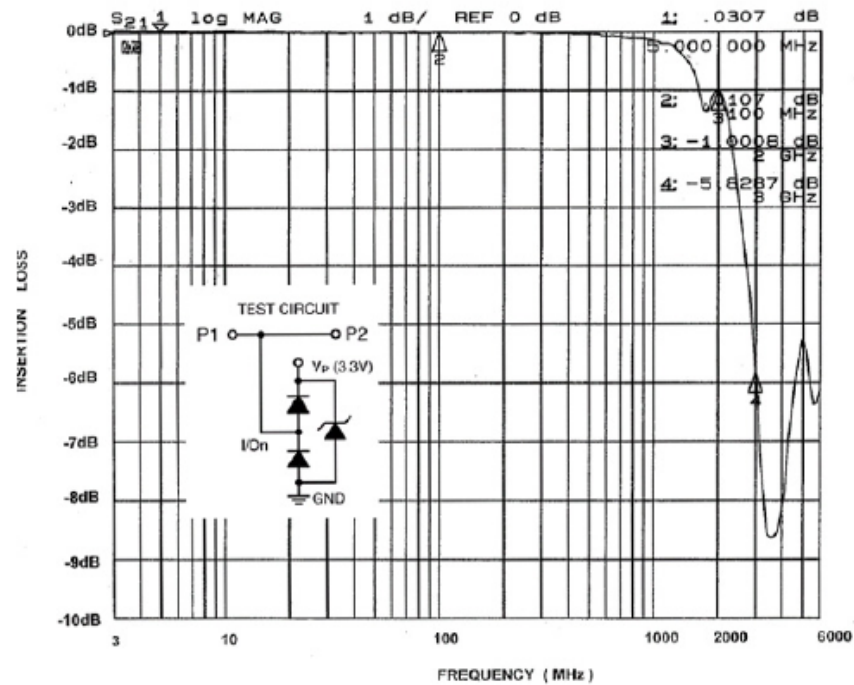

Figure 4. Insertion Loss (S21) vs. Frequency (2.5 V DC Bias,  $V_p=3.3$  V)

APPLICATION INFORMATION

**Design Considerations**

In order to realize the maximum protection against ESD pulses, care must be taken in the PCB layout to minimize parasitic series inductances on the Supply/Ground rails as well as the signal trace segment between the signal input (typically a connector) and the ESD protection device. Refer to Application of Positive ESD Pulse between Input Channel and Ground, which illustrates an example of a positive ESD pulse striking an input channel. The parasitic series inductance back to the power supply is represented by  $L_1$  and  $L_2$ . The voltage  $V_{CL}$  on the line being protected is:

$$V_{CL} = \text{Fwd Voltage Drop of } D_1 + V_{SUPPLY} + L_1 \times d(I_{ESD}) / dt + L_2 \times d(I_{ESD}) / dt$$

where  $I_{ESD}$  is the ESD current pulse, and  $V_{SUPPLY}$  is the positive supply voltage.

An ESD current pulse can rise from zero to its peak value in a very short time. As an example, a level 4 contact discharge per the IEC61000-4-2 standard results in a current pulse that rises from zero to 30 Amps in 1 ns. Here  $d(I_{ESD})/dt$  can be approximated by  $\Delta I_{ESD}/\Delta t$ , or  $30/(1 \times 10^{-9})$ . So just 10 nH of series inductance ( $L_1$  and  $L_2$  combined) will lead to a 300 V increment in  $V_{CL}$ !

Similarly for negative ESD pulses, parasitic series inductance from the  $V_N$  pin to the ground rail will lead to drastically increased negative voltage on the line being protected.

The CM1213A has an integrated Zener diode between  $V_P$  and  $V_N$ . This greatly reduces the effect of supply rail inductance  $L_2$  on  $V_{CL}$  by clamping  $V_P$  at the breakdown voltage of the Zener diode. However, for the lowest possible  $V_{CL}$ , especially when  $V_P$  is biased at a voltage significantly below the Zener breakdown voltage, it is recommended that a 0.22  $\mu F$  ceramic chip capacitor be connected between  $V_P$  and the ground plane.

As a general rule, the ESD Protection Array should be located as close as possible to the point of entry of expected electrostatic discharges. The power supply bypass capacitor mentioned above should be as close to the  $V_P$  pin of the Protection Array as possible, with minimum PCB trace lengths to the power supply, ground planes and between the signal input and the ESD device to minimize stray series inductance.

**Additional Information**

See also onsemi Application Note “Design Considerations for ESD Protection”, in the Applications section.

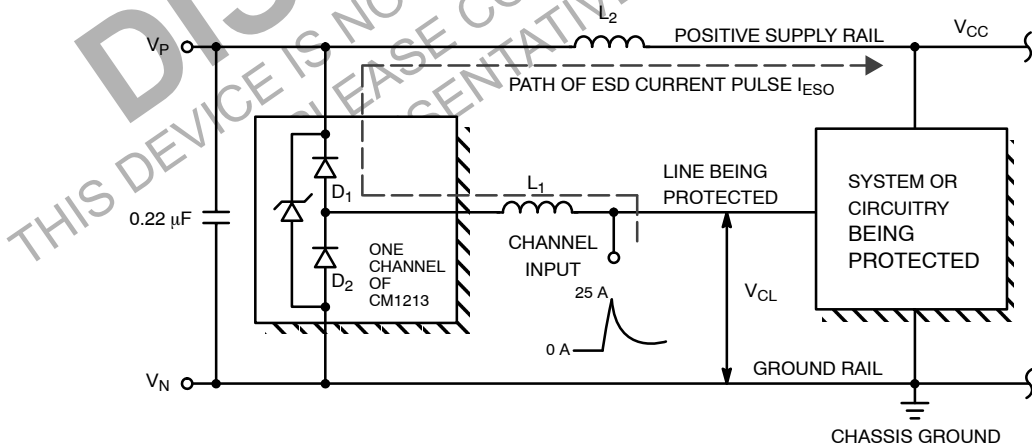
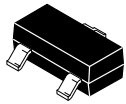

Figure 5. Application of Positive ESD Pulse between Input Channel and Ground





SCALE 4:1

**SOT-23 (TO-236) 2.90x1.30x1.00 1.90P**  
**CASE 318**  
**ISSUE AU**

DATE 14 AUG 2024

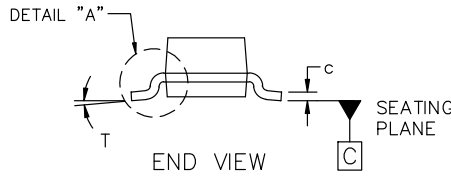
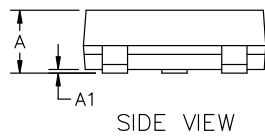
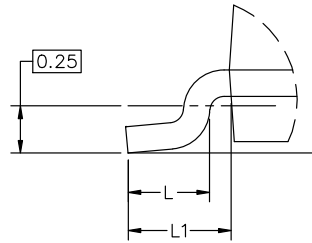
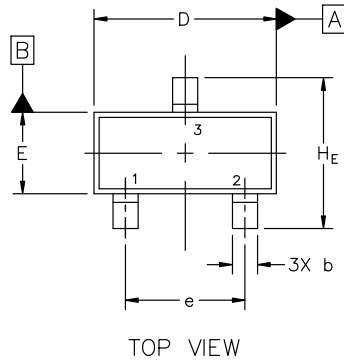

| MILLIMETERS |      |      |      |
|-------------|------|------|------|
| DIM         | MIN  | NOM  | MAX  |
| A           | 0.89 | 1.00 | 1.11 |
| A1          | 0.01 | 0.06 | 0.10 |
| b           | 0.37 | 0.44 | 0.50 |
| c           | 0.08 | 0.14 | 0.20 |
| D           | 2.80 | 2.90 | 3.04 |
| E           | 1.20 | 1.30 | 1.40 |
| e           | 1.78 | 1.90 | 2.04 |
| L           | 0.30 | 0.43 | 0.55 |
| L1          | 0.35 | 0.54 | 0.69 |
| HE          | 2.10 | 2.40 | 2.64 |
| T           | 0°   | ---  | 10°  |

NOTES:

1. DIMENSIONING AND TOLERANCING PER ASME Y14.5M, 2018.
2. CONTROLLING DIMENSIONS: MILLIMETERS.
3. MAXIMUM LEAD THICKNESS INCLUDES LEAD FINISH. MINIMUM LEAD THICKNESS IS THE MINIMUM THICKNESS OF THE BASE MATERIAL.
4. DIMENSIONS D AND E DO NOT INCLUDE MOLD FLASH, PROTRUSIONS, OR GATE BURRS.

**GENERIC MARKING DIAGRAM\***

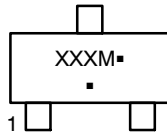

XXX = Specific Device Code  
M = Date Code  
▪ = Pb-Free Package

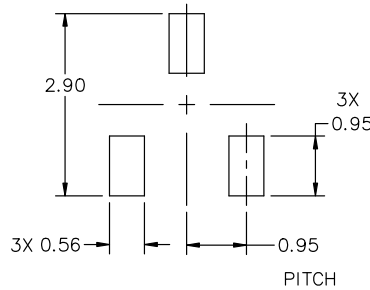

\* For additional information on our Pb-Free strategy and soldering details, please download the onsemi Soldering and Mounting Techniques Reference Manual, SOLDERRM/D.

\*This information is generic. Please refer to device data sheet for actual part marking. Pb-Free indicator, "G" or microdot "▪", may or may not be present. Some products may not follow the Generic Marking.

**STYLES ON PAGE 2**

|                         |   |  |
|-------------------------|---|--|
| <b>DOCUMENT NUMBER:</b> | <b>98ASB42226B</b>                          | Electronic versions are uncontrolled except when accessed directly from the Document Repository. Printed versions are uncontrolled except when stamped "CONTROLLED COPY" in red. |
| <b>DESCRIPTION:</b>     | <b>SOT-23 (TO-236) 2.90x1.30x1.00 1.90P</b> | <b>PAGE 1 OF 2</b>   |

onsemi and ONSEMI are trademarks of Semiconductor Components Industries, LLC dba onsemi or its subsidiaries in the United States and/or other countries. onsemi reserves the right to make changes without further notice to any products herein. onsemi makes no warranty, representation or guarantee regarding the suitability of its products for any particular purpose, nor does onsemi assume any liability arising out of the application or use of any product or circuit, and specifically disclaims any and all liability, including without limitation special, consequential or incidental damages. onsemi does not convey any license under its patent rights nor the rights of others.



**SOT-23 (TO-236) 2.90x1.30x1.00 1.90P**  
**CASE 318**  
**ISSUE AU**

DATE 14 AUG 2024

STYLE 1 THRU 5:  
CANCELLED

STYLE 6:  
PIN 1. BASE  
2. EMITTER  
3. COLLECTOR

STYLE 7:  
PIN 1. EMITTER  
2. BASE  
3. COLLECTOR

STYLE 8:  
PIN 1. ANODE  
2. NO CONNECTION  
3. CATHODE

STYLE 9:  
PIN 1. ANODE  
2. ANODE  
3. CATHODE

STYLE 10:  
PIN 1. DRAIN  
2. SOURCE  
3. GATE

STYLE 11:  
PIN 1. ANODE  
2. CATHODE  
3. CATHODE-ANODE

STYLE 12:  
PIN 1. CATHODE  
2. CATHODE  
3. ANODE

STYLE 13:  
PIN 1. SOURCE  
2. DRAIN  
3. GATE

STYLE 14:  
PIN 1. CATHODE  
2. GATE  
3. ANODE

STYLE 15:  
PIN 1. GATE  
2. CATHODE  
3. ANODE

STYLE 16:  
PIN 1. ANODE  
2. CATHODE  
3. CATHODE

STYLE 17:  
PIN 1. NO CONNECTION  
2. ANODE  
3. CATHODE

STYLE 18:  
PIN 1. NO CONNECTION  
2. CATHODE  
3. ANODE

STYLE 19:  
PIN 1. CATHODE  
2. ANODE  
3. CATHODE-ANODE

STYLE 20:  
PIN 1. CATHODE  
2. ANODE  
3. GATE

STYLE 21:  
PIN 1. GATE  
2. SOURCE  
3. DRAIN

STYLE 22:  
PIN 1. RETURN  
2. OUTPUT  
3. INPUT

STYLE 23:  
PIN 1. ANODE  
2. ANODE  
3. CATHODE

STYLE 24:  
PIN 1. GATE  
2. DRAIN  
3. SOURCE

STYLE 25:  
PIN 1. ANODE  
2. CATHODE  
3. GATE

STYLE 26:  
PIN 1. CATHODE  
2. ANODE  
3. NO CONNECTION

STYLE 27:  
PIN 1. CATHODE  
2. CATHODE  
3. CATHODE

STYLE 28:  
PIN 1. ANODE  
2. ANODE  
3. ANODE

|                         |   |   |
|-------------------------|---|---|
| <b>DOCUMENT NUMBER:</b> | <b>98ASB42226B</b>                          | Electronic versions are uncontrolled except when accessed directly from the Document Repository.<br>Printed versions are uncontrolled except when stamped "CONTROLLED COPY" in red. |
| <b>DESCRIPTION:</b>     | <b>SOT-23 (TO-236) 2.90x1.30x1.00 1.90P</b> | <b>PAGE 2 OF 2</b>  |

**onsemi** and **ONSEMI** are trademarks of Semiconductor Components Industries, LLC dba **onsemi** or its subsidiaries in the United States and/or other countries. **onsemi** reserves the right to make changes without further notice to any products herein. **onsemi** makes no warranty, representation or guarantee regarding the suitability of its products for any particular purpose, nor does **onsemi** assume any liability arising out of the application or use of any product or circuit, and specifically disclaims any and all liability, including without limitation special, consequential or incidental damages. **onsemi** does not convey any license under its patent rights nor the rights of others.

# MECHANICAL CASE OUTLINE PACKAGE DIMENSIONS

ON Semiconductor®

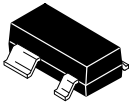

SCALE 4:1

## SOT-143 CASE 318A-06 ISSUE U

DATE 07 SEP 2011

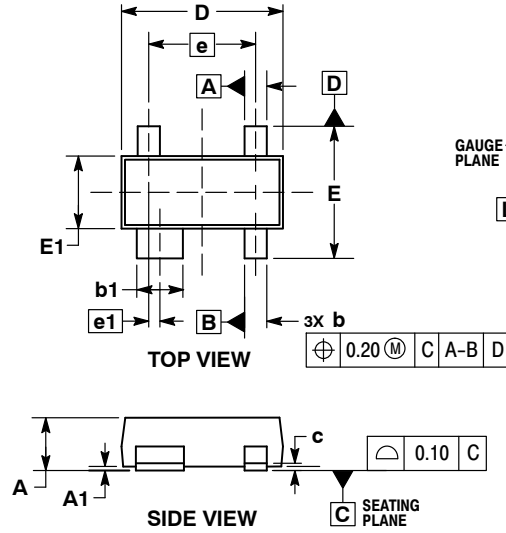

**NOTES:**

1. DIMENSIONING AND TOLERANCING PER ASME Y14.5M, 1994.
2. CONTROLLING DIMENSION: MILLIMETERS.
3. MAXIMUM LEAD THICKNESS INCLUDES LEAD FINISH. MINIMUM LEAD THICKNESS IS THE MINIMUM THICKNESS OF BASE MATERIAL.
4. DIMENSIONS D AND E DO NOT INCLUDE MOLD FLASH, PROTRUSIONS, OR GATE BURRS. MOLD FLASH, PROTRUSIONS, AND GATE BURRS SHALL NOT EXCEED 0.25 PER SIDE. DIMENSION E1 DOES NOT INCLUDE INTERLEAD FLASH OR PROTRUSION. INTERLEAD FLASH AND PROTRUSION SHALL NOT EXCEED 0.25 PER SIDE.
5. DIMENSIONS D AND E1 ARE DETERMINED AT DATUM H.
6. DATUMS A AND B ARE DETERMINED AT DATUM H.

| DIM | MILLIMETERS |      |
|-----|-------------|------|
|     | MIN         | MAX  |
| A   | 0.80        | 1.12 |
| A1  | 0.01        | 0.15 |
| b   | 0.30        | 0.51 |
| b1  | 0.76        | 0.94 |
| c   | 0.08        | 0.20 |
| D   | 2.80        | 3.05 |
| E   | 2.10        | 2.64 |
| E1  | 1.20        | 1.40 |
| e   | 1.92 BSC    |      |
| e1  | 0.20 BSC    |      |
| L   | 0.35        | 0.70 |
| L2  | 0.25 BSC    |      |

### RECOMMENDED SOLDERING FOOTPRINT

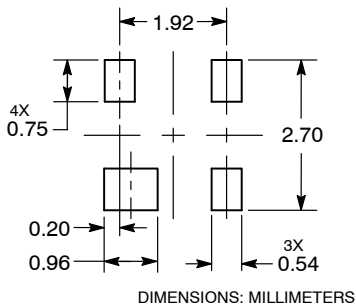

### GENERIC MARKING DIAGRAM\*

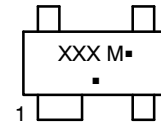

XXX = Specific Device Code  
M = Date Code  
▪ = Pb-Free Package

(Note: Microdot may be in either location)

\*This information is generic. Please refer to device data sheet for actual part marking. Pb-Free indicator, "G" or microdot "▪", may or may not be present.

- |   |   |   |   |  |  |
|---|---|---|---|--|--|
| <p><b>STYLE 1:</b><br/>PIN 1. COLLECTOR<br/>2. EMITTER<br/>3. EMITTER<br/>4. BASE</p> | <p><b>STYLE 2:</b><br/>PIN 1. SOURCE<br/>2. DRAIN<br/>3. GATE 1<br/>4. GATE 2</p> | <p><b>STYLE 3:</b><br/>PIN 1. GROUND<br/>2. SOURCE<br/>3. INPUT<br/>4. OUTPUT</p> | <p><b>STYLE 4:</b><br/>PIN 1. OUTPUT<br/>2. GROUND<br/>3. GROUND<br/>4. INPUT</p> | <p><b>STYLE 5:</b><br/>PIN 1. SOURCE<br/>2. DRAIN<br/>3. GATE 1<br/>4. SOURCE</p>  | <p><b>STYLE 6:</b><br/>PIN 1. GND<br/>2. RF IN<br/>3. VREG<br/>4. RF OUT</p> |
| <p><b>STYLE 7:</b><br/>PIN 1. SOURCE<br/>2. GATE<br/>3. DRAIN<br/>4. SOURCE</p>       | <p><b>STYLE 8:</b><br/>PIN 1. SOURCE<br/>2. GATE<br/>3. DRAIN<br/>4. N/C</p>      | <p><b>STYLE 9:</b><br/>PIN 1. GND<br/>2. IOUT<br/>3. VCC<br/>4. VREF</p>          | <p><b>STYLE 10:</b><br/>PIN 1. DRAIN<br/>2. N/C<br/>3. SOURCE<br/>4. GATE</p>     | <p><b>STYLE 11:</b><br/>PIN 1. SOURCE<br/>2. GATE 1<br/>3. GATE 2<br/>4. DRAIN</p> |  |

|                         |                    |  |
|-------------------------|--------------------|--|
| <b>DOCUMENT NUMBER:</b> | <b>98ASB42227B</b> | Electronic versions are uncontrolled except when accessed directly from the Document Repository. Printed versions are uncontrolled except when stamped "CONTROLLED COPY" in red. |
| <b>DESCRIPTION:</b>     | <b>SOT-143</b>     | <b>PAGE 1 OF 1</b>   |

ON Semiconductor and ON are trademarks of Semiconductor Components Industries, LLC dba ON Semiconductor or its subsidiaries in the United States and/or other countries. ON Semiconductor reserves the right to make changes without further notice to any products herein. ON Semiconductor makes no warranty, representation or guarantee regarding the suitability of its products for any particular purpose, nor does ON Semiconductor assume any liability arising out of the application or use of any product or circuit, and specifically disclaims any and all liability, including without limitation special, consequential or incidental damages. ON Semiconductor does not convey any license under its patent rights nor the rights of others.



SCALE 2:1

SC-74  
CASE 318F  
ISSUE P

DATE 07 OCT 2021

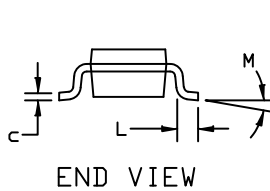
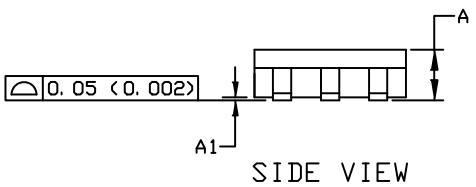
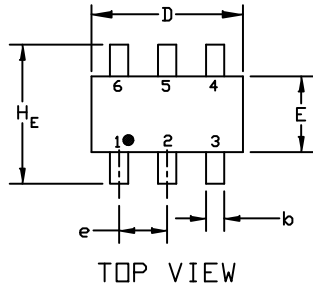

GENERIC  
MARKING DIAGRAM\*

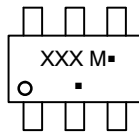

XXX = Specific Device Code  
M = Date Code  
▪ = Pb-Free Package

(Note: Microdot may be in either location)

\*This information is generic. Please refer to device data sheet for actual part marking. Pb-Free indicator, "G" or microdot "▪", may or may not be present. Some products may not follow the Generic Marking.

NOTES:

1. DIMENSIONING AND TOLERANCING PER ASME Y14.5M, 1994
2. CONTROLLING DIMENSION: INCHES
3. MAXIMUM LEAD THICKNESS INCLUDES LEAD FINISH THICKNESS. MINIMUM LEAD THICKNESS IS THE MINIMUM THICKNESS OF THE BASE MATERIAL.

| DIM | MILLIMETERS |      |      | INCHES |       |       |
|-----|-------------|------|------|--------|-------|-------|
|     | MIN.        | NOM. | MAX. | MIN.   | NOM.  | MAX.  |
| A   | 0.90        | 1.00 | 1.10 | 0.035  | 0.039 | 0.043 |
| A1  | 0.01        | 0.06 | 0.10 | 0.001  | 0.002 | 0.004 |
| b   | 0.25        | 0.37 | 0.50 | 0.010  | 0.015 | 0.020 |
| c   | 0.10        | 0.18 | 0.26 | 0.004  | 0.007 | 0.010 |
| D   | 2.90        | 3.00 | 3.10 | 0.114  | 0.118 | 0.122 |
| E   | 1.30        | 1.50 | 1.70 | 0.051  | 0.059 | 0.067 |
| e   | 0.85        | 0.95 | 1.05 | 0.034  | 0.037 | 0.041 |
| HE  | 2.50        | 2.75 | 3.00 | 0.099  | 0.108 | 0.118 |
| L   | 0.20        | 0.40 | 0.60 | 0.008  | 0.016 | 0.024 |
| M   | 0*          | ---  | 10*  | 0*     | ---   | 10*   |

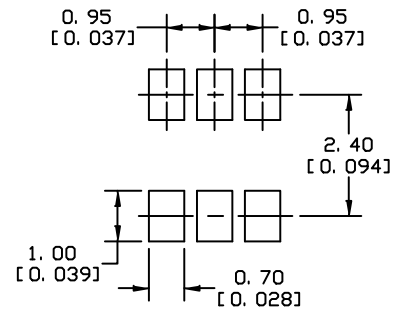

\* For additional information on our Pb-Free strategy and soldering details, please download the DN Semiconductor Soldering and Mounting Techniques Reference Manual, SOLDERM/D.

SOLDERING FOOTPRINT

|   |  |   |  |   |   |
|---|--|---|--|---|---|
| <p>STYLE 1:<br/>PIN 1. CATHODE<br/>2. ANODE<br/>3. CATHODE<br/>4. CATHODE<br/>5. ANODE<br/>6. CATHODE</p>     | <p>STYLE 2:<br/>PIN 1. NO CONNECTION<br/>2. COLLECTOR<br/>3. EMITTER<br/>4. NO CONNECTION<br/>5. COLLECTOR<br/>6. BASE</p> | <p>STYLE 3:<br/>PIN 1. EMITTER 1<br/>2. BASE 1<br/>3. COLLECTOR 2<br/>4. EMITTER 2<br/>5. BASE 2<br/>6. COLLECTOR 1</p> | <p>STYLE 4:<br/>PIN 1. COLLECTOR 2<br/>2. EMITTER 1/EMITTER 2<br/>3. COLLECTOR 1<br/>4. EMITTER 3<br/>5. BASE 1/BASE 2/COLLECTOR 3<br/>6. BASE 3</p> | <p>STYLE 5:<br/>PIN 1. CHANNEL 1<br/>2. ANODE<br/>3. CHANNEL 2<br/>4. CHANNEL 3<br/>5. CATHODE<br/>6. CHANNEL 4</p> | <p>STYLE 6:<br/>PIN 1. CATHODE<br/>2. ANODE<br/>3. CATHODE<br/>4. CATHODE<br/>5. CATHODE<br/>6. CATHODE</p> |
| <p>STYLE 7:<br/>PIN 1. SOURCE 1<br/>2. GATE 1<br/>3. DRAIN 2<br/>4. SOURCE 2<br/>5. GATE 2<br/>6. DRAIN 1</p> | <p>STYLE 8:<br/>PIN 1. EMITTER 1<br/>2. BASE 2<br/>3. COLLECTOR 2<br/>4. EMITTER 2<br/>5. BASE 1<br/>6. COLLECTOR 1</p>    | <p>STYLE 9:<br/>PIN 1. EMITTER 2<br/>2. BASE 2<br/>3. COLLECTOR 1<br/>4. EMITTER 1<br/>5. BASE 1<br/>6. COLLECTOR 2</p> | <p>STYLE 10:<br/>PIN 1. ANODE/CATHODE<br/>2. BASE<br/>3. EMITTER<br/>4. COLLECTOR<br/>5. ANODE<br/>6. CATHODE</p>                                    | <p>STYLE 11:<br/>PIN 1. EMITTER<br/>2. BASE<br/>3. ANODE/CATHODE<br/>4. ANODE<br/>5. CATHODE<br/>6. COLLECTOR</p>   |   |

|                  |             |  |
|------------------|-------------|--|
| DOCUMENT NUMBER: | 98ASB42973B | Electronic versions are uncontrolled except when accessed directly from the Document Repository. Printed versions are uncontrolled except when stamped "CONTROLLED COPY" in red. |
| DESCRIPTION:     | SC-74       | PAGE 1 OF 1  |

onsemi and ONSEMI are trademarks of Semiconductor Components Industries, LLC dba onsemi or its subsidiaries in the United States and/or other countries. onsemi reserves the right to make changes without further notice to any products herein. onsemi makes no warranty, representation or guarantee regarding the suitability of its products for any particular purpose, nor does onsemi assume any liability arising out of the application or use of any product or circuit, and specifically disclaims any and all liability, including without limitation special, consequential or incidental damages. onsemi does not convey any license under its patent rights nor the rights of others.

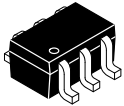

1

**SC-88 (SC-70 6 Lead), 1.25x2**  
**CASE 419AD**  
**ISSUE A**

DATE 07 JUL 2010

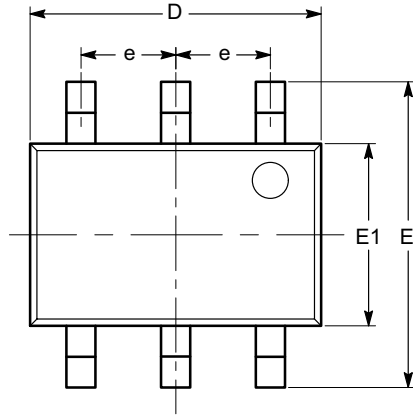

TOP VIEW

| SYMBOL     | MIN      | NOM  | MAX  |
|------------|----------|------|------|
| A          | 0.80     |      | 1.10 |
| A1         | 0.00     |      | 0.10 |
| A2         | 0.80     |      | 1.00 |
| b          | 0.15     |      | 0.30 |
| c          | 0.10     |      | 0.18 |
| D          | 1.80     | 2.00 | 2.20 |
| E          | 1.80     | 2.10 | 2.40 |
| E1         | 1.15     | 1.25 | 1.35 |
| e          | 0.65 BSC |      |      |
| L          | 0.26     | 0.36 | 0.46 |
| L1         | 0.42 REF |      |      |
| L2         | 0.15 BSC |      |      |
| $\theta$   | 0°       |      | 8°   |
| $\theta_1$ | 4°       |      | 10°  |

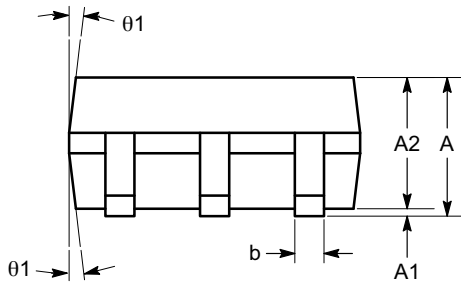

SIDE VIEW

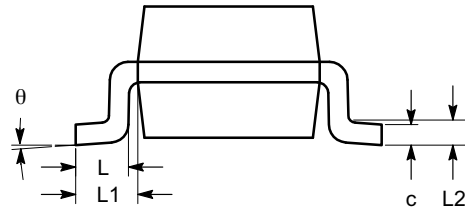

END VIEW

**Notes:**

- (1) All dimensions are in millimeters. Angles in degrees.
- (2) Complies with JEDEC MO-203.

|                         |                                     |  |
|-------------------------|-------------------------------------|--|
| <b>DOCUMENT NUMBER:</b> | <b>98AON34266E</b>                  | Electronic versions are uncontrolled except when accessed directly from the Document Repository. Printed versions are uncontrolled except when stamped "CONTROLLED COPY" in red. |
| <b>DESCRIPTION:</b>     | <b>SC-88 (SC-70 6 LEAD), 1.25X2</b> | <b>PAGE 1 OF 1</b>   |

onsemi and Onsemi are trademarks of Semiconductor Components Industries, LLC dba onsemi or its subsidiaries in the United States and/or other countries. onsemi reserves the right to make changes without further notice to any products herein. onsemi makes no warranty, representation or guarantee regarding the suitability of its products for any particular purpose, nor does onsemi assume any liability arising out of the application or use of any product or circuit, and specifically disclaims any and all liability, including without limitation special, consequential or incidental damages. onsemi does not convey any license under its patent rights nor the rights of others.



**onsemi**, **Onsemi**, and other names, marks, and brands are registered and/or common law trademarks of Semiconductor Components Industries, LLC dba "**onsemi**" or its affiliates and/or subsidiaries in the United States and/or other countries. **onsemi** owns the rights to a number of patents, trademarks, copyrights, trade secrets, and other intellectual property. A listing of **onsemi**'s product/patent coverage may be accessed at [www.onsemi.com/site/pdf/Patent-Marking.pdf](http://www.onsemi.com/site/pdf/Patent-Marking.pdf). **onsemi** reserves the right to make changes at any time to any products or information herein, without notice. The information herein is provided "as-is" and **onsemi** makes no warranty, representation or guarantee regarding the accuracy of the information, product features, availability, functionality, or suitability of its products for any particular purpose, nor does **onsemi** assume any liability arising out of the application or use of any product or circuit, and specifically disclaims any and all liability, including without limitation special, consequential or incidental damages. Buyer is responsible for its products and applications using **onsemi** products, including compliance with all laws, regulations and safety requirements or standards, regardless of any support or applications information provided by **onsemi**. "Typical" parameters which may be provided in **onsemi** data sheets and/or specifications can and do vary in different applications and actual performance may vary over time. All operating parameters, including "Typicals" must be validated for each customer application by customer's technical experts. **onsemi** does not convey any license under any of its intellectual property rights nor the rights of others. **onsemi** products are not designed, intended, or authorized for use as a critical component in life support systems or any FDA Class 3 medical devices or medical devices with a same or similar classification in a foreign jurisdiction or any devices intended for implantation in the human body. Should Buyer purchase or use **onsemi** products for any such unintended or unauthorized application, Buyer shall indemnify and hold **onsemi** and its officers, employees, subsidiaries, affiliates, and distributors harmless against all claims, costs, damages, and expenses, and reasonable attorney fees arising out of, directly or indirectly, any claim of personal injury or death associated with such unintended or unauthorized use, even if such claim alleges that **onsemi** was negligent regarding the design or manufacture of the part. **onsemi** is an Equal Opportunity/Affirmative Action Employer. This literature is subject to all applicable copyright laws and is not for resale in any manner.

---

## ADDITIONAL INFORMATION

### TECHNICAL PUBLICATIONS:

Technical Library: [www.onsemi.com/design/resources/technical-documentation](http://www.onsemi.com/design/resources/technical-documentation)  
onsemi Website: [www.onsemi.com](http://www.onsemi.com)

### ONLINE SUPPORT: [www.onsemi.com/support](http://www.onsemi.com/support)

For additional information, please contact your local Sales Representative at [www.onsemi.com/support/sales](http://www.onsemi.com/support/sales)