

Solutions for Defense Applications Certified to VG Standards

VG Products - Approved by BAAINBw

Table of Contents

VG 95218 Wire & Cable

Introduction	8
VG 95218 Part 20 Type A	9
VG 95218 Part 20 Type E	10
VG 95218 Part 20 Type G	11
VG 95218 Part 21 Type A	12
VG 95218 Part 21 Type C	13
VG 95218 Part 21 Type E	16
VG 95218 Part 22 Type C	19
VG 95218 Part 22 Type D	20
VG 95218 Part 23 Type C	21
VG 95218 Part 23 Type F	25
VG 95218 Part 24 Type K	30
VG 95218 Part 25 Type G	31
VG 95218 Part 27 Type A	32
VG 95218 Part 27 Type B	34
VG 95218 Part 28 Type A	36
VG 95218 Part 28 Type B	42
VG 95218 Part 28 Type C	44
VG 95218 Part 28 Type D	64
VG 95218 Part 28 Type E	76
VG 95218 Part 61 to 66	82

VG 95343 Heat Shrink Products

Introduction	86
VG 95343 T05 Heat Shrink Tube	87
VG 95343 T06 Molded Parts	88
VG 95343 T07 Molded Parts	90
VG 95343 T08 Transition Molded Parts	92
VG 95343 T09 Transition Molded Parts	94
VG 95343 T15 Adhesive	95
VG 95343 T18 Molded Parts	96
VG 95343 T19 Transition Molded Parts	98
VG 95343 T25 Feedthrough Molded Parts	100
VG 95343 T28 Zerohal Molded Parts	103
VG 95343 T29 Zerohal Molded Parts	105
VG 95343 T30 Zerohal Transition Molded Parts	106

VG 96936 Shielding

VG 96936 T10 Raybraid: Ray 101 and Ray 90	108
---	-----

VG 95236 Tooling

VG 95236 T13 Heat Guns and Reflectors	109
---------------------------------------	-----

VG 96933 Crimp Splices

VG 96933 T105 Crimp Splices	110
-----------------------------	-----

VG 95319 SolderTacts Contacts

VG 95319 T10 Shielded One-Piece Solder Contacts	111
---	-----

VG 95319 Connectors

Introduction	112
VG 95319 Connectors with DEUTSCH DTS and ACT Series Connectors Cross-Reference	113
- DEUTSCH Square Flange Receptacle - Type 20	116
- DEUTSCH Jam Nut Receptacle - Type 24	117
- DEUTSCH Plug - Type 26	118
- DEUTSCH Square Flange Receptacle to Plug	119
- DEUTSCH Jam Nut Receptacle to Plug	119
- DEUTSCH Dummy Receptacle - Type PR	120
- Recommended Panel Cutouts & Keying Options	121

VG 95319 Backshells & Accessories

Introduction & Overview	122
VG 95319-1011A001A - Band Termination	125
VG 95319-1011B001A - Band Termination (90°)	126
VG 95319-1011C001A - Cone Termination	127
VG 95319-1011D001A - Band Termination	128
VG 95319-1011E001A - Heat Shrink Boot Backshell	129
VG 95319-1011F001A - Cone Termination	130
VG 95319-1011G001A - Band Termination	131
VG 95319-1011H001A - Band Termination (90°)	132
VG 95319-1015A Band Straps	133

VG 96928 Relays

VG 96928 - 41,42,43,44 HARTMAN Contactors	134
VG 96928 - 03,04,06,08,21,23 KISSLING Relays	136

VG 96935-6 Relays

VG 96935-6 CII Low Signal Relays	138
----------------------------------	-----

VG 95318 Switches

VG 95318 - 11 KISSLING Toggle Switch	139
VG 95318 - 14 KISSLING Blackout Light Switch	140

VG 95210 Limit Switches

VG 95210 - KISSLING Limit Switch - G12	141
VG 95210 - KISSLING Limit Switch - G13	142

VG 96927-2 Harness Assemblies

VG 96927-2 Integrated Military Harness Systems	143
--	-----

Abbreviations	145
---------------	-----

VG Products - Approved by BAANBw



Introduction

For more than 50 years, TE Connectivity (TE) has been providing end-to-end interconnection solutions for wire and cable looms and harnesses for defense applications for the air, land, and sea. TE is proud of our long association with the Bundeswehr, Germany's unified armed forces and the Federal Office of Bundeswehr Equipment, Information Technology and In-Service Support (BAANBw in German) which is leading the standardization. TE has earned the prestigious VG designation on various products qualified to these military standards. These standards are recognized by NATO (North Atlantic Treaty Organization) aligned countries including Armatusuisse (The Federal Office Defense Procurement) and Ministerie van Defensie (Netherlands).

As a pioneer of cross-linking polymer material science and technology, TE has developed wire and cables, wire splicing, and harness protection products that provide optimum mechanical protection and fluid resistance in environments where failure is not an option - like the optical systems on a main battle tank, a remote weapons system on an all-terrain vehicle, the radar system on a sea going destroyer or the missile launch systems on an aircraft.

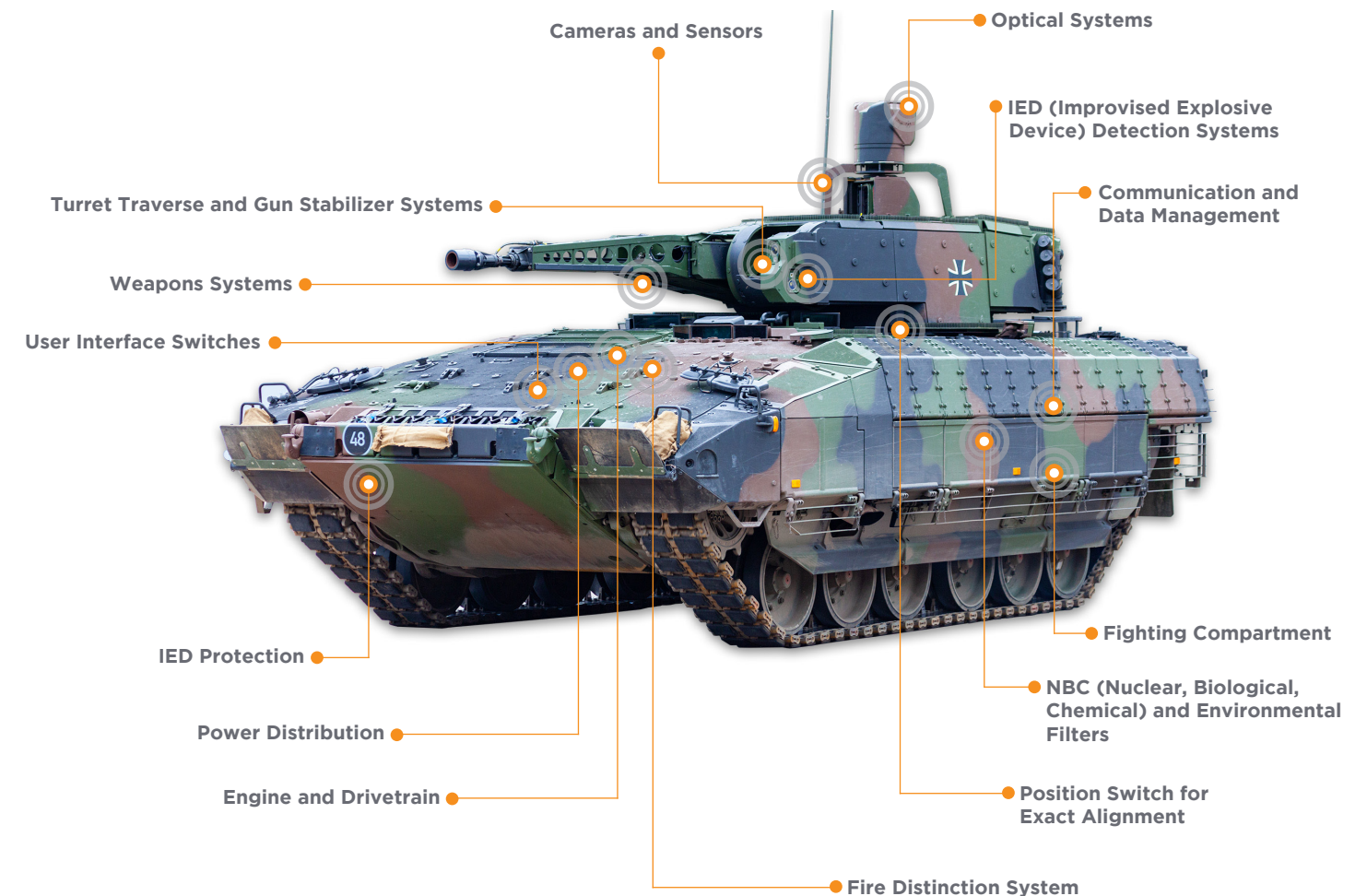



Whether you buy directly from TE or through one of our experienced distribution partners, this catalogue brings you a useful cross reference guide to TE's VG qualified products. It includes wire and harnessing products, metal braids and some higher temperature products, and our wire splices for both manufacturing and MRO (Maintenance, Repair and Overhaul) solutions. TE further offers VG approved relays, switches, connectors and circular backshells which interface on to the connector and provide the platform for the screen termination or VG heat shrink boots.

We also supply a comprehensive range of heating and crimping tools and have a wealth of knowledge and expertise to help guide you in product selection.

Our VG qualified parts are released according to the performance and functional standard agreed with the Federal Office of Bundeswehr Equipment, Information Technology and In-Service Support (BAAINBw in German) following extensive product testing. Requalification is undertaken at regular intervals to ensure our products continue to meet those high standards.

The various VG standards, from initiation through application to approval, are analogous to the United States military standard, often referred to as MIL-STD or MIL-SPEC.

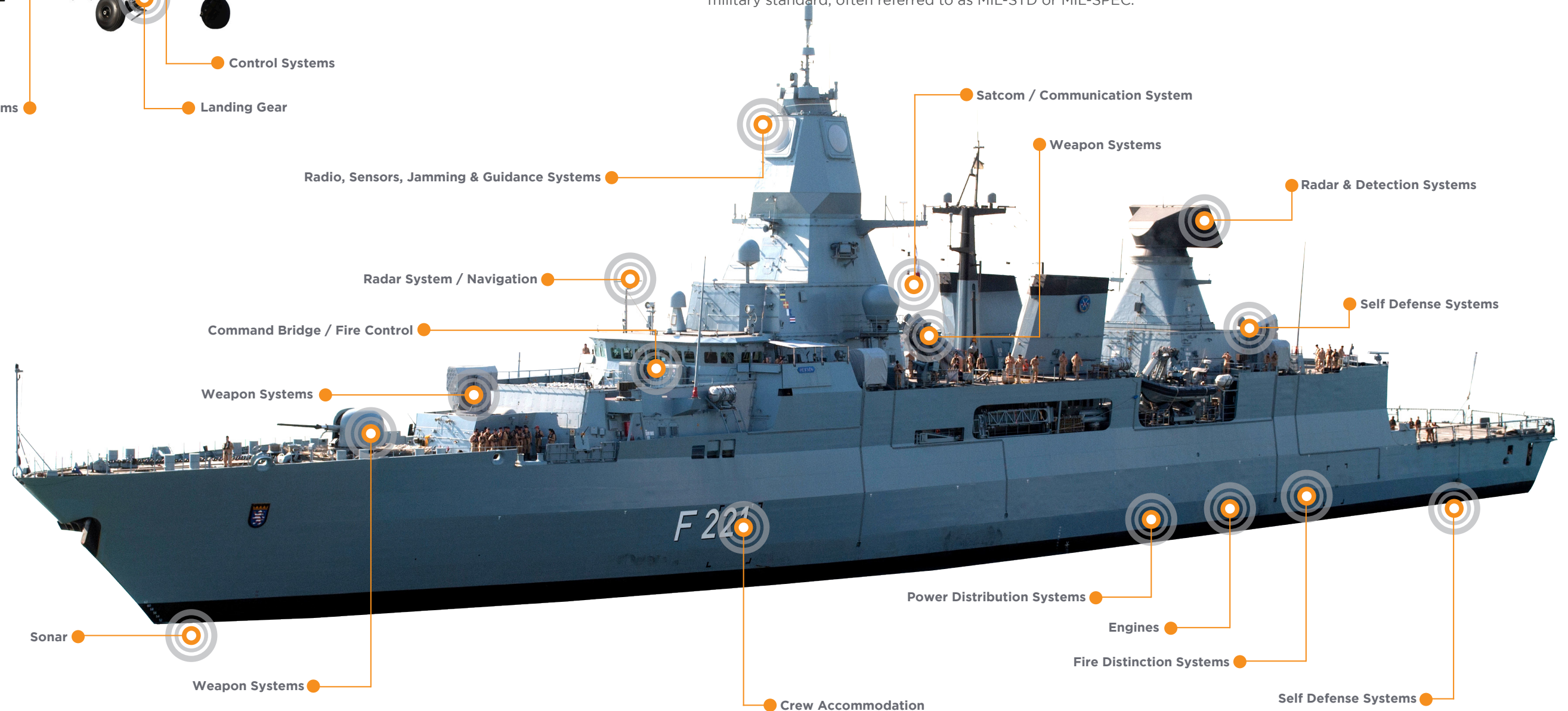

System Compatibility



It has long been recognized in the defense industry that the increasing performance and protection demands placed on equipment by global military platforms needs a robust and reliable environmental solution for electrical wire & cable harnesses.

TE's integrated harness systems have been developed for a wide range of defense and industrial applications. Each system consists of compatible components, including wire and cable, EMI shielding braid, heat shrinkable components, adhesives and connector accessories. Performance of these components is assured because all components are tested separately and as part of an assembled system.

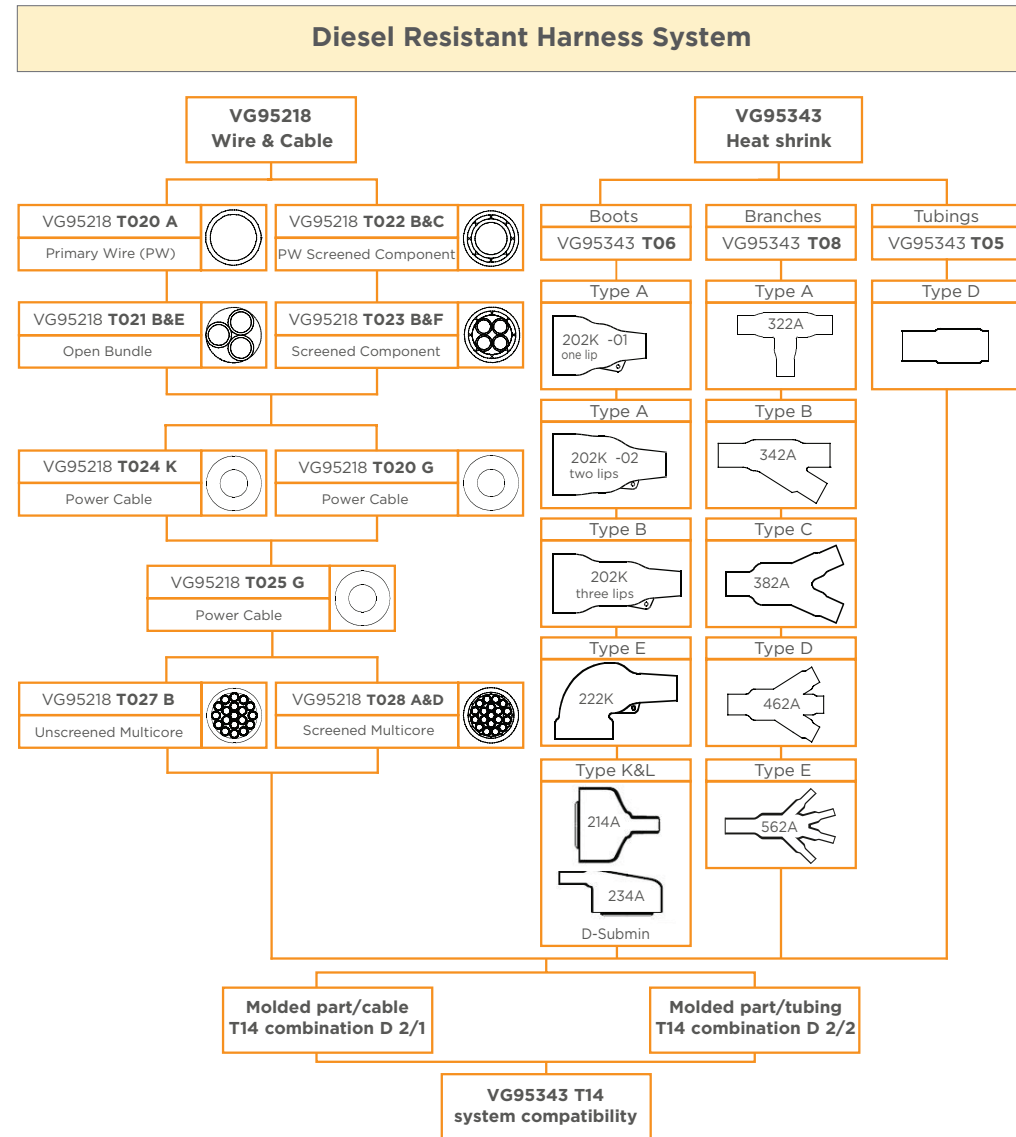

TE's System 25 was designed to provide tough, flexible, fluid resistant characteristics with a wide operating temperature range of -75°C to +150°C, and a balance of other properties to enhance the system performance. System 25 components are especially suited for military vehicles, aerospace and marine applications, communication and test equipment and is also used in the automotive and motorsport industries. Resistant to most common military fuels, oils and greases up to +70°C, these materials are flame resistant and self-extinguishing.

System Compatibility



TE's System 100 was designed to provide halogen free, low fire hazard (LFH) characteristics. It is especially suitable for confined habitat areas in military, industrial and civil applications. With an operating temperature of -40°C to +105°C, System 100 components are extensively used in surface and submarine vessels, rail and mass transport solutions.

These components are resistant to a range of fuels, oils and greases. Components are designed to provide environmental sealing, strain relief and flexibility. Their zero halogen and LFH characteristics ensure a low toxicity index, low smoke emission and low corrosive gas evolution.

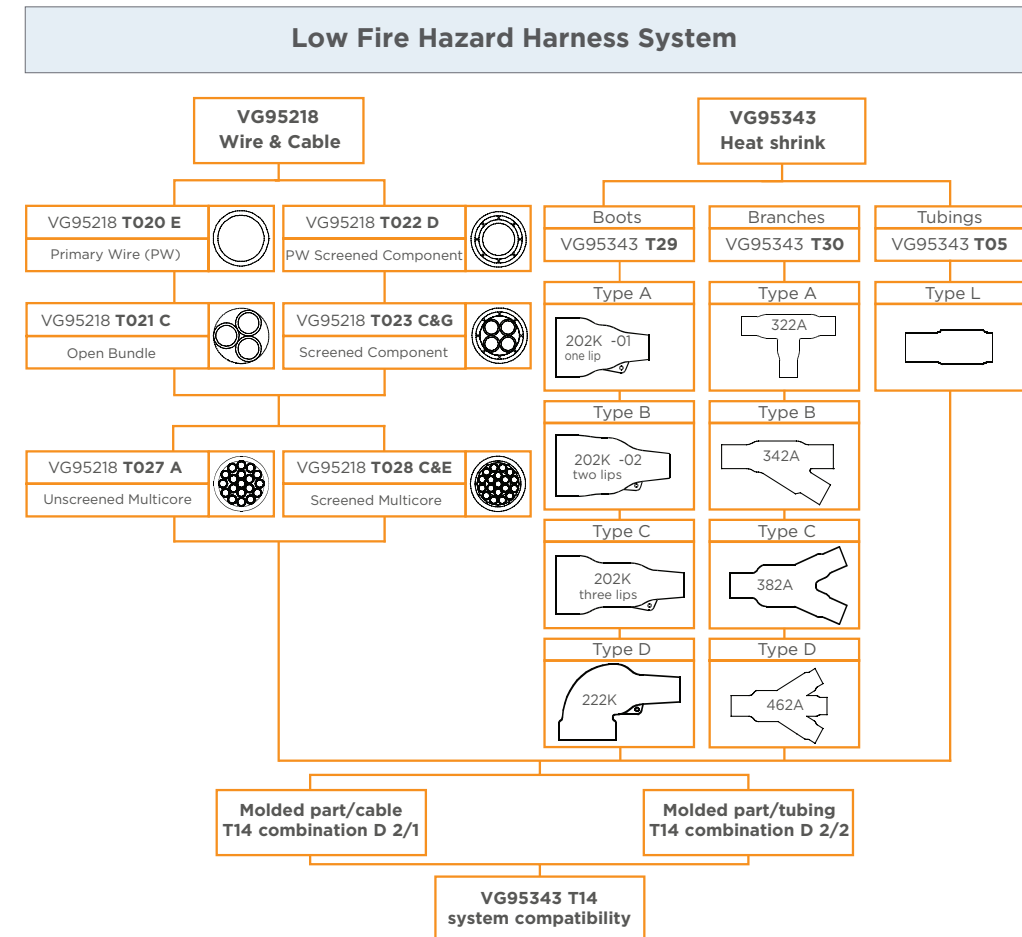

TE's system 200 has an operation temperature of -55 to +200° C and was designed for applications where continuous fluid immersion at high temperatures are required, such as military fuels, oils, and greases. Other benefits of the system include environmental sealing, flexibility and high flame-retardance. RW-200-E heat-shrink tubing, -12 material heat-shrink molded parts, and VG 95218 Part 21 Type A wire are part of the system 200 product portfolio.

Introduction

TE provides wire and cable solutions for challenging environments and demanding applications, whilst meeting a number of global military specifications. This section outlines the portfolio of Raychem wire and cable products that carries a certificate of approval for VG95218 types.

The product range includes

- **VG 95218 Part 20 Type A** Single Core Insulated Wire
- **VG 95218 Part 20 Type E** Single Core Insulated Wire
- **VG 95218 Part 20 Type G** Single Core Insulated Wire
- **VG 95218 Part 21 Type A** Multi Core Insulated Wire (Twisted Pair)
- **VG 95218 Part 21 Type C** Multi Core Insulated Wire (Twisted Pair / Triple / Quad Cable)
- **VG 95218 Part 21 Type E** Multi Core Insulated Wire (Twisted Pair / Triple / Quad Cable)
- **VG 95218 Part 22 Type C** Single Core Insulated Wire, Shielded & Jacketed
- **VG 95218 Part 22 Type D** Single Core Insulated Wire, Shielded & Jacketed
- **VG 95218 Part 23 Type C** Multi Core Insulated Wire, Twisted Pair / Triple / Quad / Heptad, Shielded & Jacketed Cable
- **VG 95218 Part 23 Type F** Multi Core Insulated Wire, Twisted Pair / Triple / Quad / Pentad / Hexad, Shielded & Jacketed Cable
- **VG 95218 Part 24 Type K** Single Core Insulated Wire
- **VG 95218 Part 25 Type G** Single Core Insulated Wire
- **VG 95218 Part 27 Type A** Multi Core, Primary Wires, Jacketed Cable
- **VG 95218 Part 27 Type B** Multi Core, Various components, Jacketed Cable
- **VG 95218 Part 28 Type A** Multi Core, Primary Wires / Twisted Pairs / Shielded & Jacketed Twisted Triples / Various components, Double Overall Shielded & Jacketed Cable
- **VG 95218 Part 28 Type B** Multi Core, Various components, Triple Overall Shielded & Jacketed Cable
- **VG 95218 Part 28 Type C** (LMGSGO) – Multi Core, Primary Wires, Overall Shielded & Jacketed Cable
(LFMSGGO) – Multi Core, Twisted Pairs, Overall Shielded & Jacketed Cable
(FMMSGGO) – Multi Core, Shielded & Wrapped Twisted Pairs, Overall Shielded & Jacketed Cable
(FMMSGGO) – Multi Core, Twisted Pairs or Quads, Overall Shielded & Jacketed Cable
(LFMSGGO) – Multi Core, Shielded & Wrapped Twisted Pairs/Quads, Overall Shielded & Jacketed Cable
Multi Core, Primary Wires / Twisted Pair / Various Components, Overall Shielded & Jacketed Cable
- **VG 95218 Part 28 Type D** Multi Core, Primary Wires / Twisted Pairs / Screened Jacketed Twisted Pairs / Various components, Overall Shielded & Jacketed Cable
- **VG 95218 Part 28 Type E** (LFMSGSSGO) – Multi Core, Twisted Pairs, Double Overall Shielded & Jacketed Cable
(LFMSGSSGO) – Multi Core, Shielded Wrapped Twisted Triples, Double Overall Shielded & Jacketed Cable
Multi Core, Various components, Overall Double Shielded & Jacketed Cable

VG 95218 Part 20 Type A



VG 95218 T020 A - Single Core Insulated Wire

- **Construction:** Dual-wall construction
- **Conductor:** Stranded tin-coated copper
- **Insulation:** Polyalkene (Primary), PVDF (Primary jacket)
- **Temperature Rating:** -55°C to +150°C
- **Voltage Rating:** 600V AC / 900V DC

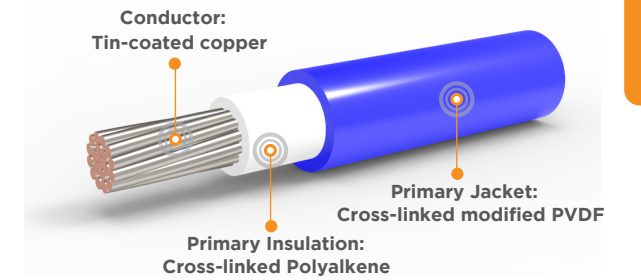

Applications

Raychem wire fully approved VG 95218 T020 Type A has a dual-wall construction which combines the outstanding physical and electrical characteristics of radiation crosslinked Polyalkene, with the excellent mechanical and chemical properties of radiation cross-linked polyvinylidene fluoride (PVDF).

Product Information Table

Part Description	Nominal Cross Sectional Area (mm ²)	Wire Size Code (VG Dash No.)	CONDUCTOR			FINISHED WIRE					Nato Stock Number (NSN) 6145-12-	MTV Part Number 6145-005-
			Stranding No. / Diameter (mm)	Diameter (mm)		Max. Resistance @ 20°C (Ohms/km)	Diameter (mm)			Max. Weight (kg/km)		
Min.	Max.	Lower Spec Limit		Target	Upper Spec Limit							
VG95218T020A016	0.25	16	19/0.127	0.58	0.61	86.00	1.003	1.016	1.041	2.99	165-2230	A016
VG95218T020A001	0.40	01	19/0.16	0.74	0.76	53.10	1.168	1.194	1.219	4.40	164-8663	A001
VG95218T020A002	0.50	02	37/0.127	0.83	0.86	42.30	1.270	1.295	1.320	5.47	306-2456	A002
VG95218T020A003	0.60	03	37/0.14	0.93	0.96	33.50	1.372	1.397	1.422	6.60	181-1850	A003
VG95218T020A004	0.75	04	37/0.16	1.03	1.08	26.60	1.499	1.524	1.549	8.25	187-8108	A004
VG95218T020A005	1.00	05	37/0.18	1.18	1.23	21.00	1.651	1.676	1.702	10.29	187-6676	A005
VG95218T020A006	1.20	06	37/0.20	1.34	1.37	16.40	1.829	1.854	1.880	12.84	187-6677	A006
VG95218T020A007	1.50	07	37/0.23	1.49	1.53	13.50	2.032	2.057	2.083	15.85	187-8109	A007
VG95218T020A008	2.50	08	37/0.287	1.85	1.89	8.20	2.489	2.540	2.591	24.08	187-8110	A008
VG95218T020A017	3.00	17	37/0.32	2.13	2.16	6.63	2.692	2.743	2.794	30.09	185-3573	A017
VG95218T020A009	4.00	09	7X33X0.16#	2.65	3.00	5.09	4.520	4.595	4.670	58.00	199-4671	A009
VG95218T020A010	6.00	10	7X27X0.21#	3.35	3.80	3.39	5.000	5.150	5.500	79.00	307-4348	A010
VG95218T020A011	10.00	11	19X17X0.21#	4.30	4.80	1.95	6.071	6.147	6.223	124.00	188-2429	A011
VG95218T020A012	16.00	12	19X27X0.21#	5.20	5.80	1.24	7.010	7.061	7.112	188.00	307-4349	N/A

NOTES:

- Jacket marking - Not required as standard, available upon request.
- Values are for guidance only, refer to drawings for maintained product information.
- # Indicates conductor stranding diameter shall be Maximum, otherwise shall be nominal.
- VG descriptions in table refer to White Jacket. For other colors, see reference below.
- Nato Stock Numbers (NSN)/MTV apply to white wire only.

TABLE COLOR KEY:

- System 25
- System 100
- System 200

VG Part Description

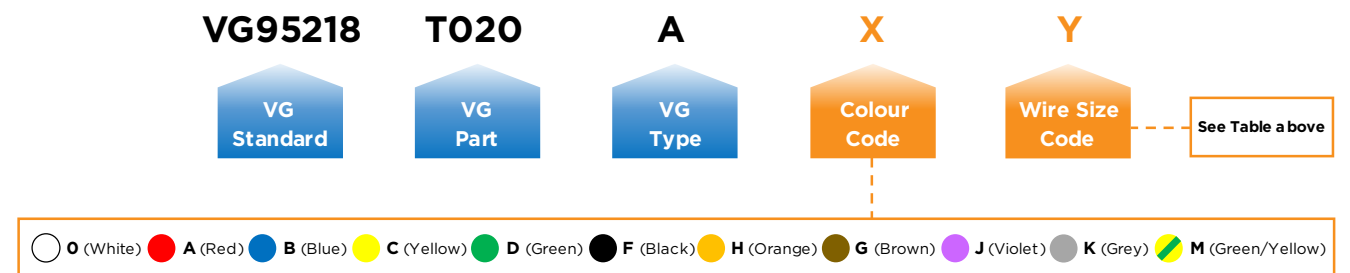

Examples:

- VG95218T020A001 : 0.40mm² conductor, White jacket, for alternative primary jacket color, use color code table above
- VG95218T020AH01 : 0.40mm² conductor, Orange jacket

VG 95218 Part 20 Type E

VG 95218 T020 E - Single Core Insulated Wire

- **Construction:** Dual-wall construction
- **Conductor:** Stranded tin-coated copper
- **Insulation:** Halogen Free Polymer (Primary & Primary jacket)
- **Temperature Rating:** -55°C to +105°C
- **Voltage Rating:** 600V AC / 900V DC

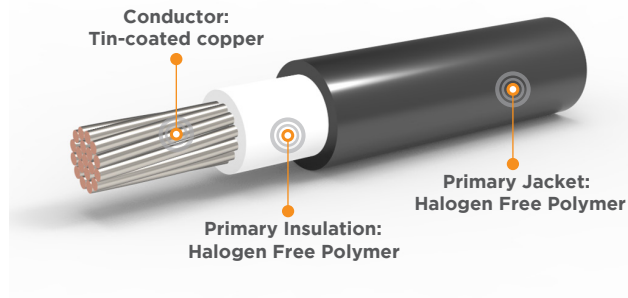

System 100 Halogen Free 600V AC -55°C to +105°C

Applications

Raychem wire fully approved VG 95218 T020 Type E has a dual-wall insulated construction formulated using Halogen Free polymer blends. Developed to meet the VG specification whilst maintaining desirable features of small size, lightweight, excellent handling, flexibility and fluid resistance properties. Meets toxicity, smoke density, halogen free, corrosivity and flame retardant requirements of the VG specification.

Product Information Table

Part Description	Nominal Cross Sectional Area (mm ²)	Wire Size Code (VG Dash No.)	CONDUCTOR			Maxi. Resistance @ 20°C (Ohms/km)	FINISHED WIRE			Max. Weight (kg/km)
			Stranding No. / Diameter (mm)	Diameter (mm)			Diameter (mm)			
				Min.	Max.		Lower Spec Limit	Target	Upper Spec Limit	
VG95218T020E12*	0.15	12	19/0.10	0.45	0.55	135.00	0.98	1.03	1.08	2.59
VG95218T020E01*	0.25	01	19/0.13	0.55	0.66	84.40	1.09	1.14	1.19	3.59
VG95218T020E02*	0.40	02	19/0.16	0.73	0.84	50.50	1.28	1.33	1.38	5.18
VG95218T020E03*	0.50	03	19/0.18	0.82	0.94	40.10	1.37	1.40	1.45	6.60
VG95218T020E04*	0.60	04	19/0.20	0.95	1.04	31.10	1.47	1.52	1.57	7.40
VG95218T020E05*	0.75	05	19/0.23	1.04	1.20	26.70	1.59	1.60	1.65	8.90
VG95218T020E06*	1.00	06	19/0.25	1.17	1.32	20.00	1.69	1.75	1.80	10.70
VG95218T020E07*	1.20	07	19/0.29	1.32	1.47	15.30	1.88	1.93	1.98	13.60
VG95218T020E08*	1.50	08	37/0.23	1.46	1.68	13.70	2.03	2.08	2.13	16.00
VG95218T020E09*	2.00	09	37/0.25	1.68	1.87	10.50	2.31	2.36	2.41	20.30
VG95218T020E10*	2.50	10	37/0.29	1.85	2.14	8.21	2.50	2.55	2.63	25.70
VG95218T020E11*	3.00	11	37/0.32	2.12	2.29	6.58	2.70	2.78	2.86	31.00

NOTES:

- * VG Part Description to be completed using color code below to determine color of Primary Jacket.
- Jacket marking - Not required as standard, available upon request.
- Values are for guidance only, refer to drawings for maintained product information.

TABLE COLOR KEY:

System 25 System 100 System 200

VG Part Description

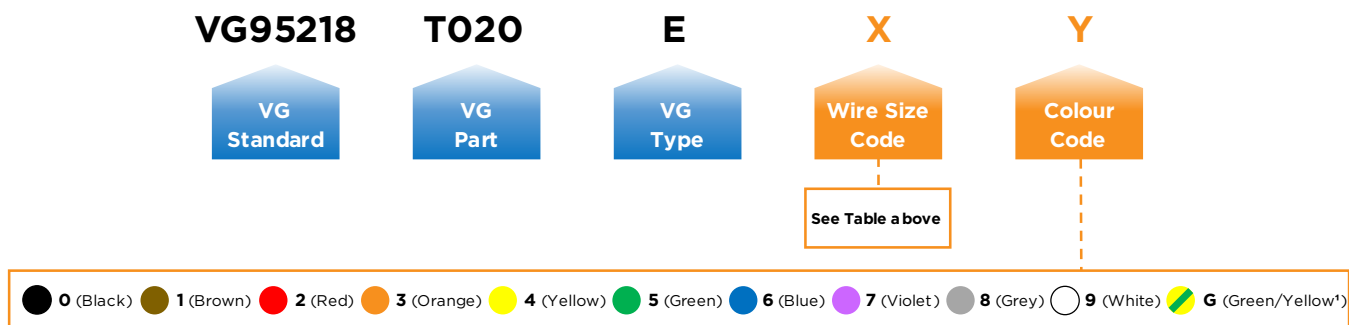

¹ Note: Green & Yellow striped wire to have 70% maximum yellow base and 30% minimum green stripe.

Examples:

- VG95218T020E029 : 0.40mm² conductor, White jacket,
- VG95218T020E023 : 0.40mm² conductor, Orange jacket

VG 95218 Part 20 Type G

VG 95218 T020 G - Single Core Insulated Wire

- **Construction:** Single wall construction
- **Conductor:** Stranded tin-coated copper
mm² = IEC 228 Class 6
AWG = Flexible, rope stranded
- **Insulation:** Fire Retardant Flexible Polyolefin (Thermorad)
- **Temperature Rating:** -40°C to +150°C
- **Voltage Rating:** 600V AC / 900V DC

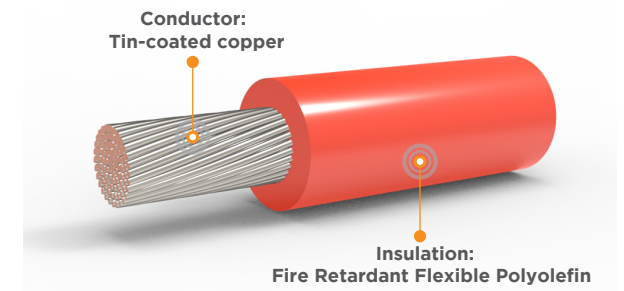

System 25 Thermorad 600V AC -40°C to +150°C

Applications

Raychem wire fully approved VG 95218 T020 Type G has a single-wall construction. Developed as a general purpose wire which is unaffected by most common chemicals and solvents. Flexible, highly flame retardant and has an overall balance of physical and chemical properties.

Product Information Table

Part Description	Cable Size (mm ²)/AWG		Wire Size Code (VG Dash No.)	CONDUCTOR				Max. Resistance @ 20°C (Ohms/km)	Min. Wall (mm)	FINISHED WIRE			Max. Weight (kg/km)
	mm ²	AWG		Number of Strands	Max. Strand Diameter (mm)	Diameter (mm)				Diameter (mm)			
						Min.	Max.			Lower Spec Limit	Target	Upper Spec Limit	
VG95218T020G10*	1.5	-	10	85	0.16	1.40	1.70	13.70	0.55	2.80	3.00	3.20	24
VG95218T020G11*	2.5	-	11	7x20	0.16	2.20	2.60	8.21	0.57	3.70	3.90	4.10	36
VG95218T020G01*	4.0	-	01	7x33	0.16	2.60	3.00	5.09	0.62	4.25	4.50	4.75	58
VG95218T020G02*	6.0	-	02	7x27	0.21	3.30	3.80	3.39	0.62	4.95	5.20	5.45	77
VG95218T020G12*	-	8	12	19x35	0.13	3.90	4.40	2.30	0.54	5.35	5.65	5.95	100
VG95218T020G03*	10	-	03	19x17	0.21	4.30	4.80	1.95	0.63	5.90	6.20	6.50	122
VG95218T020G04*	16	-	04	19x27	0.21	5.20	5.80	1.24	0.75	7.10	7.40	7.70	187
VG95218T020G05*	25	-	05	37x21	0.21	6.90	7.70	0.795	0.80	9.00	9.30	9.60	275
VG95218T020G06*	35	-	06	37x30	0.21	8.10	9.00	0.565	0.82	10.30	10.60	10.90	389
VG95218T020G07*	50	-	07	37x19	0.31	9.60	10.70	0.393	0.93	12.10	12.45	12.80	542
VG95218T020G08*	70	-	08	37x27	0.31	11.40	12.60	0.277	1.03	14.20	14.55	14.90	780
VG95218T020G09*	95	-	09	37x36	0.31	13.30	14.80	0.210	1.23	16.60	17.00	17.40	1020
VG95218T020G14*	120	-	14	37x46	0.31	15.00	17.50	0.165	1.40	18.70	19.40	20.20	1420

NOTES:

- * VG Part Description to be completed using color code below to determine color of Insulation.
- Insulation marking - The mark shall be: **Raychem - VG95218T020G### - K1010** where: "###" = Wire Size Code + Color Code
e.g: Size 2.5mm² with black insulation shall be marked: **Raychem - VG95218T020G110 - K1010**
- Values are for guidance only, refer to drawings for maintained product information.

TABLE COLOR KEY:

System 25 System 100 System 200

VG Part Description

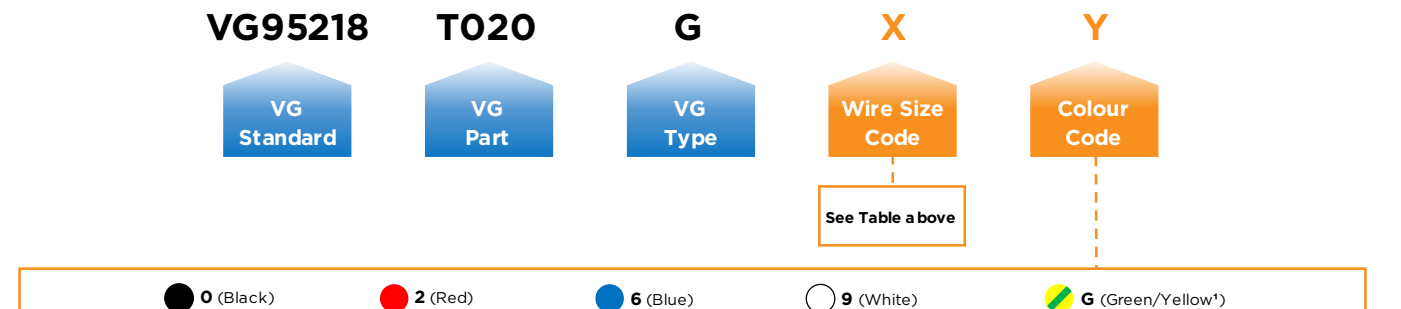

¹ Note: Green & Yellow striped wire to have 70% maximum yellow base and 30% minimum green stripe.

Examples:

- VG95218T020G119 : 2.5mm² conductor, White jacket,
- VG95218T020G116 : 2.5mm² conductor, Blue jacket

VG 95218 Part 21 Type A



VG 95218 T021 A - Multi Core Primary Wire (Twisted Pair)

- Construction:** 2 x M22759/44 single elements, twisted
- Conductor:** Stranded silver-coated copper
- Insulation:** Single wall, Modified ethylene tetrafluoroethylene (ETFE)
- Temperature Rating:** -55°C to +200°C
- Voltage Rating:** 600V AC / 600V DC

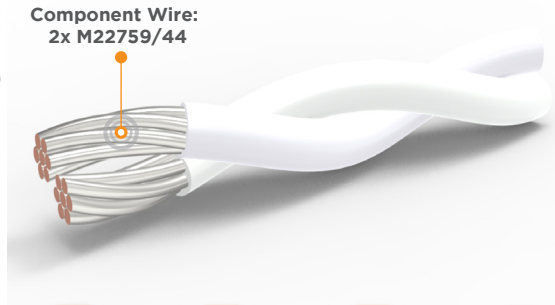

System 200 ETFE 600V AC -55°C +200°C

Applications

Raychem cable fully approved VG 95218 T021 Type A is a two core multi core cable containing two twisted M22759/44 single wire elements (Approved to SAE AS22759/44). M22759/44 wire is insulated with a modified radiation crosslinked ETFE polymer. Combining easy handling of a flexible thin wall wire, with excellent scrape abrasion, cut-through characteristics and rated to high operating temperatures of up to 200°C. Offering excellent electrical arc tracking resistance and exceptional chemical resistance in a small size, ultra lightweight product.

Product Information Table

Part Description	Nominal Conductor Cross Sectional (AWG)	Wire Size Code (VG Dash No.)	Component Wire Description	Max. Resistance @ 20°C (Ohms/km)	FINISHED CABLE			
					Diameter (mm)		Max. Weight (kg/km)	Nato Stock Number 6145-12-325-
					Nom.	Max.		
VG95218T021A001	28	001	M22759/44-28-9	219.8	1.37	1.47	2.75	9693
VG95218T021A002	26	002	M22759/44-26-9	132.3	1.63	1.73	4.23	9694
VG95218T021A003	24	003	M22759/44-24-9	83.8	1.88	1.98	6.04	9695
VG95218T021A004	22	004	M22759/44-22-9	52.1	2.18	2.29	8.46	9696
VG95218T021A005	20	005	M22759/44-20-9	31.7	2.54	2.64	12.99	9697
VG95218T021A006	18	006	M22759/44-18-9	20.0	3.05	3.15	19.63	9698
VG95218T021A007	16	007	M22759/44-16-9	15.6	3.45	3.56	25.07	9699

NOTES:

- VG descriptions in table are only available in white color.
- Components for the above cables shall be M22759/44-XX-9, Where XX = Conductor size (AWG), 9 = Component color white e.g. Components for VG95218T021A007 shall be M22759/44-16-9
- Values are for guidance only, refer to drawings for maintained product information.

TABLE COLOR KEY:

System 25 (Yellow)
System 100 (Blue)
System 200 (Orange)

VG Part Description

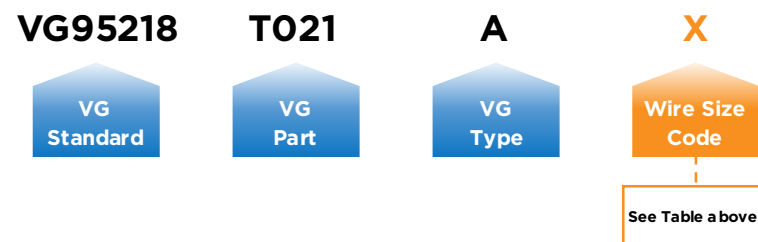

Examples:

- VG95218T021A001 : 2 x 28AWG conductors, White components
- VG95218T021A007 : 2 x 16AWG conductors, White components

VG 95218 Part 21 Type C



VG 95218 T021 C - Multi Core Insulated Wire (Twisted Pair Cable)

- Construction:** 2 x VG95218T020E single elements, twisted
- Conductor:** Stranded tin-coated copper
- Insulation:** Halogen Free Polymer (Primary & Primary jacket)
- Temperature Rating:** -55°C to +105°C
- Voltage Rating:** 600V AC / 900V DC

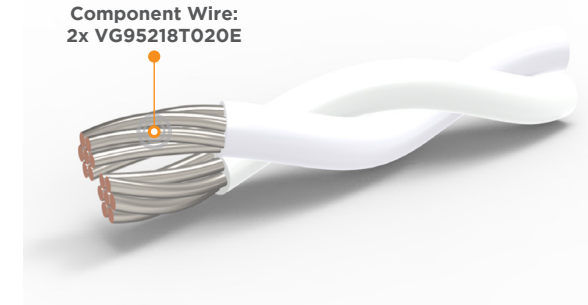

System 100 Halogen Free 600V AC -55°C +105°C

Applications

Raychem cable fully approved VG 95218 T021 Type C is a two core multi core cable containing two twisted VG95218T020E single wire elements. VG 95218 T020 Type E wire has a dual-wall insulated construction formulated using Halogen Free polymer blends. Developed to meet the VG specification whilst maintaining desirable features of small size, lightweight, excellent handling, flexibility and fluid resistance properties. Meets toxicity, smoke density, halogen free, corrosivity and flame retardant requirements of the VG specification.

Product Information Table

Part Description (Non-marked Components)	Part Description (Marked Components)	Nominal Conductor Cross Section (mm²)	Wire Size Code (VG Dash No.)	Component Wire Description	Max. Resistance @ 20°C (Ohms/km)	FINISHED CABLE		
						Diameter (mm)		Max. Weight (kg/km)
						Nom.	Max.	
VG95218T021C034	VG95218T021C134	0.15	34	VG95218T020E129	135.00	2.06	2.16	5.34
VG95218T021C001	VG95218T021C101	0.25	01	VG95218T020E019	85.60	2.29	2.39	7.40
VG95218T021C002	VG95218T021C102	0.40	02	VG95218T020E029	51.50	2.66	2.77	10.70
VG95218T021C003	VG95218T021C103	0.50	03	VG95218T020E039	40.90	2.82	2.90	13.60
VG95218T021C004	VG95218T021C104	0.60	04	VG95218T020E049	31.70	3.04	3.14	15.20
VG95218T021C005	VG95218T021C105	0.75	05	VG95218T020E059	27.20	3.24	3.29	18.30
VG95218T021C006	VG95218T021C106	1.00	06	VG95218T020E069	20.40	3.49	3.59	22.00
VG95218T021C007	VG95218T021C107	1.20	07	VG95218T020E079	15.60	3.86	3.96	28.00
VG95218T021C008	n/a	1.50	08	VG95218T020E089	14.00	4.16	4.26	32.90
VG95218T021C009	n/a	2.00	09	VG95218T020E099	10.70	4.72	4.82	41.80
VG95218T021C010	n/a	2.50	10	VG95218T020E109	8.37	5.13	5.26	52.90
VG95218T021C011	n/a	3.00	11	VG95218T020E119	6.71	5.56	5.71	63.90

NOTES:

- VG descriptions in table are only available in white color.
- Core number marking is available on sizes 0.15mm² to 1.20mm². Cores shall be marked "1" & "2" as per VG 95218-2 Clause 5.1.2.2.
- Components for the above cables shall be as listed under "Component Wire Description" column. e.g. Components for VG95218T021C034/134 shall be VG95218T020E129.
- Values are for guidance only, refer to drawings for maintained product information.

TABLE COLOR KEY:

System 25 (Yellow)
System 100 (Blue)
System 200 (Orange)

VG Part Description

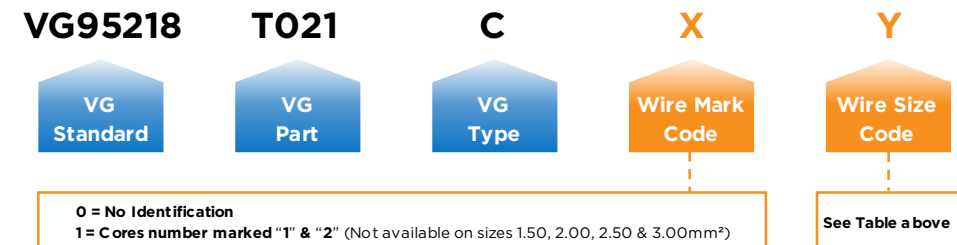

Examples:

- VG95218T021C034 : 2 x 0.15mm² conductors, White components
- VG95218T021C134 : 2 x 0.15mm² conductors, White & Number marked components

VG 95218 Part 21 Type C

VG 95218 T021 C - Multi Core Insulated Wire (Twisted Triple Cable)

- **Construction:** 3 x VG95218T020E single elements, twisted
- **Conductor:** Stranded tin-coated copper
- **Insulation:** Halogen Free Polymer (Primary & Primary jacket)
- **Temperature Rating:** -55°C to +105°C
- **Voltage Rating:** 600V AC / 900V DC

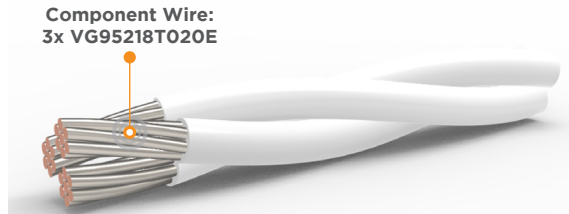

System 100 Halogen Free 600V AC -55°C +105°C

Applications

Raychem cable fully approved VG 95218 T021 Type C is a three core multi core cable containing three twisted VG95218T020E single wire elements. VG 95218 T020 Type E wire has a dual-wall insulated construction formulated using Halogen Free polymer blends. Developed to meet the VG specification whilst maintaining desirable features of small size, lightweight, excellent handling, flexibility and fluid resistance properties. Meets toxicity, smoke density, halogen free, corrosivity and flame retardant requirements of the VG specification.

Product Information Table

Part Description (Non-marked Components)	Part Description (Marked Components)	Nominal Conductor Cross Section (mm ²)	Wire Size Code (VG Dash No.)	Component Wire Description	Max. Resistance @ 20°C (Ohms/km)	FINISHED CABLE		
						Diameter (mm)		Max. Weight (kg/km)
						Nom.	Max.	
VG95218T021C035	VG95218T021C135	0.15	35	VG95218T020E129	135.00	2.22	2.33	8.01
VG95218T021C012	VG95218T021C112	0.25	12	VG95218T020E019	85.60	2.47	2.58	11.10
VG95218T021C013	VG95218T021C113	0.40	13	VG95218T020E029	51.50	2.88	2.99	16.00
VG95218T021C014	VG95218T021C114	0.50	14	VG95218T020E039	40.90	3.05	3.13	20.40
VG95218T021C015	VG95218T021C115	0.60	15	VG95218T020E049	31.70	3.28	3.39	22.90
VG95218T021C016	VG95218T021C116	0.75	16	VG95218T020E059	27.20	3.49	3.55	27.50
VG95218T021C017	VG95218T021C117	1.00	17	VG95218T020E069	20.40	3.77	3.88	33.10
VG95218T021C018	VG95218T021C118	1.20	18	VG95218T020E079	15.60	4.17	4.28	42.00
VG95218T021C019	n/a	1.50	19	VG95218T020E089	14.00	4.49	4.60	49.40
VG95218T021C020	n/a	2.00	20	VG95218T020E099	10.70	5.10	5.21	62.70
VG95218T021C021	n/a	2.50	21	VG95218T020E109	8.37	5.54	5.68	79.30
VG95218T021C022	n/a	3.00	22	VG95218T020E119	6.71	6.00	6.17	95.80

NOTES:

- VG descriptions in table are only available in white color.
- Core number marking is available on sizes 0.15mm² to 1.20mm². Cores shall be marked "1", "2" & "3" as per VG 95218-2 Clause 5.1.2.2.
- Components for the above cables shall be as listed under "Component wire description" column. e.g. Components for VG95218T021C035/135 shall be VG95218T020E129.
- Values are for guidance only, refer to drawings for maintained product information.

TABLE COLOR KEY:

System 25 System 100 System 200

VG Part Description

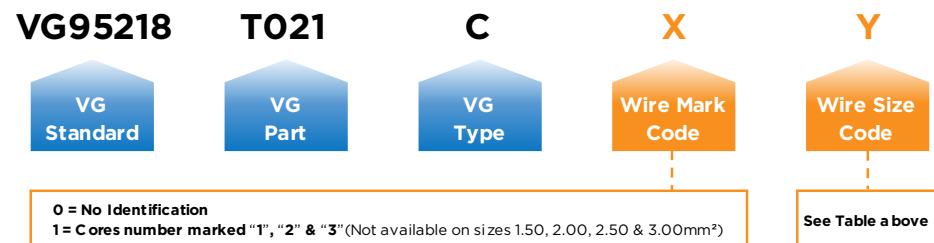

Examples:

- VG95218T021C035 : 3 x 0.15mm² conductors, White components
- VG95218T021C135 : 3 x 0.15mm² conductors, White & Number marked components

VG 95218 Part 21 Type C

VG 95218 T021 C - Multi Core Insulated Wire (Twisted Quad Cable)

- **Construction:** 4 x VG95218T020E single elements, twisted
- **Conductor:** Stranded tin-coated copper
- **Insulation:** Halogen Free Polymer (Primary & Primary jacket)
- **Temperature Rating:** -55°C to +105°C
- **Voltage Rating:** 600V AC / 900V DC

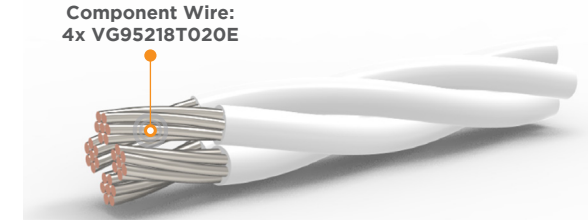

System 100 Halogen Free 600V AC -55°C +105°C

Applications

Raychem cable fully approved VG 95218 T021 Type C is a four core multi core cable containing four twisted VG95218T020E single wire elements. VG 95218 T020 Type E wire has a dual-wall insulated construction formulated using Halogen Free polymer blends. Developed to meet the VG specification whilst maintaining desirable features of small size, lightweight, excellent handling, flexibility and fluid resistance properties. Meets toxicity, smoke density, halogen free, corrosivity and flame retardant requirements of the VG specification.

Product Information Table

Part Description (Non-marked Components)	Part Description (Marked Components)	Nominal Conductor Cross Section (mm ²)	Wire Size Code (VG Dash No.)	Component Wire Description	Max. Resistance @ 20°C (Ohms/km)	FINISHED CABLE		
						Diameter (mm)		Max. Weight (kg/km)
						Nom.	Max.	
VG95218T021C036	VG95218T021C136	0.15	36	VG95218T020E129	135.00	2.48	2.60	10.70
VG95218T021C023	VG95218T021C123	0.25	23	VG95218T020E019	85.60	2.76	2.88	14.80
VG95218T021C024	VG95218T021C124	0.40	24	VG95218T020E029	51.50	3.21	3.33	21.30
VG95218T021C025	VG95218T021C125	0.50	25	VG95218T020E039	40.90	3.40	3.50	27.20
VG95218T021C026	VG95218T021C126	0.60	26	VG95218T020E049	31.70	3.66	3.79	30.50
VG95218T021C027	VG95218T021C127	0.75	27	VG95218T020E059	27.20	3.90	3.97	36.70
VG95218T021C028	VG95218T021C128	1.00	28	VG95218T020E069	20.40	4.21	4.33	44.10
VG95218T021C029	VG95218T021C129	1.20	29	VG95218T020E079	15.60	4.65	4.77	56.00
VG95218T021C030	n/a	1.50	30	VG95218T020E089	14.00	5.01	5.14	65.80
VG95218T021C031	n/a	2.00	31	VG95218T020E099	10.70	5.69	5.81	83.60
VG95218T021C032	n/a	2.50	32	VG95218T020E109	8.37	6.18	6.34	106.00
VG95218T021C033	n/a	3.00	33	VG95218T020E119	6.71	6.70	6.88	128.00

NOTES:

- VG descriptions in table are only available in white color.
- Core number marking is available on sizes 0.15mm² to 1.20mm². Cores shall be marked "1", "2", "3" & "4" as per VG 95218-2 Clause 5.1.2.2.
- Components for the above cables shall be as listed under "Component wire description" column. e.g. Components for VG95218T021C036/136 shall be VG95218T020E129.
- Values are for guidance only, refer to drawings for maintained product information.

TABLE COLOR KEY:

System 25 System 100 System 200

VG Part Description

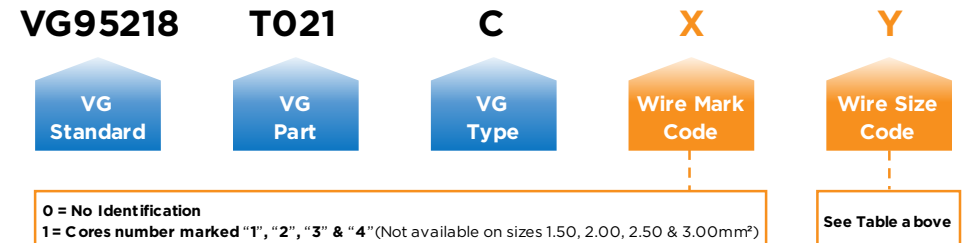

Examples:

- VG95218T021C036 : 4 x 0.15mm² conductors, White components
- VG95218T021C136 : 4 x 0.15mm² conductors, White & Number marked components

VG 95218 Part 21 Type E



VG 95218 T021 E - Multi Core Insulated Wire (Twisted Pair Cable)

- **Construction:** 2 x VG95218T020A single elements, twisted
- **Conductor:** Stranded tin-coated copper
- **Insulation:** Polyalkene (Primary), PVDF (Primary jacket)
- **Temperature Rating:** -55°C to +150°C
- **Voltage Rating:** 600V AC / 900V DC

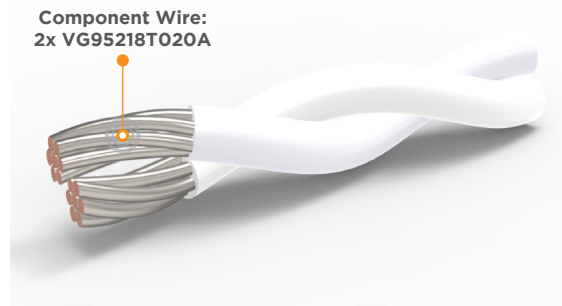

Applications

Raychem cable fully approved VG 95218 T021 Type E is a two core multi core cable containing two twisted VG95218T020A single wire elements. VG95218T020A wire has a dual-wall construction which combines the outstanding physical and electrical characteristics of radiation crosslinked Polyalkene, with the excellent mechanical and chemical properties of radiation cross-linked polyvinylidene fluoride (PVDF).

Product Information Table

Part Description	Nominal Conductor Cross Section (mm ²)	Wire Size Code (VG Dash No.)	Component Wire Description	Max. Resistance @ 20°C (Ohms/km)	FINISHED CABLE				
					Diameter (mm)		Max. Weight (kg/km)	Nato Stock Number 6145-12-	MTV Part Number 6145-005-
					Nom.	Max.			
VG95218T021E010	0.25	010	VG95218T020A016	87.70	2.03	2.13	6.80	311-5879	E010
VG95218T021E001	0.40	001	VG95218T020A001	54.20	2.39	2.48	9.60	188-8970	E001
VG95218T021E002	0.60	002	VG95218T020A003	34.20	2.79	2.90	14.10	188-8967	E002
VG95218T021E003	1.20	003	VG95218T020A006	16.70	3.71	3.80	27.20	188-8732	E003

- NOTES:**
- VG descriptions in table are only available in white color.
 - Components for the above cables shall be as listed under "Component Wire Description" column. e.g. Components for VG95218T021E010 shall be VG95218T020A016.
 - Values are for guidance only, refer to drawings for maintained product information.

TABLE COLOR KEY:

System 25
System 100
System 200

VG Part Description

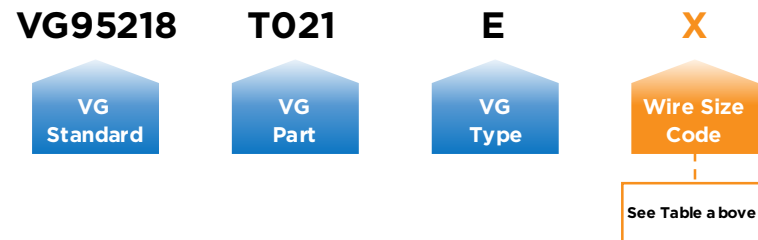

Examples:
 VG95218T021E010 : 2 x 0.25mm² conductors, White components
 VG95218T021E003 : 2 x 1.20mm² conductors, White components

VG 95218 Part 21 Type E



VG 95218 T021 E - Multi Core Insulated Wire (Twisted Triple Cable)

- **Construction:** 3 x VG95218T020A single elements, twisted
- **Conductor:** Stranded tin-coated copper
- **Insulation:** Polyalkene (Primary), PVDF (Primary jacket)
- **Temperature Rating:** -55°C to +150°C
- **Voltage Rating:** 600V AC / 900V DC



Applications

Raychem cable fully approved VG 95218 T021 Type E is a three core multi core cable containing three twisted VG95218T020A single wire elements. VG95218T020A wire has a dual-wall construction which combines the outstanding physical and electrical characteristics of radiation crosslinked Polyalkene, with the excellent mechanical and chemical properties of radiation cross-linked polyvinylidene fluoride (PVDF).

Product Information Table

Part Description	Nominal Conductor Cross Section (mm ²)	Wire Size Code (VG Dash No.)	Component Wire Description	Max. Resistance @ 20°C (Ohms/km)	FINISHED CABLE				
					Diameter (mm)		Max. Weight (kg/km)	Nato Stock Number 6145-12-	MTV Part Number 6145-005-
					Nom.	Max.			
VG95218T021E006	0.25	006	VG95218T020A016	87.70	2.19	2.30	9.70	322-4437	E006
VG95218T021E004	0.40	004	VG95218T020A001	54.20	2.58	2.68	14.40	188-8971	E004
VG95218T021E005	0.60	005	VG95218T020A003	34.20	3.02	3.13	21.20	189-0588	E005
VG95218T021E011	1.20	011	VG95218T020A006	16.70	4.00	4.20	40.70	N/A	N/A

- NOTES:**
- VG descriptions in table are only available in white color.
 - Components for the above cables shall be as listed under "Component Wire Description" column. e.g. Components for VG95218T021E006 shall be VG95218T020A016.
 - Values are for guidance only, refer to drawings for maintained product information.

TABLE COLOR KEY:

System 25
System 100
System 200

VG Part Description

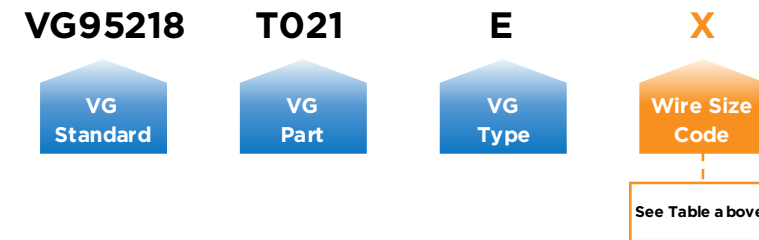

Examples:
 VG95218T021E006 : 3 x 0.25mm² conductors, White components
 VG95218T021E011 : 3 x 1.20mm² conductors, White components

VG 95218 Part 21 Type E



VG 95218 T021 E - Multi Core Insulated Wire (Twisted Quad Cable)

- **Construction:** 4 x VG95218T020A single elements, twisted.
- **Conductor:** Stranded tin-coated copper
- **Insulation:** Polyalkene (Primary), PVDF (Primary jacket)
- **Temperature Rating:** -55°C to +150°C
- **Voltage Rating:** 600V AC / 900V DC

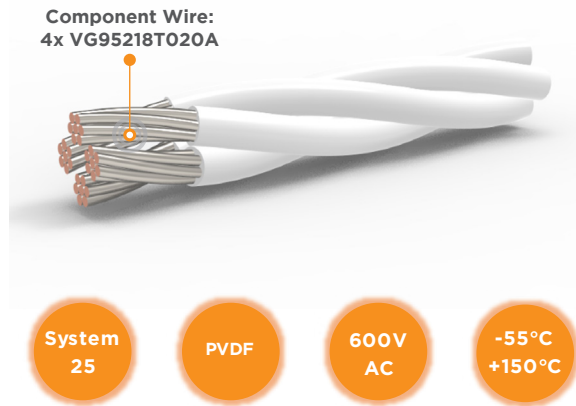

Applications

Raychem cable fully approved VG 95218 T021 Type E is a four core multi core cable containing four twisted VG95218T020A single wire elements. VG95218T020A wire has a dual-wall construction which combines the outstanding physical and electrical characteristics of radiation crosslinked Polyalkene, with the excellent mechanical and chemical properties of radiation cross-linked polyvinylidene fluoride (PVDF).

Product Information Table

Part Description	Nominal Conductor Cross Section (mm ²)	Wire Size Code (VG Dash No.)	Component Wire Description	Max. Resistance @ 20°C (Ohms/km)	FINISHED CABLE				
					Diameter (mm)		Max. Weight (kg/km)	Nato Stock Number 6145-12-	MTV Part Number 6145-005-
					Nom.	Max.			
VG95218T021E009	0.25	009	VG95218T020A016	87.70	2.45	2.57	13.00	N/A	E009
VG95218T021E007	0.40	007	VG95218T020A001	54.20	2.88	2.99	19.20	300-2086	E007
VG95218T021E008	0.60	008	VG95218T020A003	34.20	3.37	3.49	28.20	319-2109	E008

- NOTES:**
- VG descriptions in table are only available in white color.
 - Components for the above cables shall be as listed under "Component Wire Description" column. e.g. Components for VG95218T021E009 shall be VG95218T020A016.
 - Values are for guidance only, refer to drawings for maintained product information.

TABLE COLOR KEY:

System 25
System 100
System 200

VG Part Description

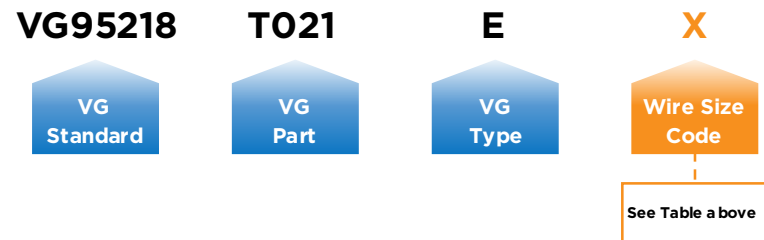

Examples:
 VG95218T021E009 : 4 x 0.25mm² conductors, White components
 VG95218T021E008 : 4 x 0.60mm² conductors, White components

VG 95218 Part 22 Type C



VG 95218 T022 C - Single Core Insulated Wire, Shielded & Jacketed

- **Construction:** Single insulated core (Dual wall) with overall shield and jacket
- **Conductor:** Stranded tin-coated copper
- **Insulation:** Polyalkene (Primary), PVDF (Primary jacket)
- **Shield Material/Type:** Tin-coated copper / Optimized Woven Shield
- **Overall Jacket:** PVDF
- **Temperature Rating:** -40°C to +150°C
- **Voltage Rating:** 600V AC / 900V DC

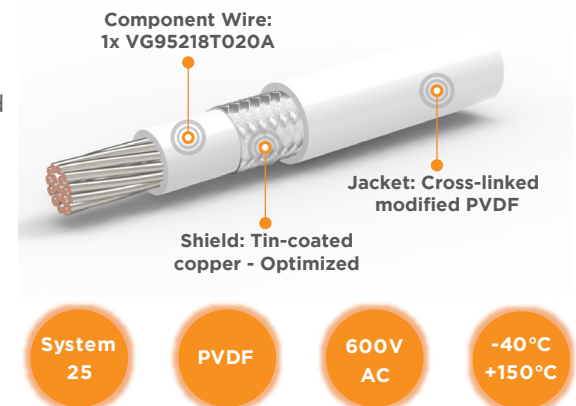

Applications

Raychem cable fully approved VG 95218 T022 Type C is a single core, shielded and jacketed cable containing one VG95218T020A single wire element. VG 95218 T020 Type A wire has a dual-wall construction which combines the outstanding physical and electrical characteristics of radiation crosslinked Polyalkene, with the excellent mechanical and chemical properties of radiation cross-linked polyvinylidene fluoride (PVDF). The woven outer shield is optimized to achieve screening efficiency against sensitive lines or high EMI. The PVDF outer jacket offers increased mechanical and environmental protection properties.

Product Information Table

Part Description	Nominal Conductor Cross Section (mm ²)	Wire Size Code (VG Dash No.)	Component Wire Description	Max. Resistance @ 20°C (Ohms/km)	Shield Size (mm)	FINISHED CABLE						
						Jacket Thickness (mm)		Diameter (mm)			Max. Weight (kg/km)	MTV Part Number 6145-005-
						Min.	Nom.	Lower Spec Limit	Target	Upper Spec Limit		
VG95218T022C016	0.25	016	VG95218T020A016	86.00	0.10	0.13	0.18	1.73	1.83	1.92	8.60	C016
VG95218T022C001	0.40	001	VG95218T020A001	53.10	0.10	0.13	0.18	1.91	2.00	2.10	10.80	C001
VG95218T022C002	0.50	002	VG95218T020A002	42.30	0.10	0.15	0.20	2.04	2.14	2.24	14.10	C002
VG95218T022C003	0.60	003	VG95218T020A003	33.50	0.10	0.15	0.20	2.16	2.25	2.36	14.70	C003
VG95218T022C004	0.75	004	VG95218T020A004	26.60	0.10	0.15	0.20	2.32	2.42	2.52	18.30	C004
VG95218T022C005	1.00	005	VG95218T020A005	21.00	0.13	0.15	0.20	2.54	2.64	2.74	20.70	C005
VG95218T022C006	1.20	006	VG95218T020A006	16.40	0.13	0.15	0.20	2.72	2.81	2.92	24.60	C006
VG95218T022C007	1.50	007	VG95218T020A007	13.50	0.13	0.15	0.20	2.82	3.02	3.15	31.60	C007
VG95218T022C008	2.50	008	VG95218T020A008	8.20	0.13	0.15	0.20	3.31	3.50	3.66	44.50	C008

- NOTES:**
- VG descriptions in table are only available in white color (Insulation & Jacket).
 - Component for the above cables shall be as listed under "Component Wire Description" column. e.g. Component for VG95218T022C016 shall be VG95218T020A016.
 - Values are for guidance only, refer to drawings for maintained product information.

TABLE COLOR KEY:

System 25
System 100
System 200

VG Part Description

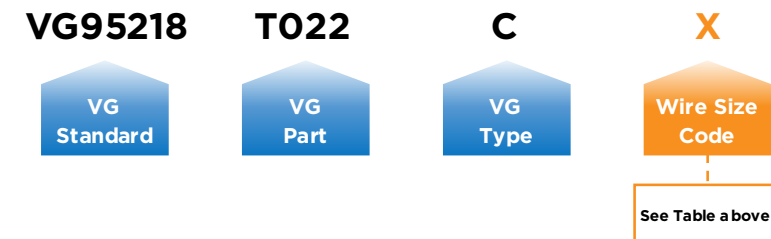

Examples:
 VG95218T022C016 : 1 x 0.25mm² conductor, White component & White Jacket
 VG95218T022C008 : 1 x 2.50mm² conductor, White component & White Jacket

VG 95218 Part 22 Type D

VG 95218 T022 D – Single Core Insulated Wire, Shielded & Jacketed Cable

- **Construction:** Single insulated core (Dual wall) with overall shield and jacket
- **Conductor:** Stranded tin-coated copper
- **Insulation:** Halogen Free Polymer (Primary & Primary jacket)
- **Shield Material/Type:** Tin-coated copper / Optimized Woven Shield
- **Overall Jacket:** Zerohal jacketing material
- **Temperature Rating:** -40°C to +105°C
- **Voltage Rating:** 600V AC / 900V DC

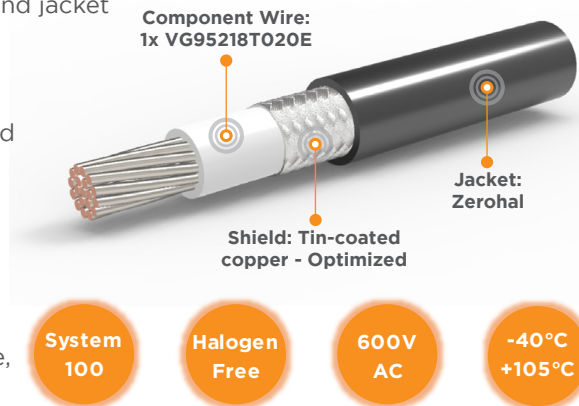

System 100 Halogen Free 600V AC -40°C +105°C

Applications

Raychem cable fully approved VG 95218 T022 Type D is a single core, shielded and jacketed cable containing one VG95218T020E single wire element. VG 95218 T020 Type E wire has a dual-wall insulated construction formulated using Halogen Free polymer blends. Developed to meet the VG specification whilst maintaining desirable features of small size, lightweight, excellent handling, flexibility and fluid resistance properties. The woven outer shield is optimized to achieve screening efficiency against sensitive lines or high EMI. The Zerohal outer jacket offers increased mechanical and environmental protection properties whilst meeting toxicity, smoke density, halogen free, corrosivity and flame retardant requirements of the VG specification.

Product Information Table

Part Description	Nominal Conductor Cross Section (mm ²)	Wire Size Code (VG Dash No.)	Component Wire Description	Max. Resistance @ 20°C (Ohms/km)	Shield Size (mm)	FINISHED CABLE					Max. Weight (kg/km)
						Jacket Thickness (mm)		Diameter (mm)			
						Min.	Nom.	Lower Spec Limit	Target	Upper Spec Limit	
VG95218T022D012	0.15	012	VG95218T020E129	134.00	0.10	0.15	0.28	1.92	2.03	2.14	8.79
VG95218T022D001	0.25	001	VG95218 T020E019	84.40	0.10	0.15	0.28	2.03	2.14	2.25	10.30
VG95218T022D002	0.40	002	VG95218T020E029	50.50	0.10	0.15	0.28	2.23	2.33	2.45	12.80
VG95218T022D003	0.50	003	VG95218T020E039	40.10	0.10	0.15	0.28	2.30	2.40	2.54	14.60
VG95218T022D004	0.60	004	VG95218T020E049	31.10	0.10	0.15	0.28	2.39	2.52	2.65	16.00
VG95218T022D005	0.75	005	VG95218T020E059	26.70	0.10	0.15	0.28	2.52	2.60	2.78	17.90
VG95218T022D006	1.00	006	VG95218T020E069	20.00	0.10	0.15	0.28	2.62	2.75	2.88	20.20
VG95218T022D007	1.20	007	VG95218T020E079	15.30	0.10	0.15	0.28	2.78	2.93	3.08	23.90
VG95218T022D008	1.50	008	VG95218T020E089	13.70	0.13	0.15	0.28	3.05	3.20	3.37	29.30
VG95218T022D009	2.00	009	VG95218T020E099	10.50	0.13	0.15	0.28	3.31	3.48	3.65	34.90
VG95218T022D010	2.50	010	VG95218T020E109	8.21	0.13	0.15	0.28	3.48	3.67	3.86	41.30
VG95218T022D011	3.00	011	VG95218T020E119	6.58	0.13	0.15	0.28	3.71	3.90	4.09	47.90

- NOTES:**
- VG descriptions in table are only available in white insulation & black jacket.
 - Component for the above cables shall be as listed under "Component Wire Description" column. e.g. Component for VG95218T022D012 shall be VG95218T020E129.

TABLE COLOR KEY:

- System 25
- System 100
- System 200

VG Part Description

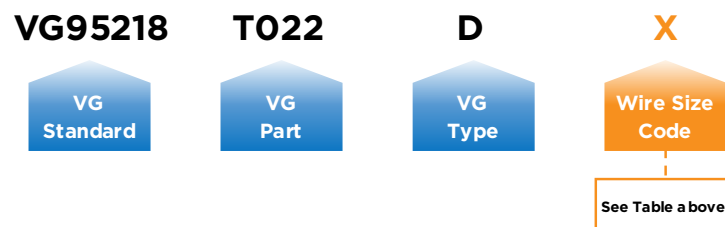

Examples:
 VG95218T022D012 : 1 x 0.15mm² conductor, White component & Black Jacket
 VG95218T022D011 : 1 x 3.00mm² conductor, White component & Black Jacket

VG 95218 Part 23 Type C

VG 95218 T023 C – Multi Core Insulated Wire, Twisted Pair, Shielded & Jacketed Cable

- **Construction:** 2 x VG95218T020E single elements, twisted with overall shield and jacket
- **Conductor:** Stranded tin-coated copper
- **Insulation:** Halogen Free Polymer (Primary & Primary jacket)
- **Shield Material/Type:** Tin-coated copper / Optimized Woven Shield
- **Overall Jacket:** Zerohal jacketing material
- **Temperature Rating:** -40°C to +105°C
- **Voltage Rating:** 600V AC / 900V DC

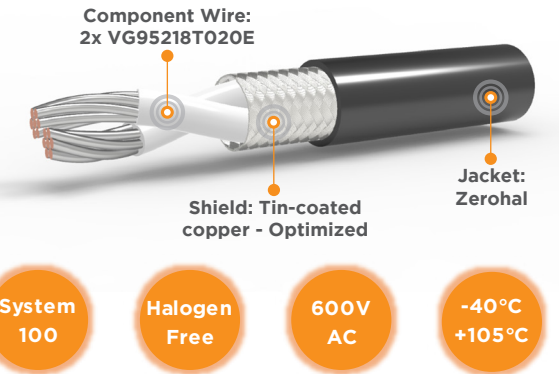

System 100 Halogen Free 600V AC -40°C +105°C

Applications

Raychem cable fully approved VG 95218 T023 Type C is a twisted pair, shielded and jacketed cable containing two VG95218T020E single wire elements. VG 95218 T020 Type E wire has a dual-wall insulated construction formulated using Halogen Free polymer blends. Developed to meet the VG specification whilst maintaining desirable features of small size, lightweight, excellent handling, flexibility and fluid resistance properties. The woven outer shield is optimized to achieve screening efficiency against sensitive lines or high EMI. The Zerohal outer jacket offers increased mechanical and environmental protection properties whilst meeting toxicity, smoke density, halogen free, corrosivity and flame retardant requirements of the VG specification.

Product Information Table

Part Description (Non-marked Components)	Part Description (Marked Components)	Nominal Conductor Cross Section (mm ²)	Wire Size Code (VG Dash No.)	Component Wire Description	Max. Resistance @ 20°C (Ohms/km)	Shield Size (mm)	FINISHED CABLE					
							Jacket Thickness (mm)		Diameter (mm)			Max. Weight (kg/km)
							Min.	Nom.	Min.	Nom.	Max.	
VG95218T023C034	VG95218T023C134	0.15	34	VG95218T020E129	135.00	0.10	0.15	0.28	2.92	3.06	3.22	15.90
VG95218T023C001	VG95218T023C101	0.25	01	VG95218T020E019	85.60	0.10	0.15	0.28	3.13	3.29	3.45	18.90
VG95218T023C002	VG95218T023C102	0.40	02	VG95218T020E029	51.50	0.13	0.15	0.28	3.60	3.78	3.98	26.50
VG95218T023C003	VG95218T023C103	0.50	03	VG95218T020E039	40.90	0.13	0.15	0.28	3.76	3.92	4.16	30.40
VG95218T023C004	VG95218T023C104	0.60	04	VG95218T020E049	31.70	0.13	0.15	0.28	3.95	4.16	4.37	33.30
VG95218T023C005	VG95218T023C105	0.75	05	VG95218T020E059	27.20	0.13	0.15	0.28	4.19	4.32	4.63	37.40
VG95218T023C006	VG95218T023C106	1.00	06	VG95218T020E069	20.40	0.13	0.15	0.28	4.38	4.61	4.84	42.30
VG95218T023C007	VG95218T023C107	1.20	07	VG95218T020E079	15.60	0.13	0.15	0.28	4.73	4.98	5.23	50.20
VG95218T023C008	n/a	1.50	08	VG95218T020E089	14.00	0.13	0.15	0.28	5.02	5.28	5.54	56.70
VG95218T023C009	n/a	2.00	09	VG95218T020E099	10.70	0.13	0.15	0.28	5.55	5.84	6.13	68.70
VG95218T023C010	n/a	2.50	10	VG95218T020E109	8.37	0.13	0.15	0.28	5.92	6.22	6.54	81.50
VG95218T023C011	n/a	3.00	11	VG95218T020E119	6.71	0.13	0.15	0.28	6.35	6.68	7.01	95.00

- NOTES:**
- VG descriptions in table are only available in white insulation & black jacket.
 - * Core number marking is available on sizes 0.15mm² to 1.20mm². Cores shall be marked "1" & "2" as per VG 95218-2 Clause 5.1.2.2.
 - * Components for the above cables shall be as listed under "Component Wire Description" column. e.g. Components for VG95218T023C034/134 shall be VG95218T020E129.
 - * Values are for guidance only, refer to drawings for maintained product information.

TABLE COLOR KEY:

- System 25
- System 100
- System 200

VG Part Description

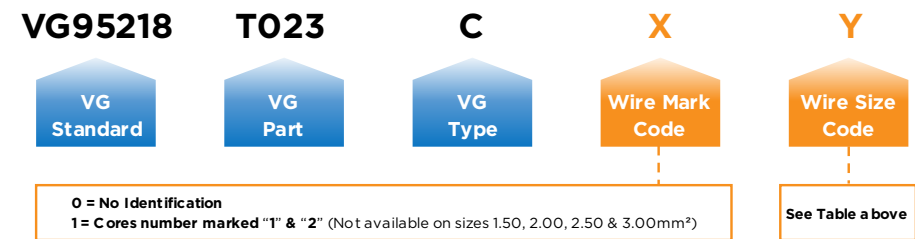

Examples:
 VG95218T023C034 : 2 x 0.15mm² conductors, White components & Black Jacket
 VG95218T023C134 : 2 x 0.15mm² conductors, White, number marked components & Black Jacket

VG 95218 Part 23 Type C

VG 95218 T023 C – Multi Core Insulated Wire, Twisted Triple, Shielded & Jacketed Cable

- **Construction:** 3 x VG95218T020E single elements, twisted with overall shield and jacket
- **Conductor:** Stranded tin-coated copper
- **Insulation:** Halogen Free Polymer (Primary & Primary jacket)
- **Shield Material/Type:** Tin-coated copper / Optimized Woven Shield
- **Overall Jacket:** Zerohal jacketing material
- **Temperature Rating:** -40°C to +105°C
- **Voltage Rating:** 600V AC / 900V DC

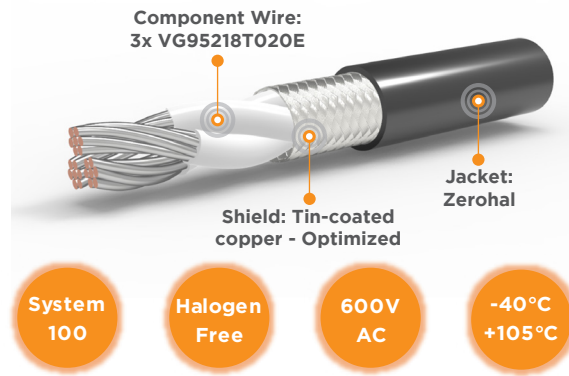

Applications

Raychem cable fully approved VG 95218 T023 Type C is a twisted triple, shielded and jacketed cable containing three VG95218T020E single wire elements. VG 95218 T020 Type E wire has a dual-wall insulated construction formulated using Halogen Free polymer blends. Developed to meet the VG specification whilst maintaining desirable features of small size, lightweight, excellent handling, flexibility and fluid resistance properties. The woven outer shield is optimized to achieve screening efficiency against sensitive lines or high EMI. The Zerohal outer jacket offers increased mechanical and environmental protection properties whilst meeting toxicity, smoke density, halogen free, corrosivity and flame retardant requirements of the VG specification.

Product Information Table

Part Description (Non-marked Components)	Part Description (Marked Components)	Nominal Conductor Cross Section (mm ²)	Wire Size Code (VG Dash No.)	Component Wire Description	Max. Resistance @ 20°C (Ohms/km)	Shield Size (mm)	FINISHED CABLE					Max. Weight (kg/km)
							Jacket Thickness (mm)		Diameter (mm)			
							Min.	Nom.	Min.	Nom.	Max.	
VG95218T023C035	VG95218T023C135	0.15	35	VG95218T020E129	135.00	0.10	0.15	0.28	3.07	3.22	3.39	20.10
VG95218T023C012	VG95218T023C112	0.25	12	VG95218T020E019	85.60	0.13	0.15	0.28	3.41	3.58	3.77	26.90
VG95218T023C013	VG95218T023C113	0.40	13	VG95218T020E029	51.50	0.13	0.15	0.28	3.80	4.00	4.20	34.10
VG95218T023C014	VG95218T023C114	0.50	14	VG95218T020E039	40.90	0.13	0.15	0.28	3.98	4.19	4.40	39.50
VG95218T023C015	VG95218T023C115	0.60	15	VG95218T020E049	31.70	0.13	0.15	0.28	4.18	4.40	4.62	43.60
VG95218T023C016	VG95218T023C116	0.75	16	VG95218T020E059	27.20	0.13	0.15	0.28	4.43	4.67	4.91	49.40
VG95218T023C017	VG95218T023C117	1.00	17	VG95218T020E069	20.40	0.13	0.15	0.28	4.65	4.89	5.13	56.20
VG95218T023C018	VG95218T023C118	1.20	18	VG95218T020E079	15.60	0.13	0.15	0.28	5.03	5.29	5.55	67.40
VG95218T023C019	n/a	1.50	19	VG95218T020E089	14.00	0.13	0.15	0.28	5.33	5.61	5.89	76.60
VG95218T023C020	n/a	2.00	20	VG95218T020E099	10.70	0.13	0.15	0.28	5.91	6.22	6.53	92.80
VG95218T023C021	n/a	2.50	21	VG95218T020E109	8.37	0.13	0.15	0.28	6.31	6.64	6.97	112.00
VG95218T023C022	n/a	3.00	22	VG95218T020E119	6.71	0.13	0.15	0.28	6.76	7.12	7.48	131.00

NOTES:

- VG descriptions in table are only available in white insulation & black jacket.
- Core number marking is available on sizes 0.15mm² to 1.20mm². Cores shall be marked "1", "2" & "3" as per VG 95218-2 Clause 5.1.2.2.
- Components for the above cables shall be as listed under "Component Wire Description" column. e.g. Components for VG95218T023C035/135 shall be VG95218T020E129.

TABLE COLOR KEY:

- System 25
- System 100
- System 200

VG Part Description

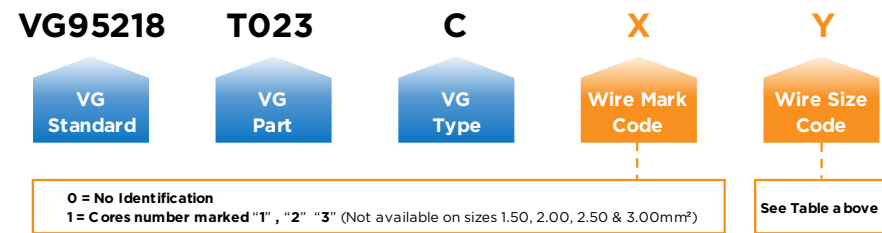

Examples:

VG95218T023C035 : 3 x 0.15mm² conductors, White components & Black Jacket
 VG95218T023C135 : 3 x 0.15mm² conductors, White, number marked components & Black Jacket

VG 95218 Part 23 Type C

VG 95218 T023 C – Multi Core Insulated Wire, Twisted Quad, Shielded & Jacketed Cable

- **Construction:** 4 x VG95218T020E single elements, twisted with overall shield and jacket
- **Conductor:** Stranded tin-coated copper
- **Insulation:** Halogen Free Polymer (Primary & Primary jacket)
- **Shield Material/Type:** Tin-coated copper / Optimized Woven Shield
- **Overall Jacket:** Zerohal jacketing material
- **Temperature Rating:** -40°C to +105°C
- **Voltage Rating:** 600V AC / 900V DC

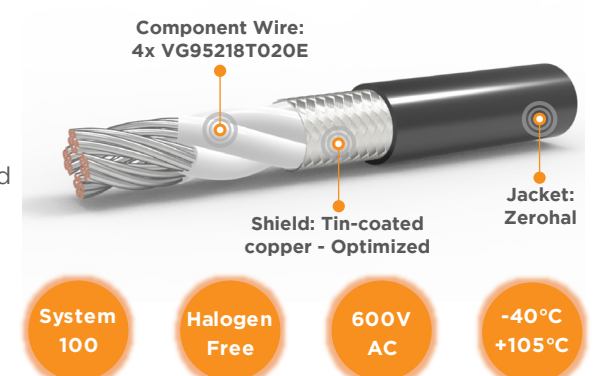

Applications

Raychem cable fully approved VG 95218 T023 Type C is a twisted quad, shielded and jacketed cable containing four VG95218T020E single wire elements. VG 95218 T020 Type E wire has a dual-wall insulated construction formulated using Halogen Free polymer blends. Developed to meet the VG specification whilst maintaining desirable features of small size, lightweight, excellent handling, flexibility and fluid resistance properties. The woven outer shield is optimized to achieve screening efficiency against sensitive lines or high EMI. The Zerohal outer jacket offers increased mechanical and environmental protection properties whilst meeting toxicity, smoke density, halogen free, corrosivity and flame retardant requirements of the VG specification.

Product Information Table

Part Description (Non-marked Components)	Part Description (Marked Components)	Nominal Conductor Cross Section (mm ²)	Wire Size Code (VG Dash No.)	Component Wire Description	Max. Resistance @ 20°C (Ohms/km)	Shield Size (mm)	FINISHED CABLE					Max. Weight (kg/km)
							Jacket Thickness (mm)		Diameter (mm)			
							Min.	Nom.	Min.	Nom.	Max.	
VG95218T023C036	VG95218T023C136	0.15	36	VG95218T020E129	135.00	0.13	0.15	0.28	3.43	3.60	3.79	27.00
VG95218T023C023	VG95218T023C123	0.25	23	VG95218T020E019	85.60	0.13	0.15	0.28	3.69	3.88	4.07	32.60
VG95218T023C024	VG95218T023C124	0.40	24	VG95218T020E029	51.50	0.13	0.15	0.28	4.13	4.33	4.55	41.70
VG95218T023C025	VG95218T023C125	0.50	25	VG95218T020E039	40.90	0.13	0.15	0.28	4.31	4.49	4.77	48.70
VG95218T023C026	VG95218T023C126	0.60	26	VG95218T020E049	31.70	0.13	0.15	0.28	4.54	4.78	5.02	54.00
VG95218T023C027	VG95218T023C127	0.75	27	VG95218T020E059	27.20	0.13	0.15	0.28	4.82	4.97	5.34	61.30
VG95218T023C028	VG95218T023C128	1.00	28	VG95218T020E069	20.40	0.13	0.15	0.28	5.05	5.32	5.59	70.30
VG95218T023C029	VG95218T023C129	1.20	29	VG95218T020E079	15.60	0.13	0.15	0.28	5.48	5.77	6.06	84.80
VG95218T023C030	n/a	1.50	30	VG95218T020E089	14.00	0.13	0.15	0.28	5.82	6.13	6.44	96.70
VG95218T023C031	n/a	2.00	31	VG95218T020E099	10.70	0.13	0.35	0.48	6.86	7.21	7.57	127.00
VG95218T023C032	n/a	2.50	32	VG95218T020E109	8.37	0.13	0.35	0.48	7.31	7.66	8.06	152.00
VG95218T023C033	n/a	3.00	33	VG95218T020E119	6.71	0.13	0.35	0.48	7.83	8.22	8.63	178.00

NOTES:

- VG descriptions in table are only available in white insulation & black jacket.
- Core number marking is available on sizes 0.15mm² to 1.20mm². Cores shall be marked "1", "2", "3" & "4" as per VG 95218-2 Clause 5.1.2.2.
- Components for the above cables shall be as listed under "Component Wire Description" column. e.g. Components for VG95218T023C036/136 shall be VG95218T020E129.

TABLE COLOR KEY:

- System 25
- System 100
- System 200

VG Part Description

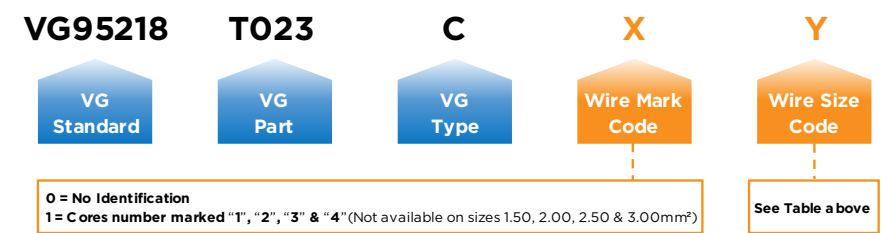

Examples:

VG95218T023C036 : 4 x 0.15mm² conductors, White components & Black Jacket
 VG95218T023C136 : 4 x 0.15mm² conductors, White, number marked components & Black Jacket

VG 95218 Part 23 Type C

VG 95218 T023 C – Multi Core Insulated Wire, Twisted Heptad, Shielded & Jacketed Cable

- **Construction:** 7 x VG95218T020E single elements, twisted with overall shield and jacket
- **Conductor:** Stranded tin-coated copper
- **Insulation:** Halogen Free Polymer (Primary & Primary jacket)
- **Shield Material/Type:** Tin-coated copper / Optimized Woven Shield
- **Overall Jacket:** Zerohal jacketing material
- **Temperature Rating:** -40°C to +105°C

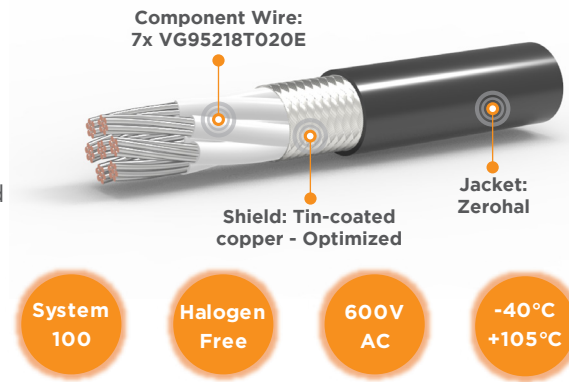

Applications

Raychem cable fully approved VG 95218 T023 Type C is a twisted heptad, shielded and jacketed cable containing seven VG95218T020E single wire elements. VG 95218 T020 Type E wire has a dual-wall insulated construction formulated using Halogen Free polymer blends. Developed to meet the VG specification whilst maintaining desirable features of small size, lightweight, excellent handling, flexibility and fluid resistance properties. The woven outer shield is optimized to achieve screening efficiency against sensitive lines or high EMI. The Zerohal outer jacket offers increased mechanical and environmental protection properties whilst meeting toxicity, smoke density, halogen free, corrosivity and flame retardant requirements of the VG specification.

Product Information Table

Part Description	Nominal Conductor Cross Section (mm ²)	Wire Size Code (VG Dash No.)	Component Wire Description	Max. Resistance @ 20°C (Ohms/km)	Shield Size (mm)	FINISHED CABLE					Max. Weight (kg/km)
						Jacket Thickness (mm)		Diameter (mm)			
						Min.	Nom.	Min.	Nom.	Max.	
VG95218T023C037	1.20	037	VG95218T020E079	15.80	0.13	0.20	0.60	7.26	7.55	7.93	150.00

- NOTES:**
- VG descriptions in table are only available in white insulation & black jacket.
 - Components for the above cables shall be as listed under "Component Wire Description" column. e.g. Components for VG95218T023C037 shall be VG95218T020E079.
 - Values are for guidance only, refer to drawings for maintained product information.

TABLE COLOR KEY:

System 25
System 100
System 200

VG Part Description

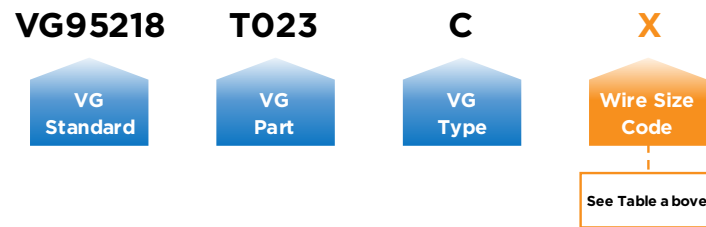

Examples:
 VG95218T023C037 : 7 x 1.20mm² conductor, White component & Black Jacket

VG 95218 Part 23 Type F

VG 95218 T023 F – Multi Core Insulated Wire, Twisted Pair, Shielded & Jacketed Cable

- **Construction:** 2 x VG95218T020A single elements, twisted with overall shield and jacket
- **Conductor:** Stranded tin-coated copper
- **Insulation:** Polyalkene (Primary), PVDF (Primary jacket)
- **Shield Material/Type:** Tin-coated copper / Optimized Woven Shield
- **Overall Jacket:** PVDF
- **Temperature Rating:** -40°C to +150°C
- **Voltage Rating:** 600V AC / 900V DC

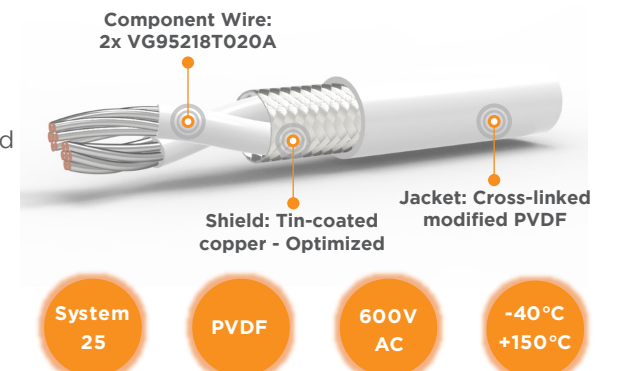

Applications

Raychem cable fully approved VG 95218 T023 Type F is a twisted pair, shielded and jacketed cable containing two VG95218T020A single wire elements. VG 95218 T020 Type A wire has a dual-wall construction which combines the outstanding physical and electrical characteristics of radiation crosslinked Polyalkene, with the excellent mechanical and chemical properties of radiation cross-linked polyvinylidene fluoride (PVDF). The woven outer shield is optimized to achieve screening efficiency against sensitive lines or high EMI. The PVDF outer jacket offers increased mechanical and environmental protection properties.

Product Information Table

Part Description	Nominal Conductor Cross Section (mm ²)	Wire Size Code (VG Dash No.)	Component Wire Description	Max. Resistance @ 20°C (Ohms/km)	Shield Size (mm)	FINISHED CABLE						Max. Weight (kg/km)	MTV Part Number 6145-005-
						Jacket Thickness (mm)		Diameter (mm)					
						Min.	Nom.	Lower Spec Limit	Target	Upper Spec Limit			
VG95218T023F010	0.25	010	VG95218T020A016	87.70	0.13	0.15	0.20	2.87	3.00	3.12	16.90	F010	
VG95218T023F001	0.40	001	VG95218T020A001	54.20	0.13	0.15	0.20	3.25	3.35	3.48	21.60	F001	
VG95218T023F002	0.60	002	VG95218T020A003	34.20	0.13	0.15	0.20	3.66	3.75	3.89	28.00	F002	
VG95218T023F011	1.00	011	VG95218T020A005	21.40	0.13	0.18	0.23	4.17	4.37	4.42	38.30	F011	
VG95218T023F013	1.20	013	VG95218T020A006	16.70	0.13	0.18	0.23	4.52	4.72	4.78	45.00	F013	
VG95218T023F003	2.50	003	VG95218T020A008	8.37	0.13	0.20	0.25	6.00	6.14	6.45	78.60	F003	
VG95218T023F018	3.00	018	VG95218T020A017	6.96	0.13	0.20	0.25	6.52	6.68	6.84	91.50	N/A	

- NOTES:**
- VG descriptions in table are only available in white color (Insulation & Jacket).
 - Component for the above cables shall be as listed under "Component Wire Description" column. e.g. Component for VG95218T023F010 shall be VG95218T020A016.
 - Values are for guidance only, refer to drawings for maintained product information.

TABLE COLOR KEY:

System 25
System 100
System 200

VG Part Description

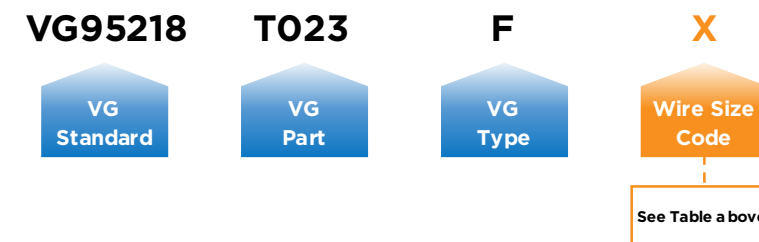

Examples:
 VG95218T023F010 : 2 x 0.25mm² conductor, White component & White Jacket
 VG95218T023F018 : 2 x 3.00mm² conductor, White component & White Jacket

VG 95218 Part 23 Type F



VG 95218 T023 F – Multi Core Insulated Wire, Twisted Triple, Shielded & Jacketed Cable

- **Construction:** 3 x VG95218T020A single elements, twisted with overall shield and jacket
- **Conductor:** Stranded tin-coated copper
- **Insulation:** Polyalkene (Primary), PVDF (Primary jacket)
- **Shield Material/Type:** Tin-coated copper / Optimized Woven Shield
- **Overall Jacket:** PVDF
- **Temperature Rating:** -40°C to +150°C

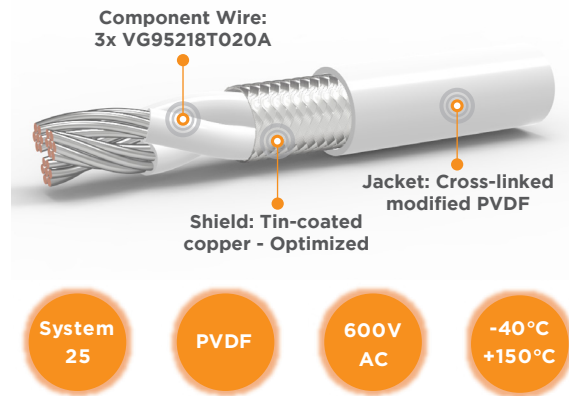

Applications

Raychem cable fully approved VG 95218 T023 Type F is a twisted triple, shielded and jacketed cable containing three VG95218T020A single wire elements. VG 95218 T020 Type A wire has a dual-wall construction which combines the outstanding physical and electrical characteristics of radiation crosslinked Polyalkene, with the excellent mechanical and chemical properties of radiation cross-linked polyvinylidene fluoride (PVDF). The woven outer shield is optimized to achieve screening efficiency against sensitive lines or high EMI. The PVDF outer jacket offers increased mechanical and environmental protection properties.

Product Information Table

Part Description	Nominal Conductor Cross Section (mm ²)	Wire Size Code (VG Dash No.)	Component Wire Description	Max. Resistance @ 20°C (Ohms/km)	Shield Size (mm)	FINISHED CABLE						Max. Weight (kg/km)	MTV Part Number 6145-005-
						Jacket Thickness (mm)		Diameter (mm)					
						Min.	Nom.	Lower Spec Limit	Target	Upper Spec Limit			
VG95218T023F006	0.25	006	VG95218T020A016	87.70	0.13	0.15	0.20	3.02	3.15	3.28	21.40	F006	
VG95218T023F004	0.40	004	VG95218T020A001	54.20	0.13	0.15	0.20	3.43	3.54	3.68	28.00	F004	
VG95218T023F005	0.60	005	VG95218T020A003	34.20	0.13	0.15	0.20	3.86	3.98	4.14	37.20	F005	
VG95218T023F014	1.00	014	VG95218T020A005	21.40	0.13	0.18	0.23	4.42	4.63	4.67	51.30	F014	
VG95218T023F015	1.20	015	VG95218T020A006	16.70	0.13	0.18	0.23	4.80	5.02	5.08	61.10	F015	

- NOTES:**
- VG descriptions in table are only available in white color (Insulation & Jacket).
 - Component for the above cables shall be as listed under "Component Wire Description" column. e.g. Component for VG95218T023F006 shall be VG95218T020A016.
 - Values are for guidance only, refer to drawings for maintained product information.

TABLE COLOR KEY:

System 25
System 100
System 200

VG Part Description

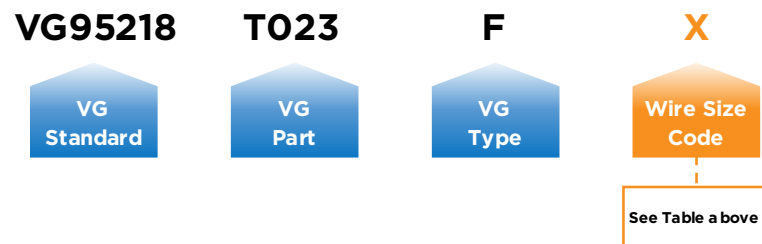

Examples:

- VG95218T023F006 : 3 x 0.25mm² conductor, White component & White Jacket
- VG95218T023F015 : 3 x 1.20mm² conductor, White component & White Jacket

VG 95218 Part 23 Type F



VG 95218 T023 F – Multi Core Insulated Wire, Twisted Quad, Shielded & Jacketed Cable

- **Construction:** 4 x VG95218T020A single elements, twisted with overall shield and jacket
- **Conductor:** Stranded tin-coated copper
- **Insulation:** Polyalkene (Primary), PVDF (Primary jacket)
- **Shield Material/Type:** Tin-coated copper / Optimized Woven Shield
- **Overall Jacket:** PVDF
- **Temperature Rating:** -40°C to +150°C
- **Voltage Rating:** 600V AC / 900V DC

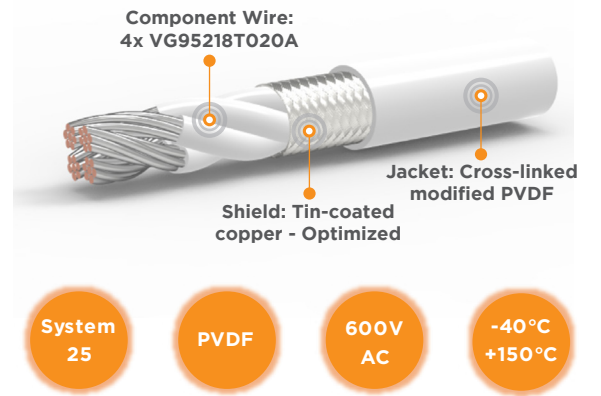

Applications

Raychem cable fully approved VG 95218 T023 Type F is a twisted quad shielded and jacketed cable containing four VG95218T020A single wire elements. VG 95218 T020 Type A wire has a dual-wall construction which combines the outstanding physical and electrical characteristics of radiation crosslinked Polyalkene, with the excellent mechanical and chemical properties of radiation cross-linked polyvinylidene fluoride (PVDF). The woven outer shield is optimized to achieve screening efficiency against sensitive lines or high EMI. The PVDF outer jacket offers increased mechanical and environmental protection properties.

Product Information Table

Part Description	Nominal Conductor Cross Section (mm ²)	Wire Size Code (VG Dash No.)	Component Wire Description	Max. Resistance @ 20°C (Ohms/km)	Shield Size (mm)	FINISHED CABLE						Max. Weight (kg/km)	MTV Part Number 6145-005-
						Jacket Thickness (mm)		Diameter (mm)					
						Min.	Nom.	Lower Spec Limit	Target	Upper Spec Limit			
VG95218T023F009	0.25	009	VG95218T020A016	87.70	0.13	0.15	0.20	3.30	3.41	3.58	26.60	F009	
VG95218T023F007	0.40	007	VG95218T020A001	54.20	0.13	0.15	0.20	3.75	3.84	4.03	35.20	F007	
VG95218T023F008	0.60	008	VG95218T020A003	34.20	0.13	0.18	0.23	4.27	4.38	4.60	47.40	F008	
VG95218T023F012	1.00	012	VG95218T020A005	21.40	0.13	0.18	0.23	4.83	5.05	5.26	64.70	F012	
VG95218T023F016	1.20	016	VG95218T020A006	16.70	0.13	0.18	0.23	5.26	5.48	5.77	77.70	F016	

- NOTES:**
- VG descriptions in table are only available in white color (Insulation & Jacket).
 - Component for the above cables shall be as listed under "Component Wire Description" column. e.g. Component for VG95218T023F009 shall be VG95218T020A016.
 - Values are for guidance only, refer to drawings for maintained product information.

TABLE COLOR KEY:

System 25
System 100
System 200

VG Part Description

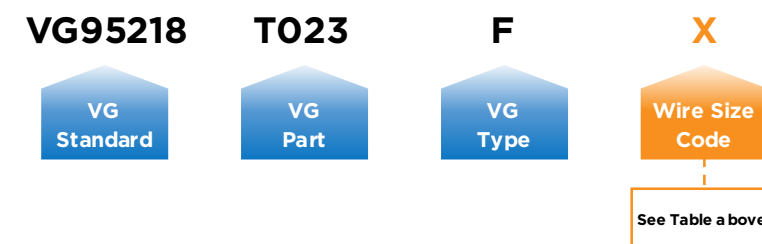

Examples:

- VG95218T023F009 : 4 x 0.25mm² conductor, White component & White Jacket
- VG95218T023F016 : 4 x 1.20mm² conductor, White component & White Jacket

VG 95218 Part 23 Type F



VG 95218 T023 F - Multi Core Insulated Wire, Twisted Pentad, Shielded & Jacketed Cable

- **Construction:** 5 x VG95218T020A single elements, twisted with overall shield and jacket
- **Conductor:** Stranded tin-coated copper
- **Insulation:** Polyalkene (Primary), PVDF (Primary jacket)
- **Shield Material/Type:** Tin-coated copper / Optimized Woven Shield
- **Overall Jacket:** PVDF
- **Temperature Rating:** -40°C to +150°C
- **Voltage Rating:** 600V AC / 900V DC

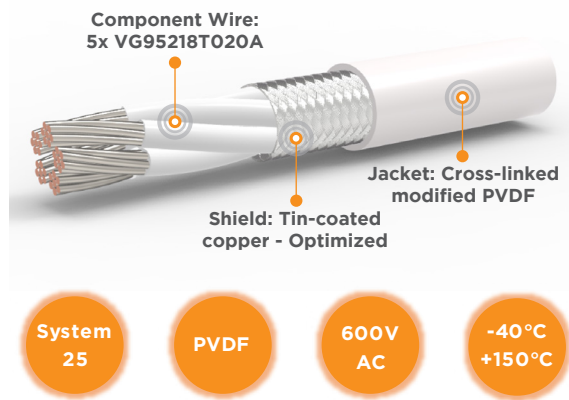

System 25 PVDF 600V AC -40°C +150°C

Applications

Raychem cable fully approved VG 95218 T023 Type F is a twisted pentad shielded and jacketed cable containing five VG95218T020A single wire elements. VG 95218 T020 Type A wire has a dual-wall construction which combines the outstanding physical and electrical characteristics of radiation crosslinked Polyalkene, with the excellent mechanical and chemical properties of radiation cross-linked polyvinylidene fluoride (PVDF). The woven outer shield is optimized to achieve screening efficiency against sensitive lines or high EMI. The PVDF outer jacket offers increased mechanical and environmental protection properties.

Product Information Table

Part Description	Nominal Conductor Cross Section (mm ²)	Wire Size Code (VG Dash No.)	Component Wire Description	Max. Resistance @ 20°C (Ohms/km)	Shield Size (mm)	FINISHED CABLE						
						Jacket Thickness (mm)		Diameter (mm)			Max. Weight (kg/km)	MTV Part Number 6145-005-
						Min.	Nom.	Lower Spec Limit	Target	Upper Spec Limit		
VG95218T023F020	1.20	020	VG95218T020A006	16.70	0.13	0.18	0.23	5.86	6.02	6.30	100.00	F006

- NOTES:**
- VG descriptions in table are only available in white color (Insulation & Jacket).
 - Component for the above cables shall be as listed under "Component Wire Description" column. e.g. Component for VG95218T023F020 shall be VG95218T020A006.
 - Values are for guidance only, refer to drawings for maintained product information.

TABLE COLOR KEY:

- System 25
- System 100
- System 200

VG Part Description

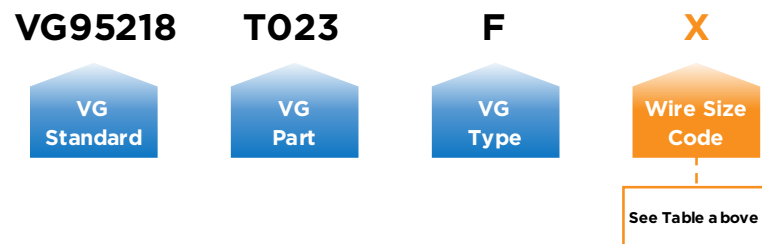

Example:
VG95218T023F020 : 5 x 1.20mm² conductor, White component & White Jacket

VG 95218 Part 23 Type F



VG 95218 T023 F - Multi Core Insulated Wire, Twisted Hexad, Shielded & Jacketed Cable

- **Construction:** 6 x VG95218T020A single elements, twisted with overall shield and jacket
- **Conductor:** Stranded tin-coated copper
- **Insulation:** Polyalkene (Primary), PVDF (Primary jacket)
- **Shield Material/Type:** Tin-coated copper / Optimized Woven Shield
- **Overall Jacket:** PVDF
- **Temperature Rating:** -40°C to +150°C
- **Voltage Rating:** 600V AC / 900V DC

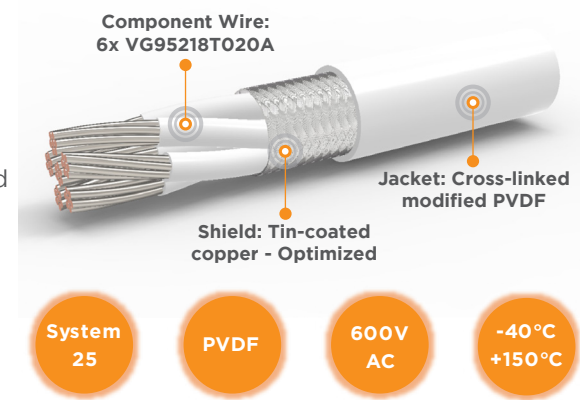

System 25 PVDF 600V AC -40°C +150°C

Applications

Raychem cable fully approved VG 95218 T023 Type F is a twisted hexad shielded and jacketed cable containing six VG95218T020A single wire elements. VG 95218 T020 Type A wire has a dual-wall construction which combines the outstanding physical and electrical characteristics of radiation crosslinked Polyalkene, with the excellent mechanical and chemical properties of radiation cross-linked polyvinylidene fluoride (PVDF). The woven outer shield is optimized to achieve screening efficiency against sensitive lines or high EMI. The PVDF outer jacket offers increased mechanical and environmental protection properties.

Product Information Table

Part Description	Nominal Conductor Cross Section (mm ²)	Wire Size Code (VG Dash No.)	Component Wire Description	Max. Resistance @ 20°C (Ohms/km)	Shield Size (mm)	FINISHED CABLE						
						Jacket Thickness (mm)		Diameter (mm)			Max. Weight (kg/km)	MTV Part Number 6145-005-
						Min.	Nom.	Lower Spec Limit	Target	Upper Spec Limit		
VG95218T023F021	1.20	020	VG95218T020A006	16.70	0.13	0.20	0.25	6.45	6.61	6.90	128.00	F009

- NOTES:**
- VVG descriptions in table are only available in white color (Insulation & Jacket).
 - Component for the above cables shall be as listed under "Component Wire Description" column. e.g. Component for VG95218T023F021 shall be VG95218T020A006.
 - Values are for guidance only, refer to drawings for maintained product information.

TABLE COLOR KEY:

- System 25
- System 100
- System 200

VG Part Description

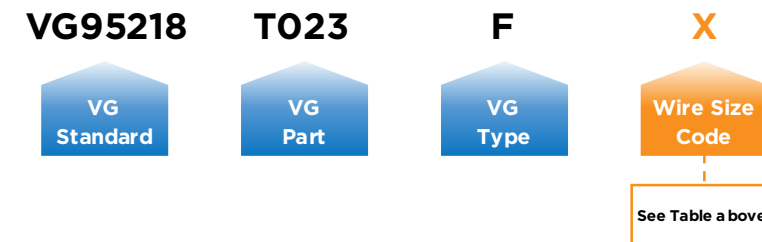

Example:
VG95218T023F021 : 6 x 1.20mm² conductor, White component & White Jacket

VG 95218 Part 24 Type K



VG 95218 T024 K – Single Core Insulated Wire

- **Construction:** Dual wall construction
- **Conductor:** Stranded tin-coated copper
mm² = IEC 228 Class 6
AWG = Flexible, rope stranded
- **Insulation:** Fire Retardant Flexible Polyolefin (Primary - Thermorad) & Fuel & Diesel Resistant Elastomer (Primary Jacket - FDR25)
- **Temperature Rating:** -40°C to +150°C
- **Voltage Rating:** 600V AC / 900V DC

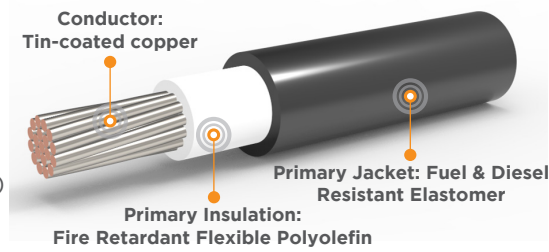

Applications

Raychem wire fully approved VG 95218 T024 Type K has a dual-wall construction. Consisting of TE's Thermorad Primary insulation and FDR25 jacket, developed for harsh environments. Both materials are highly flame retardant and provides excellent mechanical properties. Offering low temperature flexibility and resistance to a wide range of aggressive chemicals/fluids.

Product Information Table

Part Description	Wire Size & Insulation Color Code (VG Dash No.)			Cable Size (mm ²)/AWG		CONDUCTOR				INSULATION			FINISHED WIRE						
	White	Black	Blue	mm ²	AWG	No. of Strands	Max Strand Diameter (mm)	Diameter (mm)		Max. Resistance @ 20°C (Ohms/km)	Min. Wall (mm)	Diameter (mm)			Max. Weight (kg/km)				
								Min.	Max.			Lower Spec	Target	Upper Spec					
VG95218T024K*	010	040	070	1.5	-	85	0.16	1.40	1.70	13.7	0.55	2.80	3.00	3.20	0.35	3.80	4.00	4.20	30
VG95218T024K*	011	041	071	2.5	-	7x20	0.16	2.20	2.60	8.21	0.57	3.70	3.90	4.10	0.37	4.70	5.00	5.30	47
VG95218T024K*	001	031	061	4.0	-	7x33	0.16	2.60	3.00	5.09	0.62	4.25	4.50	4.75	0.37	5.30	5.60	5.90	69
VG95218T024K*	002	032	062	6.0	-	7x27	0.21	3.30	3.80	3.39	0.62	4.95	5.20	5.45	0.37	6.00	6.30	6.60	94
VG95218T024K*	012	042	072	-	8	19x35	0.13	3.90	4.40	2.30	0.54	5.35	5.65	5.95	0.43	6.60	6.90	7.20	120
VG95218T024K*	003	033	063	10	-	19x17	0.21	4.30	4.80	1.95	0.63	5.90	6.20	6.50	0.45	7.10	7.50	7.90	147
VG95218T024K*	004	034	064	16	-	19x27	0.21	5.20	5.80	1.24	0.75	7.10	7.40	7.70	0.53	8.40	8.80	9.20	220
VG95218T024K*	005	035	065	25	-	37x21	0.21	6.90	7.70	0.795	0.80	9.00	9.30	9.60	0.53	10.20	10.70	11.20	323
VG95218T024K*	006	036	066	35	-	37x30	0.21	8.10	9.00	0.565	0.82	10.30	10.60	10.90	0.54	11.50	12.10	12.70	444
VG95218T024K*	007	037	067	50	-	37x19	0.31	9.60	10.70	0.393	0.93	12.10	12.45	12.80	0.54	13.30	14.00	14.70	619
VG95218T024K*	008	038	068	70	-	37x27	0.31	11.40	12.60	0.277	1.03	14.20	14.55	14.90	0.62	15.40	16.20	17.00	861
VG95218T024K*	009	039	069	95	-	37x36	0.31	13.30	14.80	0.210	1.23	16.60	17.00	17.40	0.71	17.90	18.80	19.70	1148

NOTES:

- * VG Part Description to be completed using Wire Size & Insulation Color code to determine size of conductor and color of insulation.
- VG descriptions in table are only available with black jacket.
- Insulation marking - The mark shall be: **Raychem - VG95218T024K### - K1010** where: "###" = Wire Size & Insulation Color Code
e.g: Size 2.5mm² with blue insulation and black jacket shall be marked: **Raychem - VG95218T024K071 - K1010**
- Values are for guidance only, refer to drawings for maintained product information.

TABLE COLOR KEY:



VG Part Description

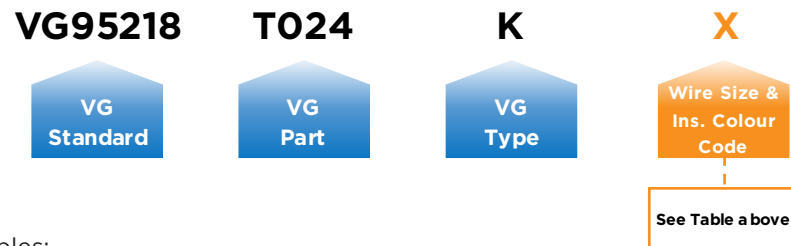

Examples:

- VG95218T024K010 : 1.5mm² conductor, White insulation & Black jacket,
- VG95218T024K069 : 95mm² conductor, Blue insulation & Black jacket

VG 95218 Part 25 Type G



VG 95218 T025 G – Single Core Insulated Wire

- **Construction:** Single wall construction
- **Conductor:** Stranded Bare copper, Flexible, rope stranded
- **Insulation:** Fuel & Diesel Resistant Elastomer - FDR25
- **Temperature Rating:** -40°C to +150°C
- **Voltage Rating:** 600V AC / 900V DC

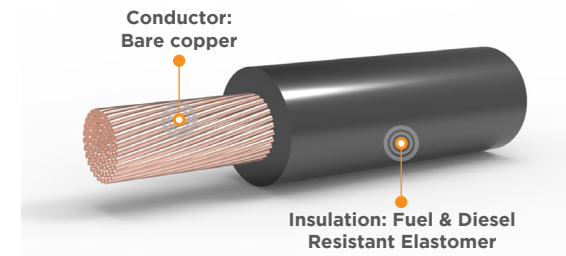

Applications

Raychem wire fully approved VG 95218 T025 Type G has a single-wall construction. A flexible power wire which is highly flame retardant and provides good mechanical properties Offering an extensive temperature range, low temperature flexibility and resistance to a wide range of aggressive chemicals/fluids such as hot diesel fuels and hydraulic fluids.

Product Information Table

Part Description	Cable Size (mm ²)	Wire Size Code (VG Dash No.)	CONDUCTOR					FINISHED WIRE					
			Number of Strands	Max. Strand Diameter (mm)	Diameter (mm)		Max. Resistance @ 20°C (Ohms/km)	Min. Wall (mm)	Diameter (mm)			Max. Weight (kg/km)	MTV Part Number 6145-005-
				Min.	Max.			Lower Spec Limit	Target	Upper Spec Limit			
VG95218T025G007	10	007	7x7x26	0.10	4.00	5.00	1.90	0.92	6.60	6.90	7.20	135	G007
VG95218T025G008	16	008	7x7x42	0.10	5.50	6.50	1.20	0.92	8.00	8.40	8.80	209	G008
VG95218T025G001	25	001	7x7x67	0.10	7.00	8.00	0.745	1.13	10.00	10.40	10.80	328	G001
VG95218T025G006	35	006	7x7x93	0.10	8.50	9.50	0.535	1.86	13.10	13.60	14.10	499	G006
VG95218T025G002	50	002	7x7x3x44	0.10	10.50	11.50	0.375	1.98	15.40	15.90	16.40	694	G002
VG95218T025G009	70	009	7x7x3x62	0.10	12.50	13.50	0.275	2.15	17.70	18.30	18.90	955	G009
VG95218T025G003	95	003	7x7x3x85	0.10	15.50	16.50	0.205	2.32	21.10	21.70	22.30	1343	G003
VG95218T025G010	120	010	7x7x4x80	0.10	17.00	19.00	0.16	2.49	23.10	24.10	25.10	1772	N/A
VG95218T025G004	150	004	7x7x7x57	0.10	19.50	21.50	0.128	2.36	25.30	26.30	27.30	1966	G004
VG95218T025G005	240	005	7x7x7x94	0.10	25.50	27.50	0.079	2.07	30.60	31.60	32.60	3085	G005

NOTES:

- VG Part Description to be completed using Wire Size code to determine size of conductor.
- VG descriptions in table are only available with black insulation.
- Insulation marking - The mark shall be: **Raychem - VG95218T025G### - K1010** where: "###" = Wire Size Code
- Values are for guidance only, refer to drawings for maintained product information.

TABLE COLOR KEY:



VG Part Description

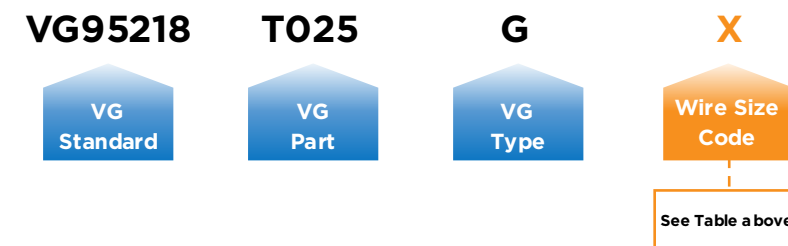

Examples:

- VG95218T025G007 : 10mm² conductor, Black insulation,
- VG95218T020G005 : 240mm² conductor, Black insulation

VG 95218 Part 27 Type A



VG 95218 T027 A – Multi Core, Primary Wires, Jacketed Cable

- **Construction:** Multiple VG95218T020E elements, with overall wrap and jacket
- **Conductor:** Stranded tin-coated copper - 1.00mm², 1.50mm², 2.50mm²
- **Insulation:** Halogen Free Polymer (Primary & Primary jacket)
- **Wrap:** Polyester (Overall)
- **Overall Jacket:** Zerohal jacketing material
- **Temperature Rating:** -40°C to +105°C
- **Voltage Rating:** 600V AC / 900V DC

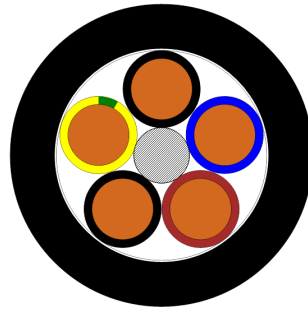

Illustrative Image - VG95218T027A013 example



Product Information Table

Part Description	No. of wires	No. of Wires x Cross Sectional Area (mm ²)	VG Dash No.	Component	Minimum Wall Thickness (mm)	FINISHED CABLE			
						Cable Diameter (mm)		Max. Weight (kg/km)	Max Resistance @ 20°C (Ohms/km)
						Min.	Max.		
VG95218T027A007	3	3G x 1.00	007	VG95218T020E061	0.75	61	20.60	493	57
				VG95218T020E066					
				VG95218T020E06G					
VG95218T027A004	19	19 x 1.00	004	VG95218T020E069	1.30	306	21.40	699	57
VG95218T027A006	61	61 x 1.00	006	VG95218T020E069	1.39	851	21.40		
VG95218T027A001	3	3 x 1.50	001	VG95218T020E089	0.75	84	14.00		
VG95218T027A008	3	3G x 1.50	008	VG95218T020E081	0.83	85	14.00	582	150
				VG95218T020E086					
				VG95218T020E08G					
VG95218T027A011	5	5 x 1.50	011	VG95218T020E089	0.92	134	14.00		
VG95218T027A013	5	5G x 1.50	013	VG95218T020E08G	0.92	134	14.00		
				VG95218T020E086					
				VG95218T020E080					
				VG95218T020E081					
				VG95218T020E088					
VG95218T027A002	7	7 x 1.50	002	VG95218T020E089	0.79	159	14.00		
VG95218T027A003	10	10 x 1.50	003	VG95218T020E089	0.84	224	14.60		
VG95218T027A012	12	12 x 1.50	012	VG95218T020E089	1.01	280	14.60		
VG95218T027A005	37	37 x 1.50	005	VG95218T020E089	1.30	764	14.60		
VG95218T027A014	5	5G x 2.50	014	VG95218T020E10G	0.92	194	8.50		
				VG95218T020E106					
				VG95218T020E101					
				VG95218T020E100					
				VG95218T020E108					

NOTES:

- VG descriptions in table are only available with a Black jacket.
- Component/s for the above cables shall be as listed under "Component" column. e.g. Components for VG95218T027A001 shall be VG95218T020E089.
- Fillers are used as required.
- Values are for guidance only, refer to drawings for maintained product information.

TABLE COLOR KEY:

	System 25
	System 100
	System 200

VG 95218 Part 27 Type A



VG 95218 T027 A – Multi Core, Primary Wires, Jacketed Cable

Component Identification

VG Dash No.- 001, 002, 003, 004, 005, 006, 011 & 012:

- White, Numbered

VG Dash No.- 007 & 008:

- Brown, Blue & Yellow/Green

VG Dash No.- 013 & 014:

- Black, Brown, Blue, Grey & Yellow/Green

Cable Jacket Identification

- The mark shall be: **Raychem - VG 95218 T027 A### - K1010 - VDE Reg.Nr. 7094**

where: "###" = VG Dash No.

e.g: VG95218T027A009 shall be marked: **Raychem - VG95218T027A009 - K1010 - VDE Reg.Nr. 7094**

- Color of mark shall be white.

VG Part Description

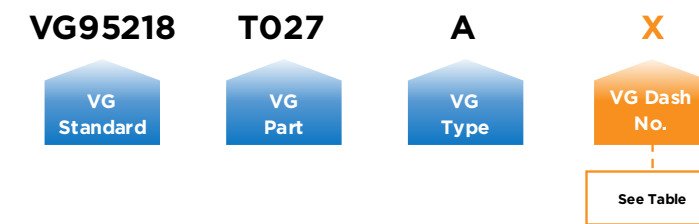

Examples:

- VG95218T027A006 : 61 x 1.00mm² conductors, White + Numbered components & Overall Black Jacket
- VG95218T027A014 : 5 x 2.50mm² conductors, Black, Brown, Blue, Grey, Yellow/Green components & Overall Black Jacket

VG 95218 Part 27 Type B



VG 95218 T027 B - Multi Core, Various components, Jacketed Cable

- **Construction:** Multiple VG95218T020A (Primary), VG95218T021E (Triples), VG95218T022C (Screened, Jacketed Primary) elements, with overall wrap and jacket
- **Conductor:** Stranded tin-coated copper - 0.25mm², 0.40mm², 0.60mm², 1.20mm²
- **Insulation:** Polyalkene (Primary), PVDF (Primary jacket)
- **Individual Shield Material/Type:** Tin-coated copper / Optimized Woven
- **Individual Jacket:** PVDF
- **Wrap:** Polyester (Overall, B022 & B025 Only)
- **Overall Jacket:** Fuel & Diesel Resistant Elastomer - FDR25
- **Temperature Rating:** -40°C to +150°C
- **Voltage Rating:** 600V AC / 900V DC

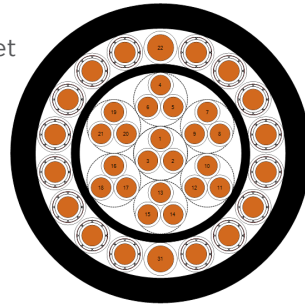

Illustrative Image - VG95218T027B010 example



Product Information Table

Part Description	No. of wires	No. of Wires x Cross Sectional Area (mm ²)	VG Dash No.	Component	Minimum Wall Thickness (mm)	FINISHED CABLE			Nato Stock Number 6145-12-	
						Cable Diameter (mm)		Max. Weight (kg/km)		Max Resistance @ 20°C (Ohms/km)
						Min.	Max.			
VG95218T027B007	12	4 x 0.40	007	VG95218T022C001	1.01	9.5	10.5	182	56.80	198-7079
		4 x 0.60		VG95218T020A003					34.20	
		4 x 1.20		VG95218T020A006					17.50	
VG95218T027B009	25	13 x 0.40	009	VG95218T022C001	1.09	12.6	14.0	310	56.80	198-7080
		3 x 3 x 0.60		VG95218T021E005					34.90	
		3 x 0.60		VG95218T020A003					34.20	
VG95218T027B010	39	16 x 0.40	010	VG95218T022C001	1.09	16.0	17.6	484	56.80	198-7081
		7 x 3 x 0.60		VG95218T021E005					34.20	
		2 x 1.20		VG95218T020A006					17.50	
VG95218T027B022	3	1 x 0.60	022	VG95218T020A003	0.62	6.0	6.6	65	34.20	321-2249
		2 x 0.60		VG95218T022C003					34.20	
VG95218T027B025	8	6 x 0.25	025	VG95218T020A016	0.75	6.4	7.0	67	87.70	331-8323
		2 x 0.25		VG95218T022C016					87.70	

NOTES:

- VG descriptions in table are only available with a Black jacket.
- Component/s for the above cables shall be as listed under "Component" column. e.g. Components for VG95218T027B025 shall be VG95218T020A016 & VG95218T022C016
- Fillers are used as required.

TABLE COLOR KEY:

- System 25
- System 100
- System 200

VG 95218 Part 27 Type B



VG 95218 T027 B - Multi Core, Various components, Jacketed Cable

Component Identification

VG Dash No.- 007, 022 & 025:

- Primaries - White Insulation - Numbered
- Screened Jacketed Primaries - White Insulation, White Jacket - Jacket numbered

VG Dash No.- 009:

- Primaries - White Insulation - Numbered
- Screened Jacketed Primaries - White Insulation, White Jacket - Jacket numbered
- Triples - White Insulation - Numbered

VG Dash No.- 010:

- Primaries - White Insulation - Numbered
- Screened Jacketed Primaries - White Insulation, White Jacket - Jacket numbered
- Central 7 Triples, Jacketed: Triples - White Insulation - Numbered, Black overall Jacket

Cable Jacket Identification

- The mark shall be: **Raychem - VG 95218 T027 B### - K1010 - VDE Reg.Nr. 9424** where: "###" = VG Dash No. e.g: VG95218T027B007 shall be marked: **Raychem - VG95218T027B007 - K1010 - VDE Reg.Nr. 9424**
- Color of mark shall be white.

VG Part Description

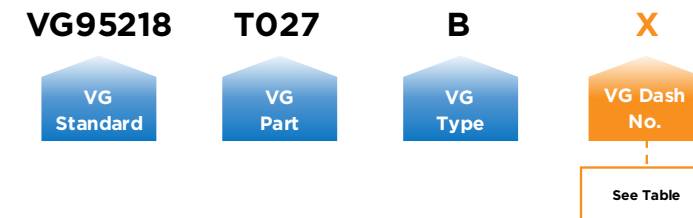

Examples:

VG95218T027B007 : 4 x 0.40mm², 4 x 0.60 & 4 x 1.20 conductors, Primaries: White + Numbered, Screened Jacketed Primaries: White component, White jacket - numbered components & Overall Black Jacket

VG 95218 Part 28 Type A



VG 95218 T028 A – Multi Core, Primary Wires, Double Overall Shielded & Jacketed Cable

- **Construction:** VG95218T020A or M81044 single elements, with overall wrap, double overall shield and jacket
- **Conductor:** Stranded tin-coated copper - 1.20mm², 1.50mm², 2.00mm²
- **Insulation:** Polyalkene (Primary), PVDF (Primary jacket)
- **Wrap:** Polyester (Overall)
- **Shield Material/Type:** Tin-coated copper / Optimized Woven Shield (A001/A004: Double shield) (A011: Double shield isolated with double wrap)
- **Overall Jacket:** Fuel & Diesel Resistant Elastomer - FDR25
- **Temperature Rating:** -40°C to +150°C

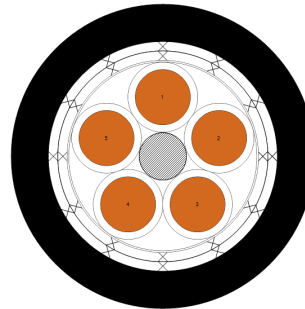

Illustrative Image - VG95218T028A004 example



Product Information Table

Part Description	No. of wires	No. of Wires x Cross Sectional Area (mm ²)	VG Dash No.	Component	Screen 1 - Strand Size		Screen 2 - Strand Size		Minimum Wall Thickness (mm)	Cable Diameter (mm)		Max. Weight (kg/km)	Max Resistance @ 20°C (Ohms/km)	Max. Transfer Impedance @ 30MHz (mOhms/m)	Nato Stock Number 6145-12-
					AWG	Nom. (mm)	AWG	Nom. (mm)		Min.	Max.				
					FINISHED CABLE										
VG95218T028A001	2	2 x 1.20	001	VG95218T020A006	36	0.127	36	0.127	0.84	6.7	7.5	100	16.70	10	325-0724
VG95218T028A004	5	5 x 1.50	004	VG95218T020A007	36	0.127	36	0.127	0.92	8.6	9.6	186	13.80	10	326-7800
VG95218T028A011	7	7 x 1 x 2.00	011	2 M81044/12-14-6	34	0.160	34	0.160	1.13	11.0	12.0	307	10.20	10	---
				1 M81044/12-14-4											
				4 M81044/12-14-8											

- NOTES:**
- VG descriptions in table are only available with a Black jacket.
 - Component/s for the above cables shall be as listed under "Component" column. e.g. Components for VG95218T028A001 shall be VG95218T020A006.
 - Fillers are used as required.
 - Values are for guidance only, refer to drawings for maintained product information.

TABLE COLOR KEY:

System 25
System 100
System 200

Component Identification

VG Dash No.- 001, 004:

- White, Numbered

VG Dash No.- 011:

- 1 x Yellow, 2 x Blue, 4 x Grey

Cable Jacket Identification

- The mark shall be: **Raychem - VG 95218 T028 A### - K1010 - VDE Reg.Nr. 9425** where: "###" = VG Dash No. e.g: VG95218T028A001 shall be marked: **Raychem - VG95218T028A001 - K1010 - VDE Reg.Nr. 9425**
- Color of mark shall be white.

VG Part Description

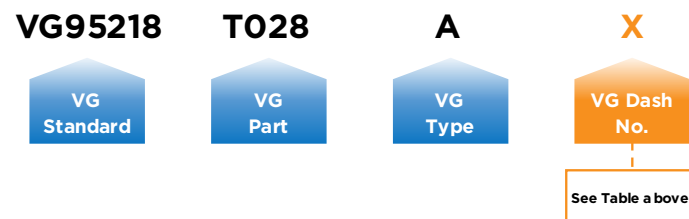

- Examples:
- VG95218T028A001 : 2 x 1.20mm² conductor, White, numbered & Overall Black Jacket
 - VG95218T028A011 : 7 x 2.00mm² conductor, 1 x Yellow, 2 x Blue, 4 x Grey component & Overall Black Jacket

VG 95218 Part 28 Type A



VG 95218 T028 A – Multi Core, Twisted Pairs, Double Overall Shielded & Jacketed Cable

- **Construction:** Multiple VG95218T021B pair elements, with overall wrap, double shield isolated with double wrap, and jacket
- **Conductor:** Stranded tin-coated copper - 0.40mm²
- **Insulation:** Polyalkene (Primary), PVDF (Primary jacket)
- **Wrap:** Polyester (Overall)
- **Shield Material/Type:** Tin-coated copper / Optimized Woven Shield
- **Overall Jacket:** Fuel & Diesel Resistant Elastomer - FDR25
- **Temperature Rating:** -40°C to +150°C
- **Voltage Rating:** 600V AC / 600V DC

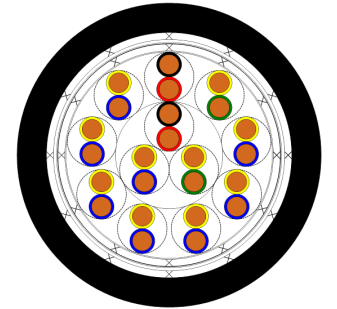

Illustrative Image - VG95218T028A007 example



Product Information Table

Part Description	No. of wires	No. of Wires x Cross Sectional Area (mm ²)	VG Dash No.	Component	Screen 1 - Strand Size		Screen 2 - Strand Size		Minimum Wall Thickness (mm)	FINISHED CABLE				
					AWG	Nom. (mm)	AWG	Nom. (mm)		Cable Diameter (mm)		Max. Weight (kg/km)	Max Resistance @ 20°C (Ohms/km)	Max. Transfer Impedance @ 30MHz (mOhms/m)
					Min.	Max.	Min.	Max.						
VG95218T028A007	24	12 x 2 x 0.40	007	VG95218T021B004	34	0.160	34	0.160	1.81	14.0	15.0	310	55.30	10
				VG95218T021B005										
				VG95218T021B006										
VG95218T028A008	54	27 x 2 x 0.40	008	VG95218T021B004	32	0.203	32	0.203	2.41	19.5	21.7	713	55.30	10
				VG95218T021B005										
				VG95218T021B006										

- NOTES:**
- VG descriptions in table are only available with a Black jacket.
 - Component/s for the above cables shall be as listed under "Component" column. e.g. Components for VG95218T028A007 shall be VG95218T021B004/005/006.
 - Fillers are used as required.
 - Values are for guidance only, refer to drawings for maintained product information.

TABLE COLOR KEY:

System 25
System 100
System 200

Component Identification

- 1st pair: Black, Red (Pilot and Direction)
- 2nd pair: Yellow, Green (Counting Direction)
- 3rd and following pairs: Yellow, Blue

Position of pair colors and direction applicable to every cable layer

Cable Jacket Identification

- The mark shall be: **Raychem - VG 95218 T028 A### - K1010 - VDE Reg.Nr. 9425** where: "###" = VG Dash No. e.g: VG95218T028A007 shall be marked: **Raychem - VG95218T028A007 - K1010 - VDE Reg.Nr. 9425**
- Color of mark shall be white.

VG Part Description

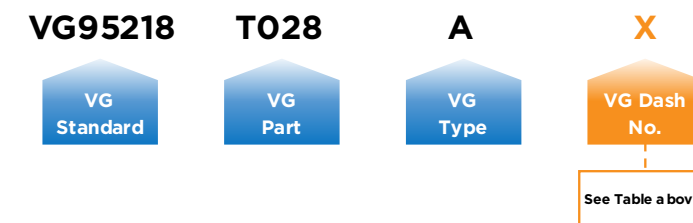

- Example:
- VG95218T028A007 : 24 x 2 x 0.40mm² conductor, 1st pair; Black, Red, 2nd pair; Yellow, Green, remaining pairs; Yellow, Blue

VG 95218 Part 28 Type A



VG 95218 T028 A – Multi Core, Shielded & Jacketed Twisted Triples, Double Overall Shielded & Jacketed Cable

- **Construction:** Multiple VG95218T023B triple elements with individual screens & jackets, with overall wrap, double shield isolated with double wrap, and jacket
- **Conductor:** Stranded tin-coated copper - 0.40mm²
- **Insulation:** Polyalkene (Primary), PVDF (Primary jacket)
- **Individual Jacket:** PVDF
- **Wrap:** Polyester (Overall)
- **Shield Material/Type:** Tin-coated copper / Optimized Woven Shield (Individual & Overall)
- **Overall Jacket:** Fuel & Diesel Resistant Elastomer - FDR25
- **Temperature Rating:** -40°C to +150°C
- **Voltage Rating:** 600V AC / 600V DC

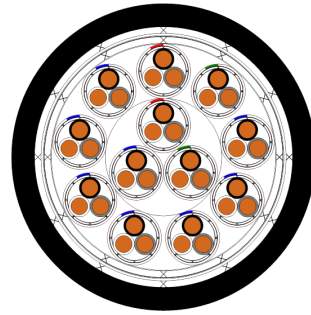

Illustrative Image - VG95218T028A010 example



Product Information Table

Part Description	No. of wires	No. of Wires x Cross Sectional Area (mm ²)	VG Dash No.	Component	Screen 1 - Strand Size		Screen 2 - Strand Size		Minimum Wall Thickness (mm)	FINISHED CABLE				
					AWG	Nom. (mm)	AWG	Nom. (mm)		Cable Diameter (mm)		Max. Weight (kg/km)	Max Resistance @ 20°C (Ohms/km)	Max. Transfer Impedance @ 30MHz (mOhms/m)
										Min.	Max.			
VG95218T028A009	15	5 x 3 x 0.40	009	VG95218T023B004	34	0.160	34	0.160	1.22	14.0	15.0	368	55.30	15
VG95218T028A010	36	12 x 3 x 0.40	010	VG95218T023B004	32	0.203	32	0.203	1.39	20.0	21.0	732	55.30	10

NOTES:

- VG descriptions in table are only available with a Black jacket.
- Component/s for the above cables shall be as listed under "Component" column. e.g. Components for VG95218T028A009 shall be VG95218T023B004.
- Fillers are used as required.
- Values are for guidance only, refer to drawings for maintained product information.

TABLE COLOR KEY:

- System 25
- System 100
- System 200

VG 95218 Part 28 Type A



VG 95218 T028 A – Multi Core, Shielded & Jacketed Twisted Triples, Double Overall Shielded & Jacketed Cable

Component Identification

Triple element component colors:

- Black, Grey, White

Triple element Jacket - Pilot & Direction identified by Jacket Stripe.

- 1st Triple: red stripe coding (pilot)
- 2nd Triple: green stripe coding (direction)
- 3rd and following triples: blue stripe coding

Pilot and direction colors are applicable to every cable layer.

Cable Jacket Identification

- The mark shall be: **Raychem - VG 95218 T028 A### - K1010 - VDE Reg.Nr. 9425** where: "###" = VG Dash No. e.g: VG95218T028A009 shall be marked: **Raychem - VG95218T028A009 - K1010 - VDE Reg.Nr. 9425**

- Color of mark shall be white.

VG Part Description

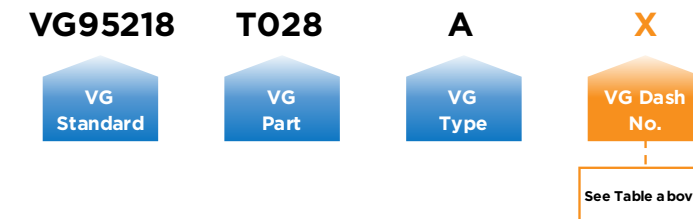

Example:

VG95218T028A009 : 5 x 3 x 0.40mm² conductor, 1st triple; Black, Grey White, Red Jacket Stripe, 2nd triple; Black, Grey White, Green, Jacket Stripe, remaining triples; Black, Grey White, Blue Jacket Stripe & Overall Black Jacket

VG 95218 Part 28 Type A



VG 95218 T028 A – Multi Core, Various components, Double Overall Shielded & Jacketed Cable

- **Construction:** Various VG95218T020A (Primaries), VG95218T021B (Pairs), VG95218T023B/VG95218T023F (Screened Jacketed Pairs), elements, with overall wrap, double shield and jacket
- **Conductor:** Stranded tin-coated copper - 0.15mm², 0.25mm², 0.60mm², 1.20mm²
- **Insulation:** Polyalkene (Primary), PVDF (Primary jacket), Polyethylene (Solid/Foamed Controlled Electrical Dielectric)
- **Individual Jacket:** PVDF, FDR25
- **Wrap:** Polyester (Overall)
- **Shield Material/Type:** Tin-coated copper / Optimized Woven Shield (Individual & Overall)
- **Element/Overall Jacket:** Fuel & Diesel Resistant Elastomer - FDR25

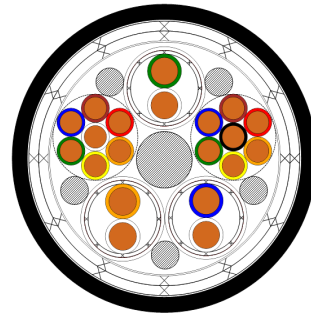

Illustrative Image - VG95218T028A012 example



Product Information Table

Part Description	No. of wires	No. of Wires x Cross Sectional Area (mm ²)	VG Dash No.	Component	Screen 1 - Strand Size		Screen 2 - Strand Size		Minimum Wall Thickness (mm)	FINISHED CABLE					
					AWG	Nom. (mm)	AWG	Nom. (mm)		Cable Diameter (mm)		Max. Weight (kg/km)	Max Resistance @ 20°C (Ohms/km)	Max. Transfer Impedance @ 30MHz (mOhms/m)	Voltage Rating (AC/DC)
										Min.	Max.				
VG95218T028A002	14	1 x 0.60	002	VG95218T020A003	34	0.160	34	0.160	1.09	14.2	15.8	440	34.20	5	600/900
		6 x 2 x 0.60		VG95218T023F002						34	34.90				
		1 x 1.20		VG95218T020A006							16.70				
VG95218T028A003	13	4 x 2 x 0.15	003	According to Table F.1	36	0.127	36	0.127	0.75	8.3	9.1	130	140.00	10	250/250
		5 x 0.25		VG95218T020A016							87.70				
VG95218T028A005	7	3 x 2 x 0.25	005	According to Table F.2	34	0.160	34	0.160	1.01	11.7	12.9	256	86.00	5	250/250
		1 x 0.60		VG95218T020A003							34.20				
VG95218T028A006	11	4 x 2 x 0.25	006	According to Table F.2	34	0.160	34	0.160	0.54	11.9	12.5	278	86.00	5	250/250
		3 x 0.60		VG95218T020A003							34.20				
VG95218T028A012	20	3 x 2 x 0.25	012	VG95218T023B006	34	0.160	34	0.160	0.37	10.3	11.3	240	89.50	5	600/600
				VG95218T023B007											
				VG95218T023B008											
				VG95218T021B007											
				VG95218T021B008											

- NOTES:**
- VG descriptions in table are only available with a Black jacket.
 - Component/s for the above cables shall be as listed under "Component" column. e.g. Components for VG95218T028A002 shall be VG95218T020A003, VG95218T023F002 & VG95218T020A006.
 - Fillers are used as required.
 - Values are for guidance only, refer to drawings for maintained product information.

TABLE COLOR KEY:

Yellow	System 25
Light Blue	System 100
Light Purple	System 200

VG 95218 Part 28 Type A



VG 95218 T028 A – Multi Core, Various components, Double Overall Shielded & Jacketed Cable

Component Identification

VG Dash No.- 002, 013:

- Primaries: White, numbered.
- Screened, Jacketed Pairs: White, numbered, White jacket.

VG Dash No.- 003:

- Primaries: White, numbered.
- Controlled Electrical Pairs: Natural/White.

VG Dash No.- 005:

- Primary: White, numbered.
- Controlled Electrical Screened, Jacketed Pairs: White, numbered, Black jacket.

VG Dash No.- 006:

- Primaries: Black, Red, Blue.
- Controlled Electrical Screened, Jacketed Pairs: White, numbered, Black jacket.

VG Dash No.- 012:

- Screened, Jacketed Pairs: Green, White, White jacket. Blue, White, White jacket. Orange, White, White jacket.
- 7 cores: Black, Brown, Red, Orange, Yellow, Green, Blue. White, Brown, Red, Orange, Yellow, Green, Blue.

Cable Jacket Identification

- The mark shall be: **Raychem - VG 95218 T028 A### - K1010 - VDE Reg.Nr. 9425** where: "###" = VG Dash No. e.g: VG95218T028A012 shall be marked: **Raychem - VG95218T028A012 - K1010 - VDE Reg.Nr. 9425**
- Color of mark shall be white.

VG Part Description

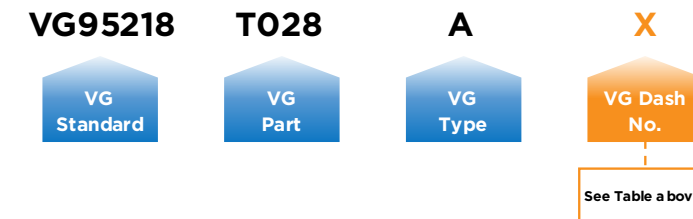

Examples:

- VG95218T028A003 : 4 x 2 x 0.15mm² & 5 x 0.25mm² conductors, 4x Pairs: Natural/White components, 5x Primaries: White, numbered components, Overall Black Jacket
- VG95218T028A006 : 4 x 2 x 0.25mm² & 3 x 0.60mm² conductors, 4x Screened, Jacketed Pairs: White, numbered components, Black Jacket & 3x Primaries: Black, Red, Blue components & Overall Black Jacket

VG 95218 Part 28 Type B



VG 95218 T028 B – Multi Core, Various components, Triple Overall Shielded & Jacketed Cable

- **Construction:** Multiple VG95218T023B pair elements with individual screens & jackets and M81044 single elements, with overall wrap, triple shield and jacket
- **Conductor:** Stranded tin-coated copper - 0.15mm², 1.20mm²
- **Insulation:** Polyalkene (Primary), PVDF (Primary jacket)
- **Individual Jacket:** PVDF
- **Wrap:** Polyester (Overall)
- **Shield Material/Type:** Tin-coated copper / Optimized Woven Shield (Individual), Tin-coated copper / Optimized Woven Shield, Metal foil, Optimized Woven Shield (Overall)
- **Overall Jacket:** Fuel & Diesel Resistant Elastomer - FDR25
- **Temperature Rating:** -40°C to +150°C
- **Voltage Rating:** 600V AC / 600V DC

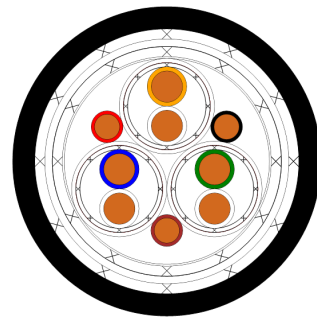

Illustrative Image - VG95218T028B002 example



Product Information Table

Part Description	No. of wires	No. of Wires x Cross Sectional Area (mm ²)	VG Dash No.	Component	Screen Strand Size		Minimum Wall Thickness (mm)	FINISHED CABLE				
					AWG	Nom. (mm)		Cable Diameter (mm)		Max. Weight (kg/km)	Max Resistance @ 20°C (Ohms/km)	Max. Transfer Impedance @ 30MHz (mOhms/m)
VG95218T028B001	4	2 x 2 x 1.20	001	VG95218T023B001	34	0.160	1.09	13.3	14.7	350	16.6	50
VG95218T028B002	9	1 x 2 x 0.15	002	VG95218T023B009	36	0.127	0.40	7.9	8.7	137	138.2	100
		1 x 2 x 0.15		VG95218T023B010								
		1 x 2 x 0.15		VG95218T023B011								
		3 x 0.15		M81044/12-26-9								

- NOTES:**
- VG descriptions in table are only available with a Black jacket.
 - Component/s for the above cables shall be as listed under "Component" column. e.g. Components for VG95218T028B001 shall be VG95218T023B001.
 - Fillers are used as required.
 - Values are for guidance only, refer to drawings for maintained product information.

TABLE COLOR KEY:

	System 25
	System 100
	System 200

VG 95218 Part 28 Type B



VG 95218 T028 B – Multi Core, Various components, Triple Overall Shielded & Jacketed Cable

Component Identification

VG Dash No.- 001:

- Screened, Jacketed Pairs: White, numbered, White jacket.

VG Dash No.- 002:

- Primaries: Black, Brown, Red.
- Screened, Jacketed Pairs: Green, White, White jacket.
Blue, White, White jacket.
Orange, White, White jacket.

Cable Jacket Identification

- The mark shall be: **Raychem - VG 95218 T028 B### - K1010 - VDE Reg.Nr. 9425** where: "###" = VG Dash No. e.g: VG95218T028B002 shall be marked: **Raychem - VG95218T028B002 - K1010 - VDE Reg.Nr. 9425**
- Color of mark shall be white.

VG Part Description

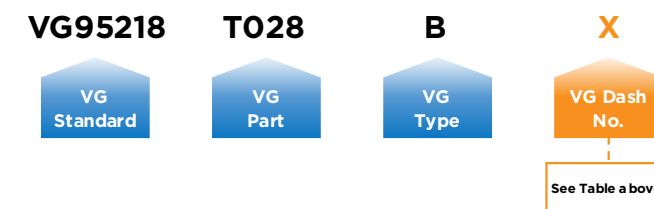

Example:
VG95218T028B001 : 2 x 2 x 1.20mm² conductor, 2 x Pairs, White, numbered with White Jackets & Overall Black Jacket

VG 95218 Part 28 Type C

VG 95218 T028 C (LMGSGO) - Multi Core, Primary Wires, Overall Shielded & Jacketed Cable

- **Construction:** Multiple VG95218T020E elements, with overall wrap, shield and jacket
- **Conductor:** Stranded tin-coated copper - 1.50mm² or 2.50mm²
- **Insulation:** Halogen Free Polymer (Primary & Primary jacket)
- **Wrap:** Polyester (Overall)
- **Shield Material/Type:** Tin-coated copper / Optimized Woven Shield
- **Overall Jacket:** Zerohal jacketing material
- **Temperature Rating:** -40°C to +105°C
- **Voltage Rating:** 600V AC / 900V DC

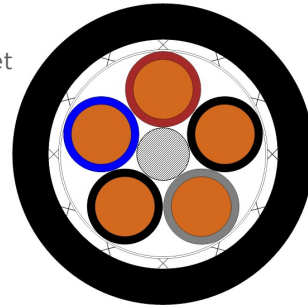

Illustrative Image - VG95218T028C090 example



Product Information Table

Part Description	No. of wires	No. of Wires x Cross Sectional Area (mm ²)	VG Dash No.	Component	Screen Strand Size		Minimum Wall Thickness (mm)	Cable Diameter (mm)		Max. Weight (kg/km)	Max Resistance @ 20°C (Ohms/km)	Max. Transfer Impedance (mOhms/m)	
					AWG	Nom. (mm)		Min.	Max.			@ 10MHz	@ 30MHz
VG95218T028C033	2	2 x 1.50	033 (Old)	VG95218T020E080	36	0.127	0.70	6.2	7.0	94	14.10	30	100
VG95218T020E086													
VG95218T028C083	2	2 x 1.50	083 (New)	VG95218T020E081	36	0.127	0.80	6.6	7.2	91	14.10	30	100
VG95218T020E086													
VG95218T028C093	2	2 x 1.50	093	VG95218T020E081	36	0.127	0.80	6.6	7.2	91	14.10	30	100
VG95218T020E086													
VG95218T028C035	3	3 x 1.50	035 (Old)	VG95218T020E080	36	0.127	0.70	6.5	7.3	105	14.10	30	100
VG95218T020E081													
VG95218T020E086													
VG95218T020E088													
VG95218T028C122	3	3 x 1.50	122 (New)	VG95218T020E080	36	0.127	0.80	6.9	7.5	111	14.10	30	100
VG95218T020E081													
VG95218T020E088													
VG95218T020E088													
VG95218T028C095	3	3 x 1.50	095	VG95218T020E080	36	0.127	0.80	6.9	7.5	111	14.10	30	100
VG95218T020E081													
VG95218T020E088													
VG95218T020E088													
VG95218T028C042	4	4 x 1.50	042 (Old)	2 x VG95218T020E080	34	0.160	0.70	7.1	7.9	135	14.10	30	100
1 x VG95218T020E081													
1 x VG95218T020E086													
VG95218T020E086													
VG95218T028C088	4	4 x 1.50	088 (New)	VG95218T020E081	34	0.160	0.70	7.1	7.9	135	14.10	30	100
VG95218T020E081													
VG95218T020E080													
VG95218T020E088													
VG95218T028C100	4	4 x 1.50	100	VG95218T020E080	34	0.160	0.75	7.4	8.0	137	14.10	30	100
VG95218T020E081													
VG95218T020E086													
VG95218T020E088													

NOTES:

- VG descriptions in table are only available with a black jacket.
- Component/s for the above cables shall be as listed under "Component" column. e.g. Component for VG95218T028C046 shall be VG95218T020E089.
- Fillers are used as required.
- Values are for guidance only, refer to drawings for maintained product information.

TABLE COLOR KEY:

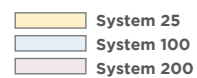

VG 95218 Part 28 Type C

VG 95218 T028 C (LMGSGO) - Multi Core, Primary Wires, Overall Shielded & Jacketed Cable

Product Information Table (Continued)

Part Description	No. of wires	No. of Wires x Cross Sectional Area (mm ²)	VG Dash No.	Component	Screen Strand Size		Minimum Wall Thickness (mm)	Cable Diameter (mm)		Max. Weight (kg/km)	Max Resistance @ 20°C (Ohms/km)	Max. Transfer Impedance (mOhms/m)	
					AWG	Nom. (mm)		Min.	Max.			@ 10MHz	@ 30MHz
VG95218T028C044	5	5 x 1.50	044 (Old)	3 x VG95218T020E080	36	0.127	0.70	7.6	8.4	156	14.10	30	100
1 x VG95218T020E081													
1 x VG95218T020E086													
VG95218T028C090	5	5 x 1.50	090 (New)	VG95218T020E086	36	0.127	0.70	7.6	8.4	156	14.10	30	100
VG95218T020E081													
2 VG95218T020E080													
VG95218T020E088													
VG95218T028C102	5	5 x 1.50	102	2 VG95218T020E080	36	0.127	0.80	8.0	8.6	154	14.10	30	100
1 VG95218T020E081													
1 VG95218T020E086													
1 VG95218T020E088													
VG95218T028C046	7	7 x 1.50	046	VG95218T020E089	36	0.127	0.70	8.2	9.0	196	14.10	30	70
VG95218T028C003	10	10 x 1.50	003	VG95218T020E089	34	0.160	0.79	11.0	11.6	277	14.60	30	45
VG95218T028C052	10	10 x 1.50	052	VG95218T020E089	34	0.160	0.80	10.5	11.7	275	14.10	30	45
VG95218T028C055	12	12 x 1.50	055	VG95218T020E089	34	0.160	0.80	10.8	12.8	309	14.60	30	45
VG95218T028C058	14	14 x 1.50	058	VG95218T020E089	34	0.160	0.80	11.3	12.5	358	14.60	30	45
VG95218T028C060	16	16 x 1.50	060	VG95218T020E089	34	0.160	0.80	11.9	13.1	402	14.60	30	45
VG95218T028C061	19	19 x 1.50	061	VG95218T020E089	34	0.160	0.80	12.5	13.7	456	15.00	30	45
VG95218T028C065	24	24 x 1.50	065	VG95218T020E089	32	0.203	0.70	15.3	16.1	585	14.10	30	30
VG95218T028C066	27	27 x 1.50	066	VG95218T020E089	32	0.203	0.80	15.0	16.6	640	14.10	30	30
VG95218T028C070	33	33 x 1.50	070	VG95218T020E089	32	0.203	0.90	15.8	17.6	760	14.10	30	30
VG95218T028C005	37	37 x 1.50	005	VG95218T020E089	32	0.203	1.00	18.2	19.2	868	14.60	30	30
VG95218T028C036	3	3G x 1.50	036 (Old)	VG95218T020E080	36	0.127	0.70	6.5	7.3	105	14.10	30	100
VG95218T020E086													
VG95218T020E08G													
VG95218T020E08G													
VG95218T028C085	3	3G x 1.50	085 (New)	VG95218T020E086	36	0.127	0.80	6.9	7.5	108	14.10	30	100
VG95218T020E081													
VG95218T020E081													
VG95218T020E081													
VG95218T028C096	3	3G x 1.50	096	VG95218T020E086	36	0.127	0.80	6.9	7.5	108	14.10	30	100
VG95218T020E086													
VG95218T020E08G													
VG95218T028C045	5	5G x 1.50	045 (Old)	2 x VG95218T020E080	36	0.127	0.70	7.6	8.4	156	14.10	30	100
1 x VG95218T020E081													
1 x VG95218T020E086													
1 x VG95218T020E08G													
VG95218T028C091	5	5G x 1.50	091 (New)	VG95218T020E08G	36	0.127	0.70	7.6	8.4	156	14.10	30	100
VG95218T020E086													
VG95218T020E081													
VG95218T020E080													
VG95218T020E088													

NOTES:

- VG descriptions in table are only available with a black jacket.
- Component/s for the above cables shall be as listed under "Component" column. e.g. Component for VG95218T028C046 shall be VG95218T020E089.
- Fillers are used as required.
- Values are for guidance only, refer to drawings for maintained product information.

TABLE COLOR KEY:

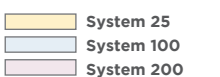

VG 95218 Part 28 Type C



VG 95218 T028 C (LMGSGO) - Multi Core, Primary Wires, Overall Shielded & Jacketed Cable

Product Information Table (Continued)

Part Description	No. of wires	No. of Wires x Cross Sectional Area (mm ²)	VG Dash No.	Component	Screen Strand Size		Minimum Wall Thickness (mm)	Cable Diameter (mm)		Max. Weight (kg/km)	Max Resistance @ 20°C (Ohms/km)	Max. Transfer Impedance (mOhms/m)	
					AWG	Nom. (mm)		Min.	Max.			@ 10MHz	@ 30MHz
VG95218T028C103	5	5G x 1.50	103	VG95218T020E080	36	0.127	0.80	8.0	8.6	154	14.10	30	100
				VG95218T020E081									
				VG95218T020E086									
				VG95218T020E088									
				VG95218T020E08G									
VG95218T028C047	7	7G x 1.50	047	6 VG95218T020E080	36	0.127	0.70	8.0	8.8	196	14.10	30	70
				1 VG95218T020E08G									
VG95218T028C053	10	10G x 1.50	053	9 VG95218T020E080	34	0.160	0.80	10.5	11.5	281	14.60	30	45
				1 VG95218T020E08G									
VG95218T028C034	2	2 x 2.50	034 (Old)	VG95218T020E100	36	0.127	0.70	7.1	7.9	126	8.46	30	100
				VG95218T020E106									
VG95218T028C084			084 (New)	VG95218T020E101	36	0.127	0.70	7.1	7.9	126	8.46	30	100
				VG95218T020E106									
VG95218T028C094	2	2 x 2.50	094	VG95218T020E101	36	0.127	0.80	7.5	8.1	127	8.46	30	100
				VG95218T020E106									
VG95218T028C037	3	3 x 2.50	037 (Old)	VG95218T020E100	36	0.127	0.70	7.5	8.3	151	8.46	30	100
				VG95218T020E101									
				VG95218T020E106									
				VG95218T020E101									
				VG95218T020E101									
VG95218T028C086			086 (New)	VG95218T020E100	36	0.127	0.70	7.5	8.3	151	8.46	30	100
				VG95218T020E101									
				VG95218T020E108									
				VG95218T020E108									
VG95218T028C097	3	3 x 2.50	097	VG95218T020E100	36	0.127	0.80	7.9	8.5	152	8.46	30	100
				VG95218T020E101									
				VG95218T020E108									
VG95218T028C043	4	4 x 2.50	043 (Old)	2 x VG95218T020E100	36	0.127	0.70	8.2	9.0	186	8.46	30	70
				1 x VG95218T020E101									
				1 x VG95218T020E106									
				VG95218T020E106									
VG95218T028C089			089 (New)	VG95218T020E101	36	0.127	0.70	8.2	9.0	186	8.46	30	70
				VG95218T020E100									
				VG95218T020E108									
				VG95218T020E108									
VG95218T028C101	4	4 x 2.50	101	VG95218T020E100	36	0.127	0.75	8.5	9.1	186	8.46	30	100
				VG95218T020E101									
				VG95218T020E106									
				VG95218T020E108									
VG95218T028C048	7	7 x 2.50	048	VG95218T020E109	34	0.160	0.70	9.6	10.8	278	8.46	30	45
				VG95218T020E100									
VG95218T028C038	3	3G x 2.50	038 (Old)	VG95218T020E100	36	0.127	0.70	7.5	8.3	151	8.46	30	100
				VG95218T020E106									
				VG95218T020E10G									
				VG95218T020E10G									
VG95218T028C087			087 (New)	VG95218T020E106	36	0.127	0.70	7.5	8.3	151	8.46	30	100
				VG95218T020E101									
				VG95218T020E101									
VG95218T028C098	3	3G x 2.50	098	VG95218T020E101	36	0.127	0.80	7.9	8.5	132	8.46	30	100
				VG95218T020E106									
				VG95218T020E10G									

NOTES:

- VG descriptions in table are only available with a black jacket.
- Component/s for the above cables shall be as listed under "Component" column. e.g. Component for VG95218T028C046 shall be VG95218T020E089.
- Fillers are used as required.
- Values are for guidance only, refer to drawings for maintained product information.

TABLE COLOR KEY:

	System 25
	System 100
	System 200

VG 95218 Part 28 Type C



VG 95218 T028 C (LMGSGO) - Multi Core, Primary Wires, Overall Shielded & Jacketed Cable

Component Identification

Cables with green/yellow earth wire:

- 3-wire: blue, brown, green/yellow **or** blue, black, green/yellow
- 5-wire: blue, brown, black, grey, green/yellow **or** 2x black, blue, brown, green/yellow
- 7 to 10-wire: green/yellow (in outer layer), all other black with white numbers, counting from the center towards the outside

Cables without green/yellow earth wire:

- 2-wire: black, blue **or** brown, blue
- 3-wire: black, blue, brown **or** black, brown, grey
- 4-wire: black, grey, blue, brown **or** 2x black, brown, blue
- 5-wire: 2x black, grey, blue, brown **or** 3x black, blue, brown
- 7-wire and more: white with black numbers, counting from the center towards the outside

Cable Jacket Identification

- The mark shall be: **Raychem - VG 95218 T028 C### - K1010 - VDE Reg.Nr. 7095 - LMGSGO - (XXX)**
 where: "###" = VG Dash No.
 where: "XXX" = No. of Wires x Cross Sectional Area(mm²)
 e.g: VG95218T028C048 shall be marked: Raychem - **VG95218T028C048 - K1010 - VDE Reg.Nr. 7095 - LMGSGO - (7x2.5)**
- Color of mark shall be white.

VG Part Description

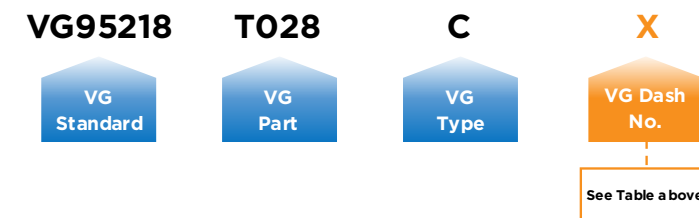

Examples:

- VG95218T028C033 : 2 x 1.50mm² conductors, Black, Blue components & Overall Black Jacket
- VG95218T028C048 : 7 x 2.50mm² conductors, White + Numbered components & Overall Black Jacket
- VG95218T028C053 : 10 x 2.50mm² conductors, 1x Green/Yellow, 9x Black + Numbered components & Overall Black Jacket

VG 95218 Part 28 Type C



VG 95218 T028 C (LFMGSGO) – Multi Core, Twisted Pairs, Overall Shielded & Jacketed Cable

- **Construction:** Multiple VG95218T021C pair elements, with overall wrap, shield and jacket
- **Conductor:** Stranded tin-coated copper - 0.15mm², 0.40mm²
- **Insulation:** Halogen Free Polymer (Primary & Primary jacket)
- **Wrap:** Polyester (Overall)
- **Shield Material/Type:** Tin-coated copper / Optimized Woven Shield
- **Overall Jacket:** Zerohal jacketing material
- **Temperature Rating:** -40°C to +105°C
- **Voltage Rating:** 600V AC / 900V DC

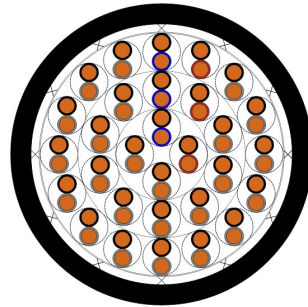

Illustrative Image - VG95218T028C76 example



Product Information Table

Part Description	No. of wires	No. of Wires x Cross Sectional Area (mm ²)	VG Dash No.	Component	Screen Strand Size		Minimum Wall Thickness (mm)	Cable Diameter (mm)		Max. Weight (kg/km)	Max Resistance @ 20°C (Ohms/km)	Max. Transfer Impedance (mOhms/m)	
					AWG	Nom. (mm)		Min.	Max.			@ 10MHz	@ 30MHz
VG95218T028C076	60	30 x 2 x 0.40	076	3 VG95218T021C039	32	0.203	0.90	15.5	17.1	493	57	30	30
				3 VG95218T021C038									
				24 VG95218T021C040									
VG95218T028C077	90	45 x 2 x 0.40	077	4 VG95218T021C039	32	0.203	0.90	18.8	20.8	699	57	30	30
				4 VG95218T021C038									
				37 VG95218T021C040									
VG95218T028C030	120	60 x 2 x 0.15	030	VG95218T021C034	32	0.203	1.00	18.6	20.6	582	150	30	50
VG95218T028C120	120	60 x 2 x 0.15	120	4 VG95218T021C049	32	0.203	1.70	19.5	21.5	643	150	30	50
				4 VG95218T021C050									
				52 VG95218T021C051									

NOTES:

- VG descriptions in table are only available with a Black jacket.
- Component/s for the above cables shall be as listed under "Component" column. e.g. Components for VG95218T028C030 shall be VG95218T021C034.
- Fillers are used as required.
- Values are for guidance only, refer to drawings for maintained product information.

TABLE COLOR KEY:

- System 25
- System 100
- System 200

VG 95218 Part 28 Type C



VG 95218 T028 C (LFMGSGO) – Multi Core, Twisted Pairs, Overall Shielded & Jacketed Cable

Component Identification

VG Dash No.- 030:

Pair element component colors - Pilot & Direction:

- All Pairs: White, numbered.

VG Dash No.- 076, 077, 120:

Pair element component colors - Pilot & Direction:

- 1st Pair: Black, Blue coding (Pilot)
 - 2nd Pair: Black, Brown coding (Direction)
 - 3rd and subsequent Pairs: Black, Grey coding
- Pilot and direction colors are applicable to every cable layer.

Cable Jacket Identification

- The mark shall be: **Raychem - VG 95218 T028 C### - K1010 - VDE Reg.Nr. 7095 - LFMGSGO - (XXX)**
 where: "###" = VG Dash No.
 where: "XXX" = No. of Wires x Cross Sectional Area(mm²)
 e.g: VG95218T028C076 shall be marked: **Raychem - VG95218T028C076 - K1010 - VDE Reg.Nr. 7095 - LFMGSGO - (30x2x0.4)**

VG Part Description

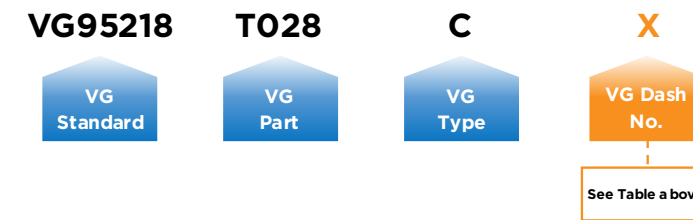

Examples:

- VVG95218T028C076: 30 x 2 x 0.40mm² conductors, 3x Pairs: Black, Blue, 3x Pairs: Black, Brown, 24x Pairs: Black, Grey components & Overall Black Jacket
- VG95218T028C077 : 45 x 2 x 0.40mm² conductors, 4x Pairs: Black, Blue, 4x Pairs: Black, Brown, 37x Pairs: Black, Grey components & Overall Black Jacket

VG 95218 Part 28 Type C



VG 95218 T028 C (LFMGSGO) – Multi Core, Twisted Triples, Overall Shielded & Jacketed Cable

- **Construction:** Multiple wrapped VG95218T021C045 triple elements, with overall wrap, shield and jacket
- **Conductor:** Stranded tin-coated copper - 0.40mm²
- **Insulation:** Halogen Free Polymer (Primary & Primary jacket)
- **Wrap:** Polyester (Element & Overall)
- **Shield Material/Type:** Tin-coated copper / Optimized Woven Shield
- **Overall Jacket:** Zerohal jacketing material
- **Temperature Rating:** -40°C to +105°C
- **Voltage Rating:** 600V AC / 900V DC

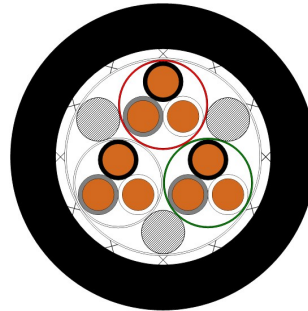

Illustrative Image - VG95218T028C105 example



Product Information Table

Part Description	No. of wires	No. of Wires x Cross Sectional Area (mm ²)	VG Dash No.	Component	Screen Strand Size		Minimum Wall Thickness (mm)	Cable Diameter (mm)		Max. Weight (kg/km)	Max Resistance @ 20°C (Ohms/km)	Max. Transfer Impedance (mOhms/m)	
					AWG	Nom. (mm)		Min.	Max.			@ 10MHz	@ 30MHz
VG95218T028C105	9	3 x 3 x 0.40	105	3 VG95218T021C045	36	0.127	1.00	8.8	9.6	139	52	30	100
VG95218T028C107	15	5 x 3 x 0.40	107	5 VG95218T021C045	36	0.127	0.70	9.5	10.5	173	52	30	100
VG95218T028C110	21	7 x 3 x 0.40	110	7 VG95218T021C045	34	0.160	0.70	10.8	12.0	232	52	30	50
VG95218T028C112	30	10 x 3 x 0.40	112	10 VG95218T021C045	34	0.160	0.75	13.9	15.3	324	52	30	50
VG95218T028C114	36	12 x 3 x 0.40	114	12 VG95218T021C045	34	0.160	0.75	14.2	15.8	352	52	30	50
VG95218T028C115	42	14 x 3 x 0.40	115	14 VG95218T021C045	32	0.203	0.75	15.1	16.7	421	52	30	50
VG95218T028C116	57	19 x 3 x 0.40	116	19 VG95218T021C045	32	0.203	0.75	16.6	18.4	523	52	30	50
VG95218T028C117	72	24 x 3 x 0.40	117	24 VG95218T021C045	32	0.203	0.85	18.8	20.8	619	52	30	50
VG95218T028C118	90	30 x 3 x 0.40	118	30 VG95218T021C045	32	0.203	0.85	19.9	21.9	723	52	30	50
VG95218T028C119	111	37 x 3 x 0.40	119	37 VG95218T021C045	30	0.254	0.85	21.7	23.9	891	52	30	50
VG95218T028C121	132	44 x 3 x 0.40	121	44 VG95218T021C045	28	0.330	0.90	24.7	27.1	1114	52	30	50

NOTES:

- VG descriptions in table are only available with a black jacket.
- Component/s for the above cables shall be as listed under "Component" column. e.g. Components for VG95218T028C105 shall be VG95218T021C045.
- Fillers are used as required.
- Values are for guidance only, refer to drawings for maintained product information.

TABLE COLOR KEY:

	System 25
	System 100
	System 200

VG 95218 Part 28 Type C



VG 95218 T028 C (LFMGSGO) – Multi Core, Twisted Triples, Overall Shielded & Jacketed Cable

Component Identification

Triple element component colors:

- Black, White, Grey

Triple element wrap - Pilot & Direction identified by wrap color:

- 1st Triple: red wrap coding (pilot)
 - 2nd Triple: green wrap coding (direction)
 - 3rd and subsequent triples: transparent wrap coding
- Pilot and direction colors are applicable to every cable layer.

VG Part Description

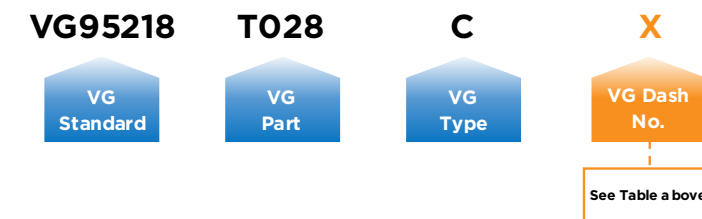

Examples:

- VG95218T028C105: 3 x 3 x 0.40mm² conductors, Black, White, Grey components + Coloured wrap & Overall Black Jacket
- VG95218T028C121: 44 x 3 x 0.40mm² conductors, Black, White, Grey components + Coloured wrap & Overall Black Jacket

VG 95218 Part 28 Type C



VG 95218 T028 C (FMSGSGO) – Multi Core, Shielded & Wrapped Twisted Pairs, Overall Shielded & Jacketed Cable

- **Construction:** Multiple VG95218T023G pair elements, with individual screens & wraps, overall wrap, shield and jacket
- **Conductor:** Stranded tin-coated copper - 0.75mm²
- **Insulation:** Halogen Free Polymer (Primary & Primary jacket)
- **Wrap:** Polyester (Individual & Overall)
- **Shield Material/Type:** Tin-coated copper / Optimized Woven Shield
- **Overall Jacket:** Zerohal jacketing material
- **Temperature Rating:** -40°C to +105°C
- **Voltage Rating:** 600V AC / 900V DC

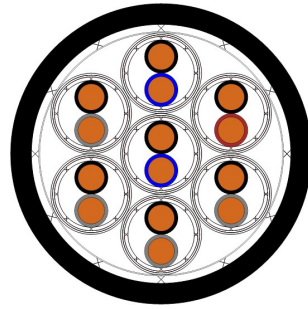

Illustrative Image - VG95218T028C057 example



Product Information Table

Part Description	No. of wires	No. of Wires x Cross Sectional Area (mm ²)	VG Dash No.	Component	Screen Strand Size		Minimum Wall Thickness (mm)	Cable Diameter (mm)		Max. Weight (kg/km)	Max Resistance @ 20°C (Ohms/km)	Max. Transfer Impedance (mOhms/m)	
					AWG	Nom. (mm)		Min.	Max.			@ 10MHz	@ 30MHz
VG95218T028C041	4	2 x 2 x 0.75	041	VG95218T023G007	36	0.127	0.70	9.5	10.5	165	28.4	30	45
				VG95218T028C041									
VG95218T028C051	8	4 x 2 x 0.75	051	1 VG95218T023G008	34	0.160	0.80	10.9	11.9	249	28.4	30	45
				VG95218T028C051									
				VG95218T028C051									
VG95218T028C057	14	7 x 2 x 0.75	057	2 VG95218T023G008	34	0.160	0.80	13.0	14.2	355	30.5	30	45
				VG95218T028C057									
				VG95218T028C057									
VG95218T028C063	22	11 x 2 x 0.75	063	2 VG95218T023G008	32	0.203	0.90	16.1	17.9	570	30.5	30	30
				VG95218T028C063									
				VG95218T028C063									
VG95218T028C068	28	14 x 2 x 0.75	068	2 VG95218T023G008	32	0.203	0.90	17.1	18.9	660	30.5	30	30
				VG95218T028C068									
				VG95218T028C068									
VG95218T028C072	38	19 x 2 x 0.75	072	3 VG95218T023G008	32	0.203	0.90	19.5	21.5	872	30.5	30	30
				VG95218T028C072									
				VG95218T028C072									
VG95218T028C074	48	24 x 2 x 0.75	074	3 VG95218T023G008	32	0.203	1.00	21.7	24.1	1068	30.5	30	30
				VG95218T028C074									
				VG95218T028C074									

NOTES:

- VG descriptions in table are only available with a Black jacket.
- Component/s for the above cables shall be as listed under "Component" column.
e.g. Components for VG95218T028C057 shall be VG95218T023G007, VG95218T023G008 & VG95218T023G009.
- Fillers are used as required.
- Values are for guidance only, refer to drawings for maintained product information.

TABLE COLOR KEY:

- System 25
- System 100
- System 200

VG 95218 Part 28 Type C



VG 95218 T028 C (FMSGSGO) – Multi Core, Shielded & Wrapped Twisted Pairs, Overall Shielded & Jacketed Cable

Component Identification

2-pair cable

- 1st pair: Black, Blue
- 2nd pair: Black, Brown

4 to 24-pair cable

- 1st pair: Black, Blue (Pilot and Direction)
- 2nd pair: Black, Brown (Counting Direction)
- 3rd and following pairs: Black, Grey

Position of pair colors and direction applicable to every cable layer

Cable Jacket Identification

- The mark shall be: **Raychem - VG 95218 T028 C### - K1010 - VDE Reg.Nr. 7095 - FMSGSGO - (XXX)**
where: "###" = VG Dash No.
where: "XXX" = No. of Wires x Cross Sectional Area (mm²)
e.g: VG95218T028C057 shall be marked: **Raychem - VG95218T028C057 - K1010 - VDE Reg.Nr. 7095 - FMSGSGO - (7x2x0.75)**

- Color of mark shall be white.

VG Part Description

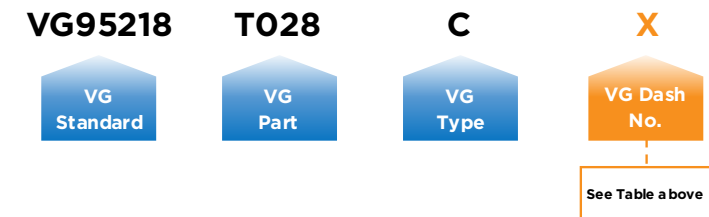

Examples:

- VG95218T028C041 : 2 x 2 x 0.75mm² conductors, 1st pair; Black, Blue & 2nd pair; Black, Brown & Overall Black Jacket
- VG95218T028C074 : 24 x 2 x 0.75mm² conductors, 1st pair; Black, Blue, 2nd pair; Black, Brown, remaining pairs; Black, Grey & Overall Black Jacket

VG 95218 Part 28 Type C



VG 95218 T028 C (FMGSGO) – Multi Core, Twisted Pairs or Quads, Overall Shielded & Jacketed Cable

- **Construction:** Multiple VG95218T021C elements, with overall wrap, shield and jacket (Note - 1 pair construction contains 2x VG95218T020E elements)
- **Conductor:** Stranded tin-coated copper - 0.75mm² or 1.00mm²
- **Insulation:** Halogen Free Polymer (Primary & Primary jacket)
- **Wrap:** Polyester (Overall)
- **Shield Material/Type:** Tin-coated copper / Optimized Woven Shield
- **Overall Jacket:** Zerohal jacketing material
- **Temperature Rating:** -40°C to +105°C
- **Voltage Rating:** 600V AC / 900V DC

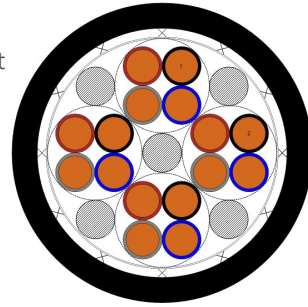

Illustrative Image - VG95218T028C059 example



Product Information Table

Part Description	No. of wires	No. of Wires x Cross Sectional Area (mm ²)	VG Dash No.	Component	Screen Strand Size		Minimum Wall Thickness (mm)	Cable Diameter (mm)		Max. Weight (kg/km)	Max Resistance @ 20°C (Ohms/km)	Max. Transfer Impedance (mOhms/m)	
					AWG	Nom. (mm)		Min.	Max.			@ 10MHz	@ 30MHz
VG95218T028C032	2	1 x 2 x 0.75	032 (Old)	VG95218T020E050	36	0.127	0.70	5.2	5.6	57	30.5	30	100
VG95218T028C082			082 (New)	VG95218T020E051									
VG95218T028C040	4	2 x 2 x 0.75	040	VG95218T021C048	36	0.127	0.70	5.7	6.3	79	28.4	30	100
VG95218T028C050	8	4 x 2 x 0.75	050	1 VG95218T021C042	34	0.160	0.70	8.7	9.7	162	28.4	30	70
			050	1 VG95218T021C041									
			050	2 VG95218T021C043									
VG95218T028C054	12	6 x 2 x 0.75	054	3 VG95218T021C048	34	0.160	0.80	10.1	11.3	225	30.5	30	45
VG95218T028C059	16	8 x 2 x 0.75	059	4 VG95218T021C048	34	0.160	0.80	11.0	12.0	269	30.5	30	45
VG95218T028C062	20	10 x 2 x 0.75	062	5 VG95218T021C048	32	0.203	0.80	12.2	13.4	341	30.5	30	30
VG95218T028C067	28	14 x 2 x 0.75	067	7 VG95218T021C048	34	0.160	0.80	13.0	14.4	402	30.5	30	45
VG95218T028C069	32	16 x 2 x 0.75	069	8 VG95218T021C048	32	0.203	0.80	14.4	15.8	479	30.5	30	30
VG95218T028C092	2	1 x 2 x 1.00	092	VG95218T021C054	36	0.127	0.80	5.7	6.3	69	21.4	30	100
VG95218T028C099	4	2 x 2 x 1.00	099	VG95218T021C055	36	0.127	0.80	6.5	7.1	93	21.4	30	100
VG95218T028C104	8	4 x 2 x 1.00	104	1 VG95218T021C052	36	0.127	1.30	11.5	12.7	237	21.4	30	50
			1 VG95218T021C053										
			2 VG95218T021C054										
VG95218T028C106	12	6 x 2 x 1.00	106	1 VG95218T021C056	34	0.160	0.70	10.7	11.9	251	21.4	30	50
			1 VG95218T021C057										
			1 VG95218T021C055										
VG95218T028C108	16	8 x 2 x 1.00	108	1 VG95218T021C056	34	0.160	0.75	11.9	13.1	322	21.4	30	50
			1 VG95218T021C057										
			2 VG95218T021C055										
VG95218T028C109	20	10 x 2 x 1.00	109	1 VG95218T021C056	34	0.160	0.75	13.0	14.4	389	21.4	30	50
			1 VG95218T021C057										
			3 VG95218T021C055										
VG95218T028C111	28	14 x 2 x 1.00	111	1 VG95218T021C056	32	0.203	0.75	14.3	15.9	506	21.4	30	50
			1 VG95218T021C057										
			5 VG95218T021C055										
VG95218T028C113	32	16 x 2 x 1.00	113	1 VG95218T021C056	32	0.203	0.85	17.3	19.1	641	21.4	30	50
			1 VG95218T021C057										
			6 VG95218T021C055										

NOTES:

- VG descriptions in table are only available with a Black jacket.
- Component/s for the above cables shall be as listed under "Component" column. e.g. Components for VG95218T028C050 shall be VG95218T021C041, VG95218T021C042 & VG95218T021C043.
- Fillers are used as required.
- Values are for guidance only, refer to drawings for maintained product information.

TABLE COLOR KEY:

System 25
System 100
System 200

VG 95218 Part 28 Type C



VG 95218 T028 C (FMGSGO) – Multi Core, Twisted Pairs or Quads, Overall Shielded & Jacketed Cable

Component Identification

1-pair cable (1 pair = 2 Primary wires)

- Black, Blue

2-pair cable (2 pairs = 1 Star Quad)

- Black, Blue, Grey, Brown (Black and Grey opposite each other)

4-pair cable

- 1st pair: Black, Blue
- 2nd pair: Black, Brown
- 3rd pair: Black, Grey
- 4th pair: Black, Grey

6 to 16-pair cable (3 to 8 Star Quads)

- Each star quad: Black, Blue, Grey, Brown (Black and Grey opposite each other). First and second Star Quad are number marked "1" and "2" respectively. (Black component only)

Cable Jacket Identification

- The mark shall be: **Raychem - VG 95218 T028 C### - K1010 - VDE Reg.Nr. 7095 - FMGSGO - (XXX)** where: "###" = VG Dash No. where: "XXX" = No. of Wires x Cross Sectional Area (mm²) e.g: VG95218T028C113 shall be marked: **Raychem - VG95218T028C113 - K1010 - VDE Reg.Nr. 7095 - FMGSGO - (16x2x1.0)**

- Color of mark shall be white.

VG Part Description

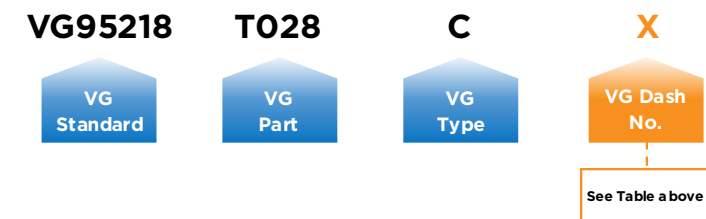

Examples:

- VG95218T028C082 : 2 x 0.75mm² conductors, Black, Blue components & Overall Black Jacket
- VG95218T028C113 : 16 x 2 x 1.00mm² conductors (8 x Star Quads), Black, Blue, Grey, Brown + Numbered black component on 1st/2nd Star Quad & Overall Black Jacket

VG 95218 Part 28 Type C



VG 95218 T028 C (LFMSGSGO) – Multi Core, Shielded & Wrapped Twisted Pairs/Quads, Overall Shielded & Jacketed Cable

- **Construction:** Multiple VG95218T023G pair/quad elements, with individual screens & wraps, overall wrap, shield and jacket
- **Conductor:** Stranded tin-coated copper - 0.25mm², 0.40mm², 1.20mm²
- **Insulation:** Halogen Free Polymer (Primary & Primary jacket)
- **Wrap:** Polyester (Individual & Overall)
- **Shield Material/Type:** Tin-coated copper / Optimized Woven Shield
- **Overall Jacket:** Zerohal jacketing material
- **Temperature Rating:** -40°C to +105°C
- **Voltage Rating:** 600V AC / 900V DC

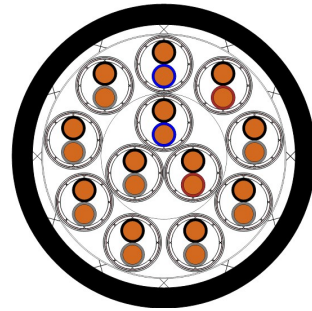

Illustrative Image - VG95218T028C064 example



Product Information Table

Part Description	No. of wires	No. of Wires x Cross Sectional Area (mm ²)	VG Dash No.	Component	Screen Strand Size		Minimum Wall Thickness (mm)	FINISHED CABLE					
					AWG	Nom. (mm)		Cable Diameter (mm)		Max. Weight (kg/km)	Max Resistance @ 20°C (Ohms/km)	Max. Transfer Impedance (mOhms/m)	
								Min.	Max.			@ 10MHz	@ 30MHz
VG95218T028C039	4	2 x 2 x 0.40	039	VG95218T023G004	36	0.127	0.70	8.3	9.1	125	53.0	30	70
				VG95218T023G005									
VG95218T028C049	8	4 x 2 x 0.40	049	1 VG95218T023G005	34	0.160	0.70	9.3	10.3	178	53.0	30	45
				1 VG95218T023G004									
VG95218T028C056	14	7 x 2 x 0.40	056	2 VG95218T023G005	34	0.160	0.80	11.3	12.3	263	56.0	30	45
				1 VG95218T023G004									
VG95218T028C064	24	12 x 2 x 0.40	064	2 VG95218T023G005	32	0.203	0.80	13.7	15.1	407	56.0	30	30
	24	12 x 2 x 0.40	064	2 VG95218T023G004									
	24	12 x 2 x 0.40	064	8 VG95218T023G006									
VG95218T028C071	38	19 x 2 x 0.40	071	3 VG95218T023G005	32	0.203	0.90	16.8	18.6	603	56.0	30	30
				2 VG95218T023G004									
				14 VG95218T023G006									
VG95218T028C075	54	27 x 2 x 0.40	075	3 VG95218T023G005	32	0.203	0.90	19.4	21.4	806	56.0	30	30
				3 VG95218T023G004									
				21 VG95218T023G006									
VG95218T028C073	42	3 x 2 x 1.20	073	VG95218T023G010	32	0.203	0.90	17.8	19.6	624	16.0	30	30
				VG95218T023G011									
				VG95218T023G012									
		2 VG95218T023G001		90.0									
		2 VG95218T023G002											
14 VG95218T023G003	30												
3 VG95218T023G017		30											
3 VG95218T023G018	30												
21 VG95218T023G016		30											
VG95218T028C078	108		27 x 4 x 0.25	108	3 VG95218T023G018	32	0.203	1.00	21.6	23.8	1008	56.0	30

NOTES:

- VG descriptions in table are only available with a Black jacket.
- Component/s for the above cables shall be as listed under "Component" column. e.g. Components for VG95218T028C064 shall be VG95218T023G004, VG95218T023G005 & VG95218T023G006.
- Fillers are used as required.
- Values are for guidance only, refer to drawings for maintained product information.

TABLE COLOR KEY:



VG 95218 Part 28 Type C



VG 95218 T028 C (LFMSGSGO) – Multi Core, Shielded & Wrapped Twisted Pairs/Quads, Overall Shielded & Jacketed Cable

Component Identification

2-pair cable - 0.40mm²

- 1st pair: Black, Blue
- 2nd pair: Black, Brown

4 to 27-pair cable - 0.40mm²

- Black, Blue, Grey, Brown (Black and Grey opposite each other)

4-pair cable

- 1st pair: Black, Blue (Pilot and Direction)
- 2nd pair: Black, Brown (Counting Direction)
- 3rd and following pairs: Black, Grey

Position of pair colors and direction applicable to every cable layer

3-Pair - 1.20mm² & 18-Pair - 0.25mm² cable

- 1st pair 1.20mm²: Black, White. Element coding (Wrap color): Red (Pilot and Direction)
- 2nd pair: 1.20mm²: Black, White. Element coding (Wrap color): Green (Counting Direction)
- 3rd pair: 1.20mm²: Black, White. Element coding (Wrap color): Clear
- 1st pair 0.25mm²: Black, White. Element coding (Wrap color): Red (Pilot and Direction)
- 2nd pair: 0.25mm²: Black, White. Element coding (Wrap color): Green (Counting Direction)
- 3rd and following pairs: 0.25mm²: Black, White. Element coding (Wrap color): Clear

Position of pair colors and direction applicable to every cable layer

27-Star quad cable - 0.25mm²

- 1st Star Quad: Black, White, Grey, Blue. Element coding (Wrap color): Red (Pilot and Direction)
 - 2nd Star Quad: Black, White, Grey, Blue. Element coding (Wrap color): Green (Counting Direction)
 - 3rd and following Star Quad/s: Black, White, Grey, Blue. Element coding (Wrap color): Clear
- Position of Star Quad colors and direction applicable to every cable layer

Cable Jacket Identification

- The mark shall be: Raychem - **VG 95218 T028 C### - K1010 - VDE Reg.Nr. 7095 - LFMSGSGO - (XXX)** where: "###" = VG Dash No. where: "XXX" = No. of Wires x Cross Sectional Area (mm²) e.g: VG95218T028C064 shall be marked: **Raychem - VG95218T028C064 - K1010 - VDE Reg.Nr. 7095 - LFMSGSGO - (12x2x0.4)**

- Color of mark shall be white.

VG Part Description

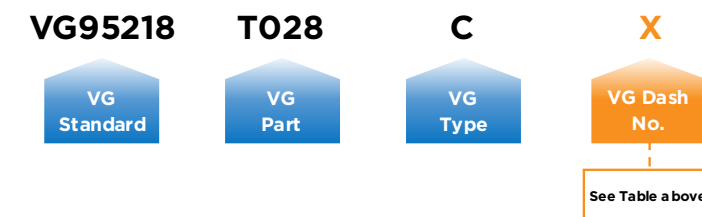

Examples:

- VG95218T028C039 : 2 x 2 x 0.40mm² conductors, 1st pair; Black, Blue & 2nd pair; Black, Brown & Overall Black Jacket
- VG95218T028C075 : 27 x 2 x 0.40mm² conductors, 1st pair; Black, Blue, 2nd pair; Black, Brown, remaining pairs; Black, Grey & Overall Black Jacket
- VG95218T028C078 : 27 x 4 x 0.25mm² conductors, 1st star quad; Black, White, Grey, Blue with Red wrap, 2nd star quad; Black, White, Grey, Blue with Green wrap, remaining star quads; Black, White, Grey, Blue with Clear wrap & Overall Black Jacket

VG 95218 Part 28 Type C



VG 95218 T028 C – Multi Core, Primary Wires, Overall Shielded & Jacketed Cable

- Construction:** Multiple VG95218T020E elements, with overall wrap, shield and jacket
- Conductor:** Stranded tin-coated copper - 0.15mm², 0.40mm², 0.50mm², 0.60mm², 0.75mm², 1.00mm², 1.20mm², 1.50mm², 2.00mm², 2.50mm², 3.00mm²
- Insulation:** Halogen Free Polymer (Primary & Primary jacket)
- Wrap:** Polyester (Overall)
- Shield Material/Type:** Tin-coated copper / Optimized Woven Shield
- Overall Jacket:** Zerohal jacketing material
- Temperature Rating:** -40°C to +105°C
- Voltage Rating:** 600V AC / 900V DC

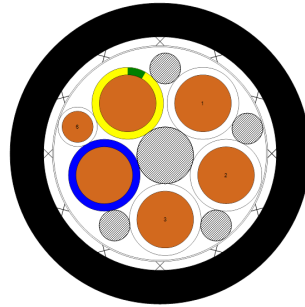

Illustrative Image - VG95218T028C012 example



Product Information Table

Part Description	No. of Wires	No. of Wires x Cross Sectional Area (mm ²)	VG Dash No.	Component	Screen Strand Size		Minimum Wall Thickness (mm)	Cable Diameter (mm)		Max. Weight (kg/km)	Max Resistance @ 20°C (Ohms/km)	Max. Transfer Impedance (mOhms/m)		Nato Stock Number 6145-12-
					AWG	Nom. (mm)		Min.	Max.			@ 10MHz	@ 30MHz	
VG95218T028C080	25	25 x 0.15	080	VG95218T020E129	36	0.127	1.00	9.1	10.1	164	14.10	30	70	---
VG95218T028C007	3	3 x 0.40	007	VG95218T020E029	36	0.127	0.75	5.2	5.8	56	52.00	30	100	---
VG95218T028C124	2	2 x 0.50	124	VG95218T020E039	36	0.127	0.90	4.5	4.9	43	40.10	30	100	---
VG95218T028C125	10	10 x 0.50	125	VG95218T020E039	36	0.127	0.90	7.4	8.2	123	40.10	30	100	---
VG95218T028C004	19	19 x 1.00	004	VG95218T020E069	34	0.160	1.30	12.4	13.2	361	21.40	30	45	---
VG95218T028C006	61	61 x 1.00	006	VG95218T020E069	32	0.203	1.43	19.7	20.9	977	21.40	30	30	---
VG95218T028C013	7	7 x 1.20	013	VG95218T020E079	36	0.127	0.92	8.4	9.2	178	15.80	30	100	---
VG95218T028C017	16	16 x 1.20	017	VG95218T020E079	34	0.160	1.00	11.8	13.0	365	16.20	30	45	---
VG95218T028C001	3	3 x 1.50	001	VG95218T020E089	36	0.127	0.75	6.8	7.4	112	14.10	30	100	348-0984
VG95218T028C002	7	7 x 1.50	002	VG95218T020E089	36	0.127	0.79	8.6	9.2	190	14.00	30	70	---
VG95218T028C008	3	3G x 2.00	008	VG95218T020E096	36	0.127	0.90	7.8	8.6	141	10.80	30	100	---
				VG95218T020E099										
				VG95218T020E09G										
VG95218T028C009	4	4 x 3.00	009	VG95218T020E119	36	0.127	1.00	9.4	10.4	232	6.80	30	70	---
VG95218T028C123	4	3 x 2.00	123	VG95218T020E099	36	0.127	0.99	8.0	8.8	150	10.50	30	100	---
				VG95218T020E096										
		VG95218T020E09G												
		VG95218T020E029												
VG95218T028C126	4	3 x 1.50	126	2 VG95218T020E089	36	0.127	0.90	7.7	8.5	131	13.70	30	30	---
		1 VG95218T020E08G												
		1 x VG95218T020E059												
VG95218T028C127	6	5 x 2.50	127	4 VG95218T020E109	36	0.127	1.00	10.4	11.4	266	8.30	30	30	---
		1 VG95218T020E10G												
		1 x VG95218T020E089												
VG95218T028C012	6	1 x 0.60	012	1 VG95218T020E049	34	0.160	1.00	11.0	12.2	310	32.00	30	45	---
		1 VG95218T020E116												
		3 VG95218T020E119												
		1 VG95218T020E11G												

NOTES:

- VG descriptions in table are only available with a Black jacket.
- Component/s for the above cables shall be as listed under "Component" column. e.g. Components for VG95218T028C080 shall be VG95218T020E129.
- Fillers are used as required.
- Values are for guidance only, refer to drawings for maintained product information.

TABLE COLOR KEY:

- System 25
- System 100
- System 200

VG 95218 Part 28 Type C



VG 95218 T028 C – Multi Core, Primary Wires, Overall Shielded & Jacketed Cable

Component Identification

VG Dash No.- 001, 002, 004, 006, 007, 009, 013, 017, 080, 124, 125

- White, Numbered

VG Dash No.- 008

- White, Blue & Green/Yellow

VG Dash No.- 012

- White, Numbered (1,2,3,6), Blue & Green/Yellow

VG Dash No.- 123

- 2x White, Blue & Green/Yellow

VG Dash No.- 126, 127

- White, Numbered & Green/Yellow

Cable Jacket Identification

- The mark shall be: **Raychem - VG 95218 T028 C### - K1010 - VDE Reg.Nr. 7095** where: "###" = VG Dash No. e.g: VG95218T028C001 shall be marked: **Raychem - VG95218T028C001 - K1010 - VDE Reg.Nr. 7095**
- Color of mark shall be white.

VG Part Description

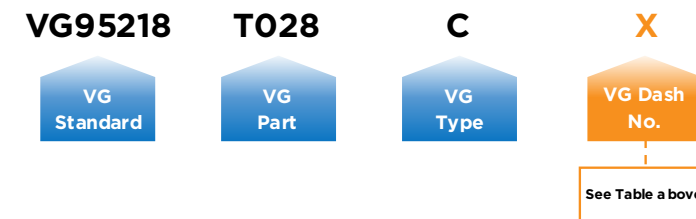

Examples:

- VG95218T028C080 : 25 x 0.15mm² conductors, White, numbered & Overall Black Jacket
- VG95218T028C127 : 5 x 2.50mm², 1 x 1.50mm² conductors, White, Numbered & Green/Yellow & Overall Black Jacket

VG 95218 Part 28 Type C



VG 95218 T028 C – Multi Core, Twisted Pairs, Overall Shielded & Jacketed Cable

- **Construction:** Multiple VG95218T021C pair elements, with overall wrap, shield and jacket
- **Conductor:** Stranded tin-coated copper - 0.25mm², 0.40mm²
- **Insulation:** Halogen Free Polymer (Primary & Primary jacket)
- **Wrap:** Polyester (Overall)
- **Shield Material/Type:** Tin-coated copper / Optimized Woven Shield
- **Overall Jacket:** Zerohal jacketing material
- **Temperature Rating:** -40°C to +105°C
- **Voltage Rating:** 600V AC / 900V DC

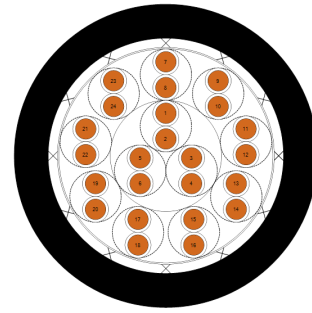

Illustrative Image - VG95218T028C020 example



Product Information Table

Part Description	No. of wires	No. of Wires x Cross Sectional Area (mm ²)	VG Dash No.	Component	Screen Strand Size		Minimum Wall Thickness (mm)	FINISHED CABLE					
					AWG	Nom. (mm)		Cable Diameter (mm)		Max. Weight (kg/km)	Max Resistance @ 20°C (Ohms/km)	Max. Transfer Impedance (mOhms/m)	
								Min.	Max.			@ 10MHz	@ 30MHz
VG95218T028C020	24	12 x 2 x 0.25	020	VG95218T021C001	34	0.160	1.00	10.7	11.7	212	90.00	30	45
VG95218T028C022	38	19 x 2 x 0.25	022	VG95218T021C001	34	0.160	0.80	12.3	13.3	275	90.00	30	45
VG95218T028C023	54	11 x 2 x 0.25	023	VG95218T021C001	32	0.203	1.00	15.8	17.4	490	90.00	30	30
		VG95218T021C001											
VG95218T028C024	66	33 x 2 x 0.25	024	VG95218T021C001	32	0.203	1.00	16.2	17.8	490	90.00	30	30
VG95218T028C025	104	52 x 2 x 0.25	025	VG95218T021C001	32	0.203	1.00	19.5	21.5	707	90.00	30	30
VG95218T028C011	6	3 x 2 x 0.40	011	VG95218T021C002	36	0.127	0.92	7.9	8.7	111	55.00	30	100
VG95218T028C014	10	5 x 2 x 0.40	014	VG95218T021C002	36	0.127	1.21	9.7	10.7	162	55.00	30	100
VG95218T028C018	20	10 x 2 x 0.40	018	VG95218T021C002	34	0.160	1.45	12.1	13.5	269	55.00	30	45

NOTES:

- VG descriptions in table are only available with a Black jacket.
- Component/s for the above cables shall be as listed under "Component" column. e.g. Components for VG95218T028C020 shall be VG95218T021C001.
- Fillers are used as required.
- Values are for guidance only, refer to drawings for maintained product information.

TABLE COLOR KEY:

System 25
System 100
System 200

VG 95218 Part 28 Type C



VG 95218 T028 C – Multi Core, Twisted Pairs, Overall Shielded & Jacketed Cable

Component Identification

Pair element component:

- White, numbered.

Cable Jacket Identification

- The mark shall be: **Raychem - VG 95218 T028 C### - K1010 - VDE Reg.Nr. 7095**
 where: "###" = VG Dash No.
 e.g: VG95218T028C020 shall be marked: **Raychem - VG95218T028C020 - K1010 - VDE Reg.Nr. 7095**
- Color of mark shall be white.

VG Part Description

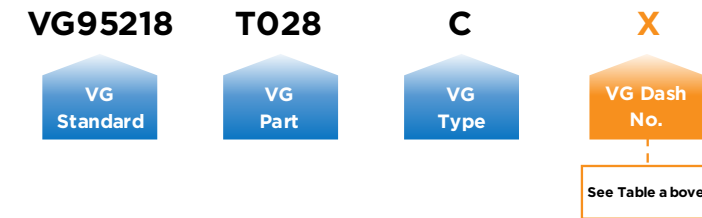

Examples:

VG95218T028C018: 10 x 2 x 0.40mm² conductors, White, numbered components & Overall Black Jacket

VG 95218 Part 28 Type C



VG 95218 T028 C – Multi Core, Various components, Overall Shielded & Jacketed Cable

- Construction:** Various VG95218T020E (Primaries), VG95218T021C (Pairs), VG95218T023C (Screened Jacketed Pairs), VG95218T023G (Screened, Wrapped 20 core) elements, with overall wrap, shield and jacket
- Conductor:** Stranded tin-coated copper - 0.25mm², 0.40mm², 0.60mm², 1.20mm², 1.50mm²
- Insulation:** Halogen Free Polymer (Primary & Primary jacket)
- Wrap:** Polyester (Overall)
- Shield Material/Type:** Tin-coated copper/Optimized Woven Shield (Overall)
- Element/Overall Jacket:** Zerohal jacketing material
- Temperature Rating:** -40°C to +105°C
- Voltage Rating:** 600V AC / 900V DC

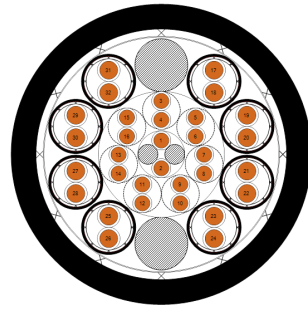

Illustrative Image - VG95218T028C021 example

System
100

Halogen
Free

600V
AC

-40°C
+105°C

Product Information Table

Part Description	No. of wires	No. of Wires x Cross Sectional Area (mm ²)	VG Dash No.	Component	Screen Strand Size		Minimum Wall Thickness (mm)	Cable Diameter (mm)		Max. Weight (kg/km)	Max Resistance @ 20°C (Ohms/km)	Max. Transfer Impedance (mOhms/m)	
					AWG	Nom. (mm)		Min.	Max.			@ 10MHz	@ 30MHz
VG95218T028C015	10	2 x 2 x 0.25	015	VG95218T023C001	34	0.160	1.17	12.0	13.2	276	87.00	30	45
		1 x 2 x 0.60		VG95218T021C004									
		2 x 2 x 1.20		VG95218T021C007									
VG95218T028C016	20	6 x 2 x 0.25	016	VG95218T023C001	34	0.160	1.35	14.7	15.7	363	90.00	30	45
		2 x 2 x 0.25		VG95218T021C001									
		2 x 2 x 0.60		VG95218T021C004									
VG95218T028C019	22	7 x 1.20	019	VG95218T023C037	34	0.160	1.09	14.2	15.8	546	15.80	30	45
		15 x 1.20		VG95218T020E079									
VG95218T028C021	32	2 x 0.25	021	VG95218T020E019	32	0.203	1.09	16.1	17.7	481	87.00	30	30
		7 x 2 x 0.25		VG95218T021C001									
		8 x 2 x 0.25		VG95218T023C001									
VG95218T028C029	36	20 x 0.25	029	VG95218T023G019	32	0.203	1.43	16.6	18.4	542	90.00	30	50
		8 x 2 x 0.25		VG95218T023C001									
VG95218T028C031	49	1 x 3 x 0.40	031	VG95218T021C013	32	0.203	1.09	16.1	17.9	501	51.50	30	30
		6 x 2 x 0.25		VG95218T023C001									
		17 x 2 x 0.25		VG95218T021C001									
VG95218T028C079	12	4 x 2 x 0.40	079	4 VG95218T021C002	34	0.160	1.09	10.8	11.8	288	53.00	30	45
		4 x 1.50		4 VG95218T020E089									
VG95218T028C081	27	9 x 2 x 0.40	081	9 VG95218T021C002	34	0.160	1.09	14.1	15.3	421	56.00	30	45
		9 x 1.50		9 VG95218T020E089									

NOTES:

- VG descriptions in table are only available with a Black jacket.
- Component/s for the above cables shall be as listed under "Component" column. e.g. Components for VG95218T028C015 shall be VG95218T023C001, VG95218T021C004 & VG95218T021C007.
- Fillers are used as required.
- Values are for guidance only, refer to drawings for maintained product information.

TABLE COLOR KEY:

	System 25
	System 100
	System 200

VG 95218 Part 28 Type C



VG 95218 T028 C – Multi Core, Various components, Overall Shielded & Jacketed Cable

Component Identification

VG Dash No.- 015, 016:

- Pairs: White, numbered.
- Screened, Jacketed Pairs: White, numbered, Black jacket.

VG Dash No.- 019:

- Central Screened, Jacketed 7 core: White, numbered, Black jacket.
- Primaries: White, numbered.

VG Dash No.- 021, 031:

- Primaries: White, numbered.
- Pairs: White, numbered.
- Screened, Jacketed Pairs: White, numbered, Black jacket.

VG Dash No.- 029:

- Central Screened, Wrapped 20 core: White, numbered.
- Screened, Jacketed Pairs: White, numbered, Black jacket.

VG Dash No.- 079, 081:

- Primaries: White, numbered.
- Pairs: White, numbered.

Cable Jacket Identification

- The mark shall be: **Raychem - VG 95218 T028 C### - K1010 - VDE Reg.Nr. 7095** where: "###" = VG Dash No. e.g: VG95218T028C015 shall be marked: **Raychem - VG95218T028C015 - K1010 - VDE Reg.Nr. 7095**
- Color of mark shall be white.

VG Part Description

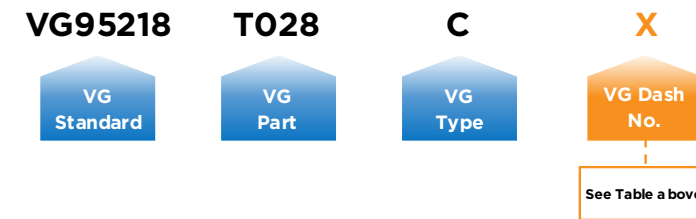

Examples:

- VG95218T028C015 : 2 x 2 x 0.25mm², 1 x 2 x 0.60mm² & 2 x 2 x 1.20mm² conductors, 3x Pairs: White, numbered components, 2x Screened Jacketed Pairs: White, numbered components, Black Jacket & Overall Black Jacket
- VG95218T028C079 : 4 x 2 x 0.40mm² & 4 x 1.50mm² conductors, 4x Pairs: White, numbered components, 4x Primaries: White, numbered components & Overall Black Jacket

VG 95218 Part 28 Type D



VG 95218 T028 D – Multi Core, Twisted Pairs, Overall Shielded & Jacketed Cable

- **Construction:** Multiple VG95218T021E & VG95218T021B pair elements, with overall wrap, shield and jacket
- **Conductor:** Stranded tin-coated copper - 0.15mm², 0.25mm², 0.40mm², 0.60mm², 1.20mm²
- **Insulation:** Polyalkene (Primary), PVDF (Primary jacket)
- **Shield Material/Type:** Tin-coated copper / Optimized Woven Shield
- **Overall Jacket:** Fuel & Diesel Resistant Elastomer - FDR25
- **Temperature Rating:** -40°C to +150°C
- **Voltage Rating:** See table below

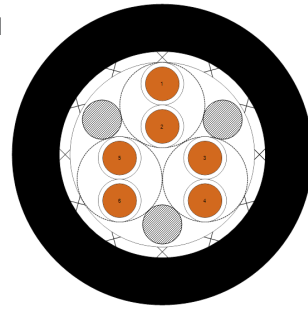

Illustrative Image - VG95218T028D018 example



Product Information Table

Part Description	No. of wires	No. of Wires x Cross Sectional Area (mm ²)	VG Dash No.	Component	Screen Strand Size		Minimum Wall Thickness (mm)	Cable Diameter (mm)		Max. Weight (kg/km)	Max Resistance @ 20°C (Ohms/km)	Max. Transfer Impedance @ 30MHz (mOhms/m)	Nato Stock Number 6145-12-	Voltage Rating (AC/DC)
					AWG	Nom. (mm)		Min.	Max.					
VG95218T028D028	24	12 x 2 x 0.25	028	VG95218T021E010	34	0.160	0.96	9.8	10.8	182	93.80	45	325-0722	600/900
VG95218T028D046	38	19 x 2 x 0.25	046	VG95218T021E010	34	0.160	0.79	11.4	12.2	240	93.80	45	---	600/900
VG95218T028D048	66	33 x 2 x 0.25	048	VG95218T021E010	32	0.203	0.84	14.5	15.3	393	93.80	30	---	600/900
VG95218T028D047	54	11 x 2 x 0.25	047	VG95218T021E010	32	0.203	1.18	15.0	16.0	415	93.80	30	---	600/900
		16 x 2 x 0.25	047	VG95218T021E010										
VG95218T028D049	104	52 x 2 x 0.25	049	VG95218T021E010	32	0.203	0.92	17.6	18.6	572	93.80	30	---	600/900
VG95218T028D018	6	3 x 2 x 0.40	018	VG95218T021E001	36	0.127	0.92	7.3	8.1	94	55.30	100	309-6466	600/900
VG95218T028D015	8	4 x 2 x 0.40	015	VG95218T021E001	36	0.127	0.92	7.8	8.6	110	55.30	100	312-6714	600/900
VG95218T028D051	10	5 x 2 x 0.40	051	VG95218T021E001	36	0.127	1.22	9.2	10.0	141	55.30	100	---	600/900
VG95218T028D052	20	10 x 2 x 0.40	052	VG95218T021E001	34	0.160	1.47	11.5	12.3	221	58.00	45	---	600/900
VG95218T028D012	4	2 x 2 x 0.60	012	VG95218T021E002	36	0.127	0.88	7.9	8.7	106	34.90	100	308-3331	600/900
VG95218T028D020	6	3 x 2 x 1.20	020	VG95218T021E003	34	0.160	0.58	9.0	10.0	180	17.00	45	312-6173	600/900
VG95218T028D086	10	5 x 2 x 0.15	086	VG95218T021B009	36	0.127	1.18	7.5	8.1	88	141.00	100	345-2496	600/600
				VG95218T021B010										
				VG95218T021B011										
				VG95218T021B012										
				VG95218T021B013										

- NOTES:**
- VG descriptions in table are only available with a Black jacket.
 - Component/s for the above cables shall be as listed under "Component" column. e.g. Components for VG95218T028D028 shall be VG95218T021E010.
 - Fillers are used as required.
 - Values are for guidance only, refer to drawings for maintained product information.

TABLE COLOR KEY:

System 25
System 100
System 200

VG 95218 Part 28 Type D



VG 95218 T028 D – Multi Core, Twisted Pairs, Overall Shielded & Jacketed Cable

Component Identification

VG Dash No.- 012, 015, 018, 020, 028, 046, 047, 048, 049, 051, 052:

- White, numbered.

VG Dash No.- 086:

- Black/White, Brown/White, Red/White, Yellow/White, Orange/White

Cable Jacket Identification

- The mark shall be: **Raychem - VG 95218 T028 D### - K1010 - VDE Reg.Nr. 9425**

where: "###" = VG Dash No.

e.g: VG95218T028D018 shall be marked: **Raychem - VG95218T028D018 - K1010 - VDE Reg.Nr. 9425**

- Color of mark shall be white.

VG Part Description

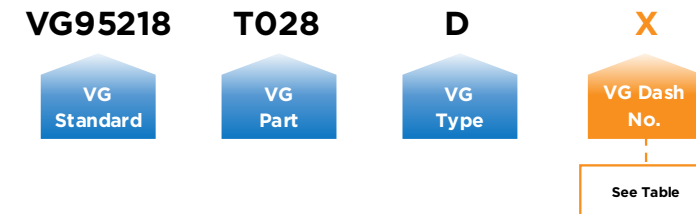

Examples:

VG95218T028D018 : 3 x 2 x 0.40mm² conductors, 3 x Pairs, White, numbered & Overall Black Jacket

VG95218T028D086 : 5 x 2 x 0.15mm² conductors, 5 x Pairs, Black/White, Brown/White, Red/White, Yellow/White, Orange/White & Overall Black Jacket

VG 95218 Part 28 Type D



VG 95218 T028 D – Multi Core, Screened Jacketed Twisted Pairs, Overall Shielded & Jacketed Cable

- **Construction:** Multiple VG95218T023F pair elements, with overall wrap, shield and jacket
- **Conductor:** Stranded tin-coated copper - 0.40mm², 1.20mm²
- **Insulation:** Polyalkene (Primary), PVDF (Primary jacket)
- **Shield Material/Type:** Tin-coated copper / Optimized Woven Shield (Individual & Overall)
- **Overall Jacket:** Fuel & Diesel Resistant Elastomer - FDR25
- **Temperature Rating:** -40°C to +150°C
- **Voltage Rating:** 600V AC / 900V DC

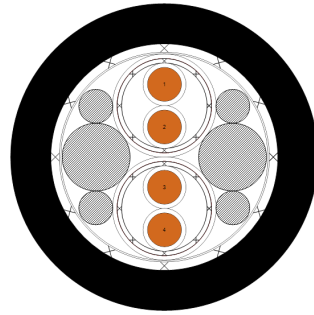

Illustrative Image - VG95218T028D056 example



Product Information Table

Part Description	No. of wires	No. of Wires x Cross Sectional Area (mm ²)	VG Dash No.	Component	Screen Strand Size		Minimum Wall Thickness (mm)	FINISHED CABLE						
					AWG	Nom. (mm)		Cable Diameter (mm)		Max. Weight (kg/km)	Max Resistance @ 20°C (Ohms/km)	Max. Transfer Impedance @ 30MHz (mOhms/m)	Nato Stock Number 6145-12-	Voltage Rating (AC/DC)
								Min.	Max.					
VG95218T028D056	4	2 x 2 x 0.40	056	VG95218T023F001	36	0.127	1.01	9.5	10.5	149	55.30	70	325-0722	600/900
VG95218T028D066	16	8 x 2 x 1.20	066	VG95218T023F013	32	0.203	0.90	18.2	20.2	666	17.00	30	---	600/900

NOTES:

- VG descriptions in table are only available with a Black jacket.
- Component/s for the above cables shall be as listed under "Component" column. e.g. Components for VG95218T028D056 shall be VG95218T023F001.
- Fillers are used as required.
- Values are for guidance only, refer to drawings for maintained product information.

TABLE COLOR KEY:

- System 25
- System 100
- System 200

VG 95218 Part 28 Type D



VG 95218 T028 D – Multi Core, Screened Jacketed Twisted Pairs, Overall Shielded & Jacketed Cable

Component Identification

VG Dash No.- 056:

- Screened, Jacketed Pairs: White, numbered, White jacket

VG Dash No.- 066:

- Screened, Jacketed Pairs: White, numbered, White jacket, numbered

Cable Jacket Identification

- The mark shall be: **Raychem - VG 95218 T028 D### - K1010 - VDE Reg.Nr. 9425**
where: "###" = VG Dash No.
e.g: VG95218T028D056 shall be marked: **Raychem - VG95218T028D056 - K1010 - VDE Reg.Nr. 9425**
- Color of mark shall be white.

VG Part Description

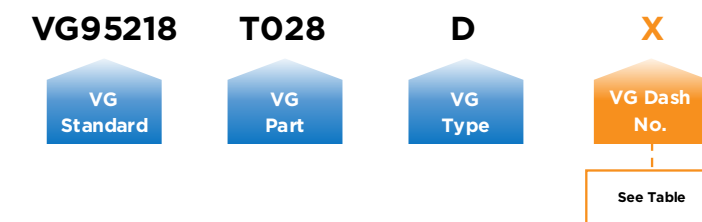

Examples:

VG95218T028D056 : 2 x 2 x 0.40mm² conductors, 2x Screened Jacketed Pairs: White, numbered components, White Jacket & Overall Black Jacket

VG 95218 Part 28 Type D



VG 95218 T028 D – Multi Core, Various components, Overall Shielded & Jacketed Cable

- Construction:** Various VG95218T020A (Primary), M81044 (Primary), VG95218T021E (Pairs, Triples), VG95218T022C (Screened Primary), VG95218T022B (Screened Primary), VG95218T023F (Screened Jacketed Pair, Triple, Quad, Pentad, Heptad), VG95218T023B (Screened Jacketed Pair, Octad) elements with overall wrap, shield and jacket
- Conductor:** Stranded tin-coated copper - 0.15mm², 0.25mm², 0.40mm², 0.50mm², 0.60mm², 1.00mm², 1.20mm², 3.00mm²
- Insulation:** Polyalkene (Primary), PVDF (Primary jacket)
- Individual Jacket:** PVDF, FDR25
- Wrap:** Polyester (Overall)
- Shield Material/Type:** Tin-coated copper / Optimized Woven Shield (Individual & Overall)
- Element/Overall Jacket:** Fuel & Diesel Resistant Elastomer - FDR25
- Temperature Rating:** -40°C to +150°C
- Voltage Rating:** See table below

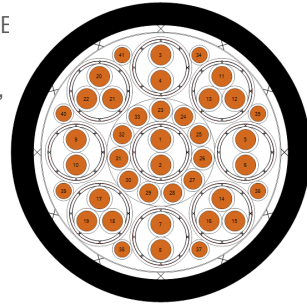

Illustrative Image - VG95218T028D055 example



Product Information Table

Part Description	No. of wires	No. of Wires x Cross Sectional Area (mm ²)	VG Dash No.	Component	Screen Strand Size		Minimum Wall Thickness (mm)	Cable Diameter (mm)		Max. Weight (kg/km)	Max Resistance @ 20°C (Ohms/km)	Max. Transfer Impedance @ 30MHz (mOhms/m)	Nato Stock Number 6145-12-	Voltage Rating (AC/DC)
					AWG	Nom. (mm)		Min.	Max.					
					FINISHED CABLE									
VG95218T028D016	5	2 x 2 x 0.40 1 x 0.40	016	VG95218T021E001 VG95218T022C001	36	0.127	0.92	7.3	8.1	96	55.30 54.20	100	309-6467	600/900
VG95218T028D062	7	1 x 1.00 3 x 2 x 1.20	062	VG95218T020A005 VG95218T023F013	34	0.160	1.10	12.6	13.8	304	21.40 17.00	45	---	600/900
VG95218T028D050	8	1 x 0.15 1 x 0.15 1 x 0.15 1 x 0.15 1 x 0.15 1 x 0.15 1 x 0.15	050	VG95218T022B005 VG95218T022B006 VG95218T022B007 VG95218T022B008 M81044/12-26-0 M81044/12-26-2 M81044/12-26-6 M81044/12-26-9	36	0.127	0.62	6.3	6.9	80	138.00	100	309-2911	600/600
VG95218T028D039	9	3 x 3.00 1 x 2 x 3.00 1 x 4 x 3.00	039	VG95218T020A017 VG95218T023F018 VG95218T023F019	32	0.203	1.90	18.5	19.3	685	6.77 7.10	30	325-0723	600/900
VG95218T028D045	9	1 x 2 x 0.25 2 x 2 x 0.25 1 x 2 x 0.40 1 x 0.25	045	VG95218T023F010 VG95218T021E010 VG95218T021E001 VG95218T020A016	36	0.127	0.62	7.4	8.2	101	89.50 55.30 86.00	100	306-9003	600/900
VG95218T028D033	10	4 x 1.20 2 x 3 x 1.20	033	VG95218T020A006 VG95218T023F015	34	0.160	1.09	12.9	14.3	355	16.70 17.00	45	320-9719	600/900
VG95218T028D040	10	7 x 0.40 1 x 0.40 1 x 2 x 0.40	040	VG95218T020A001 VG95218T022C001 VG95218T023F001	36	0.127	1.30	9.4	10.0	157	54.20	100	---	600/900
VG95218T028D063	10	2 x 5 x 1.20	063	VG95218T023F020	32	0.203	1.09	15.0	16.2	427	17.00	30	---	

- NOTES:**
- VG descriptions in table are only available with a Black jacket.
 - Component/s for the above cables shall be as listed under "Component" column. e.g. Components for VG95218T028D016 shall be VG95218T021E001 & VG95218T022C001.
 - Fillers are used as required.
 - Values are for guidance only, refer to drawings for maintained product information.

TABLE COLOR KEY:

System 25
System 100
System 200

VG 95218 Part 28 Type D



VG 95218 T028 D – Multi Core, Various components, Overall Shielded & Jacketed Cable

Product Information Table (Continued)

Part Description	No. of wires	No. of Wires x Cross Sectional Area (mm ²)	VG Dash No.	Component	Screen Strand Size		Minimum Wall Thickness (mm)	Cable Diameter (mm)		Max. Weight (kg/km)	Max Resistance @ 20°C (Ohms/km)	Max. Transfer Impedance @ 30MHz (mOhms/m)	Nato Stock Number 6145-12-	Voltage Rating (AC/DC)
					AWG	Nom. (mm)		Min.	Max.					
					FINISHED CABLE									
VG95218T028D064	10	4 x 1.20 1 x 2 x 1.20 1 x 4 x 1.20	064	VG95218T020A006 VG95218T023F013 VG95218T023F016	34	0.160	1.26	13.1	14.5	361	16.70 17.00	45	---	600/900
VG95218T028D071	10	2 x 2 x 1.20 1 x 2 x 0.60 2 x 2 x 0.25	071	VG95218T021E003 VG95218T021E002 VG95218T023F010	34	0.160	1.30	12.0	13.4	258	16.70 34.90 89.50	45	---	600/900
VG95218T028D022	12	3 x 0.60 9 x 0.60	022	VG95218T022C003 VG95218T020A003	34	0.160	0.96	10.4	11.4	226	35.80	45	310-3627	600/900
VG95218T028D041	12	9 x 0.40 3 x 0.40	041	VG95218T020A001 VG95218T022C001	36	0.127	1.26	10.3	10.9	178	56.80	70	331-8325	600/900
VG95218T028D079	12	2 x 2 x 1.20 3 x 2 x 0.60 2 x 0.60	079	VG95218T021E003 VG95218T021E002 VG95218T020A003	34	0.160	1.01	11.3	12.5	246	17.00 34.90 34.20	45	---	600/900
VG95218T028D080	12	4 x 2 x 0.60 4 x 1.20	080	VG95218T023F002 VG95218T020A006	34	0.160	1.01	11.8	13.0	295	34.90 16.70	45	---	600/900
VG95218T028D083	12	1 x 2 x 0.25 1 x 3 x 0.25 4 x 0.60 1 x 3 x 0.60	083	VG95218T023F010 VG95218T023F006 VG95218T022C003 VG95218T021E005	34	0.160	1.01	10.8	12.0	236	89.50 34.20 34.90	45	---	600/900
VG95218T028D029	14	1 x 2 x 0.40 4 x 0.40 4 x 2 x 0.40	029	VG95218T023F001 VG95218T022C001 VG95218T021E001	34	0.160	0.96	10.1	11.1	208	56.80	45	321-3640	600/900
VG95218T028D065	15	2 x 1.20 1 x 2 x 1.20 2 x 3 x 1.20 1 x 5 x 1.20	065	VG95218T020A006 VG95218T023F013 VG95218T023F015 VG95218T023F020	32	0.203	1.09	15.5	17.1	514	16.70 17.00	30	---	600/900
VG95218T028D054	19	13 x 0.40 6 x 0.40	054	VG95218T020A001 VG95218T022C001	36	0.160	1.01	11.1	12.3	256	56.80	45	---	600/900
VG95218T028D059	19	15 x 1.20 4 x 1.20	059	VG95218T020A006 VG95218T022C006	34	0.160	1.09	14.0	15.4	469	17.50	45	---	600/900
VG95218T028D081	19	5 x 0.60 2 x 3 x 0.60 4 x 2 x 0.60	081	VG95218T020A003 VG95218T021E005 VG95218T023F002	34	0.160	1.09	12.9	14.3	340	34.20 34.90	45	350-9679	600/900
VG95218T028D068	20	3 x 2 x 1.20 3 x 3 x 1.20 1 x 5 x 1.20	068	VG95218T023F013 VG95218T021E011 VG95218T023F020	32	0.203	1.18	18.2	20.2	657	17.00	30	---	600/900
VG95218T028D072	20	2 x 2 x 0.60 2 x 2 x 0.25 6 x 2 x 0.25	072	VG95218T021E002 VG95218T021E010 VG95218T023F010	34	0.160	1.30	14.7	15.7	344	34.90 89.50	45	---	600/900
VG95218T028D069	21	2 x 3 x 1.20 2 x 4 x 1.20 1 x 7 x 1.20	069	VG95218T023F015 VG95218T023F016 VG95218T023F021	32	0.203	1.18	17.8	19.6	697	17.00	30	---	600/900
VG95218T028D007	22	1 x 7 x 1.20 15 x 1.20	007	VG95218T023F017 VG95218T020A006	34	0.160	1.09	13.7	15.1	499	16.70 17.50	45	309-3198	600/900

- NOTES:**
- VG descriptions in table are only available with a Black jacket.
 - Component/s for the above cables shall be as listed under "Component" column. e.g. Components for VG95218T028D016 shall be VG95218T021E001 & VG95218T022C001.
 - Fillers are used as required.
 - Values are for guidance only, refer to drawings for maintained product information.

TABLE COLOR KEY:

System 25
System 100
System 200



VG 95218 Part 28 Type D

VG 95218 T028 D – Multi Core, Various components, Overall Shielded & Jacketed Cable

Product Information Table (Continued)

Part Description	No. of wires	No. of Wires x Cross Sectional Area (mm ²)	VG Dash No.	Component	Screen Strand Size		Minimum Wall Thickness (mm)	Cable Diameter (mm)		Max. Weight (kg/km)	Max Resistance @ 20°C (Ohms/km)	Max. Transfer Impedance @ 30MHz (mOhms/m)	Nato Stock Number 6145-12-	Voltage Rating (AC/DC)
					AWG	Nom. (mm)		Min.	Max.					
VG95218T028D027	23	3 x 0.40	027	VG95218T022B004	34	0.160	1.01	11.0	12.2	262	56.80	45	310-3626	600/600
		16 x 0.40		M81044/12-22-9							34.70			
		4 x 0.50		M81044/12-20-9										
VG95218T028D034	24	12 x 0.25	034	VG95218T020A016	34	0.160	1.01	10.5	11.7	206	92.00	---	600/900	
		6 x 2 x 0.25		VG95218T021E010							93.80			
VG95218T028D076	25	3 x 3 x 0.60	076	VG95218T021E005	34	0.160	1.09	13.6	15.0	403	36.60	45	350-9678	600/900
		3 x 0.60		VG95218T020A003							35.80			
		13 x 0.40		VG95218T022C001							56.80			
VG95218T028D031	26	2 x 1.00	031	VG95218T020A004	34	0.160	1.01	10.5	11.7	215	28.50	45	319-5733	600/900
		12 x 0.25		VG95218T020A016							92.00			
		6 x 2 x 0.25		VG95218T021E010							93.80			
VG95218T028D073	32	2 x 0.25	073	VG95218T020A016	32	0.203	1.09	15.0	16.0	388	89.50	30	---	600/900
		7 x 2 x 0.25		VG95218T021E010										
		8 x 2 x 0.25		VG95218T023F010										
VG95218T028D058	37	34 x 1.20	058	VG95218T020A006	32	0.203	1.09	16.8	18.6	764	17.50	30	---	600/900
		3 x 1.20		VG95218T022C006										
VG95218T028D030	39	16 x 0.40	030	VG95218T022C001	32	0.203	1.09	17.2	18.4	600	56.80	30	301-0501	600/900
		7 x 3 x 0.60		VG95218T021E005							36.60			
		2 x 1.20		VG95218T020A006							17.50			
VG95218T028D035	39	2 x 0.60	035	VG95218T020A003	32	0.203	1.18	19.4	21.6	763	35.80	30	348-0143	600/900
		2 x 1.20		VG95218T020A006							17.50			
		3 x 3 x 0.60		VG95218T021E005							36.60			
		13 x 2 x 0.60		VG95218T023F002										
VG95218T028D082	39	2 x 1.20	082	VG95218T020A006	32	0.203	1.09	16.7	18.5	595	17.50	30	350-9680	600/900
		9 x 3 x 0.60		VG95218T021E005							36.60			
		10 x 0.50		VG95218T022C002							45.30			
VG95218T028D055	41	8 x 0.40	055	VG95218T020A001	32	0.203	1.05	16.9	18.7	635	56.80	30	---	600/900
		11 x 0.60		VG95218T020A003							35.80			
		5 x 2 x 0.60		VG95218T023F002							36.60			
		4 x 3 x 0.60		VG95218T023F005										
VG95218T028D075	42	3 x 2 x 1.20	075	VG95218T023B003	32	0.203	0.92	20.0	21.0	795	16.40	30	325-4022	600/600
		18 x 2 x 0.25		VG95218T023B002							93.80			
VG95218T028D074	48	1 x 8 x 0.50	048	VG95218T023B005	32	0.203	1.09	16.8	18.4	700		30	314-8100	600/900
		1 x 0.50		M81044/12-20-6							33.00			
		1 x 0.50		M81044/12-20-2										
		14 x 0.50		M81044/12-20-9										
		2 x 1.20		M81044/12-16-9							16.10			
		1 x 0.50		M81044/12-20-6										
		1 x 0.50		M81044/12-20-2							33.00			
		20 x 0.50		M81044/12-20-9										

NOTES:

- VG descriptions in table are only available with a Black jacket.
- Component/s for the above cables shall be as listed under "Component" column. e.g. Components for VG95218T028D016 shall be VG95218T021E001 & VG95218T022C001.
- Fillers are used as required.
- Values are for guidance only, refer to drawings for maintained product information.

TABLE COLOR KEY:

	System 25
	System 100
	System 200



VG 95218 Part 28 Type D

VG 95218 T028 D – Multi Core, Various components, Overall Shielded & Jacketed Cable

Component Identification

VG Dash No.- 007:

- Primaries: White - Numbered
- Screened, Jacketed Heptad (7 core): White cores - Numbered, White jacket

VG Dash No.- 016:

- Pairs: White cores - Numbered
- Screened, Jacketed Primary: White cores, White jacket - Numbered

VG Dash No.- 027, 054, 058 & 059:

- Primaries: White - Numbered
- Screened, Jacketed Primaries: White cores, White jacket - Numbered

VG Dash No.- 030, 076 & 082:

- Primaries: White - Numbered
- Screened, Jacketed Primaries: White cores, White jacket - Numbered
- Triples: White cores - Numbered

VG Dash No.- 031 & 034:

- Primaries: White - Numbered
- Pairs: White cores - Numbered

VG Dash No.- 033:

- Primaries: White - Numbered
- Screened, Jacketed Triples: White cores - Numbered, White jacket

VG Dash No.- 035:

- Primaries: White - Numbered
- Screened, Jacketed Pairs: White cores - Numbered, White jacket
- Triples: White cores - Numbered

VG Dash No.- 039:

- Primaries: White - Numbered
- Screened, Jacketed Pairs: White cores - Numbered, White jacket
- Screened, Jacketed Quad: White cores - Numbered, White jacket

VG Dash No.- 040:

- Primaries: White - Numbered
- Screened, Jacketed Primary: White core - Numbered, White jacket
- Screened, Jacketed Pairs: White cores - Numbered, White jacket

VG Dash No.- 045:

- Primary: White - Numbered
- Pairs: White cores - Numbered
- Screened, Jacketed Pairs: White cores - Numbered, White jacket



VG 95218 Part 28 Type D

VG 95218 T028 D – Multi Core, Various components, Overall Shielded & Jacketed Cable

Component Identification

VG Dash No.- 048:

- Primaries: 2x Red, 2x Blue, 36x White
- Screened, Jacketed Octad (8 Core): 1x Red, 1x Blue, 6x White cores, White jacket

VG Dash No.- 050:

- Primaries: 1x Black, 1x Red, 1x Blue, 1x White
- Screened, Jacketed Primaries: 1x White core, White jacket, 1x White core, White jacket - Black Stripe, 1x White core, White jacket - Brown Stripe, 1x White core, White jacket - Red Stripe

VG Dash No.- 055:

- Primaries: White - Numbered
- Screened, Jacketed Pairs: White cores - Numbered, White jacket
- Screened, Jacketed Triples: White cores - Numbered, White jacket

VG Dash No.- 062:

- Primary: White - Numbered
- Screened, Jacketed Pairs: White cores - Numbered, White jacket - Numbered

VG Dash No.- 063:

- Screened, Jacketed Pentad (5 core): White cores - Numbered, White jacket - Numbered

VG Dash No.- 064:

- Primaries: White - Numbered
- Screened, Jacketed Pair: White cores - Numbered, White jacket - Numbered
- Screened, Jacketed Quad: White cores - Numbered, White jacket - Numbered

VG Dash No.- 065:

- Primaries: White - Numbered
- Screened, Jacketed Pair: White cores - Numbered, White jacket - Numbered
- Screened, Jacketed Triples: White cores - Numbered, White jacket - Numbered
- Screened, Jacketed Pentad (5 core): White cores - Numbered, White jacket - Numbered

VG Dash No.- 068:

- Triples: White cores - Numbered
- Screened, Jacketed Pairs: White cores - Numbered, White jacket - Numbered
- Screened, Jacketed Pentad (5 core): White cores - Numbered, White jacket

VG Dash No.- 069:

- Screened, Jacketed Triples: White cores - Numbered, White jacket - Numbered
- Screened, Jacketed Quads: White cores - Numbered, White jacket - Numbered
- Screened, Jacketed Heptad (7 core): White cores - Numbered, White jacket - Numbered



VG 95218 Part 28 Type D

VG 95218 T028 D – Multi Core, Various components, Overall Shielded & Jacketed Cable

Component Identification

VG Dash No.- 072:

- Pairs: White cores - Numbered
- Screened, Jacketed Pairs: White cores - Numbered, White jacket

VG Dash No.- 073:

- Primaries: White - Numbered
- Pairs: White cores - Numbered
- Screened, Jacketed Pairs: White cores - Numbered, White jacket

VG Dash No.- 075:

- Screened, Jacketed Pairs: 3x Pilot - Black/White cores, White jacket - Red Stripe, 3x Direction - Black/White cores, White jacket - Green Stripe, 15x Remainder - Black/White cores, White jacket

VG Dash No.- 081:

- Primaries: White - Numbered
- Triples: White cores - Numbered
- Screened, Jacketed Pairs: White cores - Numbered, White jacket

Cable Jacket Identification

- The mark shall be: **Raychem - VG 95218 T028 D### - K1010 - VDE Reg.Nr. 9425**
 where: "###" = VG Dash No.
 e.g: VG95218T028D016 shall be marked: **Raychem - VG95218T028D016 - K1010 - VDE Reg.Nr. 9425**
- Color of mark shall be white.

VG Part Description

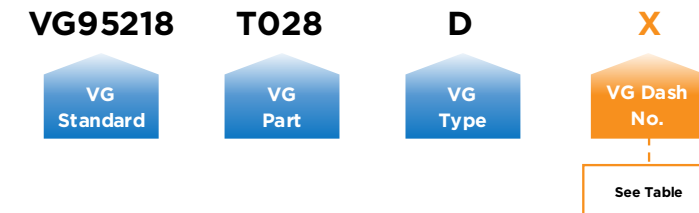

Examples:

- VG95218T028D016 : 2 x 2 x 0.40mm² & 1 x 0.40mm² conductors, 2x Pairs: White components - numbered, 1x Screened, Jacketed Primary: White component, White jacket - numbered, Overall Black Jacket
- VG95218T028D063 : 2 x 5 x 1.20mm² conductors, 2x Screened, Jacketed Pentads (5 core): White, numbered components, White Jacket - numbered & Overall Black Jacket

T020
T021
T022
T023
T024
T025
T027
T028
T061 to 66

T020
T021
T022
T023
T024
T025
T027
T028
T061 to 66

VG 95218 Part 28 Type E



VG 95218 T028 E (LFMGSSGO) – Multi Core, Twisted Pairs, Double Overall Shielded & Jacketed Cable

- **Construction:** Multiple VG95218T021C pair elements, with overall wrap, double shield isolated with double wrap and jacket
- **Conductor:** Stranded tin-coated copper - 0.40mm²
- **Insulation:** Halogen Free Polymer (Primary & Primary jacket)
- **Wrap:** Polyester (Overall)
- **Shield Material/Type:** Tin-coated copper / Optimized Woven Shield
- **Overall Jacket:** Zerohal jacketing material
- **Temperature Rating:** -40°C to +105°C
- **Voltage Rating:** 600V AC / 900V DC

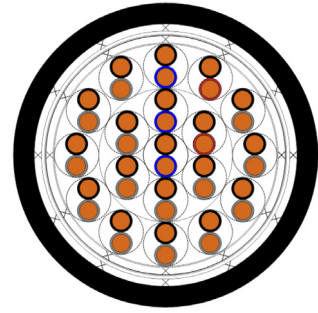

Illustrative Image - VG95218T028E010 example



Product Information Table

Part Description	No. of wires	No. of Wires x Cross Sectional Area (mm ²)	VG Dash No.	Component	Screen Strand Size		Minimum Wall Thickness (mm)	Cable Diameter (mm)		Max. Weight (kg/km)	Max Resistance @ 20°C (Ohms/km)	Max. Transfer Impedance (mOhms/m)	
					AWG	Nom. (mm)		Min.	Max.			@ 10MHz	@ 30MHz
VG95218T028E004	4	2 x 2 x 0.40	004	VG95218T021C047	36	0.127	36	0.127	0.70	5.8	6.4	78	52.0
VG95218T028E005	8	4 x 2 x 0.40	005	1 VG95218T021C039	36	0.127	36	0.127	0.70	8.0	9.0	139	52.0
				2 VG95218T021C040									
VG95218T028E006	14	7 x 2 x 0.40	006	2 VG95218T021C039	36	0.127	34	0.160	0.70	9.5	10.5	184	55.0
				4 VG95218T021C040									
VG95218T028E008	24	12 x 2 x 0.40	008	2 VG95218T021C039	34	0.160	34	0.160	0.80	11.5	12.7	285	55.0
				8 VG95218T021C040									
VG95218T028E010	38	19 x 2 x 0.40	010	3 VG95218T021C039	34	0.160	34	0.160	0.80	13.6	15.0	396	55.0
				2 VG95218T021C038									
				14 VG95218T021C040									
VG95218T028E011	54	27 x 2 x 0.40	011	3 VG95218T021C039	32	0.203	32	0.203	0.90	16.1	17.9	569	55.0
				3 VG95218T021C038									
				21 VG95218T021C040									

NOTES:

- VG descriptions in table are only available with a Black jacket.
- Component/s for the above cables shall be as listed under "Component" column. e.g. Components for VG95218T028E004 shall be VG95218T021C047.
- Fillers are used as required.
- Values are for guidance only, refer to drawings for maintained product information.

TABLE COLOR KEY:

	System 25
	System 100
	System 200

VG 95218 Part 28 Type E



VG 95218 T028 E (LFMGSSGO) – Multi Core, Twisted Pairs, Double Overall Shielded & Jacketed Cable

Component Identification

2-pair cable (2 pairs = 1 Star Quad)

- Black, Blue, Grey, Brown (Black and Grey opposite each other)

4 to 27-pair cable

- 1st pair: Black, Blue (Pilot and Direction)
- 2nd pair: Black, Brown (Counting Direction)
- 3rd and following pairs: Black, Grey

Position of pair colors and direction applicable to every cable layer

Cable Jacket Identification

- The mark shall be: **Raychem - VG 95218 T028 E### - K1010 - VDE Reg.Nr. 7708 - LFMGSSGO - (XXX)** where: "###" = VG Dash No. where: "XXX" = No. of Wires x Cross Sectional Area (mm²) e.g: VG95218T028E004 shall be marked: **Raychem - VG95218T028E004 - K1010 - VDE Reg.Nr. 7708 - LFMGSSGO - (2x2x0.4)**

- Color of mark shall be white.

VG Part Description

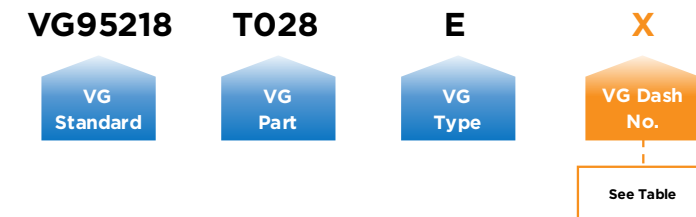

Examples:

- VG95218T028E004 : 2 x 2 x 0.40mm² conductors, Black, Blue, Grey, Brown (Star Quad) & Overall Black Jacket
- VG95218T028E011 : 27 x 2 x 0.40mm² conductors, 1st pair; Black, Blue, 2nd pair; Black, Brown, remaining pairs; Black, Grey & Overall Black Jacket

VG 95218 Part 28 Type E



VG 95218 T028 E (LFMSGSSGO) – Multi Core, Shielded Wrapped Twisted Triples, Double Overall Shielded & Jacketed Cable

- **Construction:** Multiple VG95218T023G Triple elements, individual screens & wraps, with overall wrap, double shield isolated with double wrap and jacket
- **Conductor:** Stranded tin-coated copper - 0.40mm²
- **Insulation:** Halogen Free Polymer (Primary & Primary jacket)
- **Wrap:** Polyester (Individual & Overall)
- **Shield Material/Type:** Tin-coated copper / Optimized Woven Shield
- **Overall Jacket:** Zerohal jacketing material
- **Temperature Rating:** -40°C to +105°C

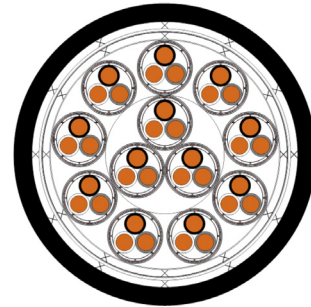

Illustrative Image - VG95218T028E009 example

System
100

Halogen
Free

600V
AC

-40°C
+105°C

Product Information Table

Part Description	No. of wires	No. of Wires x Cross Sectional Area (mm ²)	VG Dash No.	Component	Screen Strand Size		Minimum Wall Thickness (mm)	Cable Diameter (mm)		Max. Weight (kg/km)	Max Resistance @ 20°C (Ohms/km)	Max. Transfer Impedance (mOhms/m)	
					AWG	Nom. (mm)		Min.	Max.			@ 10MHz	@ 30MHz
VG95218T028E007	15	5 x 3 x 0.40	007	1 VG95218T023G013	34	0.160	34	0.160	0.80	11.6	12.8	328	53.0
				VG95218T028E007									
				VG95218T028E007									
VG95218T028E009	36	12 x 3 x 0.40	009	2 VG95218T023G013	32	0.203	32	0.203	0.90	16.5	18.3	624	56.0
				VG95218T028E009									
				VG95218T028E009									

NOTES:

- VG descriptions in table are only available with a Black jacket.
- Component/s for the above cables shall be as listed under "Component" column. e.g. Components for VG95218T028E007 shall be VG95218T023G013, VG95218T023G014 & VG95218T023G015.
- Fillers are used as required.
- Values are for guidance only, refer to drawings for maintained product information.

TABLE COLOR KEY:

- System 25
- System 100
- System 200

VG 95218 Part 28 Type E



VG 95218 T028 E (LFMSGSSGO) – Multi Core, Shielded Wrapped Twisted Triples, Double Overall Shielded & Jacketed Cable

Component Identification

5-triple & 12-triple

- 1st triple: Black, White, Grey. Element coding (Wrap color): Red (Pilot and Direction)
- 2nd triple: Black, White, Grey. Element coding (Wrap color): Green (Counting Direction)
- 3rd pair: Black, White, Grey. Element coding (Wrap color): Clear

Position of pair colors and direction applicable to every cable layer.

Cable Jacket Identification

- The mark shall be: **Raychem - VG 95218 T028 E### - K1010 - VDE Reg.Nr. 7708 - LFMSGSSGO - (XXX)**
 where: "###" = VG Dash No.
 where: "XXX" = No. of Wires x Cross Sectional Area (mm²)
 e.g: VG95218T028E007 shall be marked: **Raychem - VG95218T028E007 - K1010 - VDE Reg.Nr. 7708 - LFMSGSSGO - (5x3x0.4)**

VG Part Description

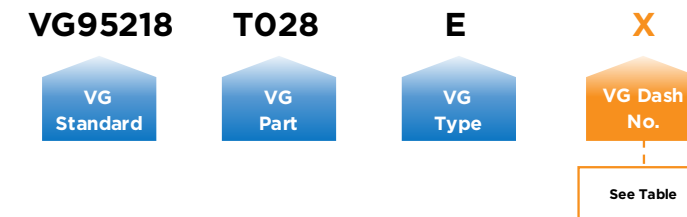

Example:

VG95218T028E007 : 12 x 3 x 0.40mm² conductors, 1st triple; Black, White, Grey with Red wrap, 2nd triple; Black, White, Grey with Green wrap, remaining triples; Black, White, Grey with Clear wrap & Overall Black Jacket

VG 95218 Part 28 Type E



VG 95218 T028 E - Multi Core, Various components, Overall Double Shielded & Jacketed Cable

- **Construction:** Various VG95218T020E (Primaries), VG95218T021C (Pairs), VG95218T023C (Screened Jacketed Triples) elements, overall wrap, double shield isolated with double wrap and jacket
- **Conductor:** Stranded tin-coated copper - 0.15mm², 0.25mm², 0.40mm², 1.20mm²
- **Insulation:** Halogen Free Polymer (Primary & Primary jacket)
- **Wrap:** Polyester (Overall)
- **Shield Material/Type:** Tin-coated copper / Optimized Woven Shield
- **Overall Jacket:** Zerohal jacketing material
- **Temperature Rating:** -40°C to +105°C
- **Voltage Rating:** 600V AC / 900V DC

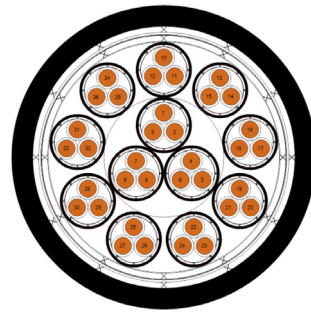

Illustrative Image - VG95218T028E003 example

System
100

Halogen
Free

600V
AC

-40°C
+105°C

Product Information Table

Part Description	No. of wires	No. of Wires x Cross Sectional Area (mm ²)	VG Dash No.	Component	Screen 1 - Strand Size		Screen 2 - Strand Size		Minimum Wall Thickness (mm)	Cable Diameter (mm)		Max. Weight (kg/km)	Max Resistance @ 20°C (Ohms/km)	Max. Transfer Impedance (mOhms/m)		Nato Stock Number 6145-12-
					AWG	Nom. (mm)	AWG	Nom. (mm)		Min.	Max.			@ 10MHz	@ 30MHz	
VG95218T028E001	2	2 x 1.20	001	VG95218T020E079	36	0.127	36	0.127	0.90	7.1	7.9	114	15.8	15	10	---
VG95218T028E002	13	5 x 0.25	002	VG95218T020E019	36	0.127	36	0.127	0.90	8.8	9.8	155	87.0	15	10	---
		VG95218T021C034		143.5									15	10	---	
VG95218T028E003	36	12 x 3 x 0.40	003	VG95218T023C013	32	0.203	32	0.203	1.09	20.8	23.0	889	55.3	15	5	---

- NOTES:**
- VG descriptions in table are only available with a Black jacket.
 - Component/s for the above cables shall be as listed under "Component" column. e.g. Components for VG95218T028E001 shall be VG95218T020E079.
 - Fillers are used as required.
 - Values are for guidance only, refer to drawings for maintained product information.

TABLE COLOR KEY:

	System 25
	System 100
	System 200

VG 95218 Part 28 Type E



VG 95218 T028 E - Multi Core, Various components, Overall Double Shielded & Jacketed Cable

Component Identification

- **1-Pair**
 - Primary wire - White, Numbered
- **5-Wire & 4 Pair**
 - Primary wire - White, Numbered
 - Pairs - White, Numbered
- **12-Triple**
 - Screened, Jacketed Triples - White, Numbered wires

Cable Jacket Identification

- The mark shall be: **Raychem - VG 95218 T028 E### - K1010 - VDE Reg.Nr. 7708** where: "###" = VG Dash No. e.g. VG95218T028E001 shall be marked: **Raychem - VG95218T028E001 - K1010 - VDE Reg.Nr. 7708**
- Color of mark shall be white.

VG Part Description

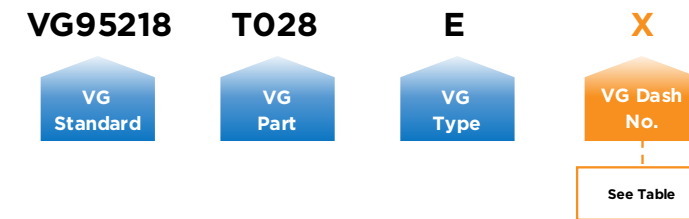

Example:
VG95218T028E001 : 2 x 1.20mm² conductors, White, numbered & Overall Black Jacket

T020
T021
T022
T023
T024
T025
T027
T028
T061 to 66

T020
T021
T022
T023
T024
T025
T027
T028
T061 to 66

VG 95218 T061 to T066



The VG95218 Part 28 Types C and E series covers halogen free cables with a low fire hazard. It has been developed in accordance with state-of-the-art cabling techniques using thin-wall insulation for primary wires and an optimized cable design process in the interest of minimum weight and diameter.

Through technical improvement, a crucial development step was achieved with the VG95218 parts C and E standard series which reflects both new requirements in shipbuilding and empirical values from the past.

- Significantly increased service life
- Long-term resistance to environmental influences
- Increased EMC requirements

The range of tests for cables according to VG95218 Part 28 Types C and E was adapted to the requirements of modern marine equipment.

In addition to electrical and mechanical requirements, it also fulfills the specifications for limiting fire hazards thanks to the following properties:

- Halogen free
- Flame retarded
- Low corrosivity of combustion gases
- Low toxicity of combustion gases
- Low smoke generation - See below table

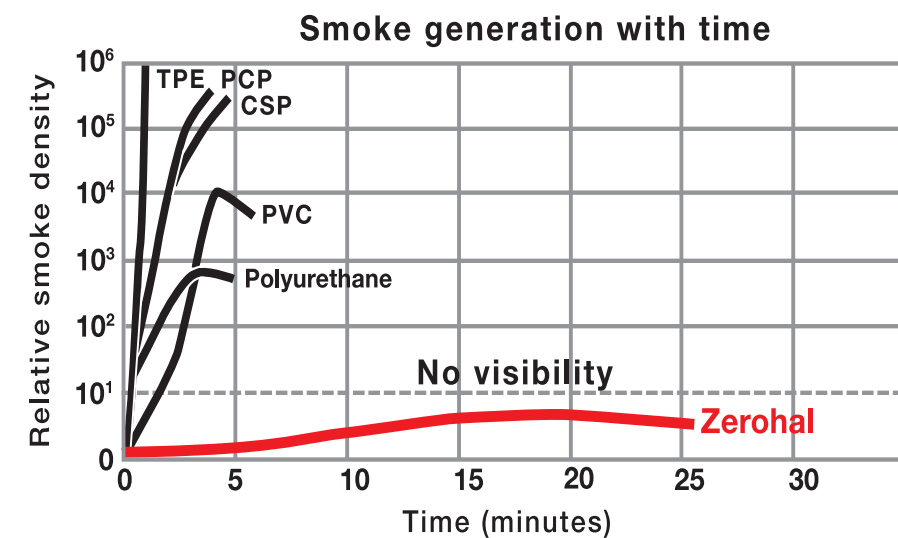

VG 95218 T061 to T066



Thin-Wall Technology Allows You to Do More with Less

Compared to Parts 61 to 66 cables, VG 95218 Part 28 Type C and E cables provide the following benefits from an installation viewpoint:

Smaller Size

- Installs quicker into the vessel or module (customer installations have shown that the cables can be routed 30% faster than traditional cable)
- Permits tighter bend radii.
- Requires smaller cable tray and ancillaries (which also reduce installation time and physical purchase cost)
- Allows more equipment to be connected within the same space.

Reduced Weight

- Delivers more freedom to provide additional production equipment on the installation.
- Allows more densely populated installations on cable trays designed for traditional cable products.
- May allow the use of less steel in the superstructure or allow higher design safety margins.

TE's thin-wall technology can save as much as 40% in cable trays. Such savings result in smaller trays, more cables per tray, lighter supports, and smaller cable glands. And higher temperature ratings mean higher current densities, increased safety, and long-term reliability.

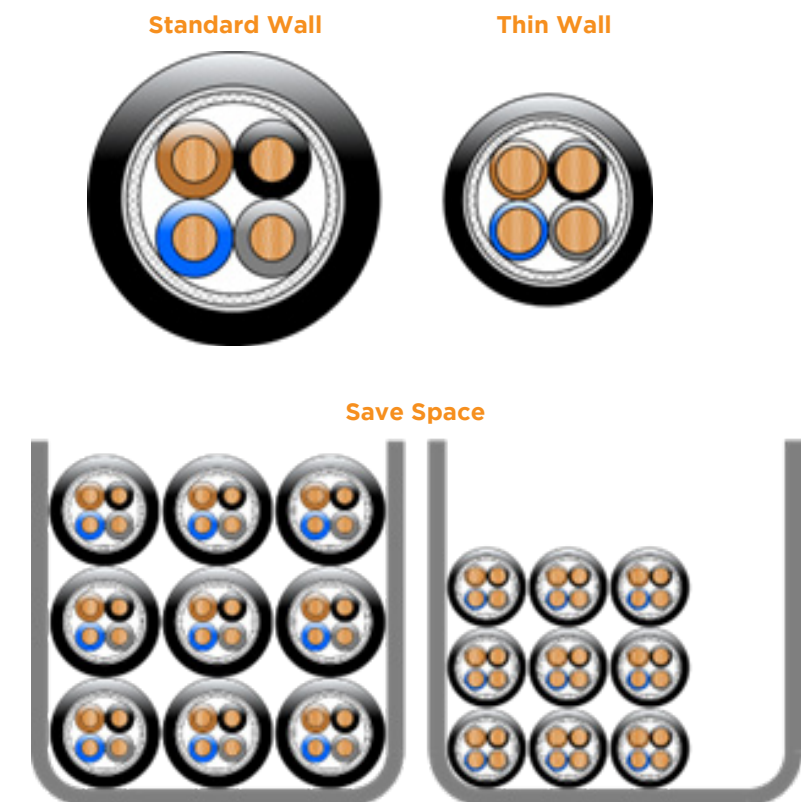

VG 95218 T061 to T066



Cross-Reference List for VG95218 parts 61 to 66

The following tables are a cross reference for Part 28 alternatives to Part 61 thru 66.

Number of Wires x Nominal Cross-Section	New VG Numbers VG 95218 T028	Old VG Numbers VG 95218 T061 to T066
LMGSGO	T028	T061
(2 x 1.5)	C033 (old), C083 (new)*	A001 (old), A019 (new)
(3 x 1.5)	C035 (old), C122 (new)*	A002 (old), A021 (new)
(4 x 1.5)	C042 (old), C088 (new)*	A003 (old), A025 (new)
(5 x 1.5)	C044 (old), C090 (new)*	A004 (old), A027 (new)
(7 x 1.5)	C046	A005
(10 x 1.5)	C052	A006
(12 x 1.5)	C055	A007
(14 x 1.5)	C058	A008
(16 x 1.5)	C060	A009
(19 x 1.5)	C061	A010
(24 x 1.5)	C065	A011
(27 x 1.5)	C066	A012
(33 x 1.5)	C070	A013
(37 x 1.5)	C005	A018
(3G1.5)	C036 (old), C085 (new)*	A102 (old), A022 (new)
(5G1.5)	C045 (old), C091 (new)*	A104 (old), A028 (new)
(7G1.5)	C047	A105
(10G1.5)	C053	A106
(2 x 2.5)	C034 (old), C084 (new)*	A014 (old), A020 (new)
(3 x 2.5)	C037 (old), C086 (new)*	A015 (old), A023 (new)
(4 x 2.5)	C043 (old), C089 (new)*	A016 (old), A026 (new)
(7 x 2.5)	C048	A017
(3G2.5)	C038 (old), C087 (new)*	A115 (old), A024 (new)

FMGSGO	T028	T062
(1 x 2 x 0.75)	C032 (old), C082 (new)*	A008
(2 x 2 x 0.75)	C040	A001
(4 x 2 x 0.75)	C050	A002
(6 x 2 x 0.75)	C054	A003
(8 x 2 x 0.75)	C059	A004
(10 x 2 x 0.75)	C062	A005
(14 x 2 x 0.75)	C067	A006
(16 x 2 x 0.75)	C069	A007
(1 x 2 x 1.0)	C092	A009
(2 x 2 x 1.0)	C099	A010
(4 x 2 x 1.0)	C104	A011
(6 x 2 x 1.0)	C106	A012
(8 x 2 x 1.0)	C108	A013
(10 x 2 x 1.0)	C109	A014
(14 x 2 x 1.0)	C111	A015
(16 x 2 x 1.0)	C113	A016

NOTES:

* Harmonization on the European market was implemented as a result of a change in wire color harmonization on the basis of DIN VDE 0293-308. This also necessitated a modification of VG Kabel.

VG 95218 T061 to T066



Cross-Reference List for VG95218 parts 61 to 66

The following tables are a cross reference for Part 28 alternatives to Part 61 thru 66.

Number of Wires x Nominal Cross-Section	New VG Numbers VG 95218 T028	Old VG Numbers VG 95218 T061 to T066
FMSGGO	T028	T063
(1 x 2 x 0.75)	C032 (old), C082 (new)*	A008
(2 x 2 x 0.75)	C040	A001
(4 x 2 x 0.75)	C050	A002
(6 x 2 x 0.75)	C054	A003
(8 x 2 x 0.75)	C059	A004
(10 x 2 x 0.75)	C062	A005
(14 x 2 x 0.75)	C067	A006

LFMGSSGO	T028	T064
(1 x 2 x 0.75)	C032 (old), C082 (new)*	A008
(2 x 2 x 0.75)	C040	A001
(4 x 2 x 0.75)	C050	A002
(6 x 2 x 0.75)	C054	A003
(8 x 2 x 0.75)	C059	A004
(10 x 2 x 0.75)	C062	A005
(14 x 2 x 0.75)	C067	A006
(16 x 2 x 0.75)	C069	A007

LFMGSSGO	T028	T064
(1 x 2 x 0.75)	C032 (old), C082 (new)*	A008
(2 x 2 x 0.75)	C040	A001
(4 x 2 x 0.75)	C050	A002
(6 x 2 x 0.75)	C054	A003
(8 x 2 x 0.75)	C059	A004
(10 x 2 x 0.75)	C062	A005
(14 x 2 x 0.75)	C067	A006
(16 x 2 x 0.75)	C069	A007
(1 x 2 x 1.0)	C092	A009
(2 x 2 x 1.0)	C099	A010
(4 x 2 x 1.0)	C104	A011
(6 x 2 x 1.0)	C106	A012
(8 x 2 x 1.0)	C108	A013

LFMGSSGO	T028	T065
(2 x 2 x 0.4)	C039	A001
(4 x 2 x 0.4)	C049	A002
(7 x 2 x 0.4)	C056	A003
(12 x 2 x 0.4)	C064	A004
(19 x 2 x 0.4)	C071	A005
(27 x 2 x 0.4)	C075	A006
(3 x 2 x 1.2 und 18 x 2 x 0.25)	C073	B001
(27 x 4 x 0.25)	C078	C001

LFMGSSGO	T028	T066
(5 x 3 x 0.4)	E007	A001
(12 x 3 x 0.4)	E009	A002

NOTES:

* Harmonization on the European market was implemented as a result of a change in wire color harmonization on the basis of DIN VDE 0293-308. This also necessitated a modification of VG Kabel.



Introduction

Heat-shrink System 25, System 100, and System 200 components are certified under VG 95343 and TE's Raybraid RAY-90 and RAY-101 EMI shielding components are certified under VG 96936.

Using the pioneering cross linking technology developed by TE's material scientists to enhance material performance, our heat-shrink products meet global military specifications and provide protection solutions in challenging environments and demanding applications world-wide. This section outlines the portfolio of Raychem heat shrinkable components and adhesives under VG 95343 and also our Raybraid metal braid products under VG 96936.

The product range includes

- [VG 95343 Part 05 Heat Shrink Tube](#)
- [VG 95343 Part 06 Molded Parts](#)
- [VG 95343 Part 07 Molded Parts](#)
- [VG 95343 Part 08 Transition Molded Parts](#)
- [VG 95343 Part 09 Transition Molded Parts](#)
- [VG 95343 Part 15 Adhesive](#)
- [VG 95343 Part 18 Molded Parts](#)
- [VG 95343 Part 19 Transition Molded Parts](#)
- [VG 95343 Part 19 Transition Molded Parts](#)
- [VG 95343 Part 25 Feedthrough Molded Parts](#)
- [VG 95343 Part 28 Zerohal Molded Parts](#)
- [VG 95343 Part 29 Zerohal Molded Parts](#)
- [VG 95343 Part 30 Zerohal Transition Molded Parts](#)



VG 95343 Part 05 Heat Shrink Tube



Our high-performance heat shrinkable tubing products are designed to meet harsh environments required by most ruggedized harness designs. The use of TE's Raychem harnessing tubing allows simple design and cost effective custom harnesses. Our heat shrink tubings are made of polyolefins, fluoropolymers, or elastomers enhanced by radiation crosslinking and heat-shrinkability. When heated during installation, our tubings shrink to conform to many shapes. They provide dependable insulation, mechanical protection, and strain relief, as well as aesthetic appeal. Your choice of tubing type will depend upon your application, and your application requirements. For more details, please contact your TE representative.

VG 95343 T05 D

VG Part Reference	TE Part Description	TE Part Number
VG 95343 T05 D001 A	DR-25-1/8-0-SP	5039324007
VG 95343 T05 D002 A	DR-25-3/16-0-SP	5039294018
VG 95343 T05 D003 A	DR-25-1/4-0-SP	5039274019
VG 95343 T05 D004 A	DR-25-3/8-0-SP	5039264026
VG 95343 T05 D005 A	DR-25-1/2-0-SP	5039304024
VG 95343 T05 D006 A	DR-25-3/4-0-SP	5039254029
VG 95343 T05 D007 A	DR-25-1-0-SP	5039244037
VG 95343 T05 D008 A	DR-25-1 1/2-0-SP	5039234011
VG 95343 T05 D009 A	DR-25-2-0-SP	5039314011
VG 95343 T05 D010 A	DR-25-3-0-SP	5039364006
VG 95343 T05 D011 A	DR-25-4-0-SP	4017984001
VG 95343 T05 D012 A	DR-25-TW-3/32-0-SP	6504744001
VG 95343 T05 D013 A	DR-25-TW-1/8-0-SP	6458864001
VG 95343 T05 D014 A	DR-25-TW-3/16-0-SP	4816334002
VG 95343 T05 D015 A	DR-25-TW-1/4-0-SP	4568604002
VG 95343 T05 D016 A	DR-25-TW-3/8-0-SP	9088924002
VG 95343 T05 D017 A	DR-25-TW-1/2-0-SP	9908044002
VG 95343 T05 D018 A	DR-25-TW-3/4-0-SP	5750464002
VG 95343 T05 D019 A	DR-25-TW-1-0-SP	7223184002
VG 95343 T05 D020 A	DR-25-TW-1 1/2-0-SP	8895704002
VG 95343 T05 D021 A	DR-25-TW-1 1/4-0-SP	1707854001

VG 95343 T05 E

VG Part Reference	TE Part Description	TE Part Number
VG 95343 T05 E001 A	RW-200-E-1/8-0-SP	CB03294012
VG 95343 T05 E002 A	RW-200-E-3/16-0-SP	CB03314003
VG 95343 T05 E003 A	RW-200-E-1/4-0-SP	CB03334007
VG 95343 T05 E004 A	RW-200-E-3/8-0-SP	CB03354011
VG 95343 T05 E005 A	RW-200-E-1/2-0-SP	CB03374007
VG 95343 T05 E006 A	RW-200-E-3/4-0-SP	CB03394012
VG 95343 T05 E007 A	RW-200-E-1-0-SP	CB03434010
VG 95343 T05 E008 A	RW-200-E-1 1/2-0-SP	CB03454006
VG 95343 T05 E009 A	RW-200-E-2-0-SP	CB03464001

VG 95343 T05 L

VG Part Reference	TE Part Description	TE Part Number
VG 95343 T05 L001 A	ZHTM-3/1.5-0-SP	2411034003
VG 95343 T05 L002 A	ZHTM-5/2.5-0-SP	2023374003
VG 95343 T05 L003 A	ZHTM-8/4-0-SP	6649664003
VG 95343 T05 L004 A	ZHTM-12/6-0-SP	2155384003
VG 95343 T05 L005 A	ZHTM-18/9-0-SP	2109474003
VG 95343 T05 L006 A	ZHTM-24/12-0-SP	4611264003
VG 95343 T05 L007 A	ZHTM-40/20-0-SP	2450984003
VG 95343 T05 L008 A	ZHTM-50/30-0-SP	2596914002

DR-25 & DR-25-TW

- System 25 tubing
- Flame Retardant
- Shrink ratio 2:1
- RoHS compliant
- Operating Temperature Range -75°C to +150°C
- TW (thin wall) version available for weight and space saving
- Good mechanical strength
- Resistant to aviation and diesel fuels, hydraulic fluids and lubricating oils

ZHTM

- System 100 tubing
- Halogen free and Low Fire Hazard
- Excellent fire safety characteristics
- Low smoke emission
- Low evolution of acid gases
- Shrink Ratio 2:1
- RoHS compliant
- Operating Temperature Range -40°C to +105°C
- Good resistance to fluids

RW-200-E

- RW-200-E heat shrink tubing is part of our System 200 high temperature fluid resistant product portfolio, to be used in conjunction with our 200°C rated VG wire and cable products
- High resistance to impact and abrasion
- Resistant to a wide variety of aviation and other fuels, lubricants, acids and solvents at elevated temperatures
- Good flexibility at low temperatures
- RoHS compliant
- Shrink Ratio 2:1

TABLE COLOR KEY:

- System 25
- System 100
- System 200

- T05
- T06
- T07
- T08
- T09
- T15
- T18
- T19
- T25
- T28
- T29
- T30

VG 95343 Part 06 Molded Parts



TE's heat shrinkable molded boots in -25 elastomeric molding compound and -12 high temperature molding compound provide a tough, semi-rigid, fluid and temperature resistant interface between connector adaptor backshells and harness cabling. Designed to offer excellent performance in harsh environments, when used with VG qualified adhesive, these boots will seal and help protect from fluid and dust ingress. They are ideal for use in military vehicles where high temperatures and long exposure to fluids is expected.

202D211 to 299

As Supplied



After Unrestricted Recovery



222K121 to 185

As Supplied



After Unrestricted Recovery

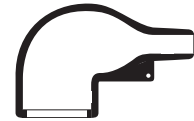

202K121 to 185

As Supplied

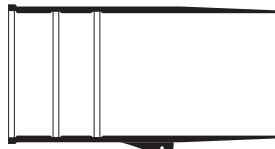

After Unrestricted Recovery

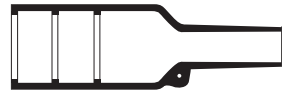

202D121 to 196

As Supplied

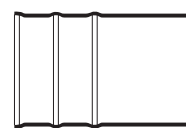

After Unrestricted Recovery



222K1**-12

As Supplied

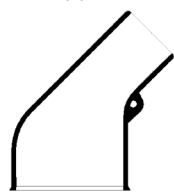

After Unrestricted Recovery



VG 95343 Part 06 Molded Parts



222D211 to 299

As Supplied



After Unrestricted Recovery

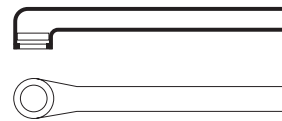

222D921 to 963

As Supplied

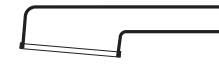

After Unrestricted Recovery

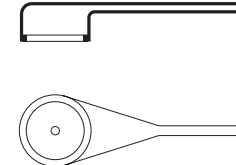

214A011 to 052

As Supplied

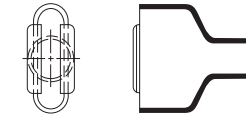

After Unrestricted Recovery

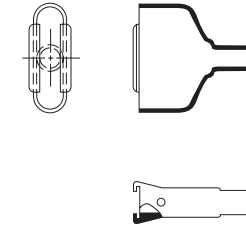

214A311 to 352

As Supplied



After Unrestricted Recovery

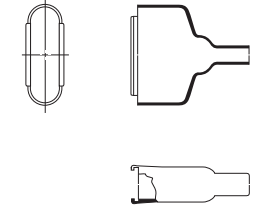

VG 95343 T06 A

VG Part Reference	TE Part Description	TE Part Number
VG 95343 T06 A001 A	202K121-25-01-0	878501-000
VG 95343 T06 A002 A	202K232-25-01-0	878443-000
VG 95343 T06 A003 A	202K132-25-01-0	878502-000
VG 95343 T06 A004 A	202K142-25-01-0	878503-000
VG 95343 T06 A005 A	202K153-25-01-0	878504-000
VG 95343 T06 A006 A	202K163-25-02-0	878508-000
VG 95343 T06 A007 A	202K174-25-02-0	878509-000
VG 95343 T06 A008 A	202K185-25-02-0	878510-000
VG 95343 T06 A009 A	202D196-25-10-0	868781-000
VG 95343 T06 A010 A	203W112-25-0	359651-000

VG 95343 T06 B

VG Part Reference	TE Part Description	TE Part Number
VG 95343 T06 B001 A	202K121-25-0	878494-000
VG 95343 T06 B002 A	202K232-25-0	878798-000
VG 95343 T06 B003 A	202K132-25-0	878495-000
VG 95343 T06 B004 A	202K142-25-0	878496-000
VG 95343 T06 B005 A	202K153-25-0	878497-000
VG 95343 T06 B006 A	202K163-25-01-0	878505-000
VG 95343 T06 B007 A	202K174-25-01-0	878506-000
VG 95343 T06 B008 A	202K185-25-01-0	878507-000
VG 95343 T06 B009 A	202D196-25-08-0	019621-000

VG 95343 T06 C

VG Part Reference	TE Part Description	TE Part Number
VG 95343 T06 C001 A	202K163-25-0	878498-000
VG 95343 T06 C002 A	202K174-25-0	878499-000
VG 95343 T06 C003 A	202K185-25-0	878500-000
VG 95343 T06 C004 A	202D196-25-0	595543-000

VG 95343 T06 D

VG Part Reference	TE Part Description	TE Part Number
VG 95343 T06 D001 A	202D211-25-22-0	806695-000
VG 95343 T06 D002 A	202D221-25-22-0	806893-000
VG 95343 T06 D003 A	202D232-25-22-0	806894-000
VG 95343 T06 D004 A	202D242-25-22-0	806895-000
VG 95343 T06 D005 A	202D253-25-22-0	806896-000
VG 95343 T06 D006 A	202D263-25-22-0	806897-000
VG 95343 T06 D007 A	202D274-25-22-0	806910-000
VG 95343 T06 D008 A	202D285-25-22-0	385741-000
VG 95343 T06 D009 A	202D296-25-22-0	on application
VG 95343 T06 D010 A	202D299-25-22-0	on application
VG 95343 T06 D011 A	202D921-25-0	806438-000
VG 95343 T06 D012 A	202D932-25-0	806808-000
VG 95343 T06 D013 A	202D953-25-0	806684-000
VG 95343 T06 D014 A	202D963-25-0	806709-000

TABLE COLOR KEY:

- System 25
- System 100
- System 200



VG 95343 Part 06 Molded Parts

VG 95343 T06 E

VG Part Reference	TE Part Description	TE Part Number
VG 95343 T06 E001 A	222K121-25-0	878511-000
VG 95343 T06 E002 A	222K132-25-0	878512-000
VG 95343 T06 E003 A	222K142-25-0	878513-000
VG 95343 T06 E004 A	222K152-25-0	878514-000
VG 95343 T06 E005 A	222K163-25-0	878515-000
VG 95343 T06 E006 A	222K174-25-0	878516-000
VG 95343 T06 E007 A	222K185-25-0	878517-000
VG 95343 T06 E008 A	222D196-25-0	806867-000

VG 95343 T06 F

VG Part Reference	TE Part Description	TE Part Number
VG 95343 T06 F001 A	222D211-25-22-0	806887-000
VG 95343 T06 F002 A	222D221-25-22-0	806888-000
VG 95343 T06 F003 A	222D232-25-22-0	806881-000
VG 95343 T06 F004 A	222D242-25-22-0	806889-000
VG 95343 T06 F005 A	222D253-25-22-0	806890-000
VG 95343 T06 F006 A	222D263-25-22-0	806891-000
VG 95343 T06 F007 A	222D274-25-22-0	806892-000
VG 95343 T06 F008 A	222D285-25-22-0	on application
VG 95343 T06 F009 A	222D296-25-22-0	on application
VG 95343 T06 F010 A	222D299-25-22-0	on application
VG 95343 T06 F011 A	222D921-25-0	806686-000
VG 95343 T06 F012 A	222D932-25-0	806806-000
VG 95343 T06 F013 A	222D953-25-0	806687-000
VG 95343 T06 F014 A	222D963-25-0	806605-000

VG 95343 T06 G

VG Part Reference	TE Part Description	TE Part Number
VG 95343 T06 G001 A	207K113-25-0	879129-000

VG 95343 T06 H

VG Part Reference	TE Part Description	TE Part Number
VG 95343 T06 H001 A	267K113-25-0	879257-000
VG 95343 T06 H002 A	267K023-25-0	879255-000

VG 95343 T06 J

VG Part Reference	TE Part Description	TE Part Number
VG 95343 T06 J001 A	228A011-25-0	183024-000
VG 95343 T06 J002 A	228A021-25-0	249937-000
VG 95343 T06 J003 A	228A032-25-0	875480-000
VG 95343 T06 J004 A	228A042-25-0	806807-000
VG 95343 T06 J005 A	228A053-25-0	286906-000
VG 95343 T06 J006 A	228A064-25-0	523514-000
VG 95343 T06 J007 A	228A075-25-0	on application
VG 95343 T06 J008 A	228A086-25-0	on application
VG 95343 T06 J009 A	228A097-25-0	on application

VG 95343 T06 K

VG Part Reference	TE Part Description	TE Part Number
VG 95343 T06 K001 A	214A011-25-0	806792-000
VG 95343 T06 K002 A	214A021-25-0	806685-000
VG 95343 T06 K003 A	214A032-25-0	806677-000
VG 95343 T06 K004 A	214A042-25-0	806793-000
VG 95343 T06 K005 A	214A052-25-0	806794-000
VG 95343 T06 K006 A	214A311-25-0	806691-000
VG 95343 T06 K007 A	214A321-25-0	806692-000
VG 95343 T06 K008 A	214A332-25-0	806795-000
VG 95343 T06 K009 A	214A342-25-0	879436-000
VG 95343 T06 K010 A	214A352-25-0	806796-000

VG 95343 T06 L

VG Part Reference	TE Part Description	TE Part Number
VG 95343 T06 L001 A	234A011 - 25 - 0	806808-000
VG 95343 T06 L002 A	234A021 - 25 - 0	806809-000
VG 95343 T06 L003 A	234A032 - 25 - 0	806810-000
VG 95343 T06 L004 A	234A042 - 25 - 0	806861-000
VG 95343 T06 L005 A	234A052 - 25 - 0	806811-000
VG 95343 T06 L006 A	234A611 - 25 - 0	879393-000
VG 95343 T06 L007 A	234A621 - 25 - 0	806817-000
VG 95343 T06 L008 A	234A632 - 25 - 0	806818-000
VG 95343 T06 L009 A	234A652 - 25 - 0	806949-000

TABLE COLOR KEY:

- System 25
- System 100
- System 200



VG 95343 Part 06 Molded Parts

VG 95343 T06 M

VG Part Reference	TE Part Description	TE Part Number
VG95343T06M001A	202D921-12-0	811183-000
VG95343T06M002A	202D221-12-22-0	811359-000
VG95343T06M003A	202D221-12-22-0	811359-000
VG95343T06M004A	202D932-12-0	808081-000
VG95343T06M005A	202D242-12-22-0	811303-000
VG95343T06M006A	202D953-12-0	808082-000
VG95343T06M007A	202D253-12-22-0	811210-000
VG95343T06M008A	202D263-12-22-0	811304-000
VG95343T06M009A	202D963-12-0	808744-000
VG95343T06M010A	202D274-12-22-0	444773-000

VG 95343 T06 N

VG Part Reference	TE Part Description	TE Part Number
VG95343T06N001A	222D921-12-0	811197-000
VG95343T06N002A	222D221-12-22-0	811432-000
VG95343T06N003A	222D232-12-22-0	807975-000
VG95343T06N004A	222D932-12-0	808083-000
VG95343T06N005A	222D242-12-22-0	811305-000
VG95343T06N006A	222D953-12-0	738010-000
VG95343T06N007A	222D253-12-22-0	305728-000
VG95343T06N008A	222D263-12-22-0	811306-000
VG95343T06N009A	222D963-12-0	811324-000
VG95343T06N010A	222D274-12-22-0	D23077-000

VG 95343 T06 P

VG Part Reference	TE Part Description	TE Part Number
VG95343T06P001A	222K121-12-0	878274-000
VG95343T06P002A	222K132-12-0	878183-000
VG95343T06P003A	222K142-12-0	878184-000
VG95343T06P004A	222K152-12-0	879505-000
VG95343T06P005A	222K163-12-0	811943-000
VG95343T06P006A	222K174-12-0	012760-000
VG95343T06P007A	222K185-12-0	878145-000
VG95343T06N008A	222D263-12-22-0	811306-000

TABLE COLOR KEY:

- System 25
- System 100
- System 200



VG 95343 Part 07 Molded Parts



TE's heat shrinkable transitions in -25 elastomeric molding compound provide tough, semi-rigid, fluid and temperature resistant cable and harness breakouts. Designed to offer excellent performance in harsh environments, when used with VG qualified adhesive, these boots will seal and help protect from fluid and dust ingress. They are ideal for use in military vehicles where high temperatures and long exposure to fluids is expected.

202K121 to 185

As Supplied

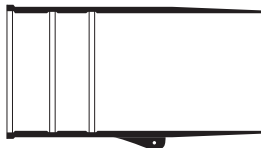

After Unrestricted Recovery



222K121 to 185

As Supplied



After Unrestricted Recovery



202D121 to 196

As Supplied

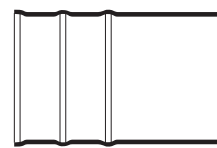

After Unrestricted Recovery



222D121 to 299

As Supplied



After Unrestricted Recovery

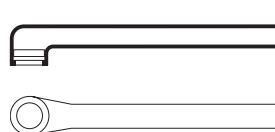

202D211 to 299

As Supplied



After Unrestricted Recovery



VG 95343 Part 07 Molded Parts

VG 95343 T07 A

VG Part Reference	TE Part Description	TE Part Number
VG 95343 T07 A001 A	202K121-25-11-0	On Application
VG 95343 T07 A002 A	202K232-25-11-0	952223-000
VG 95343 T07 A003 A	202K132-25-11-0	304850-000
VG 95343 T07 A004 A	202K142-25-11-0	620409-000
VG 95343 T07 A005 A	202K153-25-11-0	164047-000
VG 95343 T07 A006 A	202K163-25-12-0	On Application
VG 95343 T07 A007 A	202K174-25-12-0	On Application
VG 95343 T07 A008 A	202K185-25-12-0	On Application
VG 95343 T07 A009 A	202D196-25-04-0	983241-000

VG 95343 T07 B

VG Part Reference	TE Part Description	TE Part Number
VG 95343 T07 B001 A	202K121-25-00-0	879498-000
VG 95343 T07 B002 A	202K232-25-00-0	253127-000
VG 95343 T07 B003 A	202K132-25-00-0	632774-000
VG 95343 T07 B004 A	202K142-25-00-0	879228-000
VG 95343 T07 B005 A	202K153-25-00-0	879459-000
VG 95343 T07 B006 A	202K163-25-11-0	194953-000
VG 95343 T07 B007 A	202K174-25-11-0	522807-000
VG 95343 T07 B008 A	202K185-25-11-0	CV5811-000
VG 95343 T07 B009 A	202D196-25-03-0	On Application

VG 95343 T07 C

VG Part Reference	TE Part Description	TE Part Number
VG 95343 T07 C001 A	202K163-25-00-0	898768-000
VG 95343 T07 C002 A	202K174-25-00-0	879499-000
VG 95343 T07 C003 A	202K185-25-00-0	101910-000
VG 95343 T07 C004 A	202D196-25-00-0	On Application

VG 95343 T07 D

VG Part Reference	TE Part Description	TE Part Number
VG 95343 T07 D001 A	202D211-25-32-0	On Application
VG 95343 T07 D002 A	202D221-25-32-0	On Application
VG 95343 T07 D003 A	202D232-25-32-0	On Application
VG 95343 T07 D004 A	202D242-25-32-0	On Application
VG 95343 T07 D005 A	202D253-25-32-0	169784-000
VG 95343 T07 D006 A	202D263-25-32-0	On Application
VG 95343 T07 D007 A	202D274-25-32-0	On Application
VG 95343 T07 D008 A	202D285-25-32-0	On Application
VG 95343 T07 D009 A	202D296-25-32-0	On Application
VG 95343 T07 D010 A	202D299-25-32-0	On Application

VG 95343 T07 E

VG Part Reference	TE Part Description	TE Part Number
VG 95343 T07 E001 A	222K121-25-00-0	879501-000
VG 95343 T07 E002 A	222K132-25-00-0	895514-000
VG 95343 T07 E003 A	222K142-25-00-0	879263-000
VG 95343 T07 E004 A	222K152-25-00-0	879493-000
VG 95343 T07 E005 A	222K163-25-00-0	879494-000
VG 95343 T07 E006 A	222K174-25-00-0	879500-000
VG 95343 T07 E007 A	222K185-25-00-0	879489-000
VG 95343 T07 E008 A	222D196-25-00-0	On Application

VG 95343 T07 F

VG Part Reference	TE Part Description	TE Part Number
VG 95343 T07 F001 A	222D211-25-32-0	On Application
VG 95343 T07 F002 A	222D221-25-32-0	On Application
VG 95343 T07 F003 A	222D232-25-32-0	On Application
VG 95343 T07 F004 A	222D242-25-32-0	957299-000
VG 95343 T07 F005 A	222D253-25-32-0	On Application
VG 95343 T07 F006 A	222D263-25-32-0	On Application
VG 95343 T07 F006 A	222D263-25-32-0	On Application
VG 95343 T07 F007 A	222D274-25-32-0	030131-000
VG 95343 T07 F007 A	222D274-25-32-0	030131-000
VG 95343 T07 F008 A	222D285-25-32-0	On Application
VG 95343 T07 F009 A	222D296-25-32-0	On Application
VG 95343 T07 F010 A	222D299-25-32-0	On Application

TABLE COLOR KEY:

	System 25
	System 100
	System 200



VG 95343 Part 08 Transition Molded Parts



TE's heat shrinkable transitions in -25 elastomeric molding compound provide tough, semi-rigid, fluid and temperature resistant cable and harness breakouts. Designed to offer excellent performance in harsh environments, when used with VG qualified adhesive, these boots will seal and help protect from fluid and dust ingress. They are ideal for use in military vehicles where high temperatures and long exposure to fluids is expected.

322A112 to 158

As Supplied



After Unrestricted Recovery

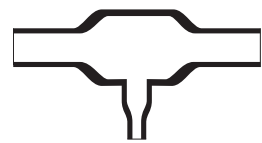

301A011 to 048

As Supplied

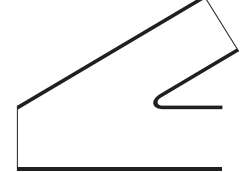

After Unrestricted Recovery

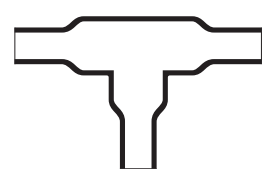

342A012 to 058

As Supplied



After Unrestricted Recovery



362A014 to 114

As Supplied



After Unrestricted Recovery



382A012 to 046

As Supplied



After Unrestricted Recovery

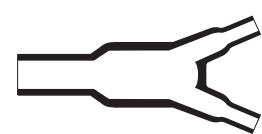

462A011 to 060

As Supplied



After Unrestricted Recovery

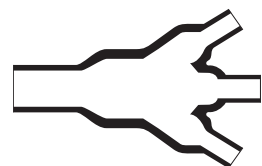

562A011 to 067

As Supplied

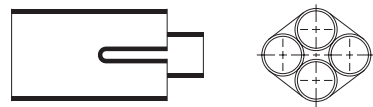

After Unrestricted Recovery

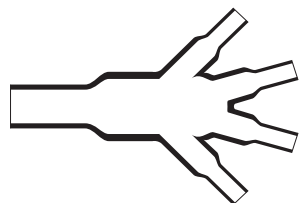

VG 95343 Part 08 Transition Molded Parts

VG 95343 T08 A

VG Part Reference	TE Part Description	TE Part Number
VG 95343 T08 A001 A	322A112-25-0	820057-000
VG 95343 T08 A002 A	322A134-25-0	820064-000
VG 95343 T08 A003 A	322A434-25-0	823695-000
VG 95343 T08 A004 A	322A123-25-0	823693-000
VG 95343 T08 A005 A	322A148-25-0	820196-000
VG 95343 T08 A006 A	322A158-25-0	820294-000
VG 95343 T08 A007 A	322A412-25-0	829098-000
VG 95343 T08 A008 A	322A423-25-0	820118-000
VG 95343 T08 A009 A	301A011-25-0	820091-000
VG 95343 T08 A010 A	301A022-25-0	820059-000
VG 95343 T08 A011 A	301A034-25-0	823692-000
VG 95343 T08 A012 A	301A048-25-0	820231-000
VG 95343 T08 A013 A	302A012-25-0	820117-000
VG 95343 T08 A014 A	302A024-25-0	820114-000
VG 95343 T08 A015 A	302A037-25-0	820108-000
VG 95343 T08 A016 A	322A012-25-0	820040-000
VG 95343 T08 A017 A	322A024-25-0	820041-000
VG 95343 T08 A018 A	322A037-25-0	820092-000

VG 95343 T08 B

VG Part Reference	TE Part Description	TE Part Number
VG 95343 T08 B001 A	342A012-25-0	878518-000
VG 95343 T08 B002 A	342A034-25-0	820078-000
VG 95343 T08 B003 A	362A014-25-0	820131-000
VG 95343 T08 B004 A	342A024-25-0	829099-000
VG 95343 T08 B005 A	342A048-25-0	820148-000
VG 95343 T08 B006 A	342A058-25-0	926130-000
VG 95343 T08 B007 A	362A024-25-0	820132-000
VG 95343 T08 B008 A	362A114-25-0	820133-000
VG 95343 T08 B009 A	341A015-25-0	820287-000
VG 95343 T08 B010 A	342A112-25-0	829102-000
VG 95343 T08 B011 A	342A124-25-0	829103-000
VG 95343 T08 B012 A	342A138-25-0	820147-000

TABLE COLOR KEY:

- System 25
- System 100
- System 200

VG 95343 T08 C

VG Part Reference	TE Part Description	TE Part Number
VG 95343 T08 C001 A	382A012-25-0	820192-000
VG 95343 T08 C002 A	382A023-25-0	823696-000
VG 95343 T08 C003 A	382A034-25-0	820193-000
VG 95343 T08 C004 A	382A046-25-0	820120-000
VG 95343 T08 C005 A	342A215-25-0	823698-000

VG 95343 T08 D

VG Part Reference	TE Part Description	TE Part Number
VG 95343 T08 D001 A	462A011-25-0	820055-000
VG 95343 T08 D002 A	462A023-25-0	820056-000
VG 95343 T08 D003 A	462A034-25-0	820243-000
VG 95343 T08 D004 A	462A046-25-0	820121-000
VG 95343 T08 D005 A	462A060-25-0	204267-000

VG 95343 T08 E

VG Part Reference	TE Part Description	TE Part Number
VG 95343 T08 E001 A	562A011-25-0	820058-000
VG 95343 T08 E002 A	562A022-25-0	823811-000
VG 95343 T08 E003 A	562A032-25-0	829100-000
VG 95343 T08 E004 A	562A043-25-0	820094-000
VG 95343 T08 E005 A	562A054-25-0	820169-000
VG 95343 T08 E006 A	562A067-25-0	820301-000
VG 95343 T08 E007 A	561A017-25-0	896753-000
VG 95343 T08 F001 A	422A616-25-0	820135-000
VG 95343 T08 G001 A	422A011-25-0	on application
VG 95343 T08 G002 A	422A414-25-0	703802-000

VG 95343 Part 09 Transition Molded Parts



TE's heat shrinkable transitions in -25 elastomeric molding compound provide tough, semi-rigid, fluid and temperature resistant cable and harness breakouts. Designed to offer excellent performance in harsh environments, when used with VG qualified adhesive, these boots will seal and help protect from fluid and dust ingress. They are ideal for use in military vehicles where high temperatures and long exposure to fluids is expected.

322A112 to 158

As Supplied



After Unrestricted Recovery

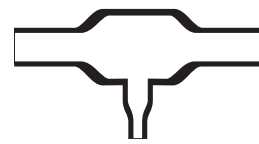

342A012 to 058

As Supplied



After Unrestricted Recovery



362A014 to 114

As Supplied



After Unrestricted Recovery



382A012 to 046

As Supplied



After Unrestricted Recovery



VG 95343 T09 A

VG Part Reference	TE Part Description	TE Part Number
VG 95343 T09 A001 A	322A112-25-00-0	On application
VG 95343 T09 A002 A	322A134-25-00-0	348167-000
VG 95343 T09 A003 A	322A434-25-00-0	On application

VG 95343 T09 B

VG Part Reference	TE Part Description	TE Part Number
VG 95343 T09 B001 A	342A012-25-00-0	On application
VG 95343 T09 B002 A	342A034-25-00-0	951566-000
VG 95343 T09 B003 A	362A014-25-00-0	On application

VG 95343 T09 C

VG Part Reference	TE Part Description	TE Part Number
VG 95343 T09 C001 A	382A012-25-00-0	707290-000
VG 95343 T09 C002 A	382A023-25-00-0	879010-000
VG 95343 T09 C003 A	382A034-25-00-0	On application

TABLE COLOR KEY:

- System 25
- System 100
- System 200

VG 95343 Part 15 Adhesive



TE's Raychem S1125 epoxy adhesive is a thermoset (curing) two-part adhesive which is designed to provide environmental sealing and strain relief on wire and cable harnesses.

VG 95343 T15 D

VG Part Reference	TE Part Description	TE Part Number
VG 95343T15A001A	S1125-Kit-1	878462-000
VG95343T15A002B	S1125-Kit-8	657863-000

VG 95343 T15 D

VG Part Reference	TE Part Description	TE Part Number
VG 95343T15D002B	S1184-Kit-1	369276-000

VG 95343 T15 DA

VG Part Reference	TE Part Description	TE Part Number
VG95343T15DA	S1125-APPLICATOR	CL1665-001

VG 95343 T15 MA

VG Part Reference	TE Part Description	TE Part Number
VG95343T15MA	S1125-MIXER-NOZZLE	CH4909-000

TABLE COLOR KEY:

- System 25
- System 100
- System 200

VG 95343 Part 18 Molded Parts



TE's heat shrinkable molded boots in -25 elastomeric molding compound provide a tough, semi-rigid, fluid and temperature resistant interface between connector adaptor backshells and harness cabling. Designed to offer excellent performance in harsh environments, the /225 pre-coated VG qualified adhesive will seal and help protect from fluid and dust ingress. They are ideal for use in military vehicles where high temperatures and long exposure to fluids is expected.

202K121 to 185

As Supplied

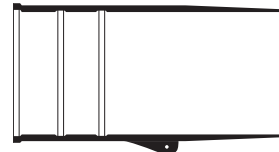

After Unrestricted Recovery

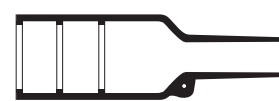

202D121 to 196

As Supplied

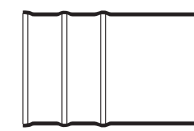

After Unrestricted Recovery



202D211 to 299

As Supplied



After Unrestricted Recovery



222K121 to 185

As Supplied

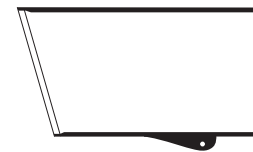

After Unrestricted Recovery



222D211 to 299

As Supplied

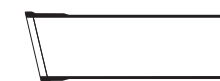

After Unrestricted Recovery

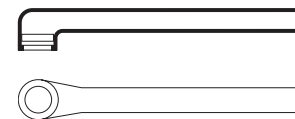

222D921 to 963

As Supplied



After Unrestricted Recovery

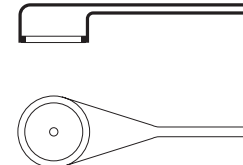

214A011 to 052

As Supplied

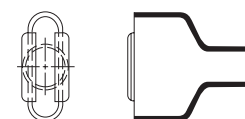

After Unrestricted Recovery

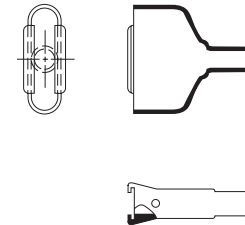

214A311 to 352

As Supplied

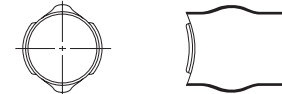

After Unrestricted Recovery

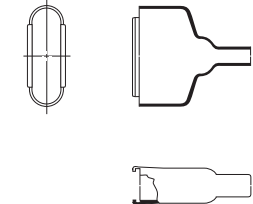

VG 95343 Part 18 Molded Parts



VG 95343 T18 A

VG Part Reference	TE Part Description	TE Part Number
VG 95343 T18 A001 A	202K121-25-01/225-0	042045-000
VG 95343 T18 A002 A	202K232-25-01/225-0	975754-000
VG 95343 T18 A003 A	202K132-25-01/225-0	259472-000
VG 95343 T18 A004 A	202K142-25-01/225-0	675477-000
VG 95343 T18 A005 A	202K153-25-01/225-0	305258-000
VG 95343 T18 A006 A	202K163-25-02/225-0	856164-000
VG 95343 T18 A007 A	202K174-25-02/225-0	491908-000
VG 95343 T18 A008 A	202K185-25-02/225-0	923376-000
VG 95343 T18 A010 A	203W112-25/225-0	143023-000
VG 95343 T18 A011 A	204W201-25/225-0	CP9851-000
VG 95343 T18 A012 A	202W112-25/225-0	CF7987-000
VG 95343 T18 A013 A	203W301-25-G02/225-0	CN2099-000
VG 95343 T18 A014 A	202K111-25-01/225-0	E61009-000
VG 95343 T18 A015 A	202K111-25/225-0	408452-000

VG 95343 T18 B

VG Part Reference	TE Part Description	TE Part Number
VG 95343 T18 B001 A	202K121-25/225-0	634051-000
VG 95343 T18 B002 A	202K232-25/225-0	433530-000
VG 95343 T18 B003 A	202K132-25/225-0	481350-000
VG 95343 T18 B004 A	202K142-25/225-0	864607-000
VG 95343 T18 B005 A	202K153-25/225-0	223494-000
VG 95343 T18 B006 A	202K163-25-01/225-0	358792-000
VG 95343 T18 B007 A	202K174-25-01/225-0	518286-000
VG 95343 T18 B008 A	202K185-25-01/225-0	861569-000

VG 95343 T18 C

VG Part Reference	TE Part Description	TE Part Number
VG 95343 T18 C001 A	202K163-25/225-0	566586-000
VG 95343 T18 C002 A	202K174-25/225-0	375458-000
VG 95343 T18 C003 A	202K185-25/225-0	297185-000

VG 95343 T18 D

VG Part Reference	TE Part Description	TE Part Number
VG 95343 T18 D001 A	222K121-25/225-0	117451-000
VG 95343 T18 D002 A	222K132-25/225-0	131250-000
VG 95343 T18 D003 A	222K142-25/225-0	892144-000
VG 95343 T18 D004 A	222K152-25/225-0	723486-000
VG 95343 T18 D005 A	222K163-25/225-0	903960-000
VG 95343 T18 D006 A	222K174-25/225-0	369242-000
VG 95343 T18 D007 A	222K185-25/225-0	881029-000

TABLE COLOR KEY:

- System 25
- System 100
- System 200

VG 95343 T18 E

VG Part Reference	TE Part Description	TE Part Number
VG 95343 T18 E001 A	214A011-25/225-0	714998-000
VG 95343 T18 E002 A	214A021-25/225-0	054832-000
VG 95343 T18 E003 A	214A032-25/225-0	587829-000
VG 95343 T18 E004 A	214A042-25/225-0	252797-000
VG 95343 T18 E005 A	214A052-25/225-0	336719-000
VG 95343 T18 E006 A	214A311-25/225-0	530062-000
VG 95343 T18 E007 A	214A321-25/225-0	on application
VG 95343 T18 E008 A	214A332-25/225-0	C87808-000
VG 95343 T18 E009 A	214A342-25/225-0	175855-000
VG 95343 T18 E010 A	214A352-25/225-0	EP3906-000
VG 95343 T18 E011 A	214A452-25/225-0	on application

VG 95343 T18 F

VG Part Reference	TE Part Description	TE Part Number
VG 95343 T18 F001 A	234A111-25/225-0	125561-000
VG 95343 T18 F002 A	234A121-25/225-0	304817-000
VG 95343 T18 F003 A	234A132-25/225-0	935479-000
VG 95343 T18 F004 A	234A142-25/225-0	086245-000
VG 95343 T18 F005 A	234A152-25/225-0	709189-000
VG 95343 T18 F006 A	234A711-25/225-0	on application
VG 95343 T18 F007 A	234A811-25/225-0	on application
VG 95343 T18 F008 A	234A721-25/225-0	on application
VG 95343 T18 F009 A	234A732-25/225-0	on application
VG 95343 T18 F010 A	234A742-25/225-0	on application
VG 95343 T18 F011 A	234A752-25/225-0	on application

VG 95343 T18 G

VG Part Reference	TE Part Description	TE Part Number
VG 95343 T18 G001 A	234A011-25/225-0	638829-000
VG 95343 T18 G002 A	234A061-25/225-0	on application
VG 95343 T18 G003 A	234A021-25/225-0	827125-000
VG 95343 T18 G004 A	234A071-25/225-0	on application
VG 95343 T18 G005 A	234A032-25/225-0	148313-000
VG 95343 T18 G006 A	234A042-25/225-0	074447-000
VG 95343 T18 G007 A	234A052-25/225-0	on application
VG 95343 T18 G008 A	234A611-25/225-0	A42642-000
VG 95343 T18 G009 A	234A661-25/225-0	on application
VG 95343 T18 G010 A	234A621-25/225-0	on application
VG 95343 T18 G011 A	234A671-25/225-0	on application
VG 95343 T18 G012 A	234A632-25/225-0	E50539-000
VG 95343 T18 G013 A	234A642-25/225-0	on application
VG 95343 T18 G014 A	234A652-25/225-0	C97710-000

VG 95343 T18 H

VG Part Reference	TE Part Description	TE Part Number
VG 95343 T18 H001 A	222D921-25-G05/225-0	009227-000
VG 95343 T18 H002 A	222D921-25-G06/225-0	443911-000

VG 95343 Part 19 Transition Molded Parts



TE's heat shrinkable transitions in -25 elastomeric molding compound provide tough, semi-rigid, fluid and temperature resistant cable and harness breakouts. Designed to offer excellent performance in harsh environments, the /225 pre-coat VG qualified adhesive will seal and help protect from fluid and dust ingress. They are ideal for use in military vehicles where high temperatures and long exposure to fluids is expected.

322A112 to 158

As Supplied



After Unrestricted Recovery

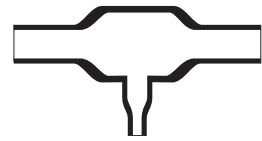

301A011 to 048

As Supplied

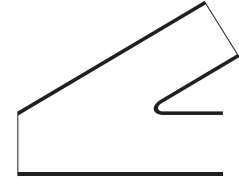

After Unrestricted Recovery

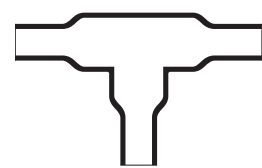

342A012 to 058

As Supplied



After Unrestricted Recovery



362A014 to 114

As Supplied

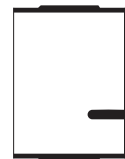

After Unrestricted Recovery



382A012 to 046

As Supplied

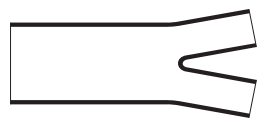

After Unrestricted Recovery



462A011 to 060

As Supplied



After Unrestricted Recovery

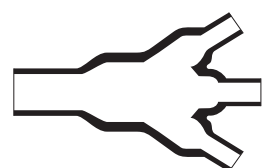

562A011 to 067

As Supplied

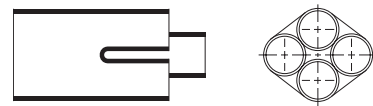

After Unrestricted Recovery

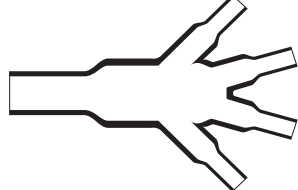

VG 95343 Part 19 Transition Molded Parts



VG 95343 T19 A

VG Part Reference	TE Part Description	TE Part Number
VG 95343 T19 A001 A	322A112-25/225-0	961725-000
VG 95343 T19 A002 A	322A134-25/225-0	305731-000
VG 95343 T19 A003 A	322A434-25/225-0	280291-000
VG 95343 T19 A004 A	322A123-25/225-0	475200-000
VG 95343 T19 A005 A	322A148-25/225-0	490061-000
VG 95343 T19 A006 A	322A158-25/225-0	489955-000
VG 95343 T19 A007 A	322A412-25/225-0	248477-000
VG 95343 T19 A008 A	322A423-25/225-0	570137-000
VG 95343 T19 A009 A	301A011-25/225-0	521393-000
VG 95343 T19 A010 A	301A022-25/225-0	164153-000
VG 95343 T19 A011 A	301A034-25/225-0	661273-000
VG 95343 T19 A012 A	301A048-25/225-0	473955-000
VG 95343 T19 A013 A	302A012-25/225-0	028997-000
VG 95343 T19 A014 A	302A024-25/225-0	364973-000
VG 95343 T19 A015 A	302A037-25/225-0	472071-000
VG 95343 T19 A016 A	322A012-25/225-0	339267-000
VG 95343 T19 A017 A	322A024-25/225-0	226149-000
VG 95343 T19 A018 A	322A037-25/225-0	874511-000

VG 95343 T19 B

VG Part Reference	TE Part Description	TE Part Number
VG 95343 T19 B001 A	342A012-25/225-0	153282-000
VG 95343 T19 B002 A	342A034-25/225-0	413669-000
VG 95343 T19 B003 A	362A014-25/225-0	604980-000
VG 95343 T19 B004 A	342A024-25/225-0	416486-000
VG 95343 T19 B005 A	342A048-25/225-0	027099-000
VG 95343 T19 B006 A	342A058-25/225-0	768473-000
VG 95343 T19 B007 A	362A024-25/225-0	236143-000
VG 95343 T19 B008 A	362A114-25/225-0	524205-000
VG 95343 T19 B009 A	341A015-25/225-0	511239-000
VG 95343 T19 B010 A	342A112-25/225-0	312711-000
VG 95343 T19 B011 A	342A124-25/225-0	149069-000
VG 95343 T19 B012 A	342A138-25/225-0	853575-000
VG 95343 T19 B013 A	342A012-25-G05/225-0	146873-000

TABLE COLOR KEY:

- System 25
- System 100
- System 200

VG 95343 T19 C

VG Part Reference	TE Part Description	TE Part Number
VG 95343 T19 C001 A	382A012-25/225-0	855366-000
VG 95343 T19 C002 A	382A023-25/225-0	971078-000
VG 95343 T19 C003 A	382A034-25/225-0	511608-000
VG 95343 T19 C004 A	382A046-25/225-0	152169-000
VG 95343 T19 C005 A	342A215-25/225-0	556951-000
VG 95343 T19 C006 A	382A012-25-G05/225-0	578453-000
VG 95343 T19 C007 A	382W042-25/225-0	831991-000

VG 95343 T19 D

VG Part Reference	TE Part Description	TE Part Number
VG 95343 T19 D001 A	462A011-25/225-0	299698-000
VG 95343 T19 D002 A	462A023-25/225-0	997172-000
VG 95343 T19 D003 A	462A034-25/225-0	637460-000
VG 95343 T19 D004 A	462A046-25/225-0	201443-000
VG 95343 T19 D005 A	462A011-25-G06/225-0	361705-000
VG 95343 T19 D006 A	462A011-25-G05/225-0	086959-000
VG 95343 T19 D007 A	462A023-25-G07/225-0	290469-000

VG 95343 T19 E

VG Part Reference	TE Part Description	TE Part Number
VG 95343 T19 E001 A	562A011-25/225-0	974867-000
VG 95343 T19 E002 A	562A022-25/225-0	351271-000
VG 95343 T19 E003 A	562A032-25/225-0	982918-000
VG 95343 T19 E004 A	562A043-25/225-0	416784-000
VG 95343 T19 E005 A	562A054-25/225-0	381707-000
VG 95343 T19 E006 A	562A032-25-G03/225-0	529643-000
VG 95343 T19 E007 A	562A011-25-G02/225-0	597899-000
VG 95343 T19 E009 A	562A067-25/225-0	210783-000

VG 95343 T19 F

VG Part Reference	TE Part Description	TE Part Number
VG 95343 T19 F001 A	422A616-25/225-0	318749-000

VG 95343 T19 G

VG Part Reference	TE Part Description	TE Part Number
VG 95343 T19 G001 A	422A011-25/225-0	On application
VG 95343 T19 G002 A	422A414-25/225-0	134151-000

VG 95343 Part 25 Feedthrough Molded Parts



TE's heat shrinkable feedthroughs in -25 elastomeric molding compound provide strain relief and abrasion protection for cables passing through equipment boxes or panels. The -25/225 molding material and pre-coat adhesive seal and help protect the underlying cables from fluid and dust ingress.

207W213 to 256

As Supplied

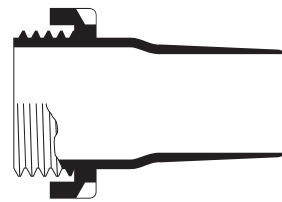

After Unrestricted Recovery

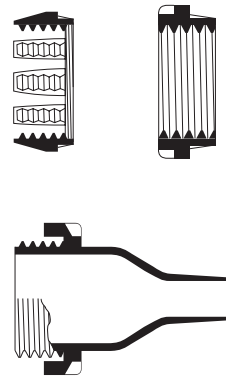

VG 95343 T25 A

VG Part Reference	TE Part Description	TE Part Number
VG 95343 T25 A001 A	207W213-25/225-0	401715-000
VG 95343 T25 A002 A	207W223-25/225-0	961701-000
VG 95343 T25 A003 A	207W234-25/225-0	240411-000
VG 95343 T25 A004 A	207W264-25/225-0	on application
VG 95343 T25 A005 A	207W256-25/225-0	688859-000
VG 95343 T25 A006 A	207W245-25/225-0	037765-000

VG 95343 T25 B

VG Part Reference	TE Part Description	TE Part Number
VG 95343 T25 B001 A	207W213-25-G01/225-0	on application
VG 95343 T25 B002 A	207W223-25-G01/225-0	037837-000
VG 95343 T25 B003 A	207W234-25-G01/225-0	405027-000
VG 95343 T25 B004 A	207W264-25-G01/225-0	on application
VG 95343 T25 B005 A	207W256-25-G01/225-0	on application
VG 95343 T25 B006 A	207W245-25-G01/225-0	on application

TABLE COLOR KEY:

- System 25
- System 100
- System 200

VG 95343 Part 28 Zerohal Molded Parts



TE's heat shrinkable transitions in -100 halogen free molding compound provide semi-flexible, low fire hazard protection and offer excellent fire safety characteristics with low smoke and low acid gas emission for cable and harness breakouts. Designed to offer good mechanical and fluid resistant properties particularly where hazard reduction in the event of fire is critical. With the pre-coat thermoplastic (hot melt)/86 VG qualified adhesive, these boots will seal and help protect from fluid and dust ingress. They are ideal for use in applications where there is the need to lower the risk of smoke and acid gas emission to people and equipment, for example for marine applications and mass transit systems.

322A112 to 158

As Supplied



After Unrestricted Recovery



301A011 to 048

As Supplied

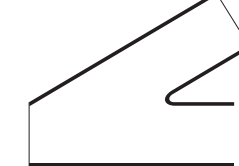

After Unrestricted Recovery

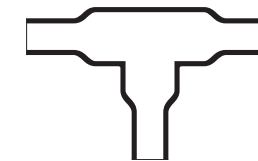

342A012 to 058

As Supplied



After Unrestricted Recovery



362A014 to 114

As Supplied



After Unrestricted Recovery



382A012 to 046

As Supplied



After Unrestricted Recovery



462A011 to 060

As Supplied



After Unrestricted Recovery

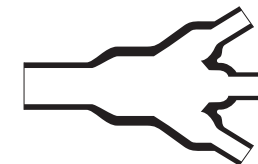

562A011 to 067

As Supplied

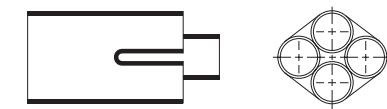

After Unrestricted Recovery

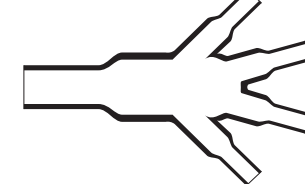

VG 95343 Part 28 Zerohal Molded Parts



VG 95343 T28 A

VG Part Reference	TE Part Description	TE Part Number
VG 95343 T28 A001A	202K121-100-01-0	791971-000
VG 95343 T28 A002A	202K232-100-01-0	on application
VG 95343 T28 A003A	202K132-100-01-0	401824-000
VG95343 T28 A004A	202K142-100-01-0	244520-000
VG 95343 T28 A005A	202K153-100-01-0	589952-000
VG 95343 T28 A006A	202K163-100-02-0	545801-000
VG 95343 T28 A007A	202K174-100-02-0	258775-000
VG 95343 T28 A008A	202K185-100-02-0	536143-000
VG 95343 T28A009A	202D196-100-10-0	on application
VG 95343 T28 A010A	204W201-100-0	on application
VG 95343 T28 A012A	203W301-100-G02-0	on application
VG 95343 T28 A013A	202K111-100-01-0	on application
VG 95343 T28 A014A	202K111-100-0	EG0027-000

VG 95343 T28 C

VG Part Reference	TE Part Description	TE Part Number
VG 95343 T28 C001A	202D163-100-0	074587-000
VG 95343 T28 C002A	202D174-100-0	645355-000
VG 95343 T28 C003A	202D185-100-0	182071-000
VG 95343 T28 C004A	202D196-100-0	078833-000

VG 95343 T28 D

VG Part Reference	TE Part Description	TE Part Number
VG 95343 T28 D001A	222D121-100-0	231619-000
VG 95343 T28 D002A	222D132-100-0	860805-000
VG 95343 T28 D003A	222D142-100-0	245829-000
VG 95343 T28 D004A	222D153-100-0	on application
VG 95343 T28 D005A	222D163-100-0	606517-000
VG 95343 T28 D006A	222D174-100-0	501797-000
VG 95343 T28 D007A	222D185-100-0	318679-000
VG 95343 T28 D008A	222D196-100-0	110773-000

VG 95343 T28 B

VG Part Reference	TE Part Description	TE Part Number
VG 95343 T28 B001A	202K121-100-0	720677-000
VG 95343 T28 B002A	202K232-100-0	185673-000
VG 95343 T28 B003A	202K132-100-0	312479-000
VG 95343 T28 B004A	202K142-100-0	041618-000
VG 95343 T28 B005A	202K153-100-0	339982-000
VG 95343 T28 B006A	202K163-100-01-0	313427-000
VG 95343 T28 B007A	202K174-100-01-0	952737-000
VG 95343 T28 B008A	202K185-100-01-0	344009-000
VG 95343 T28 B009A	202D196-100-08-0	on application

TABLE COLOR KEY:

 System 25
 System 100
 System 200

VG 95343 Part 29 Zerohal Molded Parts



TE's heat shrinkable molded boots in -100 halogen free molding compound provide semi-flexible, low fire hazard protection and offer excellent fire safety characteristics with low smoke and low acid gas emission for cable and harness breakouts. Designed to offer good strain relief and mechanical and fluid resistant properties particularly where hazard reduction in the event of fire is critical. With the pre-coat thermoplastic(hot melt) /86 VG qualified adhesive, these boots will seal and protect from fluid and dust ingress. They are ideal for use in applications where there is the need to lower the risk of smoke and acid gas emission to people and equipment, for example for marine applications and mass transit systems.

202K1**-100

As Supplied

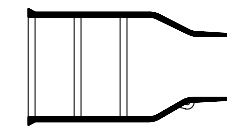

After Unrestricted Recovery

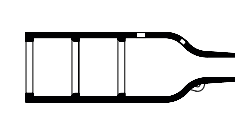

222K1**-100

As Supplied

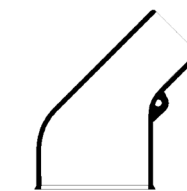

After Unrestricted Recovery

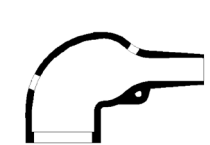

VG 95343 T29 A

VG Part Reference	TE Part Description	TE Part Number
VG 95343 T29 A001 A	202K121-100-01/86-0	709929-000
VG 95343 T29 A002 A	202K232-100-01/86-0	684513-000
VG 95343 T29 A003 A	202K132-100-01/86-0	346501-000
VG 95343 T29 A004 A	202K142-100-01/86-0	395481-000
VG 95343 T29 A005 A	202K153-100-01/86-0	307317-000
VG 95343 T29 A006 A	202K163-100-02/86-0	507989-000
VG 95343 T29 A007 A	202K174-100-02/86-0	300347-000
VG 95343 T29 A008 A	202K185-100-02/86-0	881797-000
VG 95343 T29 A009 A	202D196-100-10/86-0	357197-000

VG 95343 T29 C

VG Part Reference	TE Part Description	TE Part Number
VG 95343 T29 C001 A	202K163-100/86-0	828431-000
VG 95343 T29 C002 A	202K174-100/86-0	027627-000
VG 95343 T29 C003 A	202K185-100/86-0	456073-000
VG 95343 T29 C004 A	202D196-100/86-0	597575-000

VG 95343 T29 B

VG Part Reference	TE Part Description	TE Part Number
VG 95343 T29 B001 A	202K121-100/86-0	357197-000
VG 95343 T29 B002 A	202K232-100/86-0	434149-000
VG 95343 T29 B003 A	202K132-100/86-0	764503-000
VG 95343 T29 B004 A	202K142-100/86-0	539835-000
VG 95343 T29 B005 A	202K153-100/86-0	509961-000
VG 95343 T29 B006 A	202K163-100-01/86-0	979127-000
VG 95343 T29 B007 A	202K174-100-01/86-0	799567-000
VG 95343 T29 B008 A	202K185-100-01/86-0	768115-000

VG 95343 T29 D

VG Part Reference	TE Part Description	TE Part Number
VG 95343 T29 D001 A	222K121-100/86-0	018671-000
VG 95343 T29 D002 A	222K132-100/86-0	626617-000
VG 95343 T29 D003 A	222K142-100/86-0	797795-000
VG 95343 T29 D004 A	222K152-100/86-0	043115-000
VG 95343 T29 D005 A	222K163-100/86-0	859089-000
VG 95343 T29 D006 A	222K174-100/86-0	610643-000
VG 95343 T29 D007 A	222K185-100/86-0	929945-000
VG 95343 T29 D008 A	222D196-100/86-0	337325-000

TABLE COLOR KEY:

 System 25
 System 100
 System 200

VG 95343 Part 30 Zerohal Transition Molded Parts



TE's heat shrinkable transitions in -100 halogen free molding compound provide semi-flexible, low fire hazard protection and offer excellent fire safety characteristics with low smoke and low acid gas emission for cable and harness breakouts. Designed to offer good mechanical and fluid resistant properties particularly where hazard reduction in the event of fire is critical. With the pre-coat thermoplastic(hot melt) /86 VG qualified adhesive, these boots will seal and help protect from fluid and dust ingress. They are ideal for use in applications where there is the need to lower the risk of smoke and acid gas emission to people and equipment, for example for marine applications and mass transit systems.

322A112 to 158

As Supplied



After Unrestricted Recovery

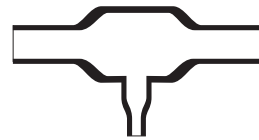

301A011 to 048

As Supplied

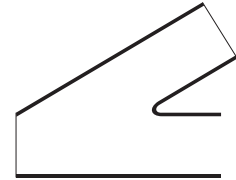

After Unrestricted Recovery

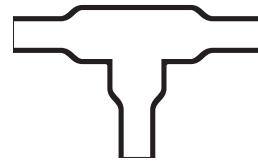

342A012 to 058

As Supplied



After Unrestricted Recovery



362A014 to 114

As Supplied



After Unrestricted Recovery



382A012 to 046

As Supplied

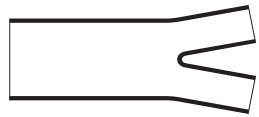

After Unrestricted Recovery



462A011 to 060

As Supplied



After Unrestricted Recovery

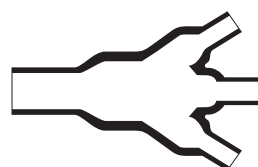

562A011 to 067

As Supplied

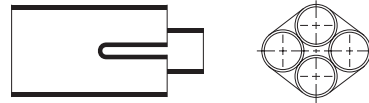

After Unrestricted Recovery

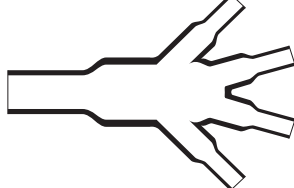

VG 95343 Part 30 Zerohal Transition Molded Parts



VG 95343 T30 A

VG Part Reference	TE Part Description	TE Part Number
VG 95343 T30 A001 A	322A112-100/86-0	838205-000
VG 95343 T30 A002 A	322A134-100/86-0	762909-000
VG 95343 T30 A003 A	322A434-100/86-0	CV0048-000
VG 95343 T30 A004 A	322A123-100/86-0	535359-000
VG 95343 T30 A005 A	322A148-100/86-0	279519-000
VG 95343 T30 A006 A	322A158-100/86-0	CC1466-000
VG 95343 T30 A007 A	322A412-100/86-0	D90490-000
VG 95343 T30 A008 A	322A423-100/86-0	on application
VG 95343 T30 A009 A	301A011-100/86-0	237411-000
VG 95343 T30 A010 A	301A022-100/86-0	815501-000
VG 95343 T30 A011 A	301A034-100/86-0	326051-000
VG 95343 T30 A012 A	301A048-100/86-0	EP8807-000
VG 95343 T30 A013 A	302A012-100/86-0	CS1135-000
VG 95343 T30 A014 A	302A024-100/86-0	492467-000
VG 95343 T30 A015 A	302A037-100/86-0	EM3466-000
VG 95343 T30 A016 A	322A012-100/86-0	953217-000
VG 95343 T30 A017 A	322A024-100/86-0	CN1137-000
VG 95343 T30 A018 A	322A037-100/86-0	on application

VG 95343 T30 B

VG Part Reference	TE Part Description	TE Part Number
VG 95343 T30 B001 A	342A012-100/86-0	480093-000
VG 95343 T30 B002 A	342A034-100/86-0	248005-000
VG 95343 T30 B003 A	362A014-100/86-0	197577-000
VG 95343 T30 B004 A	342A024-100/86-0	859701-000
VG 95343 T30 B005 A	342A048-100/86-0	on application
VG 95343 T30 B006 A	342A058-100/86-0	on application
VG 95343 T30 B007 A	362A024-100/86-0	CA4279-000
VG 95343 T30 B008 A	362A114-100/86-0	CR7539-000
VG 95343 T30 B009 A	341A015-100/86-0	CC2034-000
VG 95343 T30 B010 A	342A112-100/86-0	312867-000
VG 95343 T30 B011 A	342A124-100/86-0	556207-000
VG 95343 T30 B012 A	342A138-100/86-0	on application
VG 95343 T30 B013 A	342A012-100-G05/86-0	E75778-000

TABLE COLOR KEY:

System 25
System 100
System 200

VG 95343 T30 C

VG Part Reference	TE Part Description	TE Part Number
VG 95343 T30 C001 A	382A012-100/86-0	604791-000
VG 95343 T30 C002 A	382A023-100/86-0	256823-000
VG 95343 T30 C003 A	382A034-100/86-0	245099-000
VG 95343 T30 C004 A	382A046-100/86-0	072969-000
VG 95343 T30 C005 A	342A215-100/86-0	CC2792-000
VG 95343 T30 C006 A	382A012-100-G05/86-0	F20649-000
VG 95343 T30 C007 A	382W042-100/86-0	CM4173-000

VG 95343 T30 D

VG Part Reference	TE Part Description	TE Part Number
VG 95343 T30 D001 A	462A011-100/86-0	020631-000
VG 95343 T30 D002 A	462A023-100/86-0	292395-000
VG 95343 T30 D003 A	462A034-100/86-0	457717-000
VG 95343 T30 D004 A	462A046-100/86-0	CC2830-000
VG 95343 T30 D005 A	462A011-100-G06/86-0	on application
VG 95343 T30 D006 A	462A011-100-G05/86-0	432368-000
VG 95343 T30 D007 A	462A023-100-G07/86-0	E00820-000

T05

T06

T07

T08

T09

T15

T18

T19

T25

T28

T29

T30

T05

T06

T07

T08

T09

T15

T18

T19

T25

T28

T29

T30

VG 96936 T10 Raybraid EMI Shielding Braid Ray 101 and Ray 90

T10

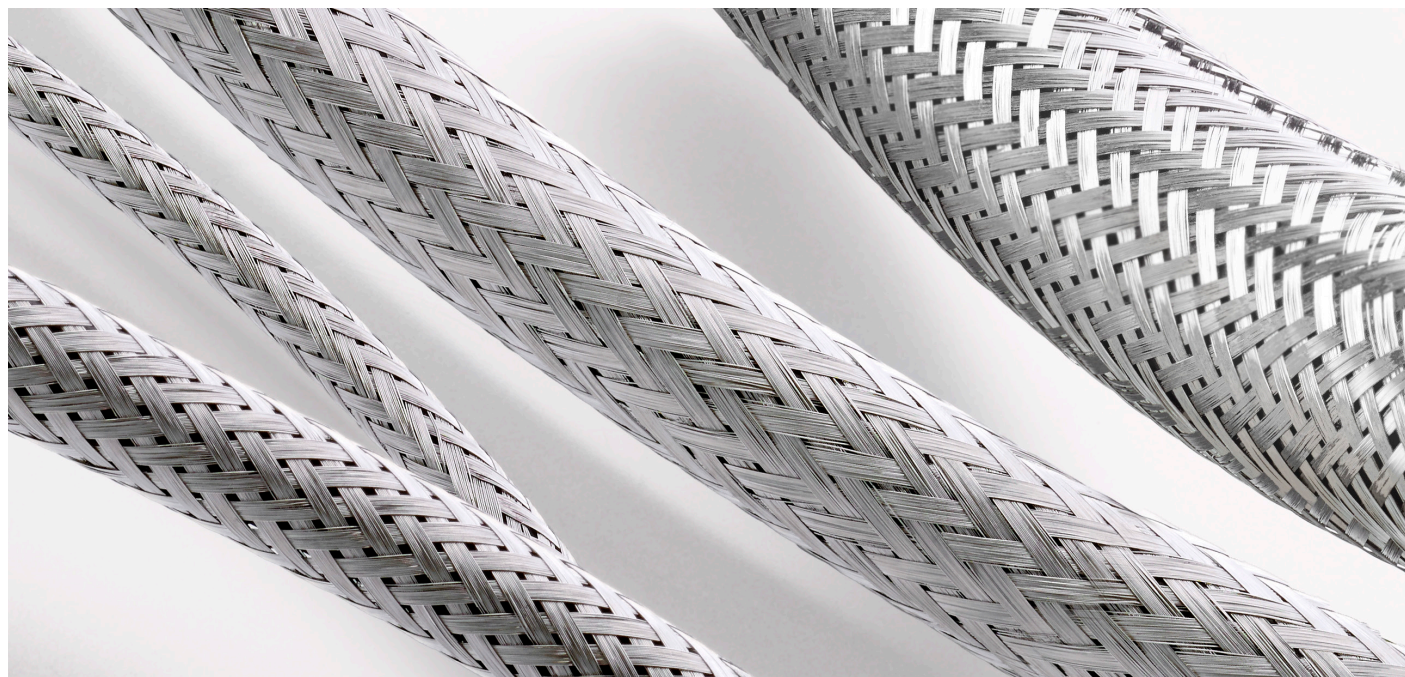

The Raybraid circular, flexible tin-plated copper braiding is VG qualified for the electrical screening of wire bundles. RAY 90 gives a minimum of 90% optical coverage. RAY 101 gives a minimum of 93% optical coverage and up to a maximum of 100% optical coverage. It is more flexible than RAY 90, with a minimum 2:1 expansion ratio.



VG 96936 T10 A

VG Part Reference	TE Part Description	TE Part Number
VG 96936 T10 A001 A	RAY-101-3.0(100)	F345203001
VG 96936 T10 A002 A	RAY-101-4.0(100)	D561523001
VG 96936 T10 A003 A	RAY-101-6.0(100)	A513413001
VG 96936 T10 A004 A	RAY-101-7.5	A165103001
VG 96936 T10 A005 A	RAY-101-10.0(100)	D761993001
VG 96936 T10 A006 A	RAY-101-12.5	C538733001
VG 96936 T10 A007 A	RAY-101-20.0	005901-000

VG 96936 T10 B

VG Part Reference	TE Part Description	TE Part Number
VG 96936 T10 B001 A	RAY-90-3.0(100)	C864813001
VG 96936 T10 B002 A	RAY-90-4.0(100)	F766883001
VG 96936 T10 B003 A	RAY-90-5.0(100)	C351013001
VG 96936 T10 B004 A	RAY-90-6.0(100)	C612383001
VG 96936 T10 B005 A	RAY-90-10.0(100)	F670223001
VG 96936 T10 B006 A	RAY-90-12.5(100)	A427053001
VG 96936 T10 B007 A	RAY-90-15.0(100)	2908663005
VG 96936 T10 B008 A	RAY-90-20.0(50)	2H00143003
VG 96936 T10 B009 A	RAY-90-25.0(50)	2H00153003
VG 96936 T10 B010 A	RAY-90-30.0(50)	2908733004

VG 95236 T13 Heat Guns and Reflectors

T13



TE offers a variety of dependable hand and bench-mount tools for crimping Raychem devices and heating heat-shrinkable products. The tools help give you accuracy in terminations— increasing productivity, reducing rework, and taking the guesswork out of procedures. With easy-to-use controls and ergonomic design, Raychem tools help make the job go faster and easier.

HIGH QUALITY

- Manufactured to TE's strict quality standards
- Tools are designed to make every job easy and trouble-free
- Made from the highest quality materials for low cost of ownership

EASY TO USE

- Designed and developed with the operator in mind
- Convenient, easy to use features make installations faster and easier
- Broad choice in tooling, from simple hand tools to advanced, automatic operation



VG Part Reference	TE Part Description	TE Part No.	Federal Stock No.
VG 95236 T13 AA001	PR-51-REFLECTOR	113069-000	4940-12-358-8081
VG 95236 T13 AA002	PR-26-REFLECTOR	991967-000	4940-12-186-7770
VG 95236 T13 AB001	PR-25-REFLECTOR	991965-000	4940-12-181-2462
VG 95236 T13 AB002	PR-25-D-REFLECTOR	989523-000	4940-12-186-7769
VG 95236 T13 AB003	PR-13-REFLECTOR	991963-000	4940-12-186-7766
VG 95236 T13 AB004	PR-12 -REFLECTOR	991973-000	4940-12-159-5432
VG 95236 T13 AB005	PR-21-REFLECTOR	991984-000	4940-12-186-7768
VG 95236 T13 AB006	PR-13-C-REFLECTOR	991974-000	4940-12-186-7767
VG 95236 T13 AB007	PR-24-REFLECTOR	991964-000	4940-12-159-5433
VG 95236 T13 AB008	PR-33-REFLECTOR	997768-000	4940-12-311-3324
VG 95236 T13 D0001	CV1981-ST-230V1600W-EU	EG1114-000	4940-12-402-6873
VG 95236 T13 F0001	CV1981-ATPID-230V1600W-EU	EG1106-000	4940-12-402-6871

VG 96933 T105 Crimp Splices

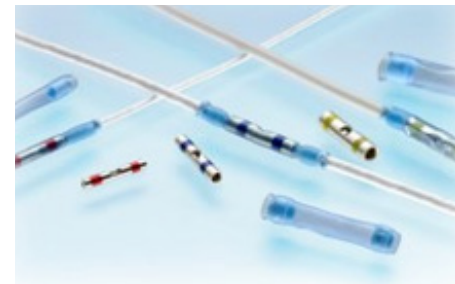

MiniSeal wire-to-wire splicing products offer solutions for hundreds of aerospace and defense applications. These environment resistant splices provide excellent reliability, long term performance, MIL-S-81824/1 qualification, and a low installed cost.

MiniSeal crimp splices consist of a plated copper crimp barrel and a separate, heat-shrinkable, transparent sealing sleeve. MiniSeal splices are one of the smallest, lightest, and most environment-resistant splices available. They preserve the electrical integrity of the splice by preventing the penetration of liquids and the resulting chemical and galvanic corrosion.

RUGGED

- Insulation and strain relief
- Immersion-resistant crimp splices are on QPL for SAE-AS81824

CAPABLE

- MIL-Spec approval
- Small size
- Light weight

EASY TO USE

- Easy installation

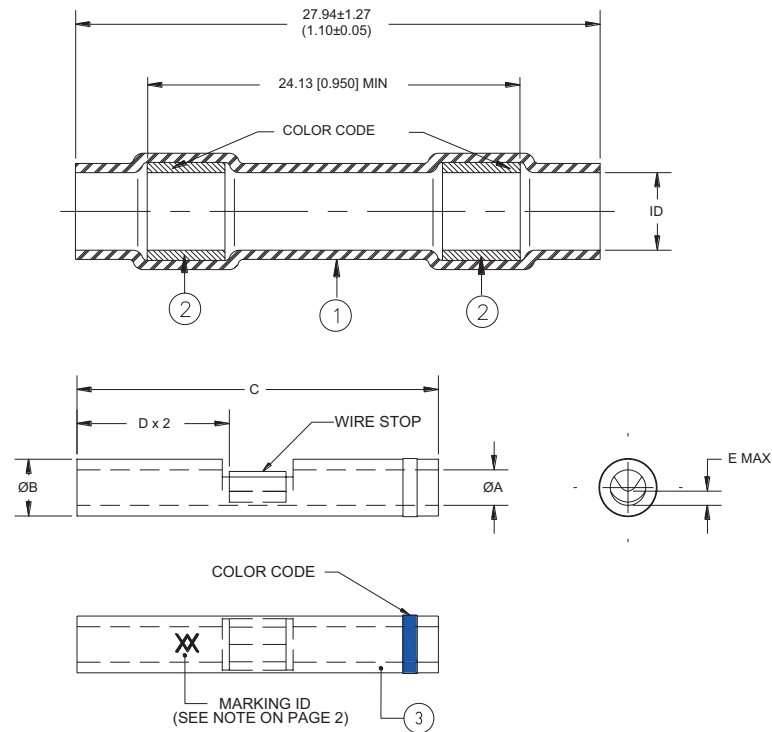

VG Part Reference	TE Part Description	TE Part No.	MIL Qual. No.	Federal Stock No.	Dimension Details						Color Code
					I.D.* a (min) b (max)	ØA	ØB	C	D	E max	
VG 96933 T105	D-436-36	650074-000	M81824/1-1	5940-00-266-8424	2.16 (0.085)	1.27 (0.050)	2.03 (0.080)	12.95 (0.510)	6.22 (0.245)	0.38 (0.015)	Red
					0.64 (0.025)	1.14 (0.045)	1.91 (0.075)	12.45 (0.490)	5.72 (0.225)		
VG 96933 T105	D-436-37	650075-000	M81824/1-2	5940-00-271-7741	2.79 (0.110)	1.75 (0.069)	2.70 (0.106)	14.86 (0.585)	7.11 (0.280)	0.51 (0.020)	Blue
					0.64 (0.025)	1.63 (0.064)	2.57 (0.101)	14.35 (0.565)	6.60 (0.260)		
VG 96933 T105	D-436-38	650076-000	M81824/1-3	5940-00-266-8425	4.32 (0.170)	2.60 (0.102)	3.89 (0.153)	14.86 (0.585)	7.11 (0.280)	1.27 (0.050)	Yellow
					0.64 (0.025)	2.46 (0.097)	3.73 (0.147)	14.35 (0.565)	6.60 (0.260)		

- NOTES:
- * I.D.: a- As received; b- After unrestricted recovery thru meltable insert.
 - Crimping tool - AD-1377-CRIMP-TOOL-3-CVTY (992008-000).

VG 95319 T10 Shielded One-Piece Solder Contacts



One-piece controlled-reflow-solder SolderTacts contacts are designed to terminate coaxial cables, shielded wires and twisted pairs faster and more reliably than other methods. SolderTacts contacts help eliminate the variables of crimping.

The one-step installation process helps cut down on production time while reducing handling and installed costs. These contacts contain two SolderSleeve terminations. One terminator connects the cable's signal conductor to the contact's inner pin. The other terminator connects the shield or ground lead to the contact body. When the contact is heated, the solder melts to help provide a precise solder connection. SolderTacts contacts provide a simultaneous electrical connection and strain relief. Heat shrinkable tubing insulations help eliminate stress concentration on the wire within the contact.

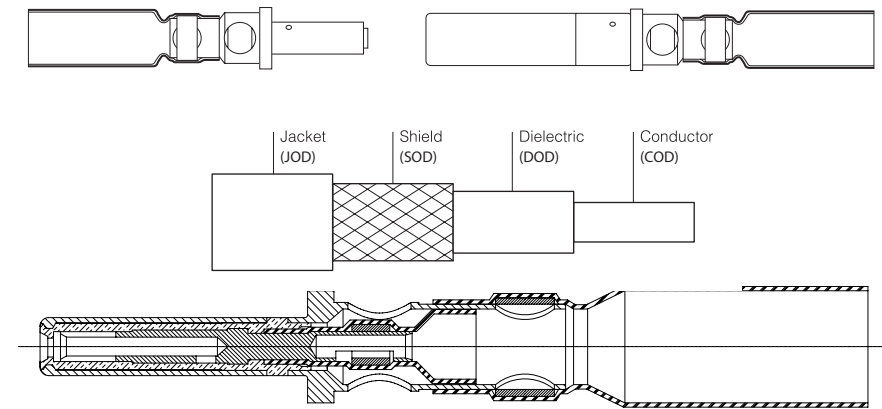

ECONOMICAL

- One-piece contact design with integrated soldering technology
- One-step installation process
- One contact fits multiple cable sizes
- No special tools required

RELIABLE

- 360° shielding reduces crosstalk and improves signal transmission
- Reflow solder joints are strong and reliable
- Controlled reflow soldering process yields reliable, consistent terminations
- Terminations are fully inspectable

VERSATILE

- Compatible with a variety of commercial and military connectors
- Termination available for coax cables, shielded pairs, twisted pairs, and triaxial cables
- 150°C temperature rating

VG Part Reference	TE Part Description	TE Part No.	MIL Qual. No.	Federal Stock No.	For Connectors	Cable Accommodated (1)	Contact Cavity Size	Type	Class
VG 95319-T1009P12	D-602-0150	865421-000	M39029/28	NA	MIL-C-38999	Raychem 5022A1X*X Raychem 9528A1X*X Raychem 9528D1X*X	12	D	A
VG 95319-T1009P16	D-602-0140	753454-000	M39029/76	5999-12-377-5156	MIL-C-38999	RG178 (2), RG179, RG316 Raychem 5026A1X*X Raychem 5026D1X*X Raychem 5028A1X*X Raychem 5030A1X*X Raychem 7528A1X*X Raychem 7530A1X*X	16	D	A
VG 95319-T1009P8	D-602-0122	521680-000	M39029/60	5999-12-377-5155	MIL-C-38999	RG58, RG180 Raychem 5022A1X1X Raychem 7522A1X1X Raychem 7524A1X1X	8	Copper Alloy Shielded	125°C
VG 95319-T1009S12	D-602-0151	899477-000	M39029/75	NA	MIL-C-38999	Raychem 5022A1X*X Raychem 9528A1X*X Raychem 9528D1X*X	12	D	A
VG 95319-T1009S16	D-602-0141	119468-000	M39029/77	5999-12-377-5154	MIL-C-38999	RG178 (2), RG179, RG316 Raychem 5026A1X*X Raychem 5026D1X*X Raychem 5028A1X*X Raychem 5030A1X*X Raychem 7528A1X*X Raychem 7530A1X*X	16	D	A

- NOTES:
- (1) Other Applications using Different Cables may be accommodated. Consult Manufacturer for details.

Introduction



VG 95319 connectors are some of the most popular and widely used circular connectors for ground defense or marine applications. With triple threads coupling, nine shell sizes, and a wide variety of contact arrangements, the connectors help give you the range of choices you need.

VG 95319-Style Connectors

TE helps meet the need for reliable performance with rugged VG 95319 connectors having 500 - 1,500 mating cycles, operating temperatures to 200°C, corrosion-resistant and corrosion-proof connector versions, scoop-proof designs, and a variety of options for excellent electromagnetic interference (EMI) control, such as filtering and fiber optics.

DTS Series: Lightweight aluminum shells for environmentally sealed version.

DTS-K and DTS-S Series: Stainless steel shells meeting the requirements of Classes K and S, suitable for firewall and high-temperature applications such as engines.

ACT Series: Composite shells, offering the lightest weight and highest resistance to corrosion.

Designed to Perform

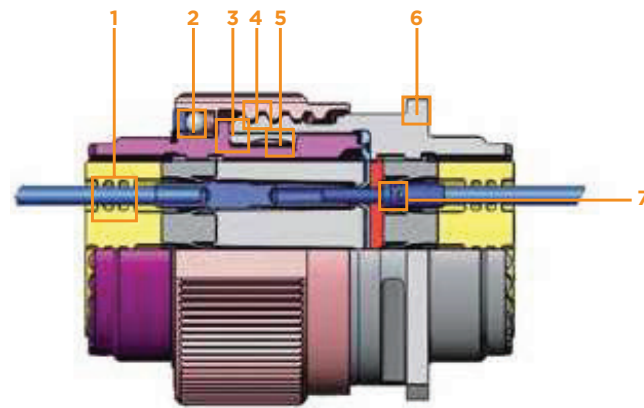

- 1 High-quality silicone seals to help maximize tear resistance and sealing memory
- 2 Self-locking threaded coupling
- 3 100% metal-to-metal bottoming for excellent EMI grounding protection
- 4 Triple-start threads
- 5 Grounding fingers providing excellent EMI protection
- 6 Elongated mounting holes for flexible mounting with standard MIL-DTL-38999 box or wall mount receptacles
- 7 Contact retention system provides excellent contact retention under severe vibration

HIGH PERFORMANCE

- -65°C to +200°C temperature range
- 500 - 1,500 mating cycles
- Over 50 contact arrangements available

RELIABLE

- Self-locking threaded coupling
- Robust ACME threads help decrease chance of damage
- 100% scoop proof
- Contact retention system provides excellent contact retention under severe vibration

EMI PROTECTED

- Grounding fingers for excellent EMI protection
- Connector is grounded when the shells meet, even before the contacts are engaged
- Trapezoidal thread for excellent shell-to-shell continuity

LIGHTWEIGHT COMPOSITE

- Up to 40% lighter than aluminum
- Up to 70% lighter than stainless steel
- Corrosion resistant - withstands up to 2,000 hours of salt spray

VG 95319 Connectors with DEUTSCH DTS and ACT Series Connectors Cross-Reference

Part Numbering VG 95319, DEUTSCH DTS and ACT Series Connectors

Commercial Composite	Commercial Aluminum/ Stainless	VG Spec	Description
RANGE	ACT	DTS	VG 95319
STYLE	20	20	1006 Square Flange Receptacle
	24	20	1007 Jam Nut Receptacle
	26	26	1008 Straight Plug
CLASS			
ALUMINUM SHELL			
--	F	F	Electroless Nickel Plated (48-hr. Salt Spray)
--	B	B	Aluminum-Bronze Alloy (1000-hr. Salt Spray)
--	W	W	Olive Drab Cadmium (500-hr. Salt Spray)
--	Z	Z	Black Zinc Nickel (500-hr. Salt Spray)
COMPOSITE SHELL			
M	--	M	Electroless Nickel Plated (2000-hr. Salt Spray)
J	--	J	Olive Drab Cadmium (2000-hr. Salt Spray)
STAINLESS STEEL SHELL			
--	K	K	Passivated S.S., Firewall (500-hr. Salt Spray)
--	S	S	Electrodeposited Nickel S.S., Firewall (500-hr. Salt Spray)
SHELL SIZES			
9 (A), 11 (B), 13 (C), 15 (C), 15 (D), 17 (E), 19 (F), 21 (G), 23 (H), 25 (J)			Numbers = DTS Commercial (Letters) = ACT Commercial
INSERT ARRANGEMENTS See Insert Arrangement Tables, pages 112-113			
CONTACTS			
P Pin	H 1500-Cycle Pin		
S Socket	J 1500-Cycle Socket		
A Less Pin (with intent to use nonstandard contacts)			
B Less Socket (with intent to use nonstandard contacts)			
KEYING			
N, A, B, C, D, E, U			N = Normal, U = Universal

For more details, please contact your TE representative.

DEUTSCH DTS and ACT Series Connectors

Insert		Contact Size/Quantity													Includes K Class	Uses 38999/62-8* Boots	Inactive: Superseded by
DTS Commercial	ACT Commercial	8 Twinax	8 Coax	8 Power	12 Twinax	12 Coax	10	12	16	20	22D	23	23				
09-07	A7 (A07)										7						
09-35	A35										6		✓				
09-98	A98									3			✓				
11-02	B2 (B02)								2								
11-04	B4 (B04)									4							
11-05	B5 (B05)									5							
11-35	B35										13		✓				
11-98	B98									6			✓				
11-99	B99									7			✓				
13-04	C4 (C04)								4								
13-08	C8 (COB)									8			✓				
13-35	C35										22		✓				
13-98	C98									10			✓				
15-05	D5 (D05)								5				✓				
15-15	D15							1	14								
15-18	D18									18			✓				
15-19	D19									19			✓				
15-26	D26								2		24						
15-35	D35										37		✓				
15-97	D97								4	8			✓				
17-02	E2 (E02)	1									38						17-03
17-03	E3 (E03)	1									38			✓			
17-06	E6 (E06)							6					✓				
17-08	E8 (E0B)								8				✓				
17-11	E11				2	1				8							
17-19	E19								4	11	4						
17-20	E20								4		16						
17-22	E22	2							2								
17-24	E24			2							22						
17-26	E26									26			✓				
17-35	E35										55		✓				
17-99	E99								2	21			✓				
19-11	F11									11			✓				
19-18	F18	4									14						19-19
19-19	F19	4									14			✓			
19-28	F28								2	26							

DEUTSCH DTS and ACT Series Connectors

Insert		Contact Size/Quantity													Includes K Class	Uses 38999/62-8* Boots	Inactive: Superseded by
DTS Commercial	ACT Commercial	8 Twinax	8 Coax	8 Power	12 Twinax	12 Coax	10	12	16	20	22D	23	23				
19-32	F32										32			✓			
19-35	F35										66			✓			
21-11	G11									11							
21-16	G16									16							
21-20	G20	2									18						
21-35	G35										79			✓			
21-39	G39									2	37			✓			
21-41	G41										41			✓			
21-48	G48			4													
21-75	G75	4															21-76
21-76	G76	4															
23-06	H6 (H06)	6															✓
23-21	H21									21							
23-35	H35										100						
23-53	H53										53			✓			
23-54	H54									4	9	40					
23-55	H55										55						
23-63	H63									4	4	49					
25-04	J4 (J04)										8	48			✓		
25-07	J7 (J07)	2										97					25-09
25-08	J8 (J08)	8															25-10
25-09	J9 (J09)	2										97				✓	
25-10	J10	8														✓	
25-11	J11									9		2					
25-17	J17	6										36					
25-19	J19										19						
25-20	J20	3									4	13	10				25-21
25-21	J21	3									4	13	10			✓	
25-24	J24											12	12				
25-29	J29											29					
25-35	J35											128					
25-37	J37											37					
25-43	J43											20	23				
25-46	J46			2								4	40				25-47
25-47	J47			2								4	40				
25-61	J61												61		✓		
25-90	J90	2										4	40				25-91
25-91	J91	2										4	40				✓

DEUTSCH DTS and ACT Series Connectors

DEUTSCH Square Flange Receptacle - Type 20

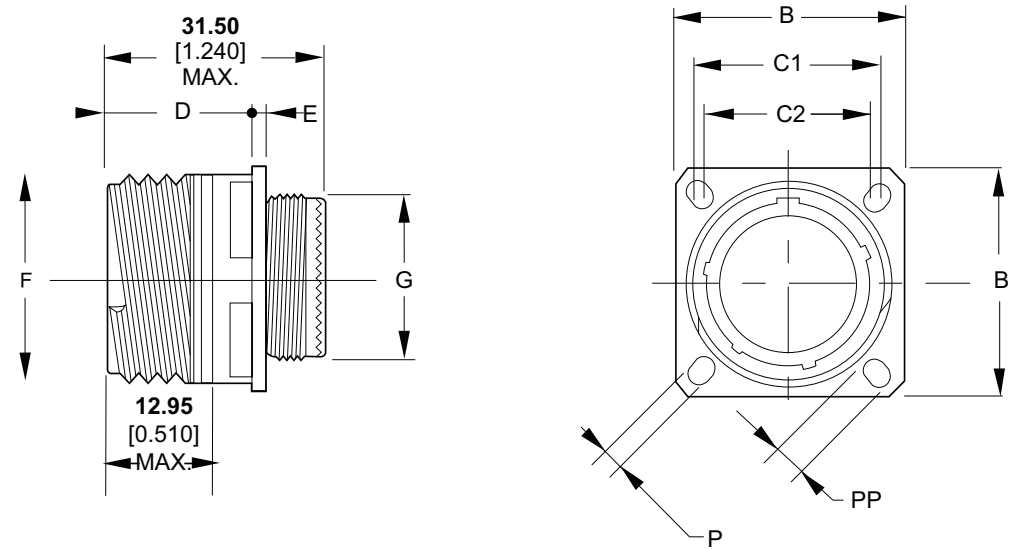

SHELL	B mm (in)	C1 mm (in)	C2 mm (in)	D MAX. mm (in)	E MAX. mm (in)	F mm (in)	G mm (in)	P mm (in)	PP mm (in)	MASS(g) BY SHELL TYPE		
										Al	SS	COMPOSITE
09	23.80 (0.937)	18.26 (0.719)	15.09 (0.594)	20.90 (0.823)	2.50 (0.098)	15.75 (0.620)	11.90 (0.469)	3.25 (0.128)	5.49 (0.216)	10	27	9
11	26.20 (1.031)	20.62 (0.812)	18.26 (0.719)	20.90 (0.823)	2.50 (0.098)	18.90 (0.744)	14.90 (0.587)	3.25 (0.128)	4.93 (0.194)	16	36	11
13	28.60 (1.126)	23.01 (0.906)	20.62 (0.812)	20.90 (0.823)	2.50 (0.098)	22.10 (0.870)	17.90 (0.705)	3.25 (0.128)	4.93 (0.194)	19	45	14
15	31.00 (1.220)	24.61 (0.969)	23.01 (0.906)	20.90 (0.823)	2.50 (0.098)	25.25 (0.994)	21.90 (0.862)	3.25 (0.128)	4.93 (0.194)	25	56	18
17	33.30 (1.311)	26.97 (1.062)	24.61 (0.969)	20.90 (0.823)	2.50 (0.098)	29.95 (1.179)	24.90 (0.980)	3.25 (0.128)	4.93 (0.194)	32	74	23
19	36.50 (1.437)	29.36 (1.156)	26.97 (1.062)	20.90 (0.823)	2.50 (0.098)	31.55 (1.242)	27.90 (1.098)	3.25 (0.128)	4.93 (0.194)	39	78	26
21	39.70 (1.563)	31.75 (1.250)	29.36 (1.156)	20.10 (0.791)	3.20 (0.126)	34.70 (1.366)	30.90 (1.217)	3.25 (0.128)	4.93 (0.194)	45	95	31
23	42.90 (1.689)	34.93 (1.375)	31.75 (1.250)	20.10 (0.791)	3.20 (0.126)	37.90 (1.492)	33.90 (1.335)	3.91 (0.154)	6.15 (0.242)	54	108	36
25	46.00 (1.811)	38.10 (1.500)	34.93 (1.375)	20.10 (0.791)	3.20 (0.126)	41.10 (1.618)	36.90 (1.453)	3.91 (0.154)	6.15 (0.242)	59	120	43

DEUTSCH DTS and ACT Series Connectors

DEUTSCH Jam Nut Receptacle - Type 24

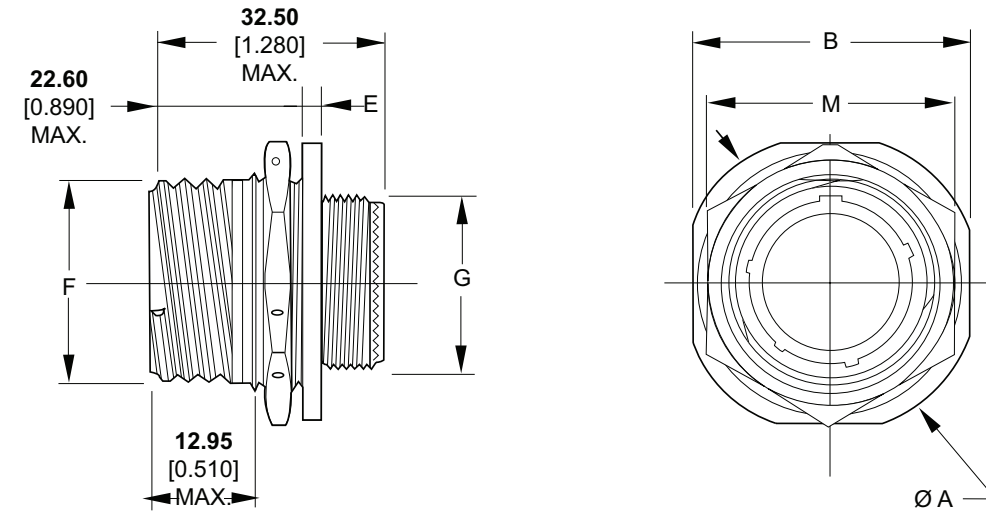

SHELL	A mm (in)	B mm (in)	E mm (in)	F mm (in)	G mm (in)	M MAX. mm (in)	MASS(g) BY SHELL TYPE		
							Al	SS	COMPOSITE
09	30.2 (1.189)	27.00 (1.063)	2.20 (0.087)	15.75 (0.620)	11.90 (0.469)	24.00 (0.945)	15	40	11
11	34.9 (1.374)	31.80 (1.252)	2.20 (0.087)	18.90 (0.744)	14.90 (0.587)	27.00 (1.063)	21	50	14
13	38.1 (1.500)	34.90 (1.374)	2.20 (0.087)	22.10 (0.870)	17.90 (0.705)	32.00 (1.260)	27	60	18
15	41.3 (1.626)	38.10 (1.500)	2.20 (0.087)	25.25 (0.994)	21.90 (0.862)	36.00 (1.417)	32	72	23
17	44.5 (1.752)	41.30 (1.626)	2.20 (0.087)	29.95 (1.179)	24.90 (0.980)	37.00 (1.457)	40	92	29
19	49.2 (1.937)	46.00 (1.811)	3.00 (0.118)	31.55 (1.242)	27.90 (1.098)	41.00 (1.614)	49	96	35
21	52.4 (2.063)	49.20 (1.937)	3.00 (0.118)	34.70 (1.366)	30.90 (1.217)	46.00 (1.811)	54	114	38
23	55.6 (2.189)	52.40 (2.063)	3.00 (0.118)	37.90 (1.492)	33.90 (1.335)	50.00 (1.969)	65	130	46
25	58.7 (2.311)	55.60 (2.189)	3.00 (0.118)	41.10 (1.618)	36.90 (1.453)	51.23 (2.017)	73	143	55

DEUTSCH DTS and ACT Series Connectors

DEUTSCH Plug - Type 26

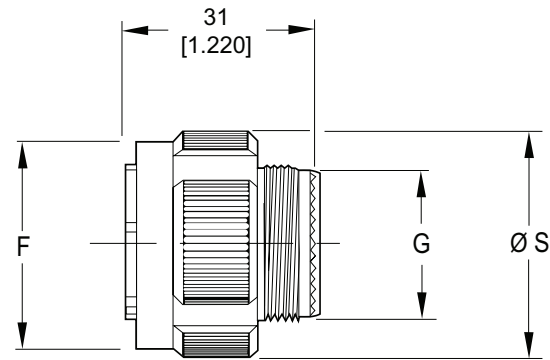

SHELL SIZE	B mm (in)	C1 mm (in)	C2 mm (in)	MASS(g) BY SHELL TYPE			COUPLING TORQUE: PLUG TO RECEPTACLE			
				AI	SS	COMPOSITE	ENGAGEMENT AND DISENGAGEMENT (MAX.)		DISENGAGEMENT (MIN.)	
				Nm	Lb.-in	Nm	Lb.-in			
09	18.40 (0.724)	11.90 (0.469)	21.80 (0.858)	15	36	9	0.9	8	0.2	2
11	21.10 (0.831)	14.90 (0.587)	25.00 (0.984)	20	50	13	1.4	12		
13	25.4 (1.000)	17.90 (0.705)	29.40 (1.157)	27	64	18	1.8	16		
15	28.70 (1.130)	21.90 (0.862)	32.50 (1.280)	34	80	23	2.3	20	0.3	3
17	32.20 (1.268)	24.90 (0.980)	35.70 (1.406)	37	88	25	2.7	24		
19	34.90 (1.374)	27.90 (1.098)	38.50 (1.516)	48	102	32	3.2	28		
21	38.10 (1.500)	30.90 (1.217)	41.70 (1.642)	55	117	35	3.6	32	0.6	5
23	41.10 (1.618)	33.90 (1.335)	44.90 (1.768)	67	131	41	4.1	36		
25	44.30 (1.744)	36.90 (1.453)	48.00 (1.890)	71	145	48	4.6	40		

DEUTSCH DTS and ACT Series Connectors

DEUTSCH Square Flange Receptacle to Plug

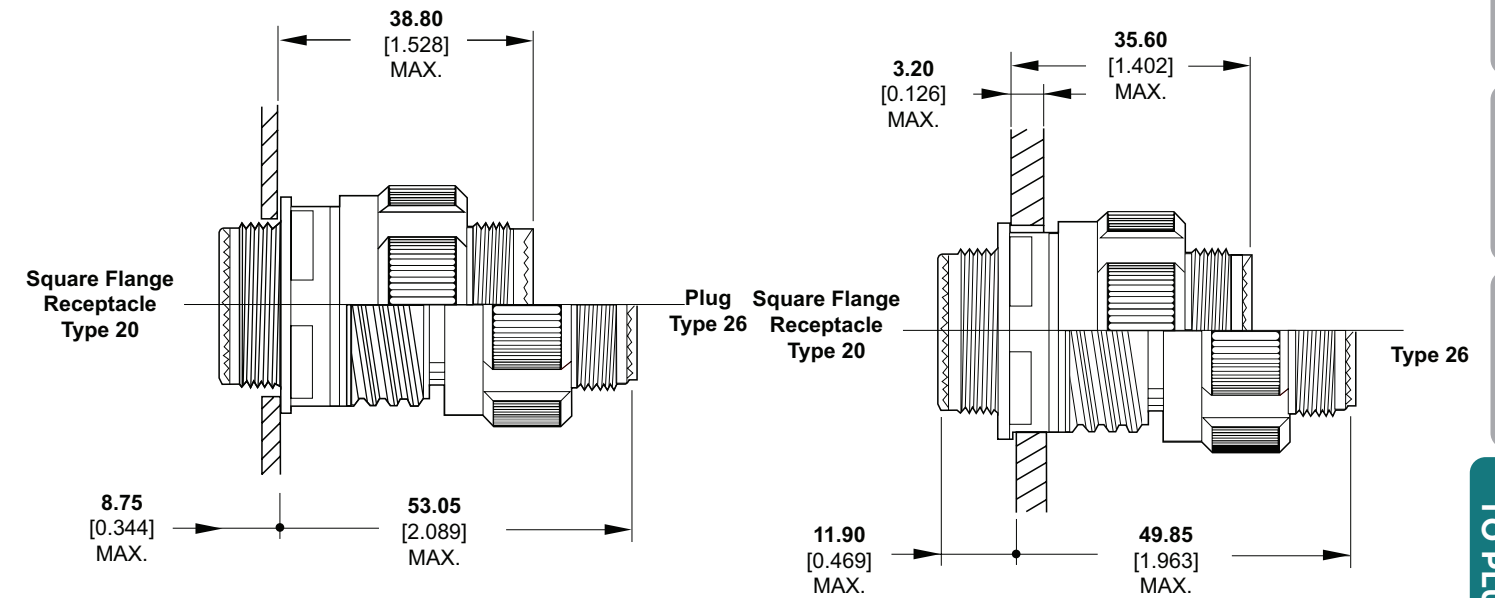

DEUTSCH Jam Nut Receptacle to Plug

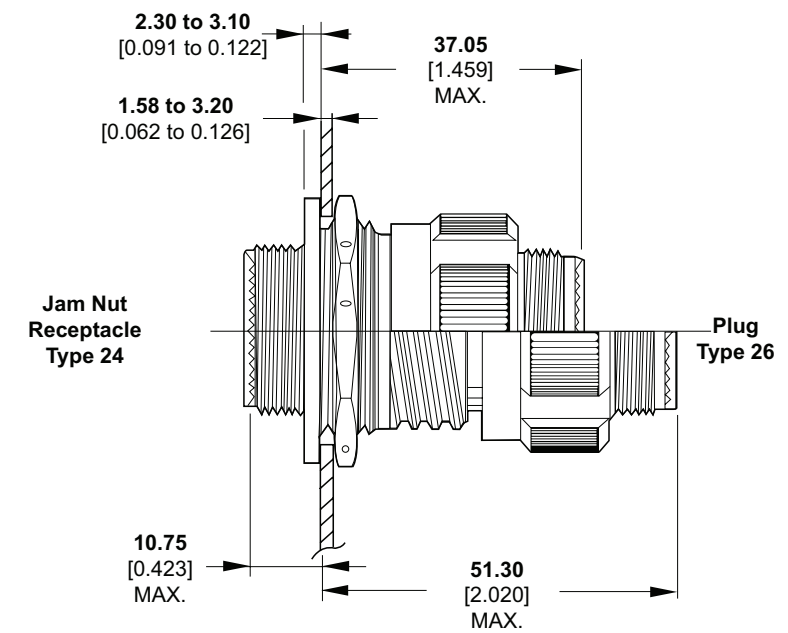

TYPE 20

TYPE 24

TYPE 26

RECEPTACLE TO PLUG

TYPE PR

PANEL CUTS

KEYING

TYPE 20

TYPE 24

TYPE 26

RECEPTACLE TO PLUG

TYPE PR

PANEL CUTS

KEYING

DEUTSCH DTS and ACT Series Connectors

DEUTSCH Dummy Receptacle - Type PR

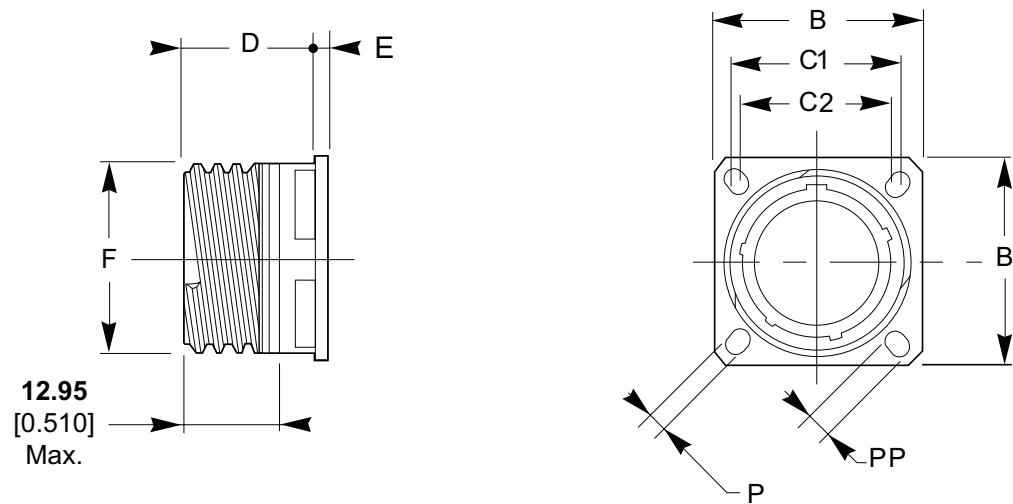

SHELL	B mm (in)	C1 mm (in)	C2 mm (in)	D MAX. mm (in)	E MAX. mm (in)	F mm (in)	G mm (in)	P mm (in)	pp mm (in)	MASS(g) BY SHELL TYPE		
										Al	SS	COMPOSITE
09	23.80 (0.937)	18.26 (0.719)	15.09 (0.594)	20.90 (0.823)	2.50 (0.098)	15.73 (0.619)	3.25 (0.128)	5.49 (0.216)	5.49 (0.216)	7	10	8
11	26.20 (1.031)	20.62 (0.812)	18.26 (0.719)	20.90 (0.823)	2.50 (0.098)	18.91 (0.744)	3.25 (0.128)	4.93 (0.194)	4.93 (0.194)	11	16	11
13	28.60 (1.126)	23.01 (0.906)	20.62 (0.812)	20.90 (0.823)	2.50 (0.098)	22.08 (0.869)	3.25 (0.128)	4.93 (0.194)	4.93 (0.194)	15	22	14
15	31.00 (1.220)	24.61 (0.969)	23.01 (0.906)	20.90 (0.823)	2.50 (0.098)	25.26 (0.994)	3.25 (0.128)	4.93 (0.194)	4.93 (0.194)	18	31	18
17	33.30 (1.311)	26.97 (1.062)	24.61 (0.969)	20.90 (0.823)	2.50 (0.098)	29.96 (1.180)	3.25 (0.128)	4.93 (0.194)	4.93 (0.194)	22	46	23
19	36.50 (1.437)	29.36 (1.156)	26.97 (1.062)	20.90 (0.823)	2.50 (0.098)	31.54 (1.242)	3.25 (0.128)	4.93 (0.194)	4.93 (0.194)	26	51	26
21	39.70 (1.563)	31.75 (1.250)	29.36 (1.156)	20.10 (0.791)	3.20 (0.126)	34.72 (1.367)	3.25 (0.128)	4.93 (0.194)	4.93 (0.194)	30	65	31
23	42.90 (1.689)	34.93 (1.375)	31.75 (1.250)	20.10 (0.791)	3.20 (0.126)	37.90 (1.492)	3.91 (0.154)	6.15 (0.242)	6.15 (0.242)	33	78	36
25	46.00 (1.811)	38.10 (1.500)	34.93 (1.375)	20.10 (0.791)	3.20 (0.126)	41.07 (1.617)	3.91 (0.154)	6.15 (0.242)	6.15 (0.242)	36	97	43

DEUTSCH DTS and ACT Series Connectors

Recommended Panel Cutouts

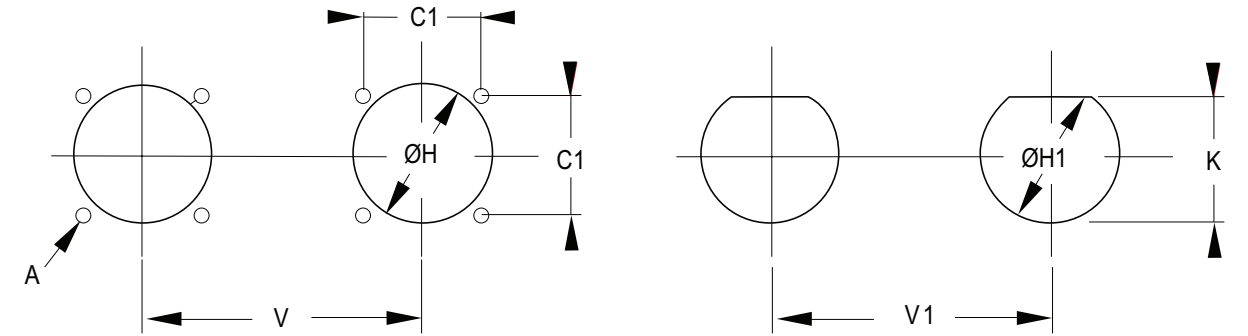

SHELL	A	C1 mm (in)	H MIN.		H1 MAX. mm (in)	K MAX. mm (in)	V mm (in)	V1 mm (in)
			FRONT mm (in)	REAR mm (in)				
09	3.25 (0.128)	18.26 (0.719)	13.11 (0.516)	16.66 (0.656)	17.78 (0.700)	16.70 (0.657)	25.58 (1.007)	20.20 (1.189)
11		20.62 (0.812)	15.08 (0.594)	22.22 (0.875)	20.88 (0.822)	19.53 (0.769)	27.00 (1.063)	32.60 (1.283)
13		23.01 (0.906)	19.05 (0.750)	23.42 (0.922)	25.58 (1.007)	24.26 (0.995)	30.20 (1.189)	36.00 (1.417)
15		24.61 (0.969)	23.01 (0.906)	26.59 (1.047)	28.80 (1.134)	27.53 (1.084)	33.30 (1.331)	39.60 (1.559)
17		26.97 (1.062)	25.81 (1.106)	30.96 (1.219)	31.98 (1.259)	30.68 (1.208)	36.50 (1.437)	43.30 (1.705)
19		29.36 (1.156)	28.98 (1.141)	32.94 (1.297)	35.15 (1.384)	33.86 (1.333)	39.30 (1.547)	47.00 (1.850)
21		31.75 (1.250)	32.16 (1.266)	36.12 (1.422)	38.28 (1.507)	37.06 (1.459)	42.50 (1.673)	50.60 (1.992)
23	3.91 (0.154)	34.93 (1.375)	34.93 (1.375)	39.29 (1.547)	41.50 (1.634)	40.01 (1.575)	45.70 (1.799)	54.20 (2.134)
25		38.10 (1.500)	37.69 (1.484)	42.47 (1.672)	44.68 (1.759)	43.41 (1.709)	48.80 (1.921)	59.70 (2.350)

Keying Options

SHELL SIZE	KEY POSITION	POLARIZATION (DEGREES)			
		A	B	C	D
09	N	105	140	215	265
	A	102	132	248	320
	B	80	118	230	312
	C	35	140	205	275
	D	64	155	234	304
11 13 15	E	91	131	197	240
	N	95	141	208	236
	A	113	156	182	292
	B	90	145	195	252
	C	53	156	220	255
17 19 21 23 25	D	119	146	176	298
	E	51	141	184	242
	N	80	142	196	293
	A	135	170	200	310
	B	49	169	200	244
	C	66	140	200	257
	D	62	145	180	280
	E	79	153	197	272

Viewed from Mating Face of the Receptacle Connector

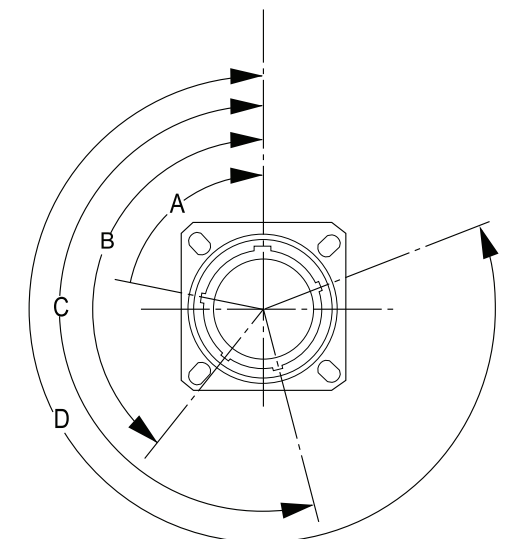

VG Approved Backshells & Accessories

Introduction

TE supplies a comprehensive range of circular backshells and accessories that can assist in providing effective strain relief, environmental sealing, and electromagnetic interference (EMI)/radio frequency interference (RFI) shielding. These help you meet today's challenges in demanding environments, across many applications / markets.

From 2018 TE has been supplying its POLAMCO backshells to the widely accepted VG standard. In order to support customers TE also offers the PVG range further expanding the customer options i.e. entry size options, plating options.



CHARACTERISTICS

- Backshells for individual or overall 360° screening options
- All parts machined from solid material for reliable strength and performance
- Available in all materials and straight, 45° or 90° options
- Interfaces with VG 96938, VG 95319-1006, VG 95319-1007, VG 95319-1008
- Heat shrink boot adaptor, or groove to suit heat shrink boot
- Low profile, extended length and alternative angles options

VG Approved Backshells & Accessories

TERMINATION STYLES

There are a variety of methods for terminating screening braid to backshells, many of which are covered within TE's standard range of backshells shown below.

Band

Band clamped with calibrated tool

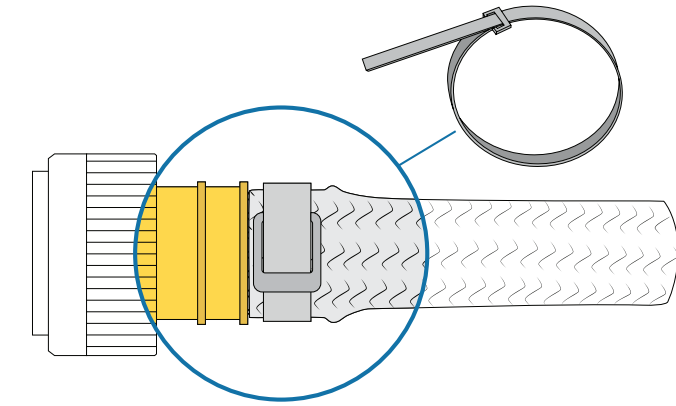

Cone

Product supplied with pre-terminated braid tail

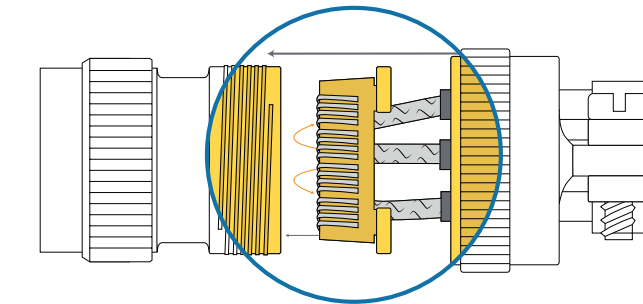

BACKSHELLS APPROVED TO VG95319-1011

- **VG 95319-1011A001A** Band Termination
- **VG 95319-1011B001A** Band Termination
- **VG 95319-1011G001A** Band Termination
- **VG 95319-1011H001A** Band Termination
- **VG 95319-1011D001A** Band Termination
- **VG 95319-1011C001A** Cone Termination
- **VG 95319-1011F001A** Cone Termination
- **VG 95319-1011E001A** Heat Shrink Boot

VG Approved Backshells & Accessories



1011A & 1001B - BANDING BACKSHELLS

TE's banding backshells offer a quick and easy way to terminate harness EMI shield using a stainless steel band strap. Sealing and strain relief can be achieved with the use of a heat shrink boot. VG band straps and heat shrink boot accessories are also available from TE.



1011C & 1011F - CONE TERMINATION

TE's cone backshells provide a versatile solution for repairable applications where high performance is required. The cone termination platform covers overall screening, individual screening, and a combination of both. The range includes some variants which have sealing options and strain relief clamps.



1011D - LOW PROFILE BANDING

TE's banding backshells offer a quick and easy way to terminate harness EMI shield using a stainless steel band strap, with the low profile option helping with tight space envelopes. Sealing and strain relief can be achieved with the use of a heat shrink boot. VG band strap and heat shrink boot accessories are also available from TE.



1011E - HEAT SHRINK BOOT BACKSHELL

TE's environmental sealing backshell is designed to use a VG heat shrink boot. The integral groove and knurled rear provides a feature best suited for location of the boot.



1011G & 1011H - BANDING BACKSHELL WITH SPANNER FLATS

TE's banding backshells offer a quick and easy way to terminate harness EMI shield using a stainless steel band strap, with spanner flats aiding ease of assembly. Sealing and strain relief can be achieved with the use of a heat shrink boot. VG band strap and heat shrink boot accessories are also available from TE.



1015A - BAND STRAPS

TE's band strap can be used on most military circular connectors with suitable backshell, including MIL-DTL-38999.

The band strap termination system provides ease of installation and repair. TE offers the corrosion-resisting steel bands in various types to help meet your shield termination needs and termination tool of your choice.

VG 95319-1011A001A - Band Termination

Interfaces with VG 96938, VG 95319-1006, VG 95319-1007, VG 95319-1008

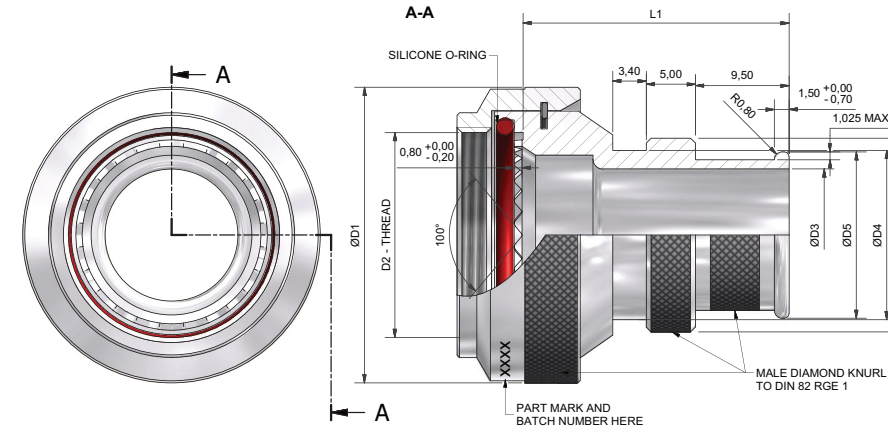

VG Part Numbering

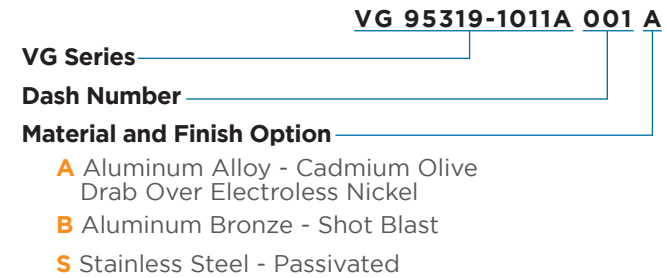

Commercial Part Numbering

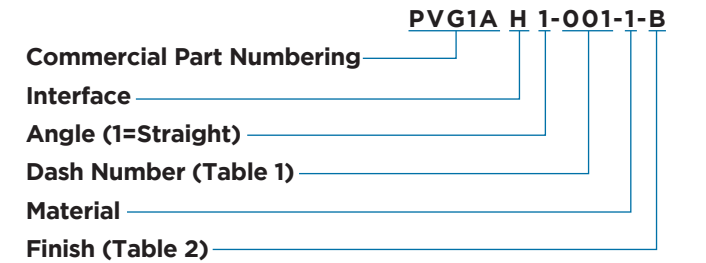

Table 1

DASH NO.	SHELL SIZE	D1 MAX	D2	D3 3 0,2	D4 3 0,1	D5 3 0,1	D6 3 0,1	L1 3 0,8	NO. OF TEETH	MASS (g) MAX
001	09	19,5	M12 X 1	9,0	12,8	12,5	15,3	27,0	12,0	20,0
011	11	23,0	M15 X 1	9,5	13,3	13,0	15,8	38,0	16,0	20,0
002	11	23,0	M15 X 1	12,5	16,3	16,0	18,8	27,0	16,0	20,0
012	13	25,9	M18 X 1	9,5	13,3	13,0	15,8	38,0	20,0	20,0
003	13	25,9	M18 X 1	12,0	15,8	15,5	18,3	27,0	20,0	20,0
013	15	30,2	M22 X 1	9,5	13,3	13,0	15,8	38,0	24,0	20,0
004	15	30,2	M22 X 1	13,5	17,3	17,0	19,8	27,0	24,0	20,0
005	17	33,0	M25 X 1	12,8	16,6	16,3	19,1	38,0	28,0	30,0
006	17	33,0	M25 X 1	23,5	27,3	26,9	29,8	38,0	28,0	30,0
014	19	35,9	M28 X 1	17,5	21,3	21,0	23,8	38,0	32,0	30,0
007	19	35,9	M28 X 1	18,0	21,8	21,6	24,3	38,0	32,0	30,0
015	21	39,2	M31 X 1	13,0	16,8	16,5	19,3	38,0	36,0	30,0
016	21	39,2	M31 X 1	16,0	19,8	19,5	22,3	38,0	36,0	30,0
008	21	39,2	M31 X 1	19,0	22,8	22,6	25,3	38,0	36,0	30,0
017	23	42,4	M34 X 1	19,0	22,8	22,5	25,3	38,0	40,0	30,0
009	23	42,4	M34 X 1	23,0	26,8	26,4	29,3	38,0	40,0	40,0
018	25	45,0	M37 X 1	16,0	19,8	19,5	22,3	38,0	44,0	40,0
019	25	45,0	M37 X 1	19,0	22,8	22,5	25,3	38,0	44,0	40,0
020	25	45,0	M37 X 1	22,5	26,3	26,0	28,8	38,0	44,0	40,0
010	25	45,0	M37 X 1	28,5	32,3	32,0	34,8	38,0	44,0	40,0

NOTE:
 • All dimensions in mm.

Table 2

CODE	FINISH
C	ELECTROLESS NICKEL
B	CADMIUM OLIVE DRAB OVER ELECTROLESS NICKEL
ZB	ZINC COBALT OLIVE DRAB OVER ELECTROLESS NICKEL
ZN	ZINC NICKEL BLACK PASSIVATE OVER ELECTROLESS NICKEL
SEE SS0076 FOR FULL RANGE OF FINISH OPTIONS	

NOTE:
 • Any options outside those possible with VG Part Number are available but will not be VG approved parts. For full list of material and plating options please visit our website.



VG Bandstraps - Sold separately. See page 94 for more details.

VG 95319-1011B001A - Band Termination (90°)

Interfaces with VG 95319-1006, VG 95319-1007, VG 95319-1008

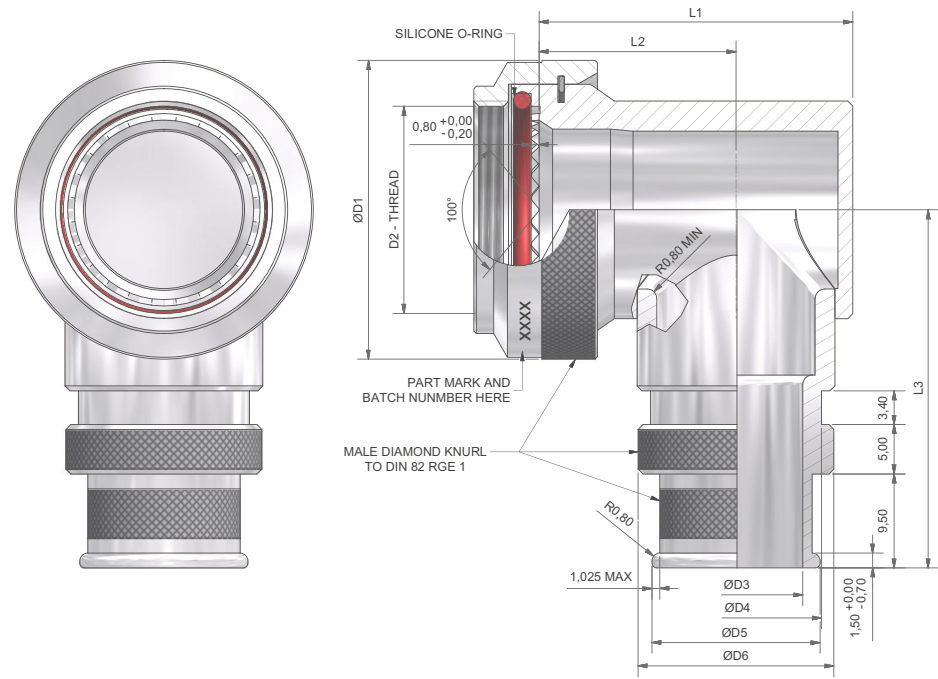

VG Part Numbering

VG 95319-1011B 001 A

- VG Series** — VG 95319
- Dash Number** — 1011B
- Material and Finish Option** — 001 A
 - A** Aluminum Alloy - Cadmium Olive Drab Over Electroless Nickel
 - B** Aluminum Bronze - Shot Blast
 - S** Stainless Steel - Passivated

Table 1

DASH NO.	SHELL SIZE	ØD1 MAX	D2	ØD3 3 0,025	ØD4 3 0,1	ØD5 3 0,1	ØD6 3 0,1	L1 MAX	L2 MAX	L3 MAX	NO. OF TEETH	MASS (g) MAX
001	09	19,5	M12 X 1	9,0	12,8	12,5	15,3	24,0	16,4	31,2	12,0	30,0
002	11	23,0	M15 X 1	12,5	16,3	16,0	18,8	27,8	18,4	32,8	16,0	30,0
003	13	25,9	M18 X 1	12,0	15,8	15,5	18,3	29,5	20,0	34,2	20,0	35,0
004	15	30,2	M22 X 1	13,5	17,3	17,0	19,8	31,9	21,2	36,4	24,0	45,0
005	17	33,0	M25 X 1	12,8	16,6	16,3	19,1	35,0	22,8	37,8	28,0	55,0
006	17	33,0	M25 X 1	23,5	27,3	26,9	29,8	37,7	22,8	37,8	28,0	55,0
007	19	35,9	M28 X 1	18,0	21,8	21,6	24,3	37,4	24,0	39,2	32,0	65,0
008	21	39,2	M31 X 1	19,0	22,8	22,6	25,3	40,6	25,6	40,9	36,0	75,0
009	23	42,4	M34 X 1	23,0	26,8	26,4	29,3	43,8	27,1	42,5	40,0	85,0
010	25	45,0	M37 X 1	28,5	32,3	32,0	34,8	46,3	28,4	43,8	44,0	95,0

NOTE:
• All dimensions in mm.

Commercial Part Numbering

PVG1B H 3-001-1-B

- Commercial Part Numbering** — PVG1B H 3-001-1-B
- Interface** — H
- Angle (3=90°)** — 3
- Dash Number (Table 1)** — 001
- Material** — B
- Finish (Table 2)** — B

Table 2

CODE	FINISH
C	ELECTROLESS NICKEL
B	CADMIUM OLIVE DRAB OVER ELECTROLESS NICKEL
ZB	ZINC COBALT OLIVE DRAB OVER ELECTROLESS NICKEL
ZN	ZINC NICKEL BLACK PASSIVATE OVER ELECTROLESS NICKEL
SEE SS0076 FOR FULL RANGE OF FINISH OPTIONS	

NOTE:
• Any options outside those possible with VG Part Number are available but will not be VG approved parts. For full list of material and plating options please visit our website.

VG 95319-1011C001A - Cone Termination

Interfaces with VG 95319-1006, VG 95319-1007, VG 95319-1008

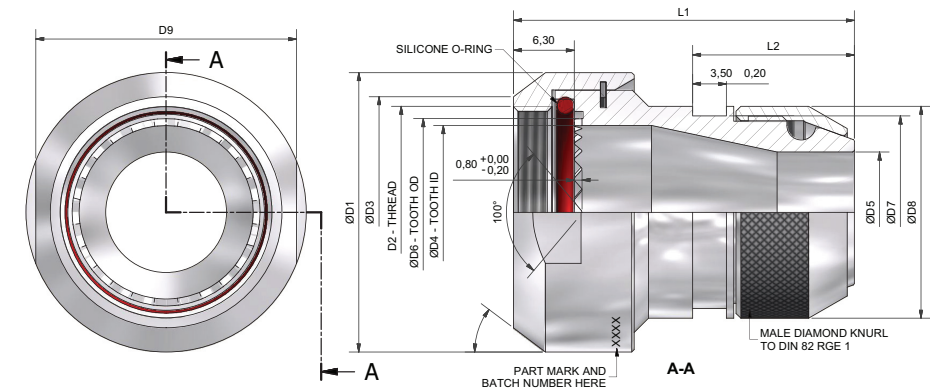

VG Part Numbering

VG 95319-1011C 001 A

- VG Series** — VG 95319
- Dash Number** — 1011C
- Material and Finish Option** — 001 A
 - A** Aluminum Alloy - Cadmium Olive Drab Over Electroless Nickel
 - B** Aluminum Bronze - Shot Blast
 - S** Stainless Steel - Passivated

Commercial Part Numbering

PVG1C H 1-001-1-B

- Commercial Part Numbering** — PVG1C H 1-001-1-B
- Interface** — H
- Angle (1 = Straight)** — 1
- Dash Number (Table 1)** — 001
- Material** — B
- Finish (Table 2)** — B

Table 1

DASH NO.	SHELL SIZE	ØD1 30,2	D2	ØD3 +0,2/-0,1	ØD4 +0,2/-0	ØD5 MIN	ØD6 +0,2/-0	ØD7 +0/-0,3	ØD8 +0,5/-0	L1 MAX	L2 MAX	α 31°	D9 +0/-0,2	NO. OF TEETH	MASS (g) MAX
001	09	19,0	M12 X 1	14,25	8,5	6,2	10,8	12,0	14,0	34,0	16,2	35°	17,0	12	12,0
002	11	22,0	M15 X 1	17,00	12,0	7,0	13,8	14,0	16,0	35,0	17,2	37°	20,0	16	15,0
003	11	22,0	M15 X 1	17,00	12,0	9,5	13,8	16,0	18,0	35,0	17,2	37°	20,0	16	17,0
004	11	22,0	M15 X 1	17,00	12,0	12,5	13,8	20,0	22,0	36,0	18,2	37°	20,0	16	17,0
005	13	25,0	M18 X 1	20,00	13,8	9,5	16,8	16,0	18,0	35,0	17,2	37°	23,0	20	18,0
006	15	29,0	M22 X 1	24,00	18,0	12,5	20,8	20,0	22,0	36,0	18,2	37°	27,0	24	23,0
007	15	29,0	M22 X 1	24,00	18,0	9,5	20,8	16,0	18,0	36,0	18,2	37°	27,0	24	23,0
008	15	29,0	M22 X 1	24,00	18,0	15,5	20,8	23,0	25,0	36,0	18,2	37°	27,0	24	25,0
009	17	32,0	M25 X 1	27,00	21,1	15,5	23,8	23,0	25,0	36,0	18,2	37°	30,0	28	27,0
010	17	32,0	M25 X 1	27,00	21,1	7,0	23,8	14,0	16,0	35,0	17,2	37°	30,0	28	25,0
011	19	36,0	M28 X 1	30,00	24,1	18,5	26,8	24,5	28,0	36,0	18,2	40°	34,0	32	35,0
012	21	39,0	M31 X 1	33,00	27,1	21,5	29,8	28,5	32,0	36,0	18,2	40°	37,0	36	42,0
013	23	43,0	M34 X 1	36,00	30,1	23,5	32,8	30,5	34,0	36,0	18,2	40°	41,0	40	45,0
014	23	43,0	M34 X 1	36,00	30,1	15,5	32,8	23,0	25,0	36,0	18,2	40°	41,0	40	43,0
015	25	46,0	M37 X 1	39,00	33,3	27,5	35,8	34,0	38,0	36,0	18,2	40°	44,0	44	52,0

NOTE:
• All dimensions in mm.

Table 2

CODE	FINISH
C	ELECTROLESS NICKEL
B	CADMIUM OLIVE DRAB OVER ELECTROLESS NICKEL
ZB	ZINC COBALT OLIVE DRAB OVER ELECTROLESS NICKEL
ZN	ZINC NICKEL BLACK PASSIVATE OVER ELECTROLESS NICKEL
SEE SS0076 FOR FULL RANGE OF FINISH OPTIONS	

NOTE:
• Any options outside those possible with VG Part Number are available but will not be VG approved parts. For full list of material and plating options please visit our website.

VG 95319-1011D001A - Band Termination

Low Profile / Step-Up Entry

Interfaces with VG 96938, VG 95319-1006, VG 95319-1007, VG 95319-1008

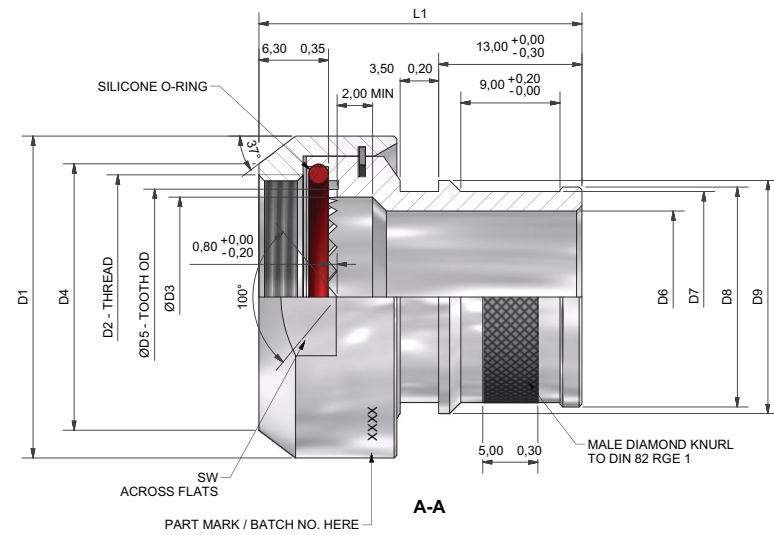

VG Part Numbering

VG 95319-1011D 001 A

- VG Series
- Dash Number
- Material and Finish Option
 - A Aluminum Alloy - Cadmium Olive Drab Over Electroless Nickel
 - B Aluminum Bronze - Shot Blast
 - S Stainless Steel - Passivated

Commercial Part Numbering

PVG1D H 1-001-1-B

- Commercial Part Numbering
- Interface (MIL-DTL-38999 Series III and IV)
- Angle (1 = Straight)
- Dash Number (Table 1)
- Material
- Finish (Table 2)

Table 1

DASH NO.	SHELL SIZE	D1 30,2	D2	D3 +0,2/-0	D4 +0,2/-0,1	D5 +0,2/-0	D6 +0,5/-0	D7 30,1	D8 +0/-0,15	D9 30,1	L1 MAX	α 31°	SW +0/-0,2	NO. OF TEETH	MASS (g) MAX
001	09	19	M12 X 1	8,5	14,25	10,8	19,0	22,5	23,3	24,5	32,0	35°	17	12	20
002	11	22	M15 X 1	12,0	17,00	13,8	9,5	13,0	13,8	15,0	30,0	37°	20	16	12
003	11	22	M15 X 1	12,0	17,00	13,8	22,0	24,8	25,6	28,3	32,0	37°	20	16	25
004	13	25	M18 X 1	13,8	20,00	16,8	25,0	28,5	29,3	32,0	32,0	37°	23	20	30
005	15	29	M22 X 1	18,0	24,00	20,8	15,5	19,0	19,8	21,0	30,0	37°	27	24	30
006	15	29	M22 X 1	18,0	24,00	20,8	17,5	21,0	21,8	23,0	30,0	37°	27	24	30
007	17	32	M25 X 1	21,1	27,00	23,8	28,5	32,0	32,8	35,5	32,0	37°	30	28	35
008	19	36	M28 X 1	24,1	30,00	26,8	22,0	24,8	25,6	28,3	31,0	40°	34	32	35
009	21	39	M31 X 1	27,1	33,00	29,8	25,0	28,5	29,3	32,0	34,0	40°	37	36	40
010	23	43	M34 X 1	30,1	36,00	32,8	12,7	16,5	17,0	18,2	34,0	40°	41	40	40
011	25	46	M37 X 1	33,3	39,00	35,8	17,5	21,0	21,8	23,0	34,0	40°	44	44	40

NOTE: All dimensions in mm.

Table 2

CODE	FINISH
C	ELECTROLESS NICKEL
B	CADMIUM OLIVE DRAB OVER ELECTROLESS NICKEL
ZB	ZINC COBALT OLIVE DRAB OVER ELECTROLESS NICKEL
ZN	ZINC NICKEL BLACK PASSIVATE OVER ELECTROLESS NICKEL
SEE SS0076 FOR FULL RANGE OF FINISH OPTIONS	

NOTE: Any options outside those possible with VG Part Number are available but will not be VG approved parts. For full list of material and plating options please visit our website.

VG 95319-1011E001A - Heat Shrink Boot Backshell

Interfaces with VG 96938, VG 95319-1006, VG 95319-1007, VG 95319-1008

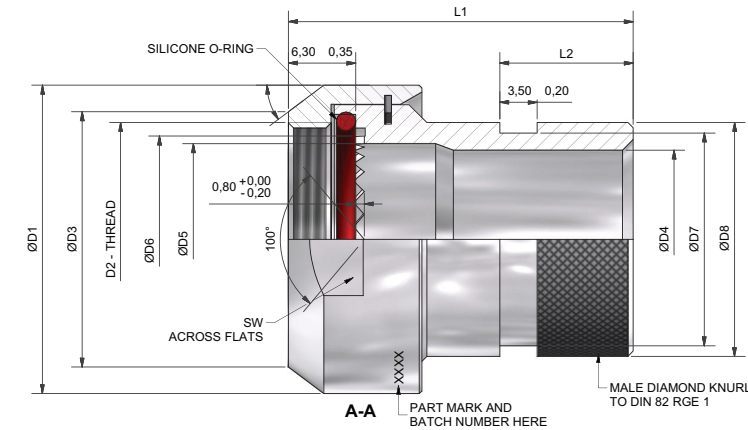

VG Part Numbering

VG 95319-1011E 001 A

- VG Series
- Dash Number
- Material and Finish Option
 - A Aluminum Alloy - Cadmium Olive Drab Over Electroless Nickel
 - B Aluminum Bronze - Shot Blast
 - S Stainless Steel - Passivated

Commercial Part Numbering

PVG1E H 1-001-1-B

- Commercial Part Numbering
- Interface
- Angle (1 = Straight)
- Dash Number (Table 1)
- Material
- Finish (Table 2)

Table 1

DASH NO.	SHELL SIZE	ØD1 30,2	D2	ØD3 +0,2/-0,1	ØD4 +0,2/-0	ØD5 +0,2/-0	ØD6 +0,2/-0	ØD7 +0/-0,2	ØD8 +0,5/-0	L1 MAX	L2 +0/-0,4	α 31°	SW +0/-0,2	NO. OF TEETH	MASS (g) MAX
001	09	19	M12 X 1	14,25	8,65	8,50	10,80	12,00	14,00	33,00	12,50	35°	17	12	10
002	11	22	M15 X 1	17,00	12,00	12,00	13,80	14,00	16,00	33,00	12,50	37°	20	16	12
003	13	25	M18 X 1	20,00	13,80	13,80	16,80	16,00	18,00	33,00	12,50	37°	23	20	14
004	15	29	M22 X 1	24,00	16,80	18,00	20,80	20,00	22,00	33,00	12,50	37°	27	24	17
005	17	32	M25 X 1	27,00	19,80	21,10	23,80	23,00	25,00	33,00	12,50	37°	30	28	20
006	19	36	M28 X 1	30,00	22,80	24,10	26,80	24,50	28,00	33,00	12,50	40°	34	32	30
007	21	39	M31 X 1	33,00	25,80	27,10	29,80	28,50	32,00	33,00	15,00	40°	37	36	40
008	23	43	M34 X 1	36,00	26,80	30,10	32,80	30,50	34,00	33,00	15,00	40°	41	40	45
009	25	46	M37 X 1	39,00	30,80	33,30	35,80	34,50	38,00	33,00	15,00	40°	44	44	50

NOTE: All dimensions in mm.

Table 2

CODE	FINISH
C	ELECTROLESS NICKEL
B	CADMIUM OLIVE DRAB OVER ELECTROLESS NICKEL
ZB	ZINC COBALT OLIVE DRAB OVER ELECTROLESS NICKEL
ZN	ZINC NICKEL BLACK PASSIVATE OVER ELECTROLESS NICKEL
SEE SS0076 FOR FULL RANGE OF FINISH OPTIONS	

NOTE: Any options outside those possible with VG Part Number are available but will not be VG approved parts. For full list of material and plating options please visit our website.

VG 95319-1011F001A - Cone Termination

Interfaces with VG 95319-1006, VG 95319-1007, VG 95319-1008

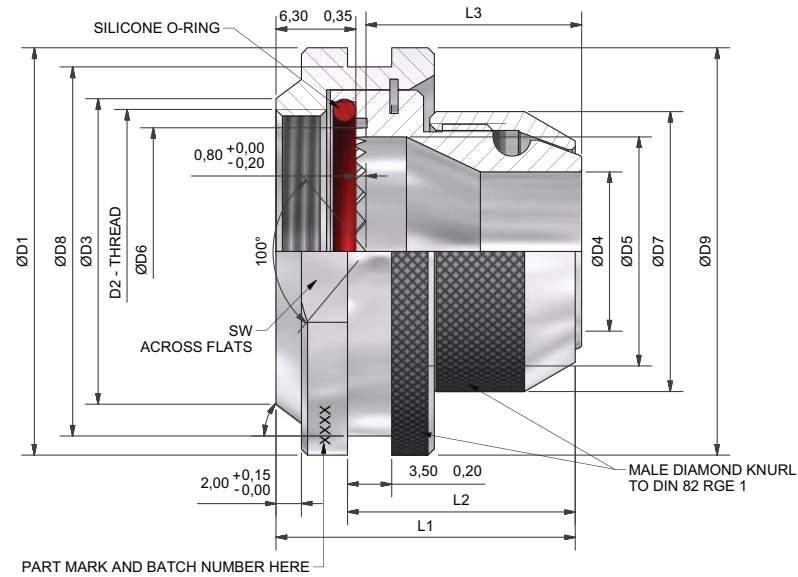

VG Part Numbering

VG 95319-1011F 001 A

- VG Series**
- Dash Number**
- Material and Finish Option**
 - A** Aluminum Alloy - Cadmium Olive Drab Over Electroless Nickel
 - B** Aluminum Bronze - Shot Blast
 - S** Stainless Steel - Passivated

Commercial Part Numbering

PVG1F H 1-001-1-B

- Commercial Part Numbering**
- Interface**
- Angle (1 = Straight)**
- Dash Number (Table 1)**
- Material**
- Finish (Table 2)**

Table 1

DASH NO.	SHELL SIZE	ØD1 30,2	D2	ØD3 +0,2/-0,1	ØD4 +0,2/-0	ØD5 +0,2/-0	ØD6 +0,2/-0	ØD7 30,5	ØD8 +0/-0,2	ØD9 +0,5/-0	L1 30,5	L2 +0/-1	L3 30,5	α 31°	SW +0/-0,2	NO. OF TEETH	MASS (g) MAX
001	09	22,0	M12 X 1	14,25	6,2	8,5	10,8	14,0	19,0	21,0	23,0	18,0	16,0	35°	20,0	12,0	12,0
002	11	25,0	M15 X 1	17,00	7,0	12,0	13,8	16,0	22,0	24,0	23,0	18,0	16,0	37°	23,0	16,0	15,0
003	13	29,0	M18 X 1	20,00	9,5	13,8	16,8	18,0	25,5	28,0	24,0	19,0	17,0	37°	27,0	20,0	18,0
004	13	29,0	M18 X 1	20,00	15,5	13,8	16,8	25,0	25,5	28,0	23,0	18,0	16,0	37°	27,0	20,0	22,0
005	15	32,0	M22 X 1	24,00	12,5	18,0	20,8	22,0	29,0	32,0	24,0	19,0	17,0	37°	30,0	24,0	22,0
006	15	32,0	M22 X 1	24,00	15,5	18,0	20,8	25,0	29,0	32,0	24,0	19,0	17,0	37°	30,0	24,0	22,0
007	17	36,0	M25 X 1	27,00	15,5	21,1	23,8	25,0	32,5	36,0	24,0	19,0	17,0	37°	34,0	28,0	27,0
008	19	39,0	M28 X 1	30,00	18,5	24,1	26,8	28,0	35,5	39,0	24,0	19,0	17,0	40°	37,0	32,0	30,0
009	19	39,0	M28 X 1	30,00	15,5	24,1	26,8	25,0	35,5	39,0	25,0	20,0	18,0	40°	37,0	32,0	30,0
010	21	42,0	M31 X 1	33,00	21,0	27,1	29,8	32,0	38,5	42,0	24,0	19,0	17,0	40°	40,0	36,0	40,0
011	23	45,0	M34 X 1	36,00	23,5	30,1	32,8	34,0	42,0	45,5	24,0	19,0	17,0	40°	43,0	40,0	45,0
012	25	49,0	M37 X 1	39,00	27,5	33,3	35,8	38,0	45,5	49,0	24,0	19,0	17,0	40°	47,0	44,0	50,0

NOTE: All dimensions in mm.

Table 2

CODE	FINISH
C	ELECTROLESS NICKEL
B	CADMIUM OLIVE DRAB OVER ELECTROLESS NICKEL
ZB	ZINC COBALT OLIVE DRAB OVER ELECTROLESS NICKEL
ZN	ZINC NICKEL BLACK PASSIVATE OVER ELECTROLESS NICKEL
SEE SS0076 FOR FULL RANGE OF FINISH OPTIONS	

NOTE: Any options outside those possible with VG Part Number are available but will not be VG approved parts. For full list of material and plating options please visit our website.

VG 95319-1011G001A - Band Termination

Interfaces with VG 96938, VG 95319-1006, VG 95319-1007, VG 95319-1008

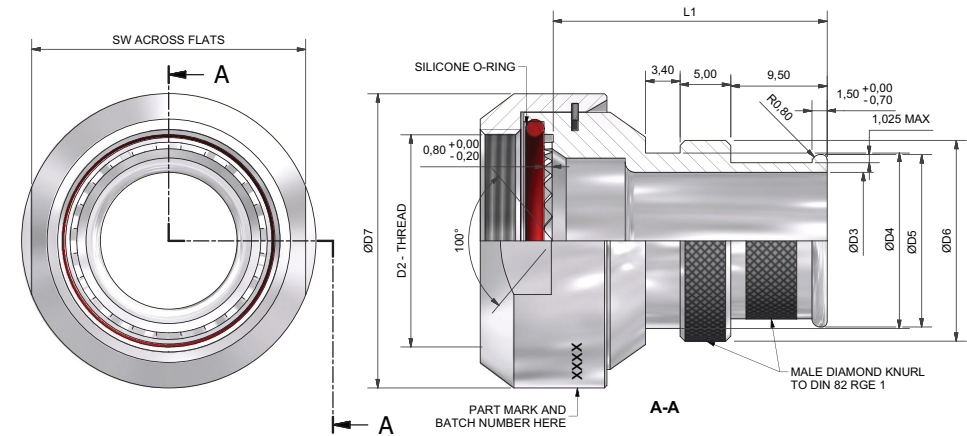

VG Part Numbering

VG 95319-1011G 001 A

- VG Series**
- Dash Number**
- Material and Finish Option**
 - A** Aluminum Alloy - Cadmium Olive Drab Over Electroless Nickel
 - B** Aluminum Bronze - Shot Blast
 - S** Stainless Steel - Passivated

Commercial Part Numbering

PVG1G H 1-001-1-B

- Commercial Part Numbering**
- Interface**
- Angle (1 = Straight)**
- Dash Number (Table 1)**
- Material**
- Finish (Table 2)**

Table 1

DASH NO.	SHELL SIZE	ØD1 30,2	D2	ØD3 +0,2/-0,1	ØD4 +0,2/-0	ØD5 +0,2/-0	ØD6 +0,2/-0	ØD7 30,5	α 31°	SW +0/-0,2	L1 30,5	NO. OF TEETH	MASS (g) MAX
001	09	M12 X 1	9,0	3 0,025	12,8	12,5	15,3	19,0	35°	17,0	27,0	12,0	20,0
011	11	M15 X 1	9,5	3 0,2	13,3	13,0	15,8	22,0	37°	20,0	38,0	16,0	20,0
002	11	M15 X 1	12,5	3 0,025	16,3	16,0	18,8	22,0	37°	20,0	27,0	16,0	20,0
012	13	M18 X 1	9,5	3 0,2	13,3	13,0	15,8	25,0	37°	23,0	38,0	20,0	20,0
003	13	M18 X 1	12,0	3 0,025	15,8	15,5	18,3	25,0	37°	23,0	27,0	20,0	20,0
013	15	M22 X 1	9,5	3 0,2	13,3	13,0	15,8	29,0	37°	27,0	38,0	24,0	20,0
004	15	M22 X 1	13,5	3 0,025	17,3	17,0	19,8	29,0	37°	27,0	27,0	24,0	20,0
005	17	M25 X 1	12,8	3 0,025	16,6	16,3	19,1	32,0	37°	30,0	38,0	28,0	30,0
006	17	M25 X 1	23,5	3 0,025	27,3	26,9	29,8	32,0	37°	30,0	38,0	28,0	30,0
014	19	M28 X 1	17,5	3 0,2	21,3	21,0	23,8	36,0	40°	34,0	38,0	32,0	30,0
007	19	M28 X 1	18,0	3 0,025	21,8	21,6	24,3	36,0	40°	34,0	38,0	32,0	30,0
015	21	M31 X 1	13,0	3 0,2	16,8	16,5	19,3	39,0	40°	37,0	38,0	36,0	30,0
016	21	M31 X 1	16,0	3 0,2	19,8	19,5	22,3	39,0	40°	37,0	38,0	36,0	30,0
008	21	M31 X 1	19,0	3 0,025	22,8	22,6	25,3	39,0	40°	37,0	38,0	36,0	30,0
017	23	M34 X 1	19,0	3 0,2	22,8	22,5	25,3	43,0	40°	41,0	38,0	40,0	30,0
009	23	M34 X 1	23,0	3 0,025	26,8	26,4	29,3	43,0	40°	41,0	38,0	40,0	40,0
018	25	M37 X 1	16,0	3 0,2	19,8	19,5	22,3	46,0	40°	44,0	38,0	44,0	40,0
019	25	M37 X 1	19,0	3 0,2	22,8	22,5	25,3	46,0	40°	44,0	38,0	44,0	40,0
020	25	M37 X 1	22,5	3 0,2	26,3	26,0	28,8	46,0	40°	44,0	38,0	44,0	40,0
010	25	M37 X 1	28,5	3 0,025	32,3	32,0	34,8	46,0	40°	44,0	38,0	44,0	40,0

NOTE: All dimensions in mm.

Table 2

CODE	FINISH
C	ELECTROLESS NICKEL
B	CADMIUM OLIVE DRAB OVER ELECTROLESS NICKEL
ZB	ZINC COBALT OLIVE DRAB OVER ELECTROLESS NICKEL
ZN	ZINC NICKEL BLACK PASSIVATE OVER ELECTROLESS NICKEL
SEE SS0076 FOR FULL RANGE OF FINISH OPTIONS	

NOTE: Any options outside those possible with VG Part Number are available but will not be VG approved parts. For full list of material and plating options please visit our website.

VG 95319-1011H001A - Band Termination (90°)

Interfaces with VG 95319-1006, VG 95319-1007, VG 95319-1008

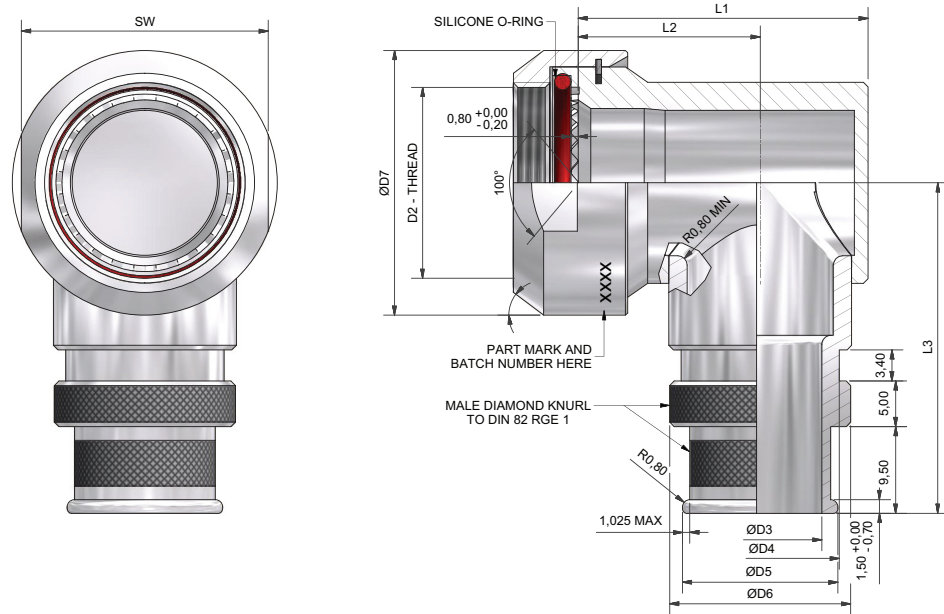

VG Part Numbering

VG 95319-1011H 001 A

- VG Series** — VG 95319-1011H
- Dash Number** — 001
- Material and Finish Option** — A
- A** Aluminum Alloy - Cadmium Olive Drab Over Electroless Nickel
- B** Aluminum Bronze - Shot Blast
- S** Stainless Steel - Passivated

Commercial Part Numbering

PVG1H H 3-001-1-B

- Commercial Part Numbering** — PVG1H H 3-001-1-B
- Interface** — H
- Angle (3 = 90°)** — 3
- Dash Number (Table 1)** — 001
- Material** — 1
- Finish (Table 2)** — B

Table 1

DASH NO.	SHELL SIZE	D2	ØD3	ØD3 TOL.	ØD4 3 0,1	ØD5 3 0,1	ØD6 3 0,1	ØD7 3 0,2	α 31°	SW +0/-0,2	L1 MAX	L2 MAX	L3 MAX	NO. OF TEETH	MASS (g) MAX
001	9	M12 X 1	9,0	3 0,025	12,8	12,5	15,3	19,0	35°	17,0	24,0	16,4	31,2	12,0	30,0
002	11	M15 X 1	12,5	3 0,025	16,3	16,0	18,8	22,0	37°	20,0	27,8	18,4	32,8	16,0	30,0
003	13	M18 X 1	12,0	3 0,025	15,8	15,5	18,3	22,0	37°	23,0	29,5	20,0	34,2	20,0	35,0
004	15	M22 X 1	13,5	3 0,025	17,3	17,0	19,8	25,0	37°	27,0	31,9	21,2	36,4	24,0	45,0
005	17	M25 X 1	12,8	3 0,025	16,6	16,3	19,1	29,0	37°	30,0	35,0	22,8	37,8	28,0	55,0
006	17	M25 X 1	23,5	3 0,025	27,3	26,9	29,8	29,0	37°	30,0	37,7	22,8	37,8	28,0	55,0
007	19	M28 X 1	18,0	3 0,025	21,8	21,6	24,3	32,0	40°	34,0	37,4	24,0	39,2	32,0	65,0
008	21	M31 X 1	19,0	3 0,025	22,8	22,6	25,3	36,0	40°	37,0	40,6	25,6	40,9	36,0	75,0
009	23	M34 X 1	23,0	3 0,025	26,8	26,4	29,3	39,0	40°	41,0	43,8	27,1	42,5	40,0	85,0
010	25	M37 X 1	28,5	3 0,025	32,3	32,0	34,8	43,0	40°	44,0	46,3	28,4	43,8	44,0	95,0

NOTE:

• All dimensions in mm.

Table 2

CODE	FINISH
C	ELECTROLESS NICKEL
B	CADMIUM OLIVE DRAB OVER ELECTROLESS NICKEL
ZB	ZINC COBALT OLIVE DRAB OVER ELECTROLESS NICKEL
ZN	ZINC NICKEL BLACK PASSIVATE OVER ELECTROLESS NICKEL
SEE SS0076 FOR FULL RANGE OF FINISH OPTIONS	

NOTE:

• Any options outside those possible with VG Part Number are available but will not be VG approved parts. For full list of material and plating options please visit our website.

VG 95319-1015A Band Straps



TE offers a selection of VG qualified banding straps. The VG band strap can be used on most military circular connectors with suitable backshell, including MIL-DTL-38999.

The band strap termination system provides ease of installation and repair. TE offers the corrosion-resisting steel bands in various types to help meet your shield termination needs and termination tool of your choice.

INDUSTRY STANDARD

- Meets VG standards

RELIABLE

- Time tested design has been used in Mil-Spec applications for years
- Corrosion resistant stainless steel

EASY TO USE

- Band straps available flat for side entry or precoiled for end entry
- Side-entry band straps allow easier installation and repair

VERSATILE

- Various strap types
- TE commercial part offering where no VG part number available

VG 95319-1015	DESCRIPTION	TE COMMERCIAL PART NUMBER
A101	2 Step Standard Band Straight	BND-1225-S
—	2 Step Standard Band Pre Coiled	BND-1225-P
A001	1 Step Standard Band Straight	BND-1425-S
—	1 Step Standard Band Pre Coiled	BND-1425-P
A002	1 Step Standard Band Extended - Straight	—
—	1 Step Standard Band Extended - Pre Coiled	—
A102	2 Step Micro Band Straight	BND-1012-S
—	2 Step Micro Band Pre Coiled	BND-1012-P
A003	1 Step Micro Band Straight	BND-0812-S
—	1 Step Micro Band Pre Coiled	BND-0812-P
A004	1 Step Micro Band Extended - Straight	BND-1412-S
—	1 Step Micro Band Extended - Pre Coiled	BND-1412-P
A103	2 Step Micro Band Extended - Straight	BND-1212-S
—	2 Step Micro Band Extended - Pre Coiled	BND-1212-P

NOTE:

• Visit TE.com for cross reference information.

1011A (PVG1A)
1011B (PVG1B)
1011C (PVG1C)
1011D (PVG1D)
1011E (PVG1E)
1011F (PVG1F)
1011G (PVG1G)
1011H (PVG1H)
BAND STRAPS

1011A (PVG1A)
1011B (PVG1B)
1011C (PVG1C)
1011D (PVG1D)
1011E (PVG1E)
1011F (PVG1F)
1011G (PVG1G)
1011H (PVG1H)
BAND STRAPS

VG 96928 - 41,42,43,44 HARTMAN Contactors



Reducing size and weight in aerospace and military ground vehicles can afford the opportunity to add greater capability and extend mission times. HARTMAN K Series contactors from TE offer outstanding performance and reliability in a highly efficient package.

Small Size, Powerful Performance

K Series DC contactors are among the smallest and lightest 200 Amp to 1,000 Amp contactors available in the aerospace industry. These highly flexible bus-bar mounted or chassis-mounted units are designed for either continuous or start duty applications in the DC power distribution systems of commercial and military aircraft, and military ground vehicles.

SPACE AND WEIGHT SAVINGS

- Light weight
- Small package size
- Small footprint

VERSATILE

- Easy to package in panel assemblies
- Not position sensitive; bus bar mount or chassis mount
- Auxiliary contacts available

RUGGED AND POWERFUL

- Rated 200, 400, 500, and 1,000 amps, 28 VDC
- SPST NO, double break
- Designed to the performance standards of MIL-PRF-6106
- 10X rupture current
- Environmentally (gasket) sealed

APPLICATIONS

- Commercial Aerospace
- Military Aerospace
- Military Ground Vehicles

VG 96928 - 41,42,43,44 HARTMAN Contactors

HARTMAN Contactors

- Small
- Light
- Robust
- Flight Approved

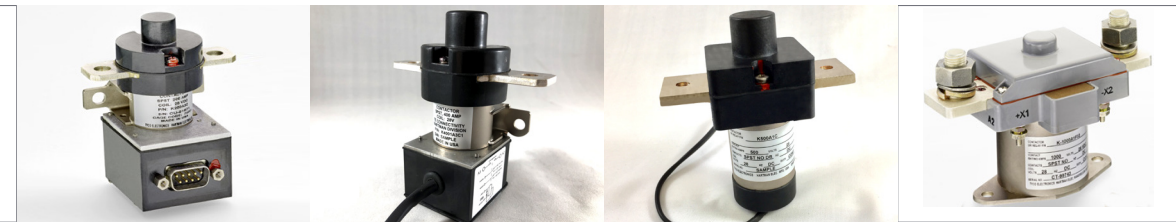

PRODUCT SERIES	K200	K4001	K500	K1000
Contact Configuration	SPST-NO Aux. Optional	SPST-NO Aux. Optional	SPST-NO Aux. Optional	SPST-NO
Contact Rating (Amps)	200A	400A	500A	1,000A
Bi-Directional Switching	Yes	Yes	Yes	Yes
Contact Voltage (Vdc)	24/28	24/28	24/28	28
Weight	150 g (.33 lbs)	230 g (.50 lbs)	320 g (.70 lbs)	1,250 g (2.75 lbs)
Coil Voltage (Vdc)	24/28	24/28	24/28	24/28
Coil Economizer	Yes	Yes	Yes	Yes
Sealing	Gasket	Gasket	Gasket	Gasket
VG Certification	VG 96928-41	VG 96928-42	VG 96928-43	VG 96928-44
Designed to the performance standards of	MIL-PRF-6106	MIL-PRF-6106	MIL-PRF-6106	MIL-PRF-6106
Dielectric withstanding voltage	1050VAC / 1min at 50Hz	1050VAC / 1min at 50Hz	1050VAC / 1min at 50Hz	1050VAC / 1min at 50Hz
Mechanical Life	100,000 cycles	100,000 cycles	100,000 cycles	100,000 cycles
Wire Section	1 - 1 AWG	2 - 1 AWG	2 - 2/0 AWG	3 - 4/0 AWG
TE Part Numbers	K200A1C6 K200A3C2	K4001A1C3 K4001A3C2	K500A1C1 K500A2C1	K1000A1F08

41,42,43,44
(CONTACTORS)

03,04,06,08,21,23
(RELAYS)

41,42,43,44
(CONTACTORS)

03,04,06,08,21,23
(RELAYS)

VG 96928 - 03,04,06,08,21,23 KISSLING Series 26 Relay



TE's KISSLING brand is a well-known supplier of high-performance relays. The Series 26 dual coil relay were developed using our extensive know-how gathered over decades of manufacturing high-end power relays to meet even the most difficult operating requirements. This dual coil system relay features extremely high shock and vibration resistance resulting from careful design and an optimized magnetic circuit for currents up to 1000A.

Dual-coil monostable high-performance relay

The sealing technology used in these relays meets or exceeds both the IP67 and IP6K9K (steam pressure cleaning) protection standard. This series of relays is well suited for various applications in severe conditions on commercial military and aviation vehicles. Other important advantages are low heat generation in the contact area based on low contact voltage drop, a compact design, low holding current, silver alloy contact material and the use of mechanical and high thermal stability insulating compounds. Both the terminals and housing are protected against corrosion. These relays are available with a wide variety of configuration options including contact configurations (NO; NC; NO/NC) and coil voltages (12 V, 24/28 V). Various bracket styles are available to enable solutions for your installation conditions. Also available are optional suppression devices to eliminate electromagnetic interference at the coil and optional auxiliary contacts.

Confirmed to VG Number: VG 96928

Military Specification: MIL-PRF-6106

FEATURES

- Sealed housing conforms to IP6K9K / IP67
- Dual-Coil monostable high-performance relay
- Mechanical life tested for 100,000 mechanical cycles
- 50G shock & 10G vibration resistant
- Military grade performance
- Meets the requirements of MIL-PRF-6106
- VG 96928 approval

APPLICATIONS

- Commercial Transportation
- Military Ground Vehicles
- Power Distribution

VG 96928 - 03,04,06,08,21,23 KISSLING Series 26 Relay

KISSLING Series 26							
PRODUCT SERIES	50A	100A	200A	300A	300A Light Weight	500A	1000A
Mechanical Life	200.000 cycles - 12A	100.000 cycles - 25A	100.000 cycles - 50A	100.000 cycles - 75A	100.000 cycles - 75A	100.000 cycles - 125A	100.000 cycles - 250A
Protection	IP6K9K / IP67	IP6K9K / IP67	IP6K9K / IP67	IP6K9K / IP67	IP6K9K / IP67	IP6K9K / IP67	IP6K9K / IP67
Shock	10G - 6msec / 500G - 0,5msec	30G - 11msec	30G - 11msec	30G - 11msec	30G - 11msec	30G - 11msec	30G - 11msec
Acceleration	15G	15G	15G	15G	15G	15G	15G
Wire Section	min 6mm ² / AWG 9	min. 25mm ² / AWG 3	min. 70mm ² / AWG 3	min. 95mm ² / AWG 0000	min. 95mm ² / AWG 0000	min. 240mm ² / MCM 500	min. 500mm ² / MCM 1000
Continuous current (Amps)	50A	100A	200A	300A	300A	500A	1000A
Dielectric withstanding voltage	1050VAC / 1min at 50Hz	1050VAC / 1min at 50Hz	1050VAC / 1min at 50Hz	1050VAC / 1min at 50Hz	1050VAC / 1min at 50Hz	1050VAC / 1min at 50Hz	1050VAC / 1min at 50Hz
Rupture current (Amps)	500A	1000A	2000A	3000A	3000A	5000A	10.000A
Voltage range (VDC)	10-15 VDC 18-32 VDC	10-15 VDC 18-32 VDC	10-15 VDC 18-32 VDC	10-15 VDC 18-32 VDC	10-15 VDC 18-32 VDC	10-15 VDC 18-32 VDC	18-32 VDC
Nominal voltage (VDC)	12 VDC 24/28 VDC	12 VDC 24/28 VDC	12 VDC 24/28 VDC	12 VDC 24/28 VDC	12 VDC 24/28 VDC	12 VDC 24/28 VDC	24/28 VDC
Confirmed to VG number	VG 96928-03	VG 96928-04	VG 96928-21	VG96928-06	VG 96928-06	VG 96928-23	VG 96928-08
MIL SPEC	MIL-PRF-6106	MIL-PRF-6106	MIL-PRF-6106	MIL-PRF-6106	MIL-PRF-6106	MIL-PRF-6106	MIL-PRF-6106

VG 96935-6 CII Low Signal Relays

CII LOW SIGNAL (RELAYS)

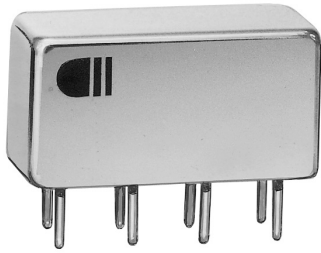

CII relays from TE provide enhanced switching and electrical specifications for demanding environments. The high-performance relays are engineered to perform reliably in commercial, nuclear, harsh aerospace and military applications. CII relays are available in many mounting and terminal configurations to fit your specific application.

FEATURES

- DPDT contact configuration
- Hermetically sealed enclosures
- Up to 2 amps switching
- High shock & vibration ratings
- Choices of mounting and terminal styles

APPLICATIONS

- Instrumentation controls
- Navigation and communication
- Load switching

CII low-signal electromechanical relays

CII relays offer critical size and weight savings in demanding applications by providing efficient power switching in a compact package. Our balanced force design provides the benefit of consistently high contact pressure, reduced bounce, and less arching leading to extended contact life.

Confirmed to VG Number: VG 96935-6

Military Specification: MIL-PRF-39016/6

CONTACT RATINGS

Contact Load	Type	Operations (min.)
2 A @ 28V DC	Resistive	100,000
0.75 A @ 28V DC 100,000	Inductive (200mH)	100,000
0.1 A @ 115V AC, 60 Hz & 400 Hz	Resistive	100,000
0.3 A @ 115V AC, 60 Hz & 400 Hz	Hz Resistive	100,000
0.1 A @ 28V DC	Intermediate	50,000
0.160 A @ 28V DC	Lamp	100,000
30 µA @ 50 mV DC	Low Level	1,000,000

RF PERFORMANCE

Frequency	RF Losses (dB)	VSWR	Isolation (dB)
100	0.1	1.17:1	40
500	0.3	1.19:1	28
1000	0.4	1.19:1	23

VG 95318 - 11 KISSLING Toggle Switch



KISSLING toggle switches are sealed themselves and offer additional sealing rings for improved mounting solutions and optional bellows for the handles.

Quality Switch Series 08/09

This series of toggle switches is mainly used as robust, industrial and durable switches in military vehicles. The housing of the Series 08 and 09 is made of duroplastic and meets IP68/IP6K8 protection class standards.

This toggle switch is equipped with a safe switching mechanism, which is provided by an additional internal contact protection. Our broad selection of toggles includes many options for switching configuration, termination type, load carrying capabilities and locking combinations.

Confirmed to VG Number: VG 95318-11

FEATURES

- Military grade robustness VG 95318-11
- High quality silver alloy or gold-plated contacts
- Sealing technology meets IP68/IP6K8
- 2- and 3-Position switch actions
- Variety of available switching styles
- Locking options for individual needs

APPLICATIONS

- Commercial vehicles
- Aviation ground support equipment
- Military ground equipment
- Military vehicles
- Plant and industrial engineering
- Medical equipment
- Construction machinery

SPECIFICATIONS

Technical Data	
Housing material	Duroplast GF
Construction i.a.w.	VG 95 318 and IEC 1 020
Seal connection	IP68 IEC 60529 / IP6K8 DIN 40050 part 9 / IP6K8 ISO 20653 IP00 IEC 60529 / IP00 DIN 40050 part 9 / IP00 ISO 20653
Current carrying parts	CuZn-alloy
Contact material	Silver-alloy or gold plated contacts
Temperature range	-55°C to +85°C
Electrical life (nominal load)	100,000 cycles
Nominal volatge / Continuous current	28VDC, 20A ohmic load 28VDC, 15A L/R = 5msec inductive load 115VAC, 15A inductive load
Min. switching capacity	12VDC, 20mA

TOGGLE (SWITCH)

BLACKOUT (SWITCH)

VG 95318 - 14 KISSLING Blackout Light Switch



KISSLING Blackout light switch features error free and safe switching with additional infrared lighting function.

This switch combines two switching systems in one, it switches on one side the normal road light and on the other side the infrared lighting function.

FEATURES

- Developed for various military applications
- Meets the standards of the military - NATO STOCK NUMBER 5930-12-397-5914
- Error free switching plus additional infrared lighting function
- Safe and risk-free switching
- Smallest possible switch size with easy-to-use and safe handling

APPLICATIONS

- Civil and military aviation
- Civil commercial vehicles
- Military ground equipment and vehicles
- Marine applications
- Mechanical and plant engineering

Mission-Critical Safety and Reliability

Smaller, lighter components and systems require more bandwidth to meet increasingly complex security requirements and the need for greater functionality. All products must be rugged enough to withstand the demanding requirements of military ground, air, and sea applications.

TE has been and continues to be a valuable partner in the development of more robust switching components - all critical factors in closing safety gaps and ensuring the reliability and success of the next generation of military vehicles.

Confirmed to VG Number: VG 95318-14

Military Specification: MIL-PRF-6106

SPECIFICATIONS

Technical Data	
Protection class (switch interior)	IP54 / ISO 20653
Protection class (connector)	IP00 / ISO 20653
Temperature range	-46°C to +85°C
Voltage range	3 - 32 VDC
Rate load	6 (8) A
Minimum load	0,3 mA / 3 VDC
Shock	300m/s ² , 11ms half-sine
Vibration	100m/s ² at 10 Hz to 2000Hz

VG 95210 - KISSLING Limit Switch - Series G12



Limit switches have been designed to detect the presence or lack of presence of an object. A limit switch is an electromechanical device operated by a physical force applied to it by an object.

Specific shock and vibration levels

The G12 series originally developed for aerospace and commercial vehicles can also be integrated in many vehicles, which need to fulfill specific shock and vibration related requirements.

Based on its compact design, the different actuators and the variety of connection types, the KISSLING G12 limit switch can be integrated in difficult positions and under extreme environmental conditions to ensure dependability.

The KISSLING G12 limit switch complies i.a. with VG 95210 for shock and vibration and meets MIL-S-8805 many of our G12 limit switch are also NSN (NATO Stock Number) listed.

SPECIFICATIONS

Technical Data	
Housing material	Stainless steel
Temperature range	-55°C to +85°C
Protection (does not include spliced cable end)	IEC 60529, IP67 (0,2 bar, 5min)
Vibration i.a.w. MIL-STD-202	15g
Shock i.a.w. MIL-STD-202	100g
max. approach speed at an angle of <30°	
Ball, Chisel	5m/min
Roller	30m/min
Operating force	30 3 5 N
Endurance	
i.a.w. MIL-S-8805; \$4.8.26 (28 VDC; 1 Amps)	100.000 cycles
i.a.w. MIL-S-8805; \$4.8.26 (28 VDC; 5 Amps) only silver contacts	25.000 cycles

All switches will be delivered with 2 hex nuts, 1 lockwasher and 1 keyway washer

SWITCH INSERTS

Type	MS 24547-1 / silver		MS 24547-2 / gold	
	up to +82°C		up to +82°C	
i.a.w. MIL-S-8805	max.	min.	max.	min.
Electrical rating	28VDC, 7A	15VDC, 10mA	28VDC, 0.4A	15VDC, 5mA
Resistance load	28VDC, 7A	5VDC, 20mA	28VDC, 0.2A	5VDC, 10mA
Inductive load	28VDC, 7A	5VDC, 20mA	28VDC, 0.2A	5VDC, 10mA

VG 95210 - KISSLING Limit Switch - Series G13



FEATURES

- Military grade switch (VG 95210; MIL-S-8805)
- 1- & 2-pole versions
- Available with silver or gold contacts
- Shock (100G) and vibration (15G)
- Different actuator options available
- Aluminum housing; special versions with resistance to salt and seawater

APPLICATIONS

- Commercial and military motor vehicles
- Military ground equipment and vehicles
- Marine applications
- Aviation ground support vehicles

Environmentally sealed G13 limit switches can be integrated in many vehicles, which need to fulfill specific shock and vibration related requirements.

Switch meets specific shock and vibration levels

The KISSLING G13 limit switches meet high requirements for function and reliability under extreme conditions and become a valuable electric component in every vehicle application to ensure dependability.

The G13 limit switch complies i.a. with VG 95210 for shock and vibration and meets MIL-S-8805. Many of our G13 limit switches are also NSN (NATO Stock Number) listed.

Similar to emergency-stop function

Switches with locking mechanisms are manually operated switches with two switching positions. The change-over from switching position 1 to switching position 2 occurs whenever the actuation knob has been firmly pressed down.

The switch remains locked in switching position 2. Twisting the actuation knob in the direction of the arrow will release the locking mechanism and the switch will snap back into switching position 1.

SPECIFICATIONS

Technical Data

Housing Material Special type	Al-alloy salt- and seawater resistance
Temperature range Special type	-55°C to +85°C -55°C to +125°C
Protection (connected)	IEC 60529, IP67 (0,2 bar, 5min)
Vibration i.a.w. MIL-STD-202	15g
Shock i.a.w. MIL-STD-202	100g
max. approach speed at an angle of <30°	
Ball, Chisel	5m/min
Roller	30m/min
Operating force without looking	15 or 30 3 5 N
Endurance	
i.a.w. MIL-S-8805; §4.8.26 (28 VDC; 1 Amps)	100.000 cycles
i.a.w. MIL-S-8805; §4.8.26 (28 VDC; 5 Amps) only silver contacts	25.000 cycles

SWITCH INSERTS

Type	MS 24547-1 / silver		MS 24547-2 / gold	
	up to +82°C		up to +82°C	
i.a.w. MIL-S-8805	max.	min.	max.	min.
Electrical rating	28VDC, 7A	15VDC, 10mA	28VDC, 0.4A	15VDC, 5mA
Resistance load	28VDC, 7A	5VDC, 20mA	28VDC, 0.2A	5VDC, 10mA
Inductive load				

VG 96927-2 Integrated Military Harness Systems



Assembled Military Harness



Military Harness System Components

Nothing is more important on or off the battlefield than reliable systems. With decades of experience in supporting military readiness, we are helping ground defense & marine achieve a decisive edge in capabilities, reliability, and mission readiness.

Rugged Sealed Cable Assemblies

Integrated harnesses provide ready-to-install solutions that mean reliability in the toughest application environments. Every assembly meets your requirements for sealing, moisture and chemical resistance, shielding, strain relief, flexibility, and ease of use.

TE's integrated harness systems have been developed for a wide range of defense applications. Each system consists of compatible components, including cable jackets, heat-shrinkable components, and adhesives (see photo at left).

A typical designed harness consists of seven component parts (pictured below):

VERSATILE

- Using a wide range of approved VG components
- Components available in various material systems
- Fully customizable VG compliant harness assembly

RUGGED

- TE ruggedized assemblies bring benefits to challenging environments and applications
- Selecting the right component for shielding, strain relief, flexibility and for ease of use

ADAPTABLE

- Specialty adhesives and sealants for complete environmental sealing*

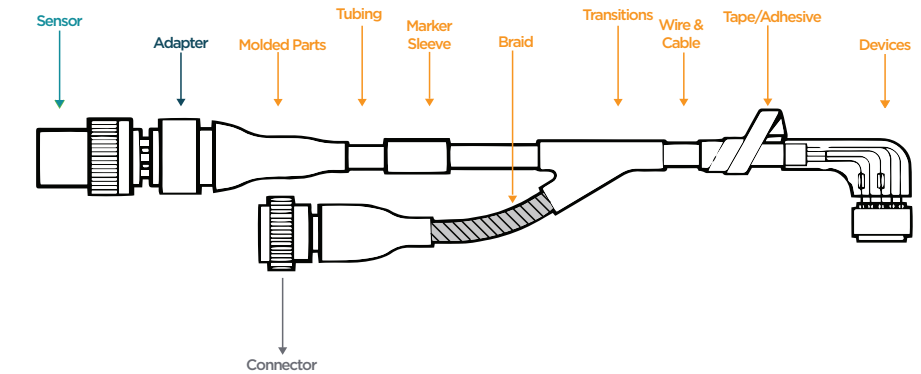

1. Wire and Cable (Customized machine-build EPDs and hand-lay wire and cables)
2. Heat-Shrinkable Tubing
3. Backshell Adapter
4. Molded Part
5. Adhesive
6. Cable Jacket
7. Marker Sleeve**

*TE Sealant product information available at www.te.com

**TE Identification products information available at www.te.com

VG 96927-2 Integrated Military Harness Systems



Components	System 25 - Diesel Resistant	System 100 - Zerohal
Wire	VG 95218 T020 A & G VG 95218 T021 B & E VG 95218 T022 B & C VG 95218 T023 B & F VG 95218 T024 K VG 95218 T025 G	VG 95218 T020 E VG 95218 T021 C VG 95218 T022 D VG 95218 T023 C & G
Tubing	VG 95343 T05 D	VG 95343 T05 L
Braid	VG 96936 T10 A & B	VG 96936 T10 A & B
Molded Parts	VG 95343 T06 A, B, E, K & L VG 95343 T07 A, B, C, D, E & F VG 95343 T08 A, B, C, D & E VG 95343 T09 A, B & C VG 95343 T18 A, B, C, D, E, F, G & H VG 95343 T19 A, B, C, D, E, F & G VG 95343 T25 A & B	VG 95343 T29 A, B, C & D VG 95343 T30 A, B, C & D
Adhesive	VG 95343 T15 D	VG 95343 T15 D

Harness Construction Process

Selecting the components for a harnessing system is a four-step process:

Step 1: Select the material system appropriate for the operating conditions and environment to which the harness will be exposed.

Step 2: Select the adhesive system appropriate for the material system you select in Step 1.

Step 3: Determine the level of EMI shielding required.

Step 4: Select the components.

Select the Material System

Above table shows material systems for use in a wide range of operating conditions and environments.

Additional information can also be seen on page 6/7 of this brochure.

Choose a material system that:

- Has the physical characteristics your harness requires.
- Will accommodate the operating temperature and the fluids intense physical conditions to which the harness will be exposed.

TE is a source for VG harness solutions for defense applications. From a single system to full vehicle support, TE can engineer to your strictest requirements. A demanding environment requires first class integration and support. TE is your world-class partner starting from the design stage and carrying through to application execution.



Abbreviations



Abbreviation	Definitions
AWG	American Wire Gauge
BAAINBw	Bundesamt für Ausrüstung, Informationstechnik und Nutzung der Bundeswehr (Federal Office of Bundeswehr Equipment, Information Technology and In-Service Support)
DIN	Deutsches Institut für Normung (German Institute for Standardization)
EMC	Electromagnetic Compatibility
EMI	Electromagnetic Interference
ETFE	Ethylene Tetrafluoroethylene
IEC	International Electrotechnical Commission (Standard Organization)
IED	Improvised Explosive Device
LFH	Low Fire Hazard
MRO	Maintenance, Repair and Overhaul
MTV	Militärische Typenvorschrift (Military Type Specification)
NATO	North Atlantic Treaty Organization
NSN	Nato Stock Number
NBC	Nuclear Biological Chemical
PVDF	Polyvinylidene Fluoride
RFI	Radio Frequency Interference
RoHS	Restriction of (the use of certain) Hazardous Substances in Electrical and Electronic Equipment
TW	Thin Wall
VDE	Verband der Elektrotechnik (Electrical Engineering Association)
VG	Verteidigungsgerätenorm (Defence Equipment Standard)

Empower Engineers to Solve Problems, Moving the World Forward.

AMP | AGASTAT | CII | DEUTSCH | DRI | HARTMAN | KILOVAC
MICRODOT | NANONICS | POLAMCO | Raychem | SEACON

Connect With Us

We make it easy to connect with our experts and are ready to provide all the support you need. Visit te.com/support to chat with a Product Information Specialist.

te.com/vg-standards

AMP, AGASTAT, CII, DEUTSCH, DRI, SolderTacts, KISSLING, Zerohal, HARTMAN, RayBraid, KILOVAC, MICRODOT, NANONICS, POLAMCO, Raychem, SEACON, TE, TE Connectivity, TE connectivity (logo) and Every Connection Counts are trademarks. All other logos, products and/or company names referred to herein might be trademarks of their respective owners.

The information given herein, including drawings, illustrations and schematics which are intended for illustration purposes only, is believed to be reliable. However, TE Connectivity makes no warranties as to its accuracy or completeness and disclaims any liability in connection with its use. TE Connectivity's obligations shall only be as set forth in TE Connectivity's Standard Terms and Conditions of Sale for this product and in no case will TE Connectivity be liable for any incidental, indirect or consequential damages arising out of the sale, resale, use or misuse of the product. Users of TE Connectivity products should make their own evaluation to determine the suitability of each such product for the specific application.

© 2023 TE Connectivity Ltd. family of companies All Rights Reserved.

2392785-1 10/23 Original

SOLUTIONS FOR DEFENSE APPLICATIONS CERTIFIED TO VG STANDARDS

TE Connectivity

Aerospace, Defense & Marine
2900 Fulling Mill Road
Middletown, PA 17057