

ON Semiconductor

Is Now

onsemi™

To learn more about onsemi™, please visit our website at
www.onsemi.com

onsemi and **onsemi** and other names, marks, and brands are registered and/or common law trademarks of Semiconductor Components Industries, LLC dba "**onsemi**" or its affiliates and/or subsidiaries in the United States and/or other countries. **onsemi** owns the rights to a number of patents, trademarks, copyrights, trade secrets, and other intellectual property. A listing of **onsemi** product/patent coverage may be accessed at www.onsemi.com/site/pdf/Patent-Marking.pdf. **onsemi** reserves the right to make changes at any time to any products or information herein, without notice. The information herein is provided "as-is" and **onsemi** makes no warranty, representation or guarantee regarding the accuracy of the information, product features, availability, functionality, or suitability of its products for any particular purpose, nor does **onsemi** assume any liability arising out of the application or use of any product or circuit, and specifically disclaims any and all liability, including without limitation special, consequential or incidental damages. Buyer is responsible for its products and applications using **onsemi** products, including compliance with all laws, regulations and safety requirements or standards, regardless of any support or applications information provided by **onsemi**. "Typical" parameters which may be provided in **onsemi** data sheets and/or specifications can and do vary in different applications and actual performance may vary over time. All operating parameters, including "Typicals" must be validated for each customer application by customer's technical experts. **onsemi** does not convey any license under any of its intellectual property rights nor the rights of others. **onsemi** products are not designed, intended, or authorized for use as a critical component in life support systems or any FDA Class 3 medical devices or medical devices with a same or similar classification in a foreign jurisdiction or any devices intended for implantation in the human body. Should Buyer purchase or use **onsemi** products for any such unintended or unauthorized application, Buyer shall indemnify and hold **onsemi** and its officers, employees, subsidiaries, affiliates, and distributors harmless against all claims, costs, damages, and expenses, and reasonable attorney fees arising out of, directly or indirectly, any claim of personal injury or death associated with such unintended or unauthorized use, even if such claim alleges that **onsemi** was negligent regarding the design or manufacture of the part. **onsemi** is an Equal Opportunity/Affirmative Action Employer. This literature is subject to all applicable copyright laws and is not for resale in any manner. Other names and brands may be claimed as the property of others.



ON Semiconductor®

FPF2290 Over-Voltage Protection Load Switch

Features

- Surge Protection
 - IEC 61000-4-5: ±100 V
- Selectable Over-Voltage Protection (OVP) with OV1 and OV2 Logic inputs
 - 5.9 V ±100 mV
 - 10 V ±100 mV
 - 14 V ±280 mV
 - 23 V ±460 mV
- Over-Temperature Protection (OTP)
- Ultra-Low On-Resistance: Typ. 33 mΩ
- ESD Protection
 - Human Body Model (HBM): > 2 kV
 - Charged Device Model (CDM): > 1 kV
 - IEC 61000-4-2 Air Discharge: > 15 kV

Description

The FPF2290 features a low- R_{ON} internal FET and an operating voltage range of 2.5 V to 23 V. An internal clamping circuit is capable of shunting surge voltages of ±100 V, protecting downstream components and enhancing system robustness. The FPF2290 features over-voltage protection that powers down the internal FET if the input voltage exceeds the OVP threshold. The OVP threshold is selectable via Logic select pins (OV1 and OV2). Over-temperature protection also powers down the device at 130°C (typical).

The FPF2290 is available in a fully “green” compliant 1.3 mm × 1.8 mm Wafer-Level Chip-Scale Package (WLCSP) with backside laminate.

Applications

- Mobile Handsets and Tablets
- Portable Media Players
- MP3 Players

Ordering Information

Part Number	Operating Temperature Range	Top Mark	Package	Packing Method
FPF2290BUCX-F130	-40°C – +85°C	HR	12-Ball, 0.4 mm Pitch WLCSP	Tape & Reel

Block Diagram

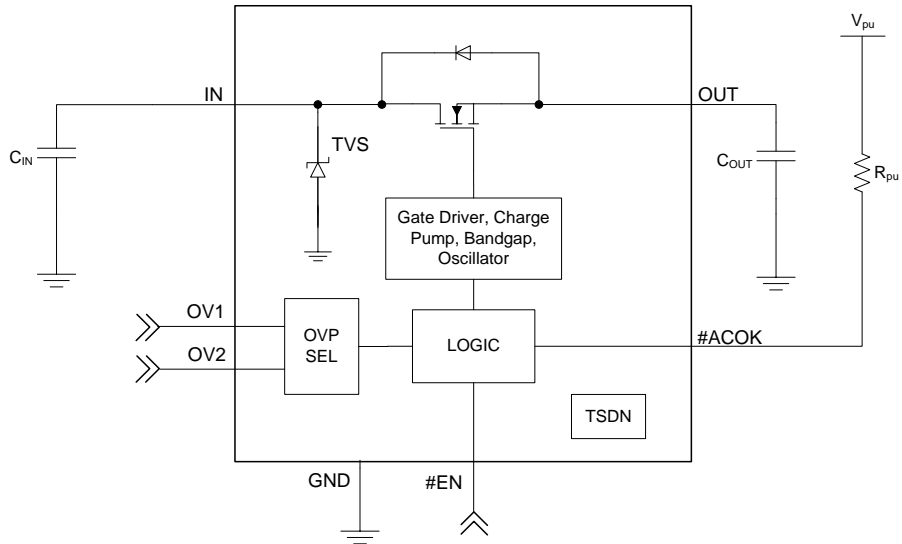

Figure 1. Functional Block Diagram

Note:

1. Setting OV1 and OV2 logic level are recommended before IN is applied.

Pin Configuration

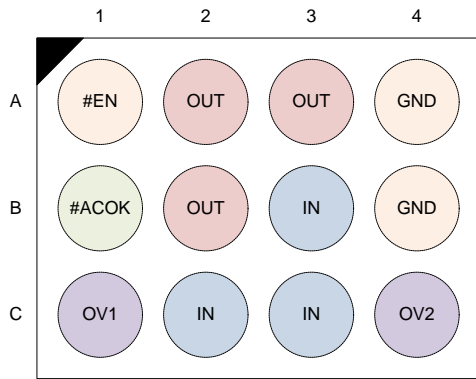
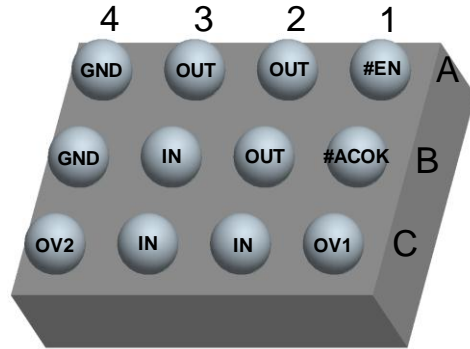
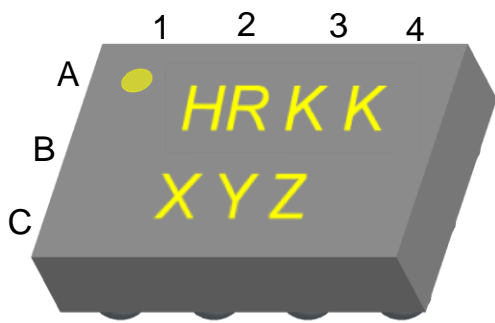

Figure 2. Pin Configuration (Top View)

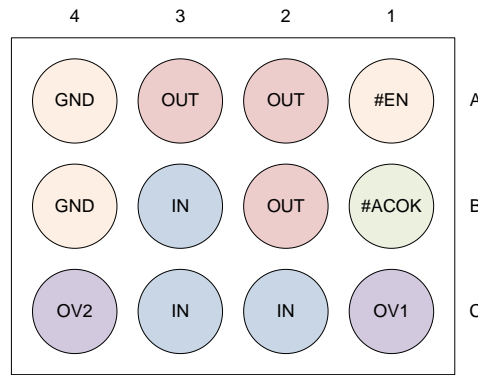

Figure 3. Pin Configuration (Bottom View)

Pin Definitions

Name	Bump	Type	Description	
IN	B3, C2, C3	Input/Supply	Switch Input and Device Supply	
OUT	A2, A3, B2	Output	Switch Output to Load	
#ACOK	B1	Output	1	Hi-Z: $V_{IN} < V_{IN_MIN}$ OR $V_{IN} > V_{OVLO}$
			0	LOW: Voltage Stable
#EN	A1	Input	Device Enable (Active LOW)	
OV1/2	C1, C4	Input	OVLO Selection Input (see Table 1) Note: Apply OV1 and OV2 Logic levels before V_{IN} is applied.	
GND	A4, B4	Supply	Device Ground	

Table 1. OVLO Selection

OV1	OV2	OVLO Trip Level
LOW	LOW	5.9 V \pm 100 mV
HIGH	LOW	10 V \pm 100 mV
LOW	HIGH	14 V \pm 280 mV
HIGH	HIGH	23 V \pm 460 mV

Absolute Maximum Ratings

Stresses exceeding the absolute maximum ratings may damage the device. The device may not function or be operable above the recommended operating conditions and stressing the parts to these levels is not recommended. In addition, extended exposure to stresses above the recommended operating conditions may affect device reliability. The absolute maximum ratings are stress ratings only.

Symbol	Parameter	Min.	Max.	Unit
V _{IN}	V _{IN} to GND & V _{IN} to V _{OUT} = GND or Float	-0.3	29.0	V
V _{OUT}	V _{OUT} to GND	-0.3	V _{IN} + 0.3	V
V _{OVn}	OV1 and OV2 to GND	-0.3	6.0	V
V _{EN_ACOK}	Maximum DC Voltage Allowed on #EN or #ACOK Pin		6	V
I _{IN}	Switch I/O Current (Continuous)		4.5	A
t _{PD}	Total Power Dissipation at T _A = 25°C		1.48	W
T _{STG}	Storage Temperature Range	-65	+150	°C
T _J	Maximum Junction Temperature		+150	°C
T _L	Lead Temperature (Soldering, 10 Seconds)		+260	°C
θ _{JA}	Thermal Resistance, Junction-to-Ambient ²⁾ (1-in. ² Pad of 2-oz. Copper)		84.1	°C/W
ESD	IEC 61000-4-2 System Level ESD	Air Discharge	15	kV
		Contact Discharge	8	
	Human Body Model, ANSI/ESDA/JEDEC JS-001-2012	All Pins	2	
	Charged Device Model, JESD22-C101	All Pins	1	
Surge	IEC 61000-4-5, Surge Protection	V _{IN}	±100	V

Note:

2. Measured using 2S2P JEDEC std. PCB.

Recommended Operating Conditions

The Recommended Operating Conditions table defines the conditions for actual device operation. Recommended operating conditions are specified to ensure optimal performance to the datasheet specifications. ON Semiconductor does not recommend exceeding them or designing to Absolute Maximum Ratings.

Symbol	Parameter	Min.	Max.	Unit
V _{IN}	Supply Voltage	2.5	23.0	V
T _A	Operating Temperature	-40	+85	°C

Electrical Characteristics

$T_A = -40^\circ\text{C}$ to 85°C , $V_{IN} = 2.5$ to 23 V, unless otherwise indicated. Typical values are $V_{IN} = 5.0$ V, $I_{IN} \leq 3$ A, $C_{IN} = 0.1$ μF and $T_A = 25^\circ\text{C}$.

Symbol	Parameter	Conditions	Min.	Typ.	Max.	Unit	
Basic Operation							
V_{IN_CLAMP}	Input Clamping Voltage	$I_{IN} = 10$ mA		35		V	
I_Q	Input Quiescent Current	$V_{IN} = 5$ V, #EN = 0 V		80	115	μA	
I_{IN_Q}	OVLO Supply Current	OV1 = LOW, OV2 = LOW $V_{IN} = 6.5$ V, $V_{OUT} = 0$ V		63	90	μA	
V_{IN_OVLO}	Over-Voltage Trip Level	V_{IN} Rising	OV1 = LOW, OV2 = LOW	5.80	5.90	6.00	V
		V_{IN} Falling		5.75			
		V_{IN} Rising	OV1 = HIGH, OV2 = LOW	9.90	10.00	10.10	
		V_{IN} Falling		9.85			
		V_{IN} Rising	OV1 = LOW, OV2 = HIGH	13.72	14.0	14.28	
		V_{IN} Falling		13.52			
		V_{IN} Rising	OV1 = HIGH, OV2 = HIGH	22.54	23.0	23.46	
V_{IN} Falling	22.34						
R_{ON}	Resistance from V_{IN} to V_{OUT}	$V_{IN} = 5$ V, $I_{OUT} = 1$ A, $T_A = 25^\circ\text{C}$		33	40	m Ω	
C_{OUT}	OUT Load Capacitance ⁽³⁾	$V_{IN} = 5$ V	0.1		1000.0	μF	
T_{SDN}	Thermal Shutdown n ⁽³⁾			130		$^\circ\text{C}$	
T_{SDN_HYS}	Thermal Shutdown n Hysteresis ⁽³⁾			20		$^\circ\text{C}$	
Digital Signals							
V_{OL}	#ACOK Output Low Voltage	$I_{SINK} = 1$ mA			0.4	V	
I_{ACOK}	#ACOK Leakage Current	$V_{I/O} = 3.0$ V, #ACOK Deasserted			0.5	μA	
V_{IH}	Input HIGH Voltage (#EN, OVx)	$V_{IN} = 2.5$ V to V_{OVLO}	1.2			V	
V_{IL}	Input LOW Voltage (#EN, OVx)	$V_{IN} = 2.5$ V to V_{OVLO}			0.5	V	
I_{IN}	Input Leakage Current (#EN, OVx)	$V_{IN} = 5.0$ V, $V_{OUT} = \text{Float}$			1.0	μA	
Timing Characteristics							
t_{DEB}	Debounce Time	Time from 2.5 V < $V_{IN} < V_{IN_OVLO}$ to $V_{OUT} = 0.1 \times V_{IN}$	10	15	20	ms	
t_{START}	Soft-Start Time	Time from $V_{IN} = V_{IN_min}$ to $0.2 \times \#ACOK$, $V_{I/O} = 1.8$ V with 10 k Ω Pull-up Resistor	20	30	40	ms	
t_{ON}	Switch Turn-On Time	$R_L = 100$ Ω , $C_L = 22$ μF , V_{OUT} from $0.1 \times V_{IN}$ to $0.9 \times V_{IN}$	1	3	5	ms	
t_{OFF}	Switch Turn-Off Time ⁽³⁾	$R_L = 100$ Ω , $C_L = 0$ μF , $V_{IN} > V_{OVLO}$ to $V_{OUT} = 0.8 \times V_{IN}$			150	ns	

Note:

- Guaranteed by characterization and design.

Timing Diagrams

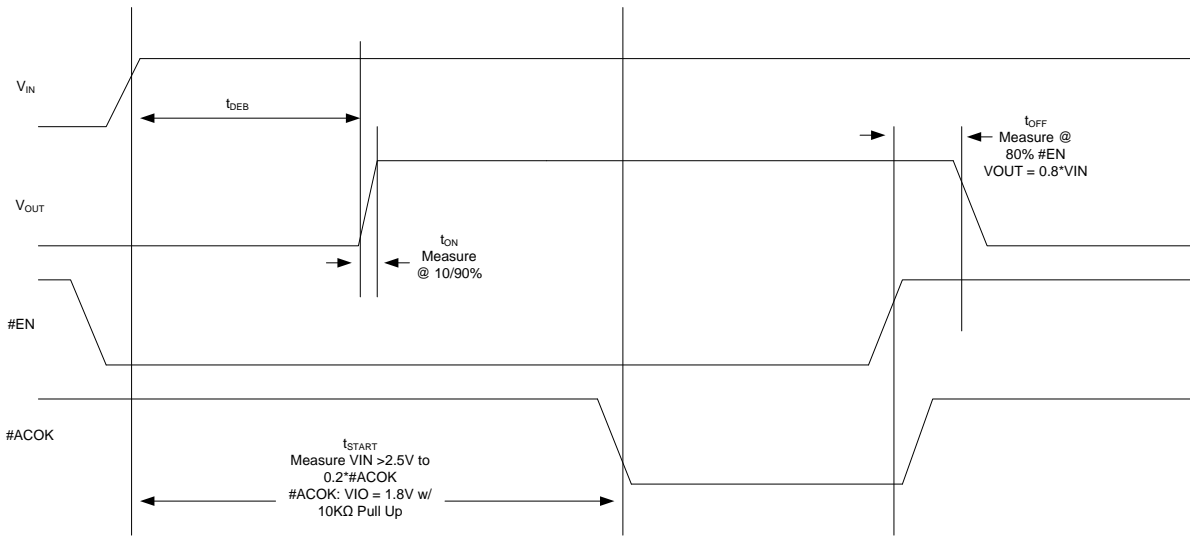

Figure 4. Timing for Power Up and Normal Operation

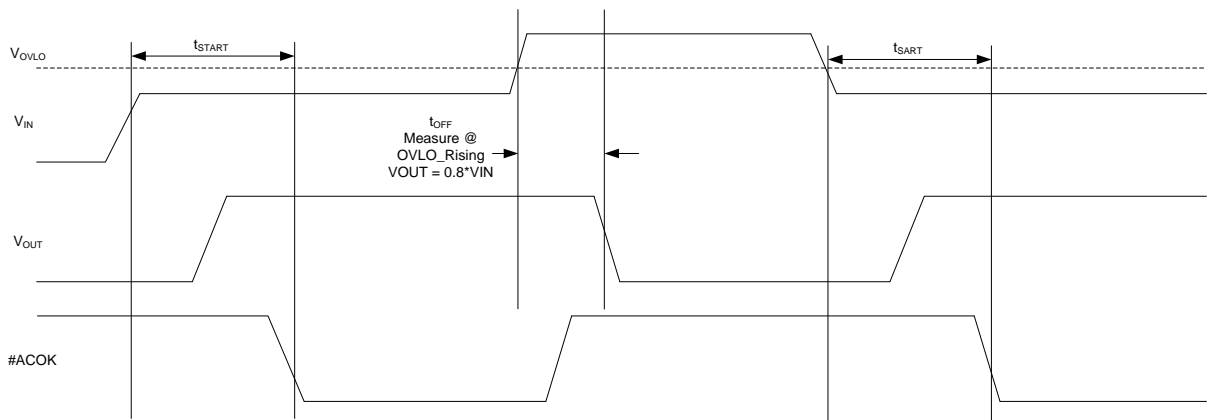
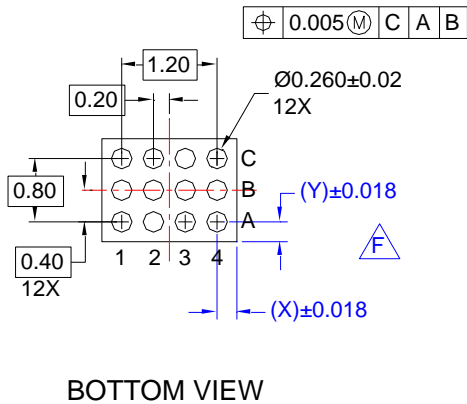
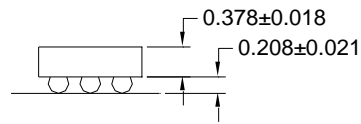
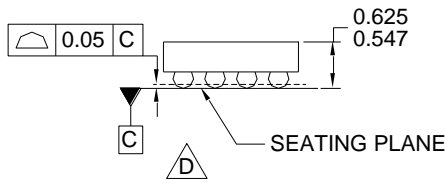
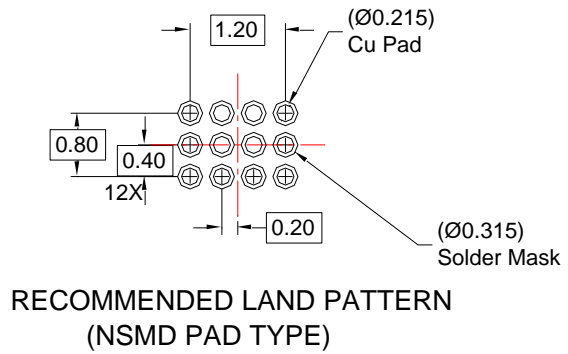
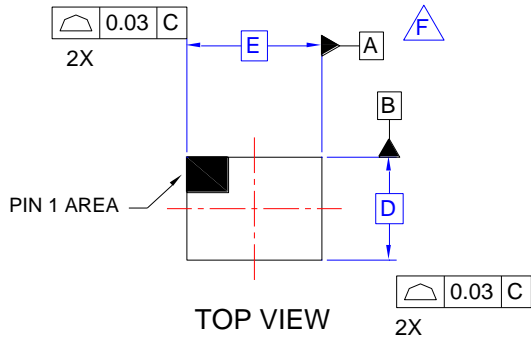

Figure 5. Timing for OVLO Trip

Product-Specific Dimensions

D	E	X	Y
1288 μm ±30 μm	1828 μm ±30 μm	314 μm ±18 μm	244 μm ±18 μm

Physical Dimensions



NOTES:

- A. NO JEDEC REGISTRATION APPLIES.
- B. DIMENSIONS ARE IN MILLIMETERS.
- C. DIMENSIONS AND TOLERANCES PER ASME Y14.5M, 2009.
- D. DATUM C IS DEFINED BY THE SPHERICAL CROWNS OF THE BALLS.
- E. PACKAGE NOMINAL HEIGHT IS 586 MICRONS ±39 MICRONS (547-625 MICRONS).
- F. FOR DIMENSIONS D, E, X, AND Y SEE PRODUCT DATASHEET.
- G. DRAWING FILENAME: MKT-UC012ZCrev2.
- H. ON SEMICONDUCTOR RECOMMENDS THAT LANDS IN THE LANDPATTERN ARE AT LEAST .215MM DIAMETER AS MEASURED AT THE BOTTOM OF THE LAND, NOT THE TOP EDGE.

Figure 6. 12-Ball, 3x4 Array, 0.4 mm Pitch, Wafer-Level Chip-Scale Package (WL CSP)

ON Semiconductor and the ON Semiconductor logo are trademarks of Semiconductor Components Industries, LLC dba ON Semiconductor or its subsidiaries in the United States and/or other countries. ON Semiconductor owns the rights to a number of patents, trademarks, copyrights, trade secrets, and other intellectual property. A listing of ON Semiconductor's product/patent coverage may be accessed at www.onsemi.com/site/pdf/Patent-Marking.pdf. ON Semiconductor reserves the right to make changes without further notice to any products herein. ON Semiconductor makes no warranty, representation or guarantee regarding the suitability of its products for any particular purpose, nor does ON Semiconductor assume any liability arising out of the application or use of any product or circuit, and specifically disclaims any and all liability, including without limitation special, consequential or incidental damages. Buyer is responsible for its products and applications using ON Semiconductor products, including compliance with all laws, regulations and safety requirements or standards, regardless of any support or applications information provided by ON Semiconductor. "Typical" parameters which may be provided in ON Semiconductor data sheets and/or specifications can and do vary in different applications and actual performance may vary over time. All operating parameters, including "Typicals" must be validated for each customer application by customer's technical experts. ON Semiconductor does not convey any license under its patent rights nor the rights of others. ON Semiconductor products are not designed, intended, or authorized for use as a critical component in life support systems or any FDA Class 3 medical devices or medical devices with a same or similar classification in a foreign jurisdiction or any devices intended for implantation in the human body. Should Buyer purchase or use ON Semiconductor products for any such unintended or unauthorized application, Buyer shall indemnify and hold ON Semiconductor and its officers, employees, subsidiaries, affiliates, and distributors harmless against all claims, costs, damages, and expenses, and reasonable attorney fees arising out of, directly or indirectly, any claim of personal injury or death associated with such unintended or unauthorized use, even if such claim alleges that ON Semiconductor was negligent regarding the design or manufacture of the part. ON Semiconductor is an Equal Opportunity/Affirmative Action Employer. This literature is subject to all applicable copyright laws and is not for resale in any manner.

PUBLICATION ORDERING INFORMATION

LITERATURE FULFILLMENT:

Literature Distribution Center for ON Semiconductor
 19521 E. 32nd Pkwy, Aurora, Colorado 80011 USA
Phone: 303-675-2175 or 800-344-3860 Toll Free USA/Canada
Fax: 303-675-2176 or 800-344-3867 Toll Free USA/Canada
Email: orderlit@onsemi.com

N. American Technical Support: 800-282-9855 Toll Free
 USA/Canada.
Europe, Middle East and Africa Technical Support:
 Phone: 421 33 790 2910
Japan Customer Focus Center
 Phone: 81-3-5817-1050

ON Semiconductor Website: www.onsemi.com
Order Literature: <http://www.onsemi.com/orderlit>

For additional information, please contact your local Sales Representative