

1. Application

This specification shall be applied to the TVS Diode.

LXES03TBB1-141
LXES03TAA1-142
LXES02TAA1-144
LXES02TAA1-145
LXES1UTAA1-157
LXES1UTBB1-157
LXES03TAA1-199



2. Part Number Configuration

(e.g.) LXES 1U T AA 1 - 157
① ② ③ ④ ⑤ ⑥

- ① Product ID (LXES = TVS Diode)
- ② Dimension Code

Unit : mm

Code	Dimension	package (serial number)
02	0.4 x 0.2	WL-CSP (144/145)
03	0.6 x 0.3	WL-CSP (141/142/199)
1U	1.0 x 0.6	DFN (157)

- ③ Type
- ④ Control Code
- ⑤ Number of channel
- ⑥ Serial Number

※RoHS Directive compliant product

3. CHARACTERISTICS

3-1 Ratings

Parameter	Package	Operating Temperature	Storage Temperature
Symbol		T_{OP}	T_{STO}
Unit		$^{\circ}C$	$^{\circ}C$
LXES03TBB1-141	WL-CSP	-40 to +85	-40 to +125
LXES03TAA1-142		-40 to +85	-40 to +125
LXES02TAA1-144		-40 to +85	-40 to +125
LXES02TAA1-145		-40 to +85	-40 to +125
LXES1UTAA1-157 LXES1UTBB1-157	DFN	-40 to +85	-40 to +125
LXES03TAA1-199	WL-CSP	-40 to +85	-40 to +125

3-2 Electrical Characteristics (T=25°C)

Parameter	Reverse Stand-off Voltage	Channel Leakage Current	Break down voltage	ESD per IEC 61000-4-2 (air)	ESD per IEC 61000-4-2 (contact)	ESD per IEC 61000-4-5 (Surge) (8/20 μ s)	Capacitance
Symbol	V_{RWM}	I_{leak}	V_{br}	V_{esd}	V_{esd}	I_{pp}	C
Unit	V	nA	V	kV	kV	A	pF
Condition		$V_{P_{in1}}=5V$, $V_{P_{in2}}=0V$	$I_{br}=1mA$, P_{in1} to P_{in2}	$T_a=25^{\circ}C$	$T_a=25^{\circ}C$		$V_{P_{in1,2}}=0V$, $f = 1MHz$, Between Channel pins
LXES03TBB1-141	+/-5.5	50 (max)	7(min)	+/- 25	+/- 8	1.5	0.45
LXES03TAA1-142	+/-5.5	50 (max)	7(min)	+/- 15	+/- 8	3	5
LXES02TAA1-144	+/-5.5	50 (max)	7(min)	+/- 15	+/- 8	3	5
LXES02TAA1-145	+/-5.5	50 (max)	7(min)	+/- 15	+/- 8	1	0.35

Parameter	Reverse Stand-off Voltage	Channel Leakage Current	Break down voltage	ESD per IEC 61000-4-2 (air)	ESD per IEC 61000-4-2 (contact)	ESD per IEC 61000-4-5 (Surge) (8/20 μ s)	Capacitance
Symbol	V_{RWM}	I_{leak}	V_{br}	V_{esd}	V_{esd}	I_{pp}	C
Unit	V	μA	V	kV	kV	A	pF
Condition		$V_{P_{in1}}=5V$, $V_{P_{in2}}=0V$	$I_{br}=1mA$, P_{in1} to P_{in2}	$T_a=25^{\circ}C$	$T_a=25^{\circ}C$		$V_{P_{in1,2}}=0V$, $f = 1MHz$, Between Channel pins
LXES1UTAA1-157 LXES1UTBB1-157	+/-6.0	1.0 (max)	7 (min)	+/- 15	+/- 8	1.5	0.5

Parameter	Reverse Stand-off Voltage	Channel Leakage Current	Break down voltage	ESD per IEC 61000-4-2 (air)	ESD per IEC 61000-4-2 (contact)	ESD per IEC 61000-4-5 (Surge) (8/20 μ s)	Capacitance
Symbol	V_{RWM}	I_{leak}	V_{br}	V_{esd}	V_{esd}	I_{pp}	C
Unit	V	nA	V	kV	kV	A	pF
Condition		$V_{P_{in1}}=5.5V$, $V_{P_{in2}}=0V$	$I_{br}=1mA$, P_{in1} to P_{in2}	$T_a=25^{\circ}C$	$T_a=25^{\circ}C$		$V_{P_{in1,2}}=0V$, $f = 1MHz$, Between Channel pins
LXES03TAA1-199	+/-5.5	100 (max)	7 (min)	+/- 30	+/- 30	1.5	1.0

3-3 Typical Characteristics

LXES03TBB1-141

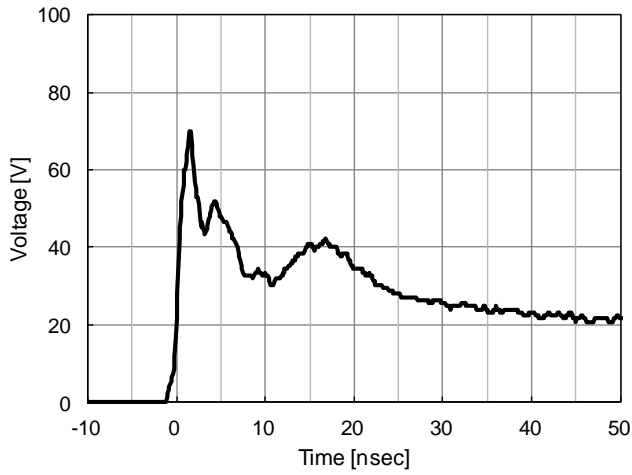

ESD Waveform(IEC61000-4-2:8kV Contact)

LXES03TAA1-142

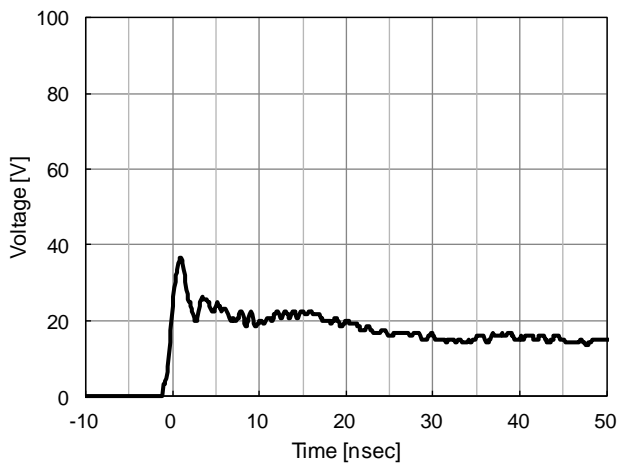

ESD Waveform(IEC61000-4-2:8kV Contact)

LXES02TAA1-144

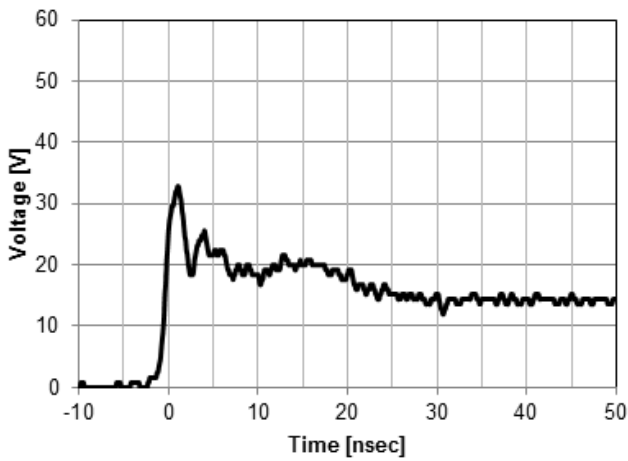

ESD Waveform(IEC61000-4-2:8kV Contact)

LXES02TAA1-145

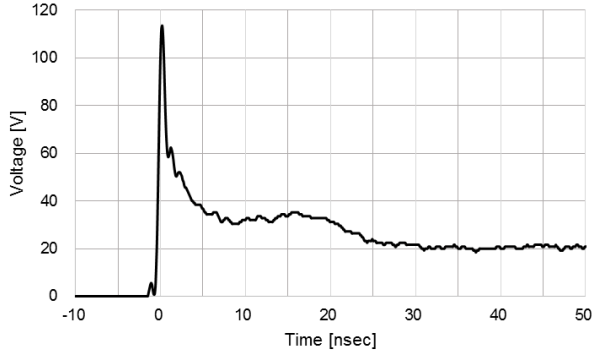

ESD Waveform(IEC61000-4-2: 8kV Contact)

LXES1UTAA1-157/ LXES1UTBB1-157

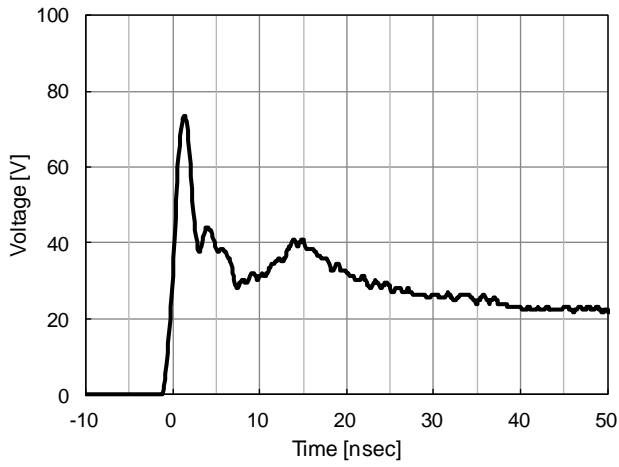

ESD Waveform(IEC61000-4-2: 8kV Contact)

LXES03TAA1-199

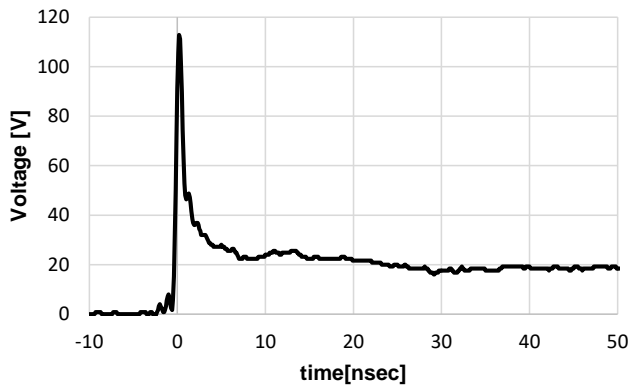

ESD Waveform(IEC61000-4-2: 8kV Contact)

4. CONSTRUCTION, DIMENSIONS

(1) WL-CSP

4 - 1 - 1 DIMENSIONS

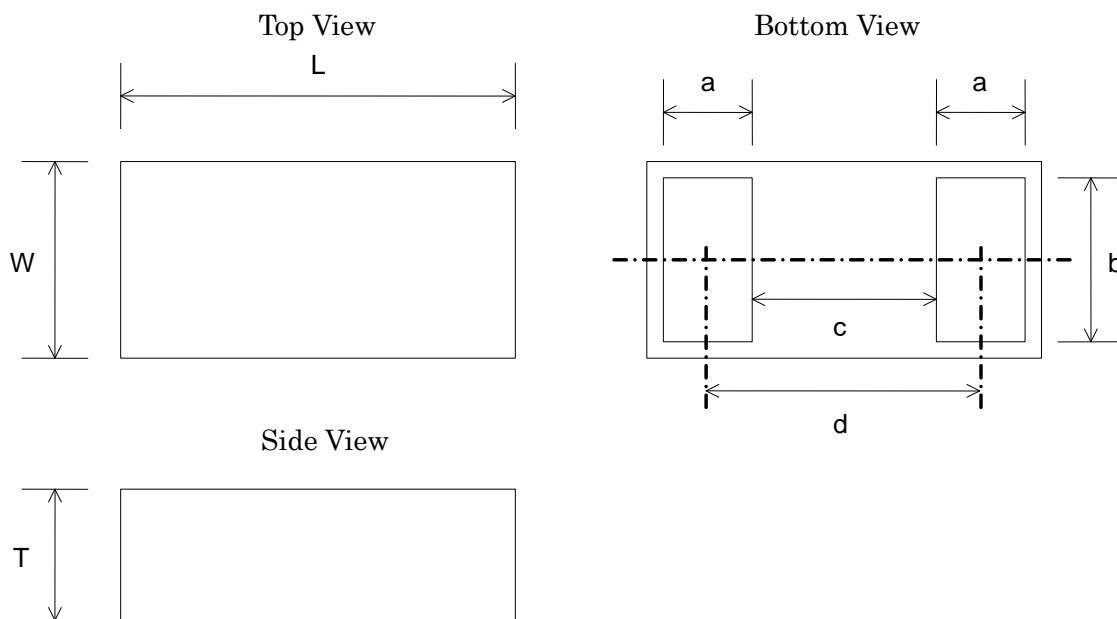

Unit : mm

Size	L	W	T	a	b	c	d
0402	0.40+/-0.015	0.20+/-0.015	0.15 +/-0.01	0.10 +/- 0.015	0.15 +/- 0.015	(0.15)	(0.25)
0603	0.60+/-0.03	0.30+/-0.03	0.20 +/-0.03	0.135 +/- 0.02	0.25 +/- 0.02	(0.28)	(0.415)

4 - 1 - 2 Pin Configuration

No.	Terminal Name
1	Line-1/GND
2	GND/Line-1

4 - 1 - 3 Circuit Diagram

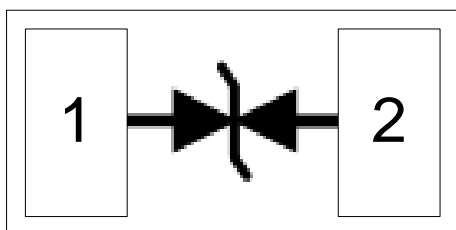

(2) DFN

4 - 2 - 1 DIMENSIONS

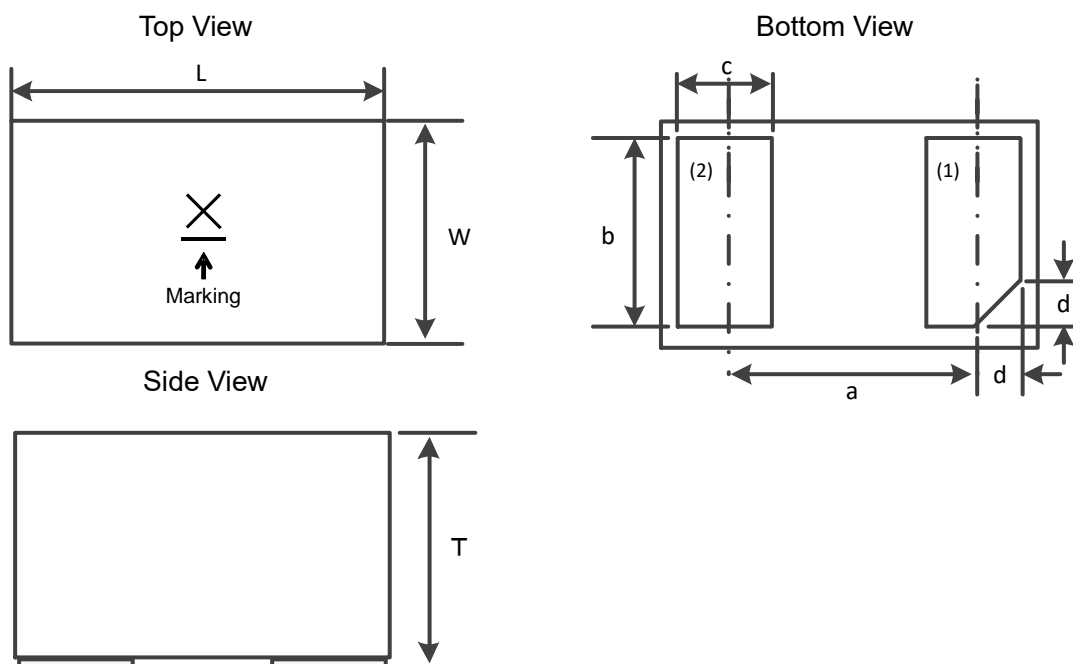

Unit : mm

symbol	size
L	1.0+/-0.05
W	0.6+/-0.05
T	0.37+/-0.03
a	(0.65)

symbol	size
b	0.5+/-0.05
c	0.25+/-0.05
d	(0.125)

4 - 2 - 2 Pin Configuration

No.	Terminal Name
1	Line-1/GND
2	GND/Line-1

4 - 2 - 3 Circuit Diagram

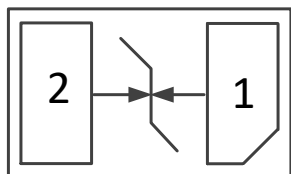

5. Reliability Test

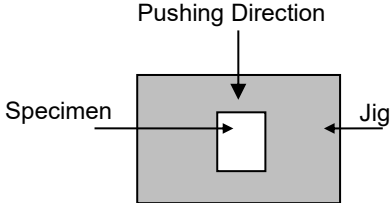
No.	Items	Specifications	Test Methods	Number	Result (Fail)	
1	Vibration Resistance	No severe damages Satisfy dimension specifications	Solder specimens on the testing jig (glass fluorine boards) shown in appended Fig.1 by a Pb free solder. The soldering shall be done either by iron or reflow and be conducted with care so that the soldering is uniform and free of defect such as by heat shock. Frequency : 10~2000 Hz Acceleration : 196 m/s ² Amplitude : 3.0 mm Direction : X,Y,Z 3 axis Period : 2.5 h on each direction Total 7.5 h.	22	G (0)	
2	Shock		Solder specimens on the testing jig (glass fluorine boards) shown in appended Fig.1 by a Pb free solder. The soldering shall be done either by iron or reflow and be conducted with care so that the soldering is uniform and free of defect such as by heat shock pulse waveform: Half sine-wave Acceleration : 14,700 m/s ² Period : 0.5 msec. Cycle : 3 successive shocks be applied in both direction of 3 mutually perpendicular axis(total 18 shocks)	22	G (0)	
3	Deflection		Solder specimens on the testing jig (glass epoxy boards) shown in appended Fig.2 by a Pb free solder. The soldering shall be done either by iron or reflow and be conducted with care so that the soldering is uniform and free of defect such as by heat shock. No damage with 1.6mm deflection	22	G (0)	
4	Soldering strength (Push Strength)	WL-CSP (Only 0603 size) 2N Minimum DFN 3N Minimum	Solder specimens onto test jig shown below. Apply pushing force at 0.5mm/s until electrode pads are peeled off or product is broken. Pushing force is applied to longitudinal direction. 	22	G (0)	
5	Solderability of Termination	95% of the terminations is to be soldered evenly and continuously.	Immerse specimens first an ethanol solution of rosin, then in a Pb free solder solution for 3±0.5 sec. at 245±5 °C. Preheat : 100-120 °C, 60 sec. Solder Paste : Sn-3.0Ag-0.5Cu Flux : Solution of ethanol and rosin (25 % rosin in weight proportion)	22	G (0)	
6	Resistance to Soldering Heat (Reflow)	Appearance Electrical specifications	No severe damages Satisfy specifications listed in paragraph 3-2 over operational temperature range	Preheat Temperature : 150-200 °C Preheat Period : 90+/-30 s High Temperature : 217°C High Temp. Period : 105+/-45 s Peak Temperature : 260+0/-5 °C Specimens are soldered twice with the above condition, and then kept in room condition for 24 h before measurements.	22	G (0)

No.	Items		Specifications	Test Methods	Number	Result (Fail)									
7	High Temp. Exposure	Appearance	No severe damages	Temperature : $85 \pm 2^{\circ}\text{C}$ Period : 1000+48/-0 h Room Condition : 2 ~ 24 h	22	G (0)									
8	Temperature Cycle	Electrical Specifications	Satisfy specifications listed in paragraph 3-2 over operational temperature range	Set the specimens to the supporting jig in the same manner and under the same conditions as Fig.1 and conduct the 100 cycles according to the temperatures and time shown in the following table. Set it for 2 to 24 h at room temperature, then measure.	22	G (0)									
				<table border="1"> <thead> <tr> <th>Step</th> <th>Temp($^{\circ}\text{C}$)</th> <th>Time(min)</th> </tr> </thead> <tbody> <tr> <td>1</td> <td>Min. Operating Temp.+0/-3</td> <td>30\pm3</td> </tr> <tr> <td>2</td> <td>Max. Operating Temp.+3/-0</td> <td>30\pm3</td> </tr> </tbody> </table>			Step	Temp($^{\circ}\text{C}$)	Time(min)	1	Min. Operating Temp.+0/-3	30 \pm 3	2	Max. Operating Temp.+3/-0	30 \pm 3
Step	Temp($^{\circ}\text{C}$)			Time(min)											
1	Min. Operating Temp.+0/-3			30 \pm 3											
2	Max. Operating Temp.+3/-0	30 \pm 3													
9	Humidity (Steady State)			Temperature: $85 \pm 2^{\circ}\text{C}$ Humidity: 80~90 %RH Period: 1000+48/-0 h Room Condition: 2 ~ 24 h	22	G (0)									
10	Low Temp. Exposure			Temperature: $-40 \pm 2^{\circ}\text{C}$ Period: 1000+48/-0 h Room Condition: 2 ~ 24 h	22	G (0)									

Fig. 1

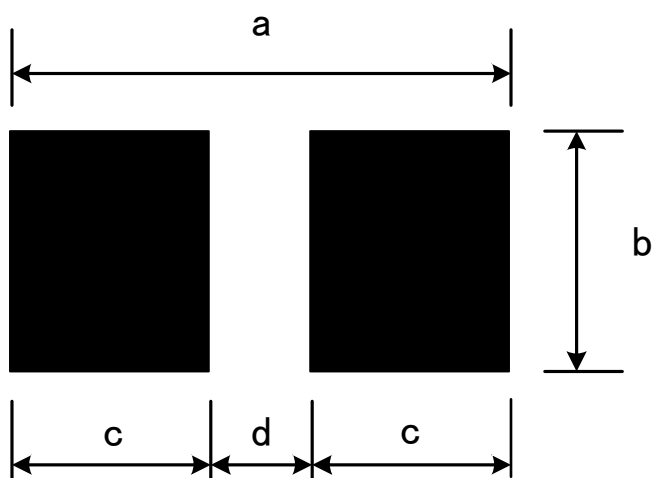
Reference Soldering Footprint

Unit : mm

Package (Size)	a	b	c	d
WL-CSP (0402)	0.45	0.25	0.175	0.1
WL-CSP (0603)	0.665	0.32	0.265	0.135
DFN (1006)	1.0	0.6	0.35	0.3

※Reference purpose only.

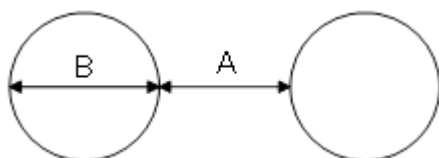
Recommend Stencil Aperture

Unit : mm

Package (Size)	a	b	Stencil thickness
WL-CSP (0402)	0.125	0.15	0.06
WL-CSP (0603)	0.175	0.2	0.08

※Reference purpose only.

Fig. 2 Testing board

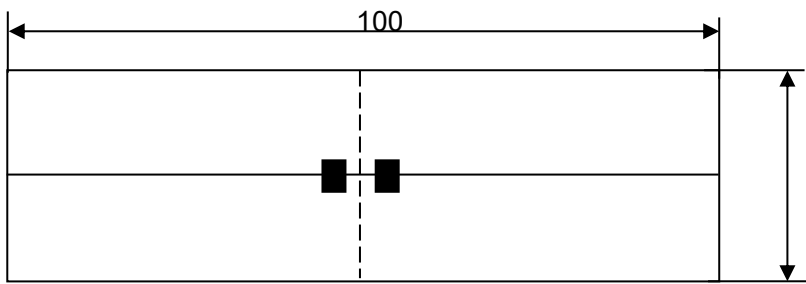

(Unit : mm)

■ Land
Land pattern is same as figure 1
Glass-fluorine board $t=1.6\text{mm}$
Copper thickness over $35\ \mu\text{m}$

Mounted situation

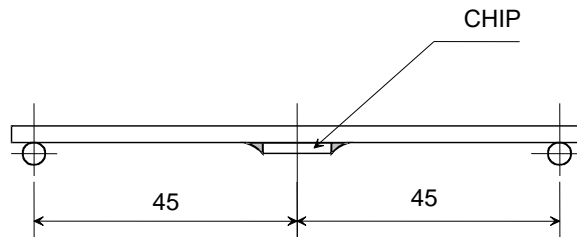

(Unit : mm)

Test method

(Unit : mm)

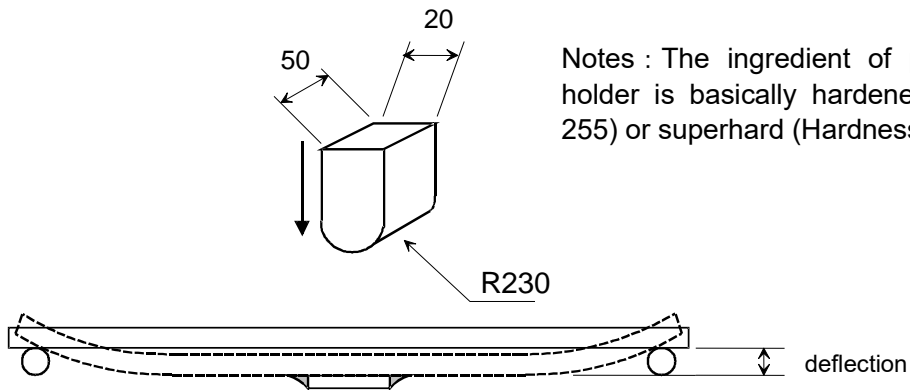

Notes : The ingredient of pressure jig and specimen holder is basically hardened steel(Hardness HB183 ~ 255) or superhard (Hardness over HRA90)

6. Tape and Reel Packing

(1) Dimensions of Tape

Not in scale

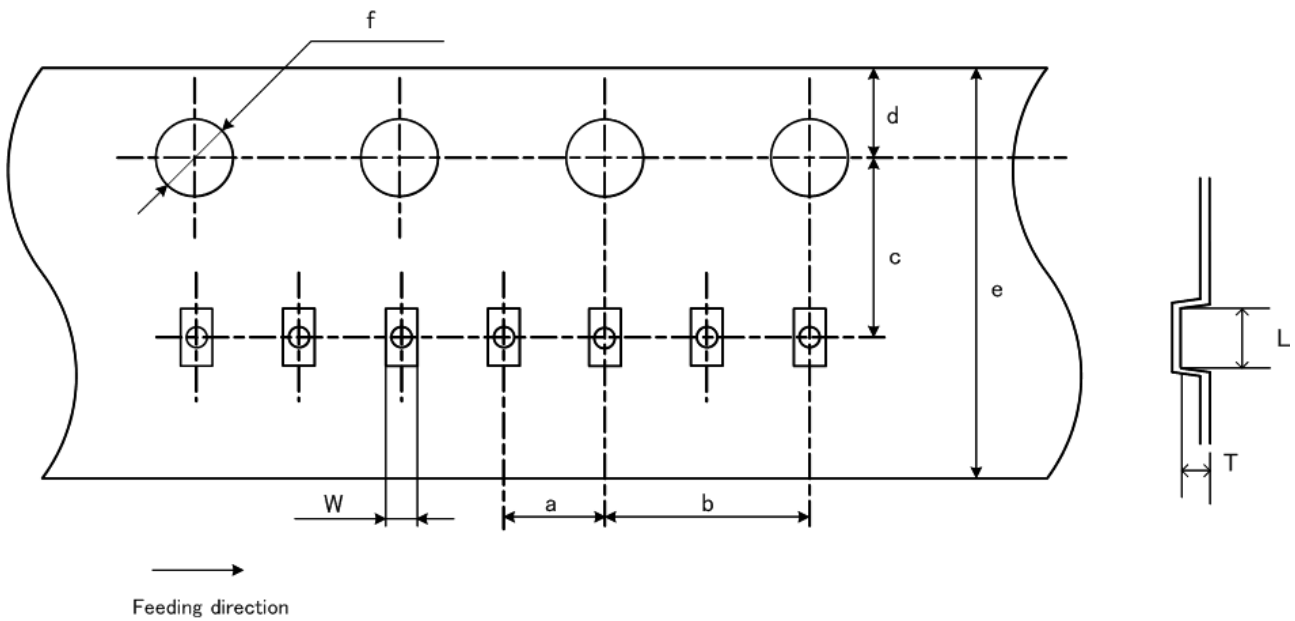

Unit : mm

package	WL-CSP (0402 size)	WL-CSP (0603 size)	DFN
L	(0.46)	(0.67)	(1.18)
W	(0.26)	(0.37)	(0.79)
T	(0.205)	(0.27)	(0.45)
a	2.00+/-0.05	2.00+/-0.05	2.00+/-0.05
b	4.00+/-0.10	4.00+/-0.10	4.00+/-0.10
c	(3.50)	(3.50)	(3.50)
d	1.75+/-0.1	1.75+/-0.1	1.75+/-0.1
e	8.00+/-0.20	8.00+/-0.20	8.00+0.30/-0.10
f	ϕ 1.50+0.1/-0	ϕ 1.50+/-0.1	ϕ 1.50+/-0.1

(2) Dimensions of Reel

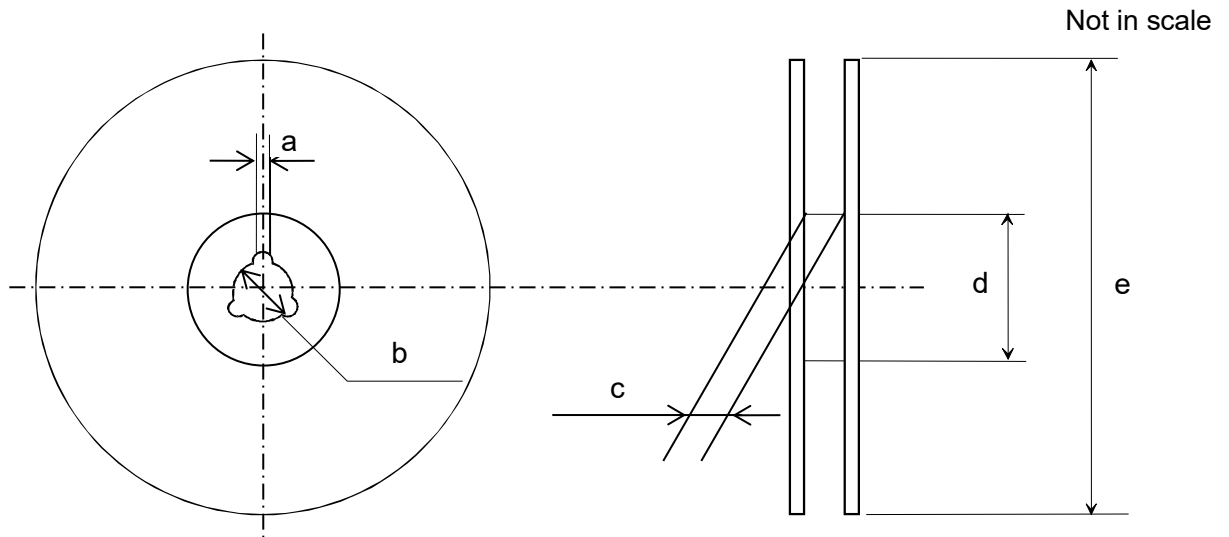

Unit : mm

package	WL-CSP (0402 size)	WL-CSP (0603 size)	DFN
a	1.5 min	1.5 min	1.5 min
b	$\phi 13.0 \pm 0.2$	$\phi 13.0 \pm 0.2$	$\phi 13.0 \pm 0.2$
c	9.0 ± 0.3	9.0 ± 0.3	9.0 ± 0.3
d	$\phi 60$	$\phi 60$	$\phi 60$
e	$\phi 180$	$\phi 180$	$\phi 180$

(4) Taping Diagrams

- [1] Feeding Hole : As specified in (1),(2)
- [2] Hole for chip : As specified in (1),(2)
- [3] Cover tape : 50 μ m in thickness
- [4] Base tape : As specified in (1),(2)

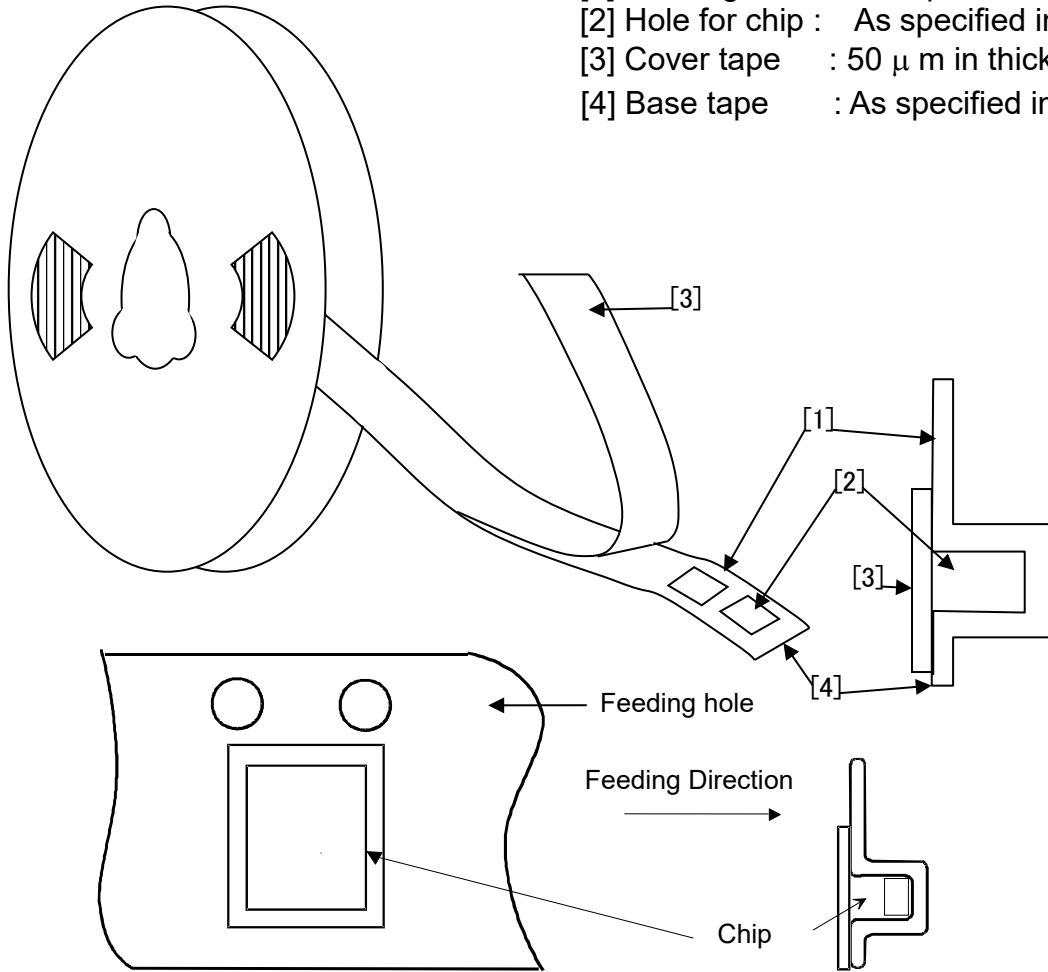

Marking Direction

LXES03TBB1-141

LXES03TAA1-142/199

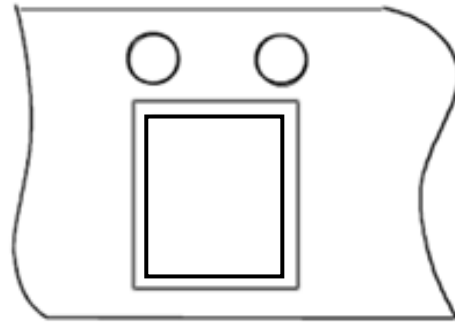
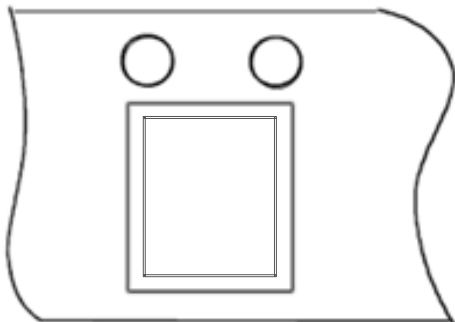

LXES02TAA1-144/145

LXES1UTAA1-157/ LXES1UTBB1-157

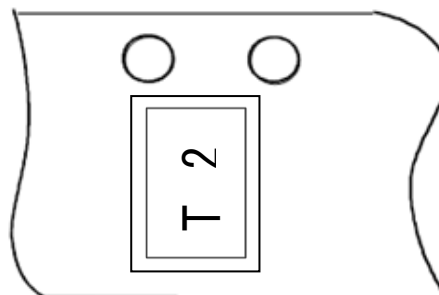
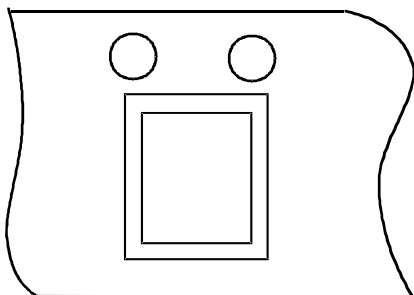

(5) Leader and Tail tape

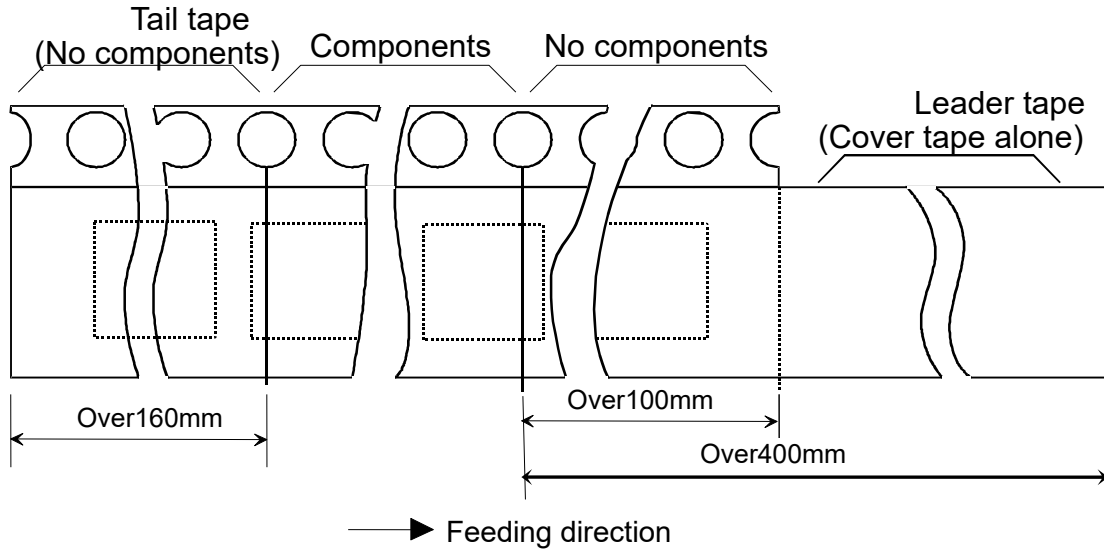

(6) The tape for chips are wound clockwise, the feeding holes to the right side as the tape is pulled toward the user.

(7) Packaging unit:

	Unit : pcs / reel			
package	WL-CSP (0402 size)	WL-CSP (0603 size)	DFN LXES1UTAA1-157	DFN LXES1UTBB1-157
quantity	20,000	20,000	10,000	1,000

(8) Material : Base tape Plastic
 ReelPlastic

Base tape, Reel and Top tape have an anti-ESD function.

(9) Peeling of force : 0.1~1.0 N in the direction of peeling as shown below.

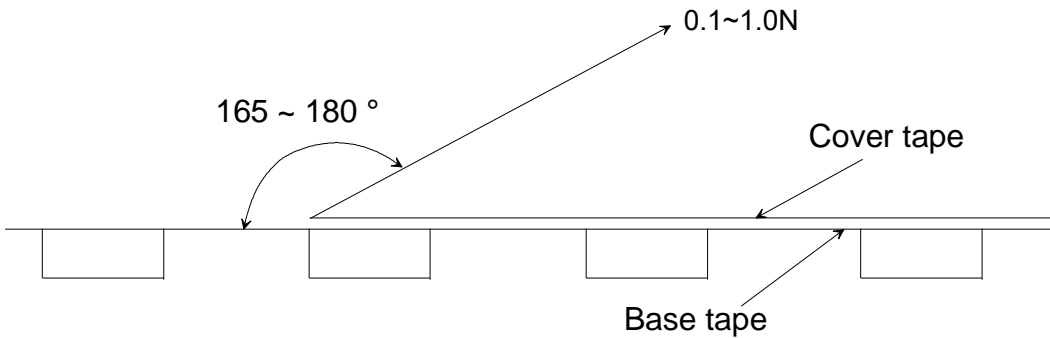

NOTICE

1. Storage Conditions:

To avoid damaging the solderability of the external electrodes, be sure to observe the following points.

- Store products where the ambient temperature is 15 to 35 °C and humidity 45 to 75% RH. (Packing materials, In particular, may be deformed at the temperature over 40 °C.).
- Store products in non corrosive gas (Cl₂, NH₃, SO₂, No_x, etc.).
- Stored products should be used within 6 months of receipt. Solderability should be verified if this period is exceeded.

This product is applicable to MSL1 (Based on IPC/JEDEC J-STD-020)

2. Handling Conditions:

Be careful in handling or transporting products because excessive stress or mechanical shock may break products.

Handle with care if products may have cracks or damages on their terminals, the characteristics of products may change. Do not touch products with bare hands that may result in poor solderability.

3. Standard PCB Design (Land Pattern and Dimensions):

All the ground terminals should be connected to the ground patterns. Furthermore, the ground pattern should be provided between IN and OUT terminals. Please refer to the specifications for the standard land dimensions.

The recommended land pattern and dimensions is as Murata's standard. The characteristics of products may vary depending on the pattern drawing method, grounding method, land dimensions, land forming method of the NC terminals and the PCB material and thickness. Therefore, be sure to verify the characteristics in the actual set. When using non-standard lands, contact Murata beforehand.

4. Notice for Chip Placer:

When placing products on the PCB, products may be stressed and broken by uneven forces from a worn-out chucking locating claw or a suction nozzle. To prevent products from damages, be sure to follow the specifications for the maintenance of the chip placer being used. For the positioning of products on the PCB, be aware that mechanical chucking may damage products.

5. Soldering Conditions:

Carefully perform preheating so that the temperature difference (ΔT) between the solder and products surface should be in the following range. When products are immersed in solvent after mounting, pay special attention to maintain the temperature difference within 100 °C. Soldering must be carried out by the above mentioned conditions to prevent products from damage. Contact Murata before use if concerning other soldering conditions.

Soldering method	Temperature
Reflow method	$\Delta T \leq 130 \text{ }^\circ\text{C}$

Reflow soldering standard conditions(Example)

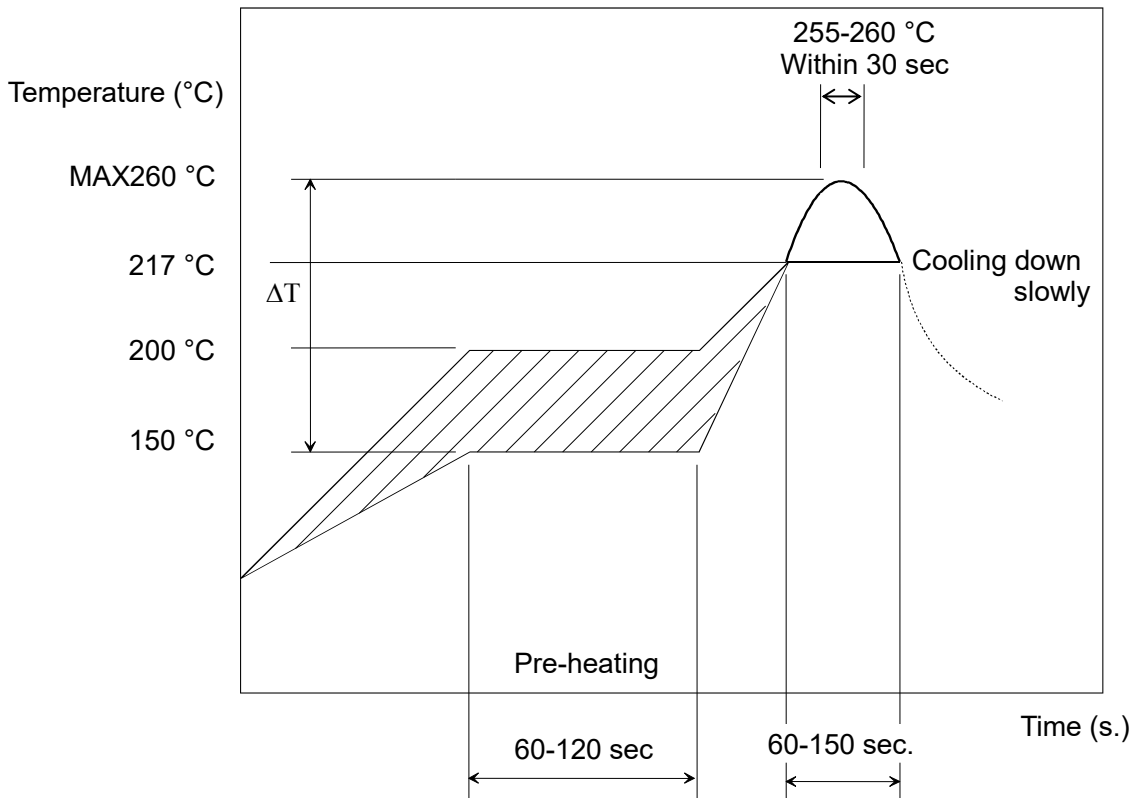

Use rosin type flux or weakly active flux with a chlorine content of 0.2 wt % or less.

6. Cleaning Conditions:

Any cleaning is not permitted.

7. Operational Environment Conditions:

Products are designed to work for electronic products under normal environmental conditions (ambient temperature, humidity and pressure). Therefore, products have no problems to be used under the similar conditions to the above-mentioned. However, if products are used under the following circumstances, it may damage products and leakage of electricity and abnormal temperature may occur.

- In an atmosphere containing corrosive gas (Cl₂, NH₃, SO_x, NO_x etc.).
- In an atmosphere containing combustible and volatile gases.
- In a dusty environment.
- Direct sunlight
- Water splashing place.
- Humid place where water condenses.
- In a freezing environment.

If there are possibilities for products to be used under the preceding clause, consult with Murata before actual use.

If product malfunctions may result in serious damage, including that to human life, sufficient fail-safe measures must be taken, including the following:

- (1) Installation of protection circuits or other protective device to improve system safety
- (2) Installation of redundant circuits in the case of single-circuit failure

8. Limitation of Applications:

The products are designed and produced for application in ordinary electronic equipment (AV equipment, OA equipment, telecommunication, etc). If the products are to be used in devices requiring extremely high reliability following the application listed below, you should consult with the Murata staff in advance.

- Aircraft equipment.
- Aerospace equipment
- Undersea equipment.
- Power plant control equipment.
- Medical equipment.
- Transportation equipment (vehicles, trains, ships, etc.).
- Traffic signal equipment.
- Disaster prevention / crime prevention equipment.
- Data-processing equipment.
- Application which malfunction or operational error may endanger human life and property of assets.
- Application which related to occurrence the serious damage
- Application of similar complexity and/ or reliability requirements to the applications listed in the above.



Note:

Please make sure that your product has been evaluated and confirmed against your specifications when our product is mounted to your product.

Product specifications are subject to change or our products in it may be discontinued without advance notice.

This catalog is for reference only and not an official product specification document, therefore, please review and approve our official product specification before ordering this product.

Note:

This catalog is for reference only and not an official product specification document, therefore, please review and approve our official product specification before ordering this product.

Mouser Electronics

Authorized Distributor

Click to View Pricing, Inventory, Delivery & Lifecycle Information:

[Murata:](#)

[LXES03TBB1-141](#) [LXES1UTAA1-157](#) [LXES1UTBB1-157](#) [LXES03TAA1-142](#) [LXES02TAA1-144](#) [LXES02TAA1-145](#)
[LXES03TAA1-199](#)