

## 30V, N-Channel NexFET™ Power MOSFETs

 Check for Samples: [CSD17327Q5A](#)

### FEATURES

- **Ultralow  $Q_g$  and  $Q_{gd}$**
- **Low Thermal Resistance**
- **Avalanche Rated**
- **Pb Free Terminal Plating**
- **RoHS Compliant**
- **Halogen Free**
- **SON 5-mm × 6-mm Plastic Package**

### APPLICATIONS

- **Point-of-Load Synchronous Buck in Networking, Telecom and Computing Systems**
- **Optimized for Control FET Applications**

### DESCRIPTION

The NexFET™ power MOSFET has been designed to minimize losses in power conversion applications.

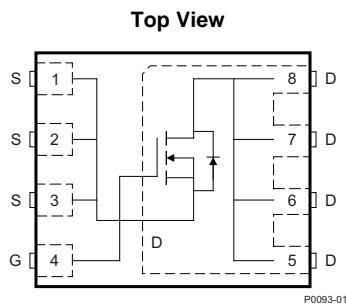

### PRODUCT SUMMARY

|              |                               |                 |         |
|--------------|-------------------------------|-----------------|---------|
| $V_{DS}$     | Drain to Source Voltage       | 30              | V       |
| $Q_g$        | Gate Charge Total (4.5V)      | 2.8             | nC      |
| $Q_{gd}$     | Gate Charge Gate to Drain     | 0.8             | nC      |
| $R_{DS(on)}$ | Drain to Source On Resistance | $V_{GS} = 4.5V$ | 12.5 mΩ |
|              |                               | $V_{GS} = 8V$   | 9.9 mΩ  |
| $V_{GS(th)}$ | Threshold Voltage             | 1.6             | V       |

### ORDERING INFORMATION

| Device      | Package                         | Media        | Qty  | Ship          |
|-------------|---------------------------------|--------------|------|---------------|
| CSD17327Q5A | SON 5-mm × 6-mm Plastic Package | 13-Inch Reel | 2500 | Tape and Reel |

### ABSOLUTE MAXIMUM RATINGS

| $T_A = 25^\circ\text{C}$ unless otherwise stated |  | VALUE      | UNIT             |
|--|--|------------|------------------|
| $V_{DS}$   | Drain to Source Voltage  | 30         | V                |
| $V_{GS}$   | Gate to Source Voltage   | +10 / -10  | V                |
| $I_D$  | Continuous Drain Current, $T_C = 25^\circ\text{C}$                       | 65         | A                |
|  | Continuous Drain Current <sup>(1)</sup>                                  | 13         | A                |
| $I_{DM}$   | Pulsed Drain Current, $T_A = 25^\circ\text{C}$ <sup>(2)</sup>            | 85         | A                |
| $P_D$  | Power Dissipation <sup>(1)</sup>   | 3          | W                |
| $T_J, T_{STG}$                                   | Operating Junction and Storage Temperature Range                         | -55 to 150 | $^\circ\text{C}$ |
| $E_{AS}$   | Avalanche Energy, single pulse<br>$I_D = 30A, L = 0.1mH, R_G = 25\Omega$ | 45         | mJ               |

- (1) Typical  $R_{\theta JA} = 44^\circ\text{C/W}$  on 1-inch<sup>2</sup> (6.45-cm<sup>2</sup>), 2-oz. (0.071-mm thick) Cu pad on a 0.06-inch (1.52-mm) thick FR4 PCB.
- (2) Pulse duration  $\leq 300\mu\text{s}$ , duty cycle  $\leq 2\%$

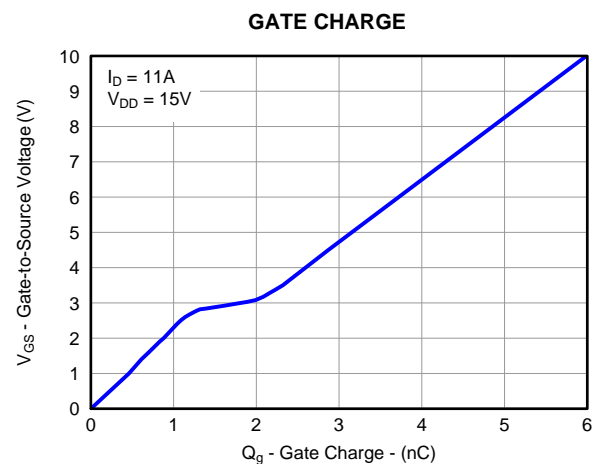
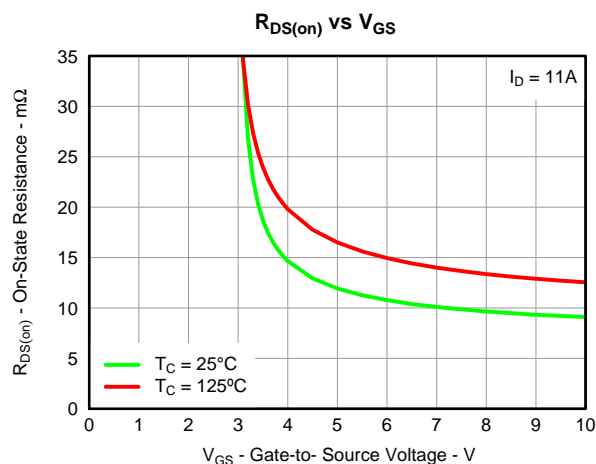

Please be aware that an important notice concerning availability, standard warranty, and use in critical applications of Texas Instruments semiconductor products and disclaimers thereto appears at the end of this data sheet.

NexFET is a trademark of Texas Instruments.

PRODUCTION DATA information is current as of publication date. Products conform to specifications per the terms of the Texas Instruments standard warranty. Production processing does not necessarily include testing of all parameters.



These devices have limited built-in ESD protection. The leads should be shorted together or the device placed in conductive foam during storage or handling to prevent electrostatic damage to the MOS gates.

## ELECTRICAL CHARACTERISTICS

( $T_A = 25^\circ\text{C}$  unless otherwise stated)

| PARAMETER                      |                                  | TEST CONDITIONS   | MIN                         | TYP  | MAX  | UNIT      |
|--------------------------------|----------------------------------|---|-----------------------------|------|------|-----------|
| <b>Static Characteristics</b>  |                                  |   |                             |      |      |           |
| $BV_{DSS}$                     | Drain to Source Voltage          | $V_{GS} = 0V, I_{DS} = 250\mu A$                                | 30                          |      |      | V         |
| $I_{DSS}$                      | Drain to Source Leakage Current  | $V_{GS} = 0V, V_{DS} = 24V$                                     |                             |      | 1    | $\mu A$   |
| $I_{GSS}$                      | Gate to Source Leakage Current   | $V_{DS} = 0V, V_{GS} = +10/-10V$                                |                             |      | 100  | nA        |
| $V_{GS(th)}$                   | Gate to Source Threshold Voltage | $V_{DS} = V_{GS}, I_{DS} = 250\mu A$                            | 1.1                         | 1.6  | 2.0  | V         |
| $R_{DS(on)}$                   | Drain to Source On Resistance    | $V_{GS} = 4.5V, I_{DS} = 11A$                                   |                             | 12.5 | 15.5 | $m\Omega$ |
|                                |                                  | $V_{GS} = 8V, I_{DS} = 11A$                                     |                             | 9.9  | 12.2 | $m\Omega$ |
| $g_{fs}$                       | Transconductance                 | $V_{DS} = 15V, I_{DS} = 11A$                                    |                             | 44   |      | S         |
| <b>Dynamic Characteristics</b> |                                  |   |                             |      |      |           |
| $C_{iss}$                      | Input Capacitance                | $V_{GS} = 0V, V_{DS} = 15V,$<br>$f = 1MHz$                      |                             | 422  | 506  | pF        |
| $C_{oss}$                      | Output Capacitance               |   |                             | 286  | 343  | pF        |
| $C_{riss}$                     | Reverse Transfer Capacitance     |   |                             | 26   | 33   | pF        |
| $R_G$                          | Series Gate Resistance           | $V_{DS} = 15V, I_{DS} = 11A$                                    |                             | 4.7  |      | $\Omega$  |
| $Q_g$                          | Gate Charge Total (4.5V)         |   |                             | 2.8  | 3.4  | nC        |
| $Q_{gd}$                       | Gate Charge Gate to Drain        |   |                             | 0.8  |      | nC        |
| $Q_{gs}$                       | Gate Charge Gate to Source       |   |                             | 1.2  |      | nC        |
| $Q_{g(th)}$                    | Gate Charge at $V_{th}$          |   |                             | 0.6  |      | nC        |
| $Q_{oss}$                      | Output Charge                    |   | $V_{DS} = 13V, V_{GS} = 0V$ |      | 6.8  |           |
| $t_{d(on)}$                    | Turn On Delay Time               | $V_{DS} = 15V, V_{GS} = 4.5V,$<br>$I_{DS} = 11A, R_G = 2\Omega$ |                             | 5.6  |      | ns        |
| $t_r$                          | Rise Time                        |   |                             | 8.2  |      | ns        |
| $t_{d(off)}$                   | Turn Off Delay Time              |   |                             | 9.8  |      | ns        |
| $t_f$                          | Fall Time                        |   |                             | 3.2  |      | ns        |
| <b>Diode Characteristics</b>   |                                  |   |                             |      |      |           |
| $V_{SD}$                       | Diode Forward Voltage            | $I_{SD} = 11A, V_{GS} = 0V$                                     |                             | 0.85 | 1    | V         |
| $Q_{rr}$                       | Reverse Recovery Charge          | $V_{DS} = 13V, I_F = 11A, di/dt = 300A/\mu s$                   |                             | 10.5 |      | nC        |
| $t_{rr}$                       | Reverse Recovery Time            |   |                             | 14.6 |      | ns        |

## THERMAL CHARACTERISTICS

( $T_A = 25^\circ\text{C}$  unless otherwise stated)

| PARAMETER       |  | MIN | TYP | MAX | UNIT               |
|-----------------|--|-----|-----|-----|--------------------|
| $R_{\theta JC}$ | Thermal Resistance Junction to Case <sup>(1)</sup>       |     |     | 1.9 | $^\circ\text{C/W}$ |
| $R_{\theta JA}$ | Thermal Resistance Junction to Ambient <sup>(1)(2)</sup> |     |     | 51  | $^\circ\text{C/W}$ |

- (1)  $R_{\theta JC}$  is determined with the device mounted on a 1-inch<sup>2</sup> (6.45-cm<sup>2</sup>), 2-oz. (0.071-mm thick) Cu pad on a 1.5-inch × 1.5-inch (3.81-cm × 3.81-cm), 0.06-inch (1.52-mm) thick FR4 PCB.  $R_{\theta JC}$  is specified by design, whereas  $R_{\theta JA}$  is determined by the user's board design.
- (2) Device mounted on FR4 material with 1-inch<sup>2</sup> (6.45-cm<sup>2</sup>), 2-oz. (0.071-mm thick) Cu.

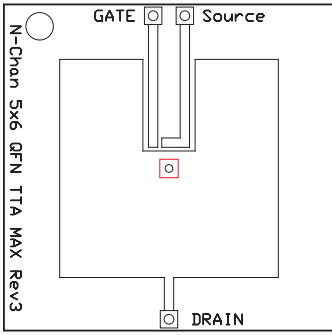

Max  $R_{\theta JA} = 51^\circ\text{C/W}$   
when mounted on  
1 inch<sup>2</sup> (6.45 cm<sup>2</sup>) of  
2-oz. (0.071-mm thick)  
Cu.

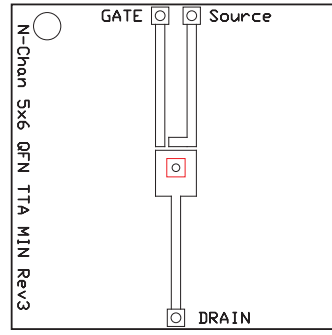

Max  $R_{\theta JA} = 131^\circ\text{C/W}$   
when mounted on a  
minimum pad area of  
2-oz. (0.071-mm thick)  
Cu.

### TYPICAL MOSFET CHARACTERISTICS

( $T_A = 25^\circ\text{C}$  unless otherwise stated)

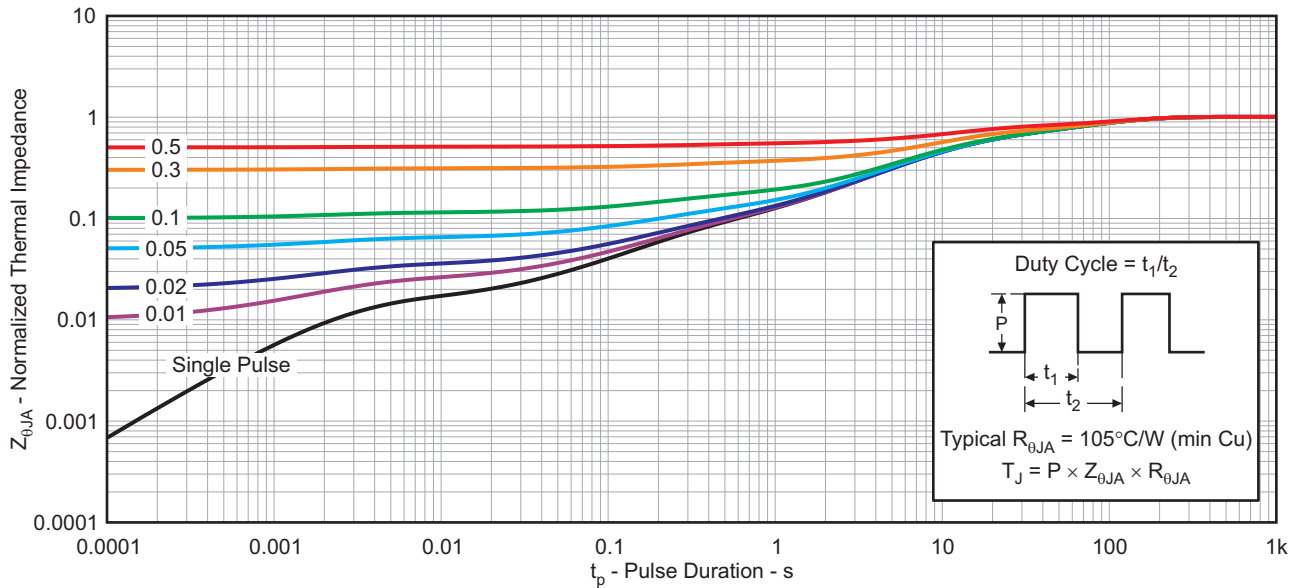
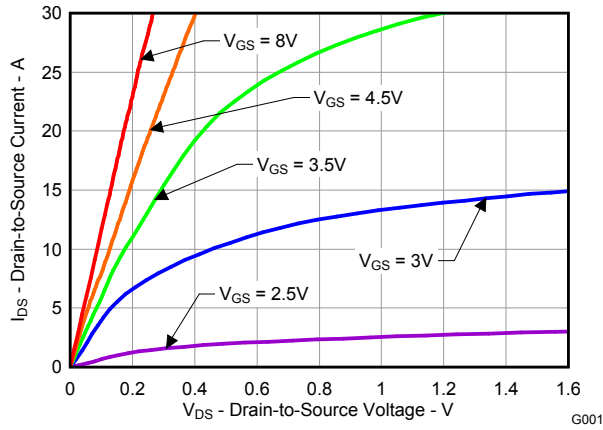

Figure 1. Transient Thermal Impedance

G012

**TYPICAL MOSFET CHARACTERISTICS (continued)**

( $T_A = 25^\circ\text{C}$  unless otherwise stated)



**Figure 2. Saturation Characteristics**

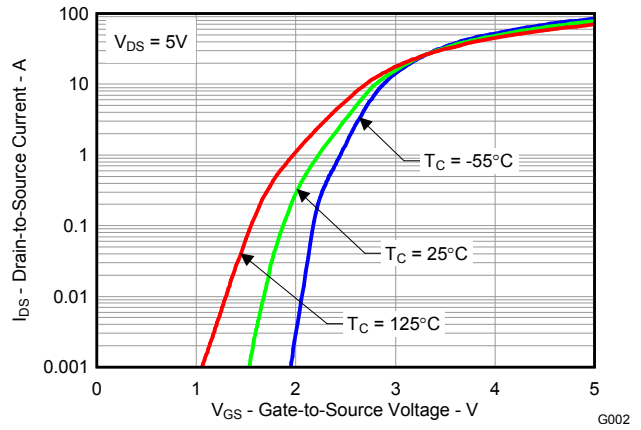

**Figure 3. Transfer Characteristics**

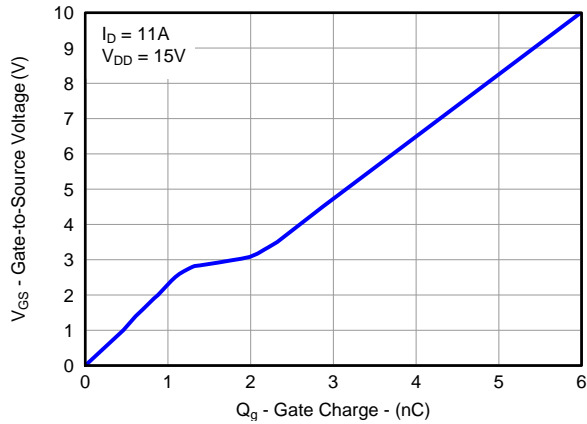

**Figure 4. Gate Charge**

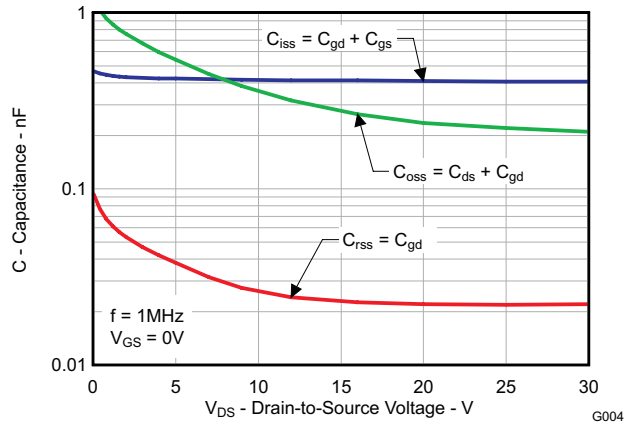

**Figure 5. Capacitance**

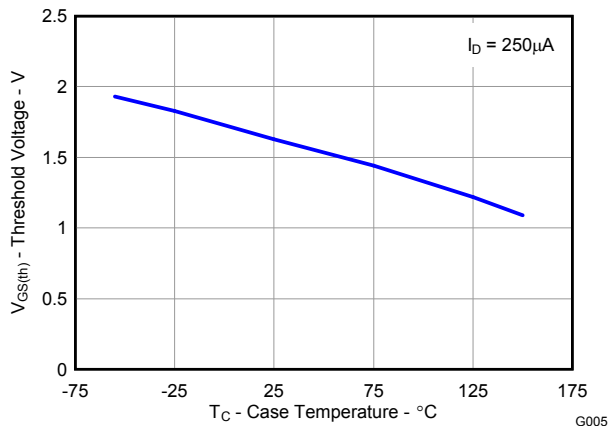

**Figure 6. Threshold Voltage vs. Temperature**

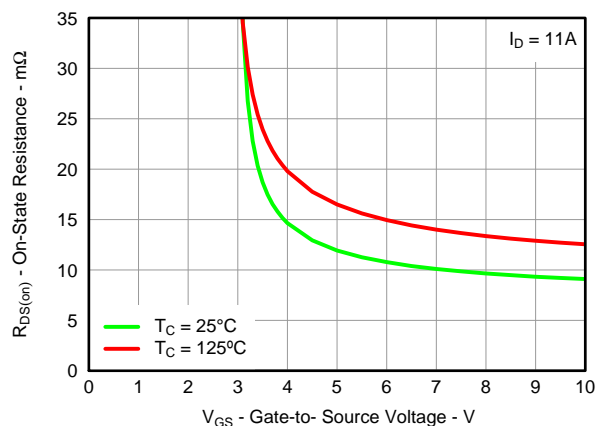

**Figure 7. On-State Resistance vs. Gate-to-Source Voltage**

TYPICAL MOSFET CHARACTERISTICS (continued)

( $T_A = 25^\circ\text{C}$  unless otherwise stated)

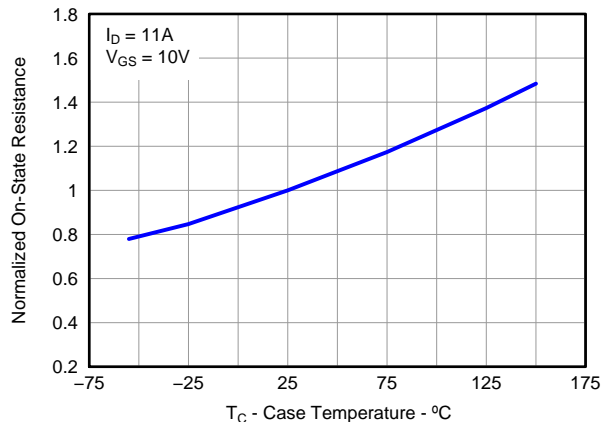

Figure 8. Normalized On-State Resistance vs. Temperature

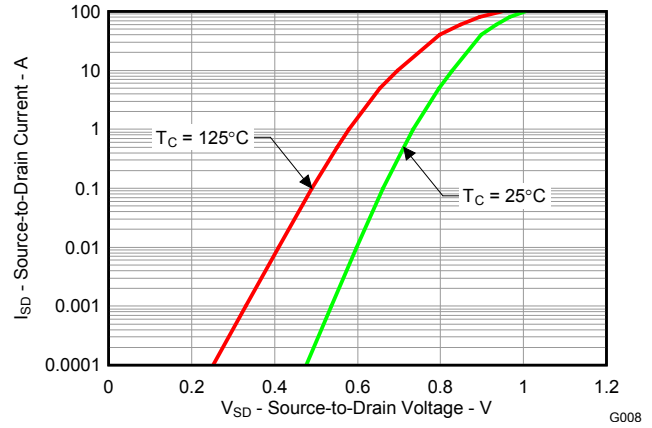

Figure 9. Typical Diode Forward Voltage

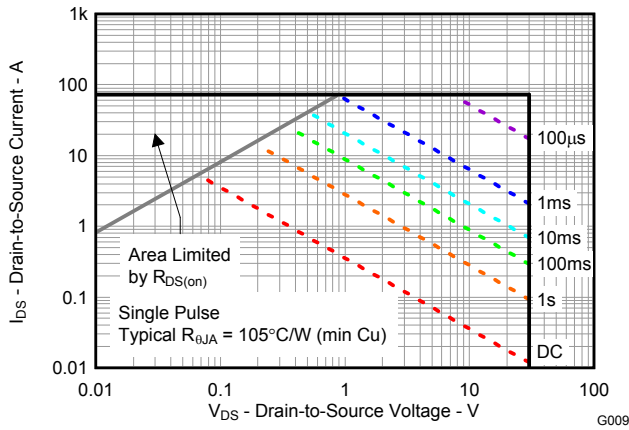

Figure 10. Maximum Safe Operating Area

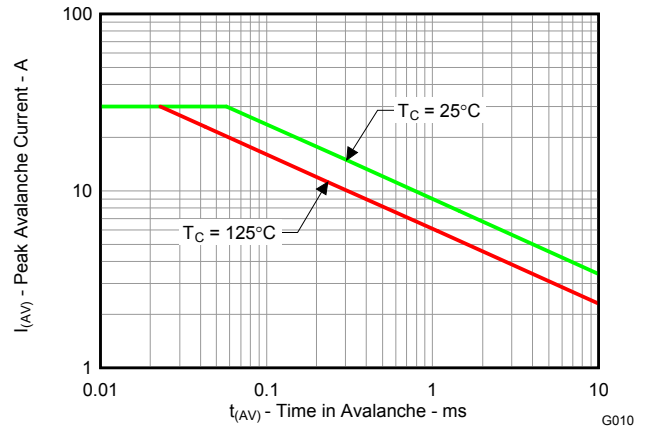

Figure 11. Single Pulse Unclamped Inductive Switching

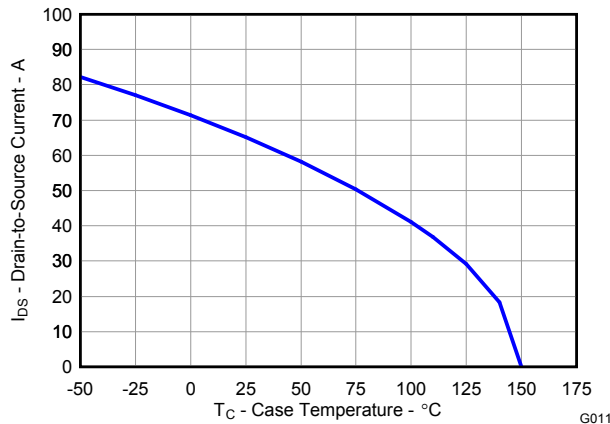

Figure 12. Maximum Drain Current vs. Temperature

**MECHANICAL DATA**

**Q5A Package Dimensions**



M0135-01

| DIM      | MILLIMETERS |      |      |
|----------|-------------|------|------|
|          | MIN         | NOM  | MAX  |
| A        | 0.90        | 1.00 | 1.10 |
| b        | 0.33        | 0.41 | 0.51 |
| c        | 0.20        | 0.25 | 0.34 |
| D1       | 4.80        | 4.90 | 5.00 |
| D2       | 3.61        | 3.81 | 4.02 |
| E        | 5.90        | 6.00 | 6.10 |
| E1       | 5.70        | 5.75 | 5.80 |
| E2       | 3.38        | 3.58 | 3.78 |
| e        | 1.17        | 1.27 | 1.37 |
| H        | 0.41        | 0.56 | 0.71 |
| K        | 1.10        |      |      |
| L        | 0.51        | 0.61 | 0.71 |
| L1       | 0.06        | 0.13 | 0.20 |
| $\theta$ | 0°          |      | 12°  |

### Recommended PCB Pattern

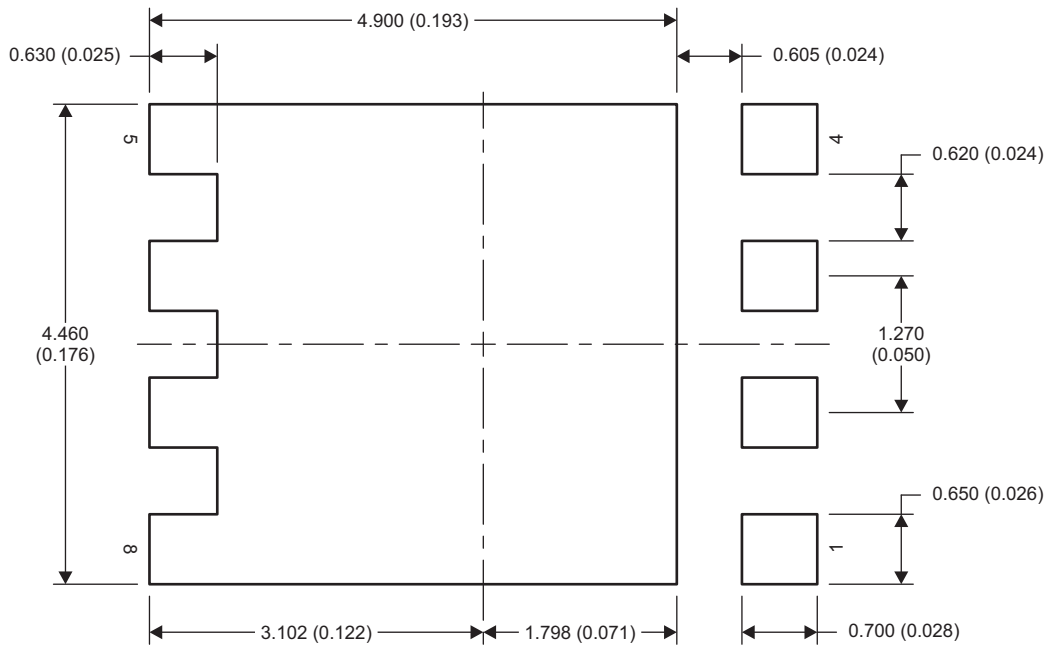

M0139-01

NOTE: Dimensions are in mm (inches).

### Stencil Recommendation

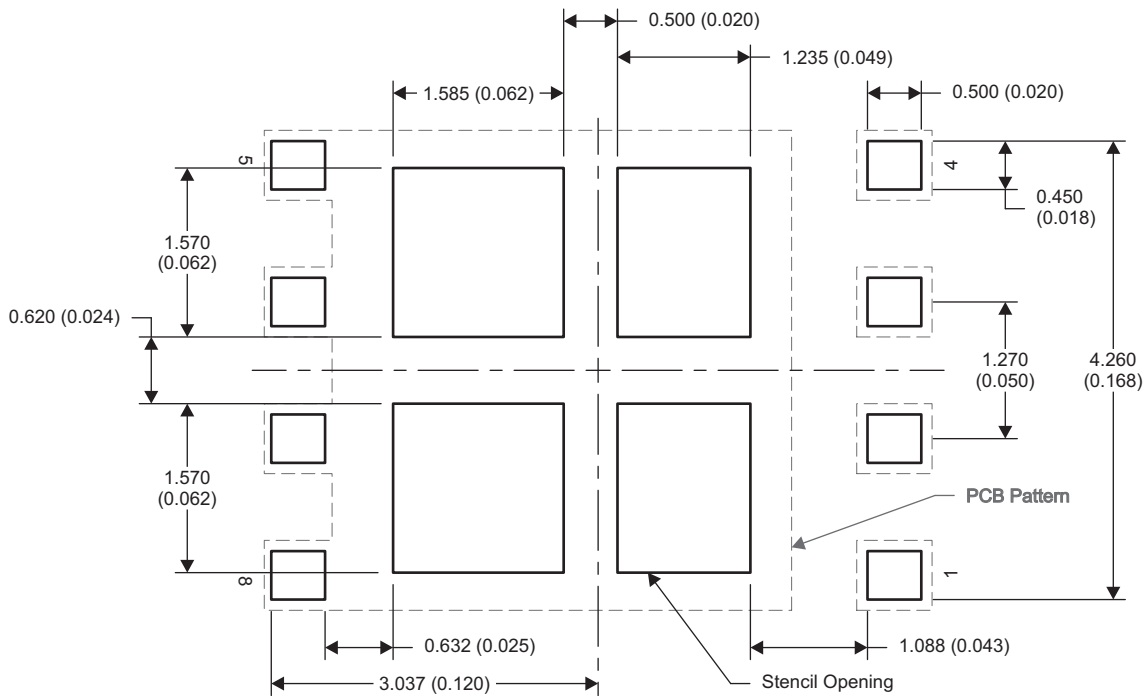

M0209-01

NOTE: Dimensions are in mm (inches).

For recommended circuit layout for PCB designs, see application note [SLPA005](#) – *Reducing Ringing Through PCB Layout Techniques*.

**Q5A Tape and Reel Information**

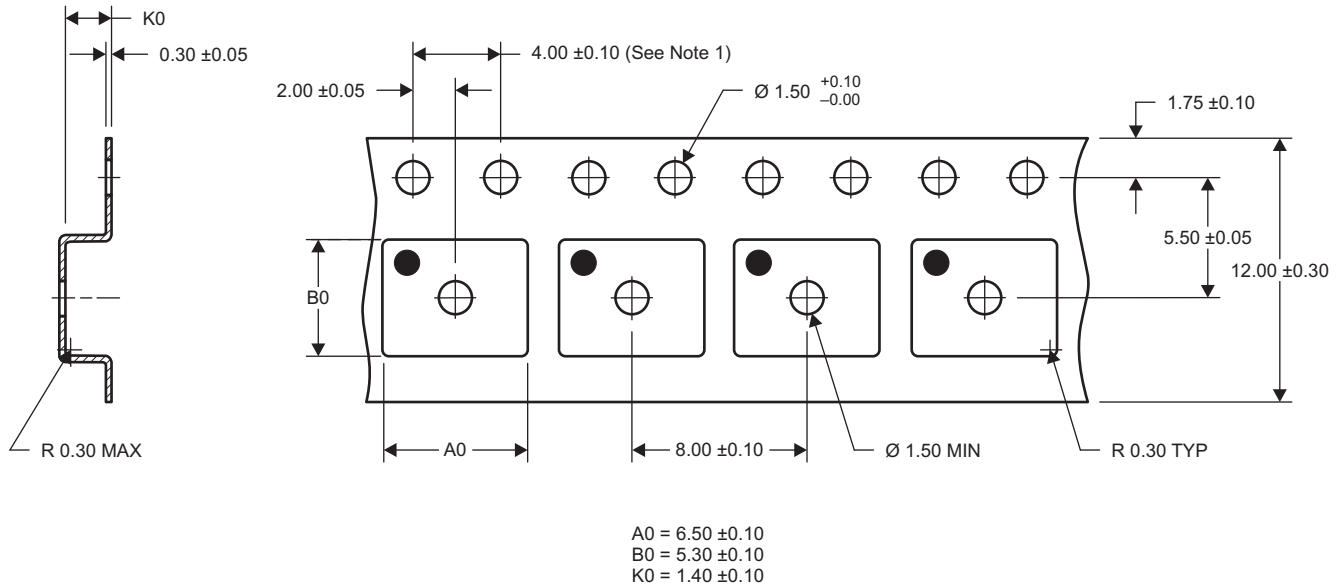

M0138-01

- NOTES: 1. 10-sprocket hole-pitch cumulative tolerance  $\pm 0.2$
2. Camber not to exceed 1mm in 100mm, noncumulative over 250mm
3. Material: black static-dissipative polystyrene
4. All dimensions are in mm (unless otherwise specified)
5. A0 and B0 measured on a plane 0.3mm above the bottom of the pocket



**PACKAGING INFORMATION**

| Orderable Device | Status<br>(1) | Package Type | Package Drawing | Pins | Package Qty | Eco Plan<br>(2)       | Lead/Ball Finish<br>(6) | MSL Peak Temp<br>(3) | Op Temp (°C) | Device Marking<br>(4/5) | Samples |
|------------------|---------------|--------------|-----------------|------|-------------|-----------------------|-------------------------|----------------------|--------------|-------------------------|---------|
| CSD17327Q5A      | ACTIVE        | VSONP        | DQJ             | 8    | 2500        | Pb-Free (RoHS Exempt) | CU SN                   | Level-1-260C-UNLIM   | -55 to 150   | CSD17327                | Samples |

(1) The marketing status values are defined as follows:

**ACTIVE:** Product device recommended for new designs.

**LIFEBUY:** TI has announced that the device will be discontinued, and a lifetime-buy period is in effect.

**NRND:** Not recommended for new designs. Device is in production to support existing customers, but TI does not recommend using this part in a new design.

**PREVIEW:** Device has been announced but is not in production. Samples may or may not be available.

**OBSOLETE:** TI has discontinued the production of the device.

(2) Eco Plan - The planned eco-friendly classification: Pb-Free (RoHS), Pb-Free (RoHS Exempt), or Green (RoHS & no Sb/Br) - please check <http://www.ti.com/productcontent> for the latest availability information and additional product content details.

**TBD:** The Pb-Free/Green conversion plan has not been defined.

**Pb-Free (RoHS):** TI's terms "Lead-Free" or "Pb-Free" mean semiconductor products that are compatible with the current RoHS requirements for all 6 substances, including the requirement that lead not exceed 0.1% by weight in homogeneous materials. Where designed to be soldered at high temperatures, TI Pb-Free products are suitable for use in specified lead-free processes.

**Pb-Free (RoHS Exempt):** This component has a RoHS exemption for either 1) lead-based flip-chip solder bumps used between the die and package, or 2) lead-based die adhesive used between the die and leadframe. The component is otherwise considered Pb-Free (RoHS compatible) as defined above.

**Green (RoHS & no Sb/Br):** TI defines "Green" to mean Pb-Free (RoHS compatible), and free of Bromine (Br) and Antimony (Sb) based flame retardants (Br or Sb do not exceed 0.1% by weight in homogeneous material)

(3) MSL, Peak Temp. - The Moisture Sensitivity Level rating according to the JEDEC industry standard classifications, and peak solder temperature.

(4) There may be additional marking, which relates to the logo, the lot trace code information, or the environmental category on the device.

(5) Multiple Device Markings will be inside parentheses. Only one Device Marking contained in parentheses and separated by a "~" will appear on a device. If a line is indented then it is a continuation of the previous line and the two combined represent the entire Device Marking for that device.

(6) Lead/Ball Finish - Orderable Devices may have multiple material finish options. Finish options are separated by a vertical ruled line. Lead/Ball Finish values may wrap to two lines if the finish value exceeds the maximum column width.

**Important Information and Disclaimer:** The information provided on this page represents TI's knowledge and belief as of the date that it is provided. TI bases its knowledge and belief on information provided by third parties, and makes no representation or warranty as to the accuracy of such information. Efforts are underway to better integrate information from third parties. TI has taken and continues to take reasonable steps to provide representative and accurate information but may not have conducted destructive testing or chemical analysis on incoming materials and chemicals. TI and TI suppliers consider certain information to be proprietary, and thus CAS numbers and other limited information may not be available for release.

In no event shall TI's liability arising out of such information exceed the total purchase price of the TI part(s) at issue in this document sold by TI to Customer on an annual basis.



## IMPORTANT NOTICE

Texas Instruments Incorporated and its subsidiaries (TI) reserve the right to make corrections, enhancements, improvements and other changes to its semiconductor products and services per JESD46, latest issue, and to discontinue any product or service per JESD48, latest issue. Buyers should obtain the latest relevant information before placing orders and should verify that such information is current and complete. All semiconductor products (also referred to herein as "components") are sold subject to TI's terms and conditions of sale supplied at the time of order acknowledgment.

TI warrants performance of its components to the specifications applicable at the time of sale, in accordance with the warranty in TI's terms and conditions of sale of semiconductor products. Testing and other quality control techniques are used to the extent TI deems necessary to support this warranty. Except where mandated by applicable law, testing of all parameters of each component is not necessarily performed.

TI assumes no liability for applications assistance or the design of Buyers' products. Buyers are responsible for their products and applications using TI components. To minimize the risks associated with Buyers' products and applications, Buyers should provide adequate design and operating safeguards.

TI does not warrant or represent that any license, either express or implied, is granted under any patent right, copyright, mask work right, or other intellectual property right relating to any combination, machine, or process in which TI components or services are used. Information published by TI regarding third-party products or services does not constitute a license to use such products or services or a warranty or endorsement thereof. Use of such information may require a license from a third party under the patents or other intellectual property of the third party, or a license from TI under the patents or other intellectual property of TI.

Reproduction of significant portions of TI information in TI data books or data sheets is permissible only if reproduction is without alteration and is accompanied by all associated warranties, conditions, limitations, and notices. TI is not responsible or liable for such altered documentation. Information of third parties may be subject to additional restrictions.

Resale of TI components or services with statements different from or beyond the parameters stated by TI for that component or service voids all express and any implied warranties for the associated TI component or service and is an unfair and deceptive business practice. TI is not responsible or liable for any such statements.

Buyer acknowledges and agrees that it is solely responsible for compliance with all legal, regulatory and safety-related requirements concerning its products, and any use of TI components in its applications, notwithstanding any applications-related information or support that may be provided by TI. Buyer represents and agrees that it has all the necessary expertise to create and implement safeguards which anticipate dangerous consequences of failures, monitor failures and their consequences, lessen the likelihood of failures that might cause harm and take appropriate remedial actions. Buyer will fully indemnify TI and its representatives against any damages arising out of the use of any TI components in safety-critical applications.

In some cases, TI components may be promoted specifically to facilitate safety-related applications. With such components, TI's goal is to help enable customers to design and create their own end-product solutions that meet applicable functional safety standards and requirements. Nonetheless, such components are subject to these terms.

No TI components are authorized for use in FDA Class III (or similar life-critical medical equipment) unless authorized officers of the parties have executed a special agreement specifically governing such use.

Only those TI components which TI has specifically designated as military grade or "enhanced plastic" are designed and intended for use in military/aerospace applications or environments. Buyer acknowledges and agrees that any military or aerospace use of TI components which have **not** been so designated is solely at the Buyer's risk, and that Buyer is solely responsible for compliance with all legal and regulatory requirements in connection with such use.

TI has specifically designated certain components as meeting ISO/TS16949 requirements, mainly for automotive use. In any case of use of non-designated products, TI will not be responsible for any failure to meet ISO/TS16949.

### Products

|                              |  |
|------------------------------|--|
| Audio                        | <a href="http://www.ti.com/audio">www.ti.com/audio</a>                               |
| Amplifiers                   | <a href="http://amplifier.ti.com">amplifier.ti.com</a>                               |
| Data Converters              | <a href="http://dataconverter.ti.com">dataconverter.ti.com</a>                       |
| DLP® Products                | <a href="http://www.dlp.com">www.dlp.com</a>   |
| DSP                          | <a href="http://dsp.ti.com">dsp.ti.com</a>   |
| Clocks and Timers            | <a href="http://www.ti.com/clocks">www.ti.com/clocks</a>                             |
| Interface                    | <a href="http://interface.ti.com">interface.ti.com</a>                               |
| Logic                        | <a href="http://logic.ti.com">logic.ti.com</a>                                       |
| Power Mgmt                   | <a href="http://power.ti.com">power.ti.com</a>                                       |
| Microcontrollers             | <a href="http://microcontroller.ti.com">microcontroller.ti.com</a>                   |
| RFID                         | <a href="http://www.ti-rfid.com">www.ti-rfid.com</a>                                 |
| OMAP Applications Processors | <a href="http://www.ti.com/omap">www.ti.com/omap</a>                                 |
| Wireless Connectivity        | <a href="http://www.ti.com/wirelessconnectivity">www.ti.com/wirelessconnectivity</a> |

### Applications

|                               |  |
|-------------------------------|--|
| Automotive and Transportation | <a href="http://www.ti.com/automotive">www.ti.com/automotive</a>                         |
| Communications and Telecom    | <a href="http://www.ti.com/communications">www.ti.com/communications</a>                 |
| Computers and Peripherals     | <a href="http://www.ti.com/computers">www.ti.com/computers</a>                           |
| Consumer Electronics          | <a href="http://www.ti.com/consumer-apps">www.ti.com/consumer-apps</a>                   |
| Energy and Lighting           | <a href="http://www.ti.com/energy">www.ti.com/energy</a>                                 |
| Industrial                    | <a href="http://www.ti.com/industrial">www.ti.com/industrial</a>                         |
| Medical                       | <a href="http://www.ti.com/medical">www.ti.com/medical</a>                               |
| Security                      | <a href="http://www.ti.com/security">www.ti.com/security</a>                             |
| Space, Avionics and Defense   | <a href="http://www.ti.com/space-avionics-defense">www.ti.com/space-avionics-defense</a> |
| Video and Imaging             | <a href="http://www.ti.com/video">www.ti.com/video</a>                                   |

### TI E2E Community

[e2e.ti.com](http://e2e.ti.com)