

## Dual 12-/10-Bit 500 MSPS Digital-to-Analog Converters

Check for Samples: [DAC3154](#) , [DAC3164](#)

### FEATURES

- Dual Channel
- Resolution
  - DAC3154: 10-Bit
  - DAC3164: 12-Bit
- Maximum Sample Rate: 500 MSPS
- Pin Compatible Family with DAC3174 and DAC3151/DAC3161/DAC3171
- Input Interface:
  - 12-/10-Bit Wide LVDS Inputs
  - Internal FIFO
- Chip to Chip Synchronization
- Power Dissipation: 460mW
- Spectral Performance at 20 MHz IF
  - SNR: 62 dBFS for DAC3154, 72 dBFS for DAC3164
  - SFDR: 76 dBc for DAC3154, 77 dBc for DAC3164
- Current Sourcing DACs
- Compliance Range: –0.5V to 1V
- Package: 64 Pin QFN (9x9mm)

### APPLICATIONS

- Multi-Carrier, Multi-Mode Cellular Infrastructure Base Stations
- Radar
- Signal Intelligence
- Software-Defined Radio
- Test and Measurement Instrumentation

### DESCRIPTION

The DAC3154/DAC3164 are dual channel 10-/12-bit, pin-compatible family of 500 MSPS digital-to-analog converters (DAC). The DAC3154/DAC3164 use a 10-/12-bit wide LVDS digital bus with an input FIFO. FIFO input and output pointers can be synchronized across multiple devices for precise signal synchronization. The DAC outputs are current sourcing and terminate to GND with a compliance range of –0.5 to 1V. DAC3154/ DAC3164 are pin compatible with the dual-channel, 14-bit, 500 MSPS digital-to-analog converters DAC3174, and the single-channel, 14-/12-10-bit, digital-to-analog converters DAC3171/DAC3161/DAC3151.

The devices are available in a QFN-64 PowerPAD™ package is specified over the full industrial temperature range (–40°C to 85°C).



Please be aware that an important notice concerning availability, standard warranty, and use in critical applications of Texas Instruments semiconductor products and disclaimers thereto appears at the end of this data sheet.

PowerPAD is a trademark of Texas Instruments.

PRODUCTION DATA information is current as of publication date. Products conform to specifications per the terms of the Texas Instruments standard warranty. Production processing does not necessarily include testing of all parameters.

Copyright © 2013, Texas Instruments Incorporated



These devices have limited built-in ESD protection. The leads should be shorted together or the device placed in conductive foam during storage or handling to prevent electrostatic damage to the MOS gates.

**BLOCK DIAGRAMS**

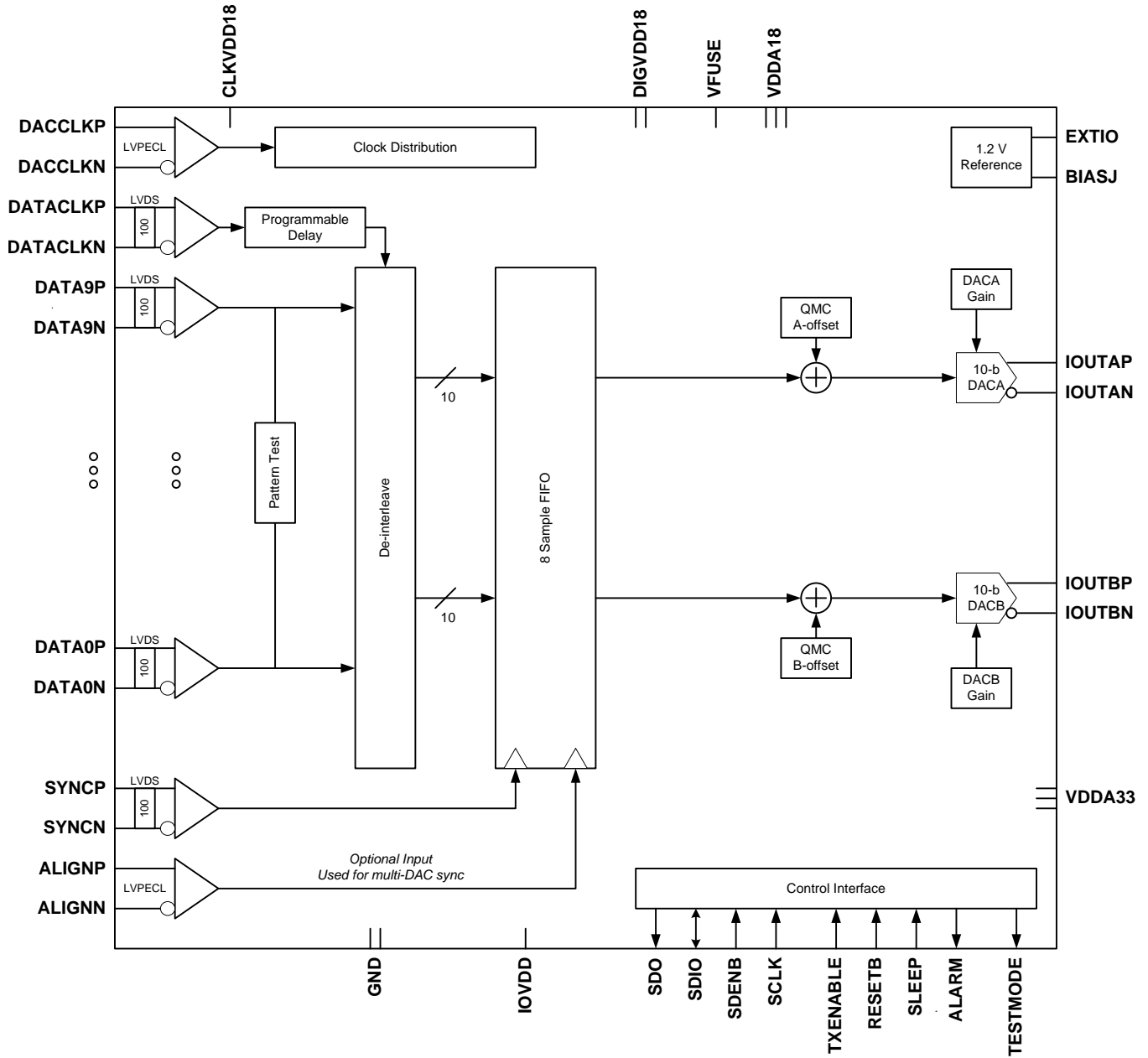

Figure 1. DAC3154

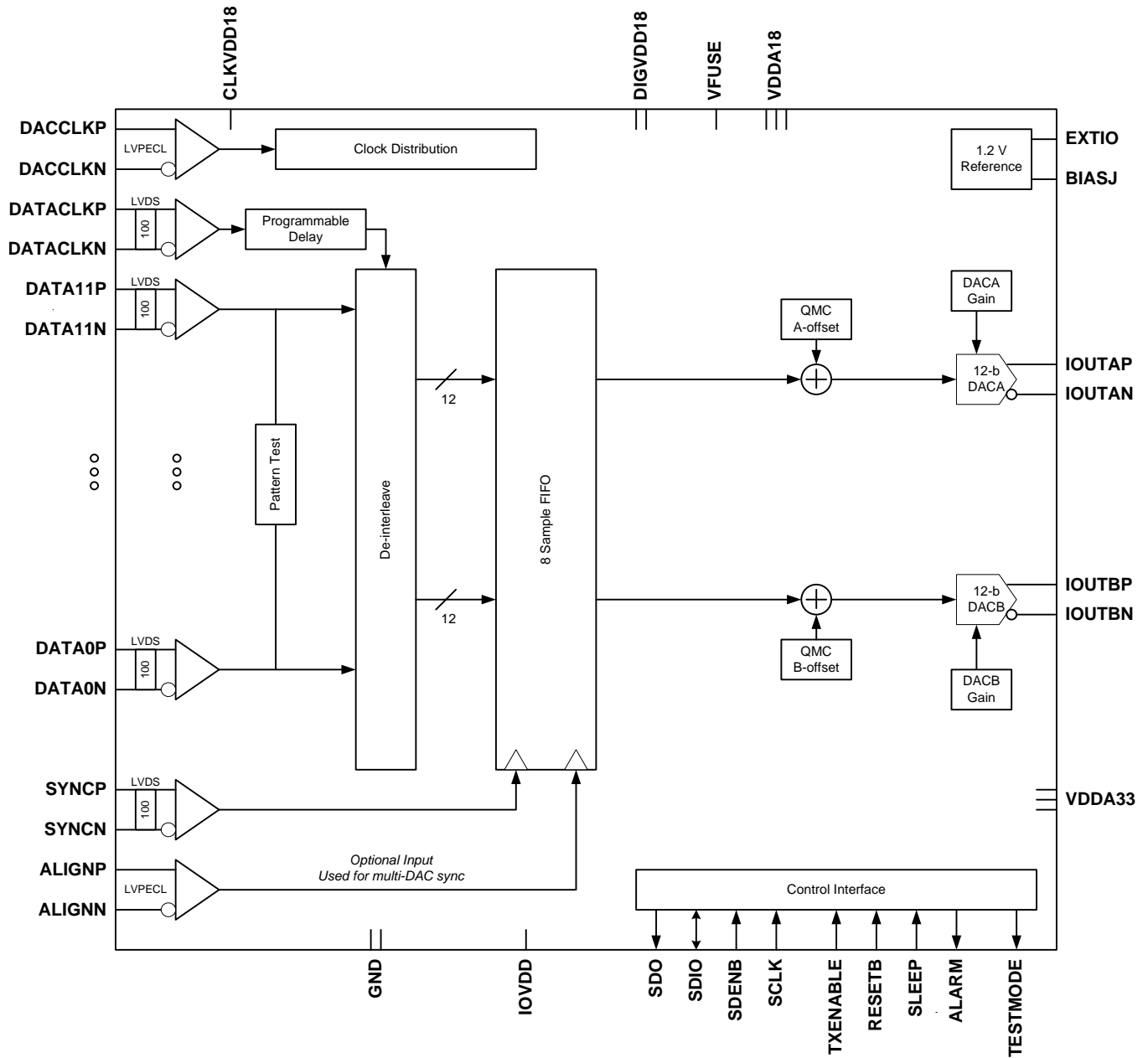
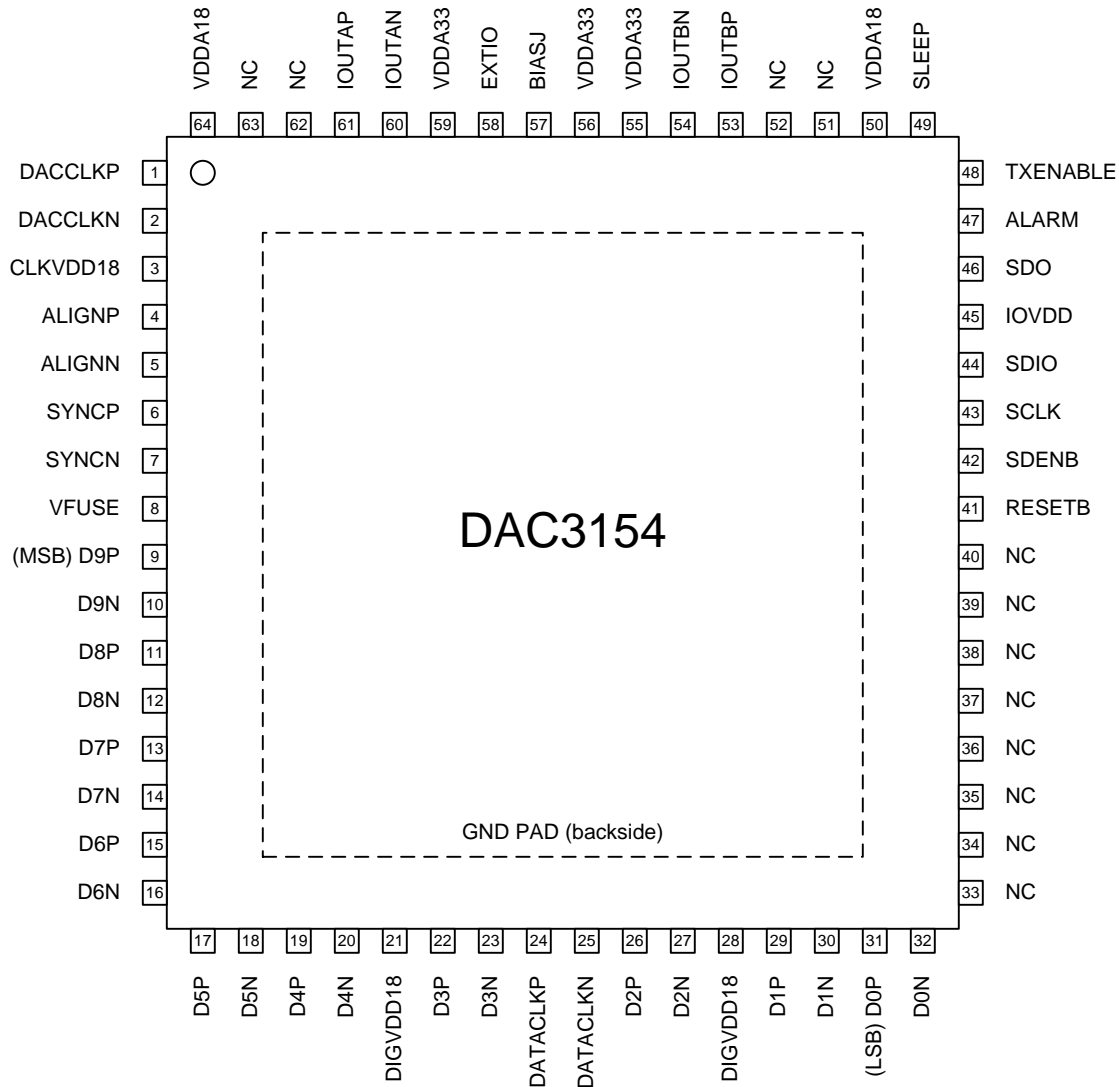

Figure 2. DAC3164

**PINOUT – DAC3154**



**PIN ASSIGNMENT TABLE – DAC3154**

PIN		I/O	DESCRIPTION
NAME	NO.		
<b>CONTROL/SERIAL</b>			
SCLK	43	I	Serial interface clock. Internal pull-down.
SDENB	42	I	Serial interface clock. Internal pull-up.
SDIO	44	I/O	Bi-directional serial data in 3 pin mode (default). In 4-pin interface mode (register XYZ), the SDIO pin in an input only. Internal Pull-down.
SDO	46	O	Uni-directional serial interface data in 4 pin mode (register XYZ). The SDO pin is tri-stated in 3-pin interface mode (default). Internal Pulldown.
RESETB	41	I	Serial interface reset input. Active low. Initialized internal registers during high to low transition. Assynchronous. Internal pull-up.
ALARM	47	O	CMOS output for ALARM condition.
TXENABLE	48	I	Transmit enable active high input. TXENABLE must be high for the DATA to the DAC to be enabled. When TXENABLE is low, the digital logic section is forced to all 0, and any input data is ignored. Internal pull-down.
SLEEP	49	I	Puts device in sleep, active high. Internal pull-down.

**PIN ASSIGNMENT TABLE – DAC3154 (continued)**

PIN		I/O	DESCRIPTION
NAME	NO.		
<b>DATA INTERFACE</b>			
DATA[9:0]P/N	9/10-19/20 22/23 26/27-31/32	I	LVDS input data bits for both channels. Each positive/negative LVDS pair has an internal 100 $\Omega$ termination resistor. Data format relative to DATACLKP/N clock is Double Data Rate (DDR) with two data transfers per DATAKP/N clock cycle.  The data format is interleaved with channel A (rising edge) and channel B falling edge.  In the default mode (reverse bus not enabled): DATA9P/N is most significant data bit (MSB) DATA0P/N is most significant data bit (LSB)
DATACLKP/N	24/25	I	DDR differential input data clock. Edge to center nominal timing. Ch A rising edge, Ch B falling edge in multiplexed output mode.
SYNCP/N	6/7	I	Reset the FIFO or to be used as a syncing source. These two functions are captured with the rising edge of DATACLKP/N. The signal captured by the falling edge of DATACLKP/N.
ALIGNP/N	4/5	I	LVPECL FIFO output synchronization. This positive/negative pair is captured with the rising edge of DACCLKP/N. It is used to reset the clock dividers and for multiple DAC synchronization. If unused it can be left unconnected.
<b>OUTPUT/CLOCK</b>			
DACCLKP/N	1/2	I	LVPECL clock input for DAC core with a self-bias of approximately CLKVDD18/2.
IOUTAP/N	61/60	O	A-Channel DAC current output. An offset binary data pattern of 0x0000 at the DAC input results in a full scale current source and the most positive voltage on the IOUTAP pin. Similarly, a 0xFFFF data input results in a 0 mA current source and the least positive voltage on the IOUTAP pin.
IOUTBP/N	53/54	O	B-Channel DAC current output. An offset binary data pattern of 0x0000 at the DAC input results in a full scale current source and the most positive voltage on the IOUTBP pin. Similarly, a 0xFFFF data input results in a 0 mA current source and the least positive voltage on the IOUTBP pin.
<b>REFERENCE</b>			
EXTIO	58	I/O	Used as external reference input when internal reference is disabled. Requires a 0.1 $\mu$ F decoupling capacitor to GND when used as reference output.
BIASJ	57	O	Full-scale output current bias. For 20 mA full-scale output current, connect a 960 $\Omega$ resistor to GND.
<b>POWER SUPPLY</b>			
IOVDD	45	I	Supply voltage for CMOS IO's. 1.8V – 3.3V.
CLKVDD18	3	I	1.8V clock supply
DIGVDD18	21, 28	I	1.8V digital supply. Also supplies LVDS receivers.
VDDA18	50, 64	I	Analog 1.8V supply
VDDA33	55, 56, 59	I	Analog 3.3V supply
VFUSE	8	I	Digital supply voltage. (1.8V) This supply pin is also used for factory fuse programming. Connect to DVDD pins for normal operation.
NC	33-40, 51, 52, 62, 63		Not used. These pins can be left open or tied to GROUND in actual application use.

**PINOUT – DAC3164**

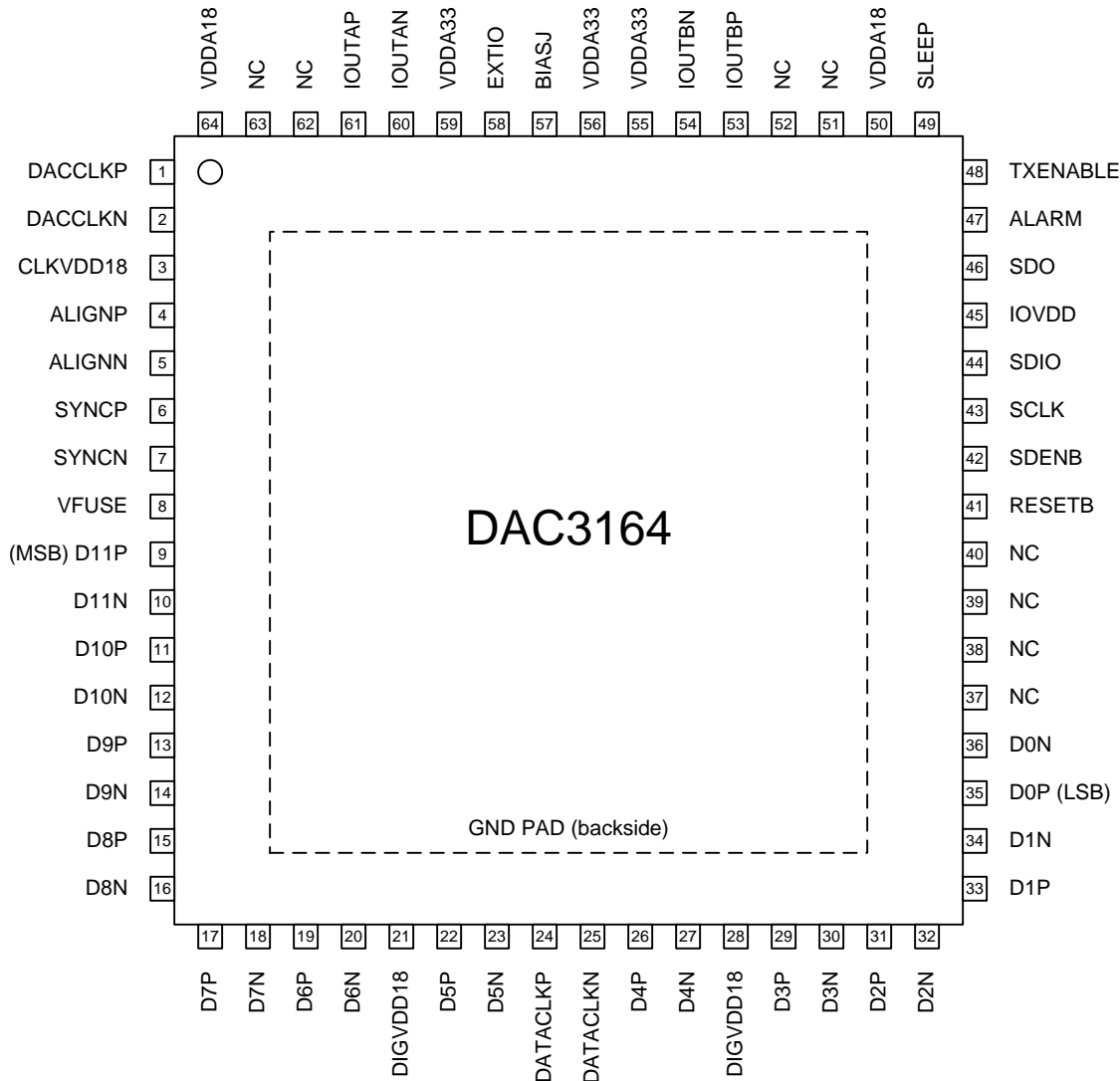

**PIN ASSIGNMENT TABLE – DAC3164**

PIN		I/O	DESCRIPTION
NAME	NO.		
<b>CONTROL/SERIAL</b>			
SCLK	43	I	Serial interface clock. Internal pull-down.
SDENB	42	I	Serial interface clock. Internal pull-up.
SDIO	44	I/O	Bi-directional serial data in 3 pin mode (default). In 4-pin interface mode (register XYZ), the SDIO pin in an input only. Internal Pull-down.
SDO	46	O	Uni-directional serial interface data in 4 pin mode (register XYZ). The SDO pin is tri-stated in 3-pin interface mode (default). Internal Pulldown.
RESETB	41	I	Serial interface reset input. Active low. Initialized internal registers during high to low transition. Assynchronous. Internal pull-up.
ALARM	47	O	CMOS output for ALARM condition.
TXENABLE	48	I	Transmit enable active high input. TXENABLE must be high for the DATA to the DAC to be enabled. When TXENABLE is low, the digital logic section is forced to all 0, and any input data is ignored. Internal pull-down.
SLEEP	49	I	Puts device in sleep, active high. Internal pull-down.

**PIN ASSIGNMENT TABLE – DAC3164 (continued)**

PIN		I/O	DESCRIPTION
NAME	NO.		
<b>DATA INTERFACE</b>			
DATA[11:0]P/N	9/10-19/20 22/23, 26-27- 35/36	I	LVDS input data bits for both channels. Each positive/negative LVDS pair has an internal 100 Ω termination resistor. Data format relative to DATACLKP/N clock is Double Data Rate (DDR) with two data transfers per DATAKP/N clock cycle.  The data format is interleaved with channel A (rising edge) and channel B falling edge.  In the default mode (reverse bus not enabled): DATA11P/N is most significant data bit (MSB) DATA0P/N is most significant data bit (LSB)
DATACLK[0]P/N	24/25	I	DDR differential input data clock. Edge to center nominal timing. Ch A rising edge, Ch B falling edge in multiplexed output mode.
SYNCP/N	6/7	I	Reset the FIFO or to be used as a syncing source. These two functions are captured with the rising edge of DATACLKP/N. The signal captured by the falling edge of DATACLKP/N.
ALIGNP/N	24/25	I	LVPECL FIFO output synchronization. This positive/negative pair is captured with the rising edge of DACCLKP/N. It is used to reset the clock dividers and for multiple DAC synchronization. If unused it can be left unconnected.
<b>OUTPUT/CLOCK</b>			
DACCLKP/N	1/2	I	LVPECL clock input for DAC core with a self-bias of approximately CLKVDD18/2.
IOUTAP/N	61/60	O	A-Channel DAC current output. An offset binary data pattern of 0x0000 at the DAC input results in a full scale current source and the most positive voltage on the IOUTA1 pin. Similarly, a 0xFFFF data input results in a 0 mA current source and the least positive voltage on the IOUTA1 pin. The IOUTA2 pin is the complement of IOUTA1.
IOUTBP/N	53/54	O	B-Channel DAC current output. An offset binary data pattern of 0x0000 at the DAC input results in a full scale current source and the most positive voltage on the IOUTB1 pin. Similarly, a 0xFFFF data input results in a 0 mA current source and the least positive voltage on the IOUTB1 pin. The IOUTB2 pin is the complement of IOUTB1.
<b>REFERENCE</b>			
EXTIO	58	I/O	Used as external reference input when internal reference is disabled. Requires a 0.1 μF decoupling capacitor to GND when used as reference output.
BIASJ	57	O	Full-scale output current bias. For 20 mA full-scale output current, connect a 960 Ω resistor to GND.
<b>POWER SUPPLY</b>			
IOVDD	45	I	Supply voltage for CMOS IO's. 1.8V – 3.3V.
CLKVDD18	3	I	1.8V clock supply
DIGVDD18	21, 28	I	1.8V digital supply. Also supplies LVDS receivers.
VDDA18	50, 64	I	Analog 1.8V supply
VDDA33	55, 56, 59	I	Analog 3.3V supply
VFUSE	8	I	Digital supply voltage. (1.8V) This supply pin is also used for factory fuse programming. Connect to DVDD pins for normal operation.
NC	37, 38, 39, 40, 51, 52 62, 63		Not used. These pins can be left open or tied to GROUND in actual application use.

**PACKAGE/ORDERING INFORMATION<sup>(1)</sup>**

PRODUCT	PACKAGE-LEAD	PACKAGE DESIGNATOR	SPECIFIED TEMPERATURE RANGE	ECO PLAN	ORDERING NUMBER	TRANSPORT MEDIA	QUANTITY
DAC3154	QFN-64	RGC	–40°C to 85°C	GREEN (RoHS and no Sb/Br)	DAC3154IRGCT	Tape and Reel	250
					DAC3154IRGCR		2000
DAC3164					DAC3164IRGC25		25
					DAC3164IRGCT		250
					DAC3164IRGCR		2000

(1) For the most current package and ordering information, see the Package Option Addendum at the end of this document, or see the TI website at [www.ti.com](http://www.ti.com).

## ABSOLUTE MAXIMUM RATINGS

over operating free-air temperature range (unless otherwise noted)<sup>(1)</sup>

		VALUE	UNIT
Supply voltage	VDDA33 to GND	-0.5 to 4	V
	VDDA18 to GND	-0.5 to 2.3	
	CLKVDD18 to GND	-0.5 to 2.3	
	IOVDD to GND	-0.5 to 4	
	DIGVDD18 to GND	-0.5 to 2.3	
Terminal voltage range	CLKVDD18 to DIGVDD18	-0.5 to 0.5	V
	VDDA18 to DIGVDD18	-0.5 to 0.5	
	D[11..0]P, D[11..0]N, DATACLKP, DATACLKN, SYNCP, SYNCPN to GND	-0.5 to DIGVDD18 + 0.5	
	DACCLKP, DACCLKN, ALIGNP, ALIGNN	-0.5 to CLKVDD18 + 0.5	
	TXENABLE, ALARM, SDO, SDIO, SCLK, SDENB, RESETB to GND	-0.5 to IOVDD + 0.5	
	IOUTAP, IOUTAN, IOUTBP, IOUTBN to GND	-0.7 to 1.4	
	EXTIO, BIASJ to GND	-0.5 to VDDA33 + 0.5	
Storage temperature range		-65 to 150	°C
ESD, Human Body Model		2	kV

(1) Stresses beyond those listed under absolute maximum ratings may cause permanent damage to the device. These are stress ratings only and functional operation of these or any other conditions beyond those indicated under “recommended operating conditions” is not implied. Exposure to absolute-maximum-rated conditions for extended periods may affect device reliability.

## THERMAL INFORMATION

THERMAL METRIC <sup>(1)</sup>		DAC3174	UNITS
		QFN (64 PIN)	
$\theta_{JA}$	Junction-to-ambient thermal resistance	23.0	°C/W
$\theta_{JCTop}$	Junction-to-case (top) thermal resistance	7.6	
$\theta_{JB}$	Junction-to-board thermal resistance	2.8	
$\psi_{JT}$	Junction-to-top characterization parameter	0.1	
$\psi_{JB}$	Junction-to-board characterization parameter	2.8	
$\theta_{JCbott}$	Junction-to-case (bottom) thermal resistance	0.2	

(1) For more information about traditional and new thermal metrics, see the *IC Package Thermal Metrics* application report, [SPRA953](#).



## ELECTRICAL CHARACTERISTICS – DC SPECIFICATIONS

Typical values at  $T_A = 25^\circ\text{C}$ , full temperature range is  $T_{\text{MIN}} = -40^\circ\text{C}$  to  $T_{\text{MAX}} = 85^\circ\text{C}$ , DAC sample rate = 500MSPS, 50% clock duty cycle,  $V_{\text{DDA33}}/\text{IOVDD} = 3.3\text{V}$ ,  $V_{\text{DDA18}}/\text{CLKVDD18}/\text{DIGVDD18} = 1.8\text{V}$ ,  $\text{IOUT}_{\text{FS}} = 20\text{mA}$  (unless otherwise noted).

PARAMETER	TEST CONDITIONS	DAC3154			DAC3164			UNIT	
		MIN	TYP	MAX	MIN	TYP	MAX		
<b>Resolution</b>		10			12			Bits	
<b>DC ACCURACY</b>									
DNL Differential nonlinearity	1 LSB = $\text{IOUT}_{\text{FS}}/2^{10}$ for DAC3154; 1 LSB = $\text{IOUT}_{\text{FS}}/2^{12}$ for DAC3164	$\pm 0.04$			$\pm 0.2$			LSB	
INL Integral nonlinearity		$\pm 0.15$			$\pm 0.5$				
<b>ANALOG OUTPUTS</b>									
Coarse gain linearity		$\pm 0.4$			$\pm 0.4$			LSB	
Offset error	Mid code offset	0.01			0.01			%FSR	
Gain error	With external reference	$\pm 2$			$\pm 2$			%FSR	
	With internal reference	$\pm 2$			$\pm 2$				
Gain mismatch	With internal reference	-2		2	-2		2	%FSR	
Minimum full scale output current	Nominal full-scale current, $\text{IOUT}_{\text{FS}} = 16 \times \text{IBIAS}$ current	2			2			mA	
Maximum full scale output current		20			20				
Output compliance range	$\text{IOUT}_{\text{FS}} = 20\text{ mA}$	-0.5			-0.5			1	V
Output resistance		300			300			k $\Omega$	
Output capacitance		5			5			pF	
<b>REFERENCE OUTPUT</b>									
$V_{\text{REF}}$	Reference output voltage	1.14	1.2	1.26	1.14	1.2	1.26	V	
	Reference output current	100			100			nA	
<b>REFERENCE INPUT</b>									
VEXTIO	Input voltage range	External reference mode	0.1	1.2	1.25	0.1	1.2	1.25	V
	Input resistance		1			1			M $\Omega$
	Small signal bandwidth		500			500			kHz
	Input capacitance		100			100			pF
<b>TEMPERATURE COEFFICIENTS</b>									
	Offset drift		$\pm 1$			$\pm 1$			ppm of FSR/ $^\circ\text{C}$
	Gain drift	With external reference	$\pm 15$			$\pm 15$			
		With internal reference	$\pm 30$			$\pm 30$			
	Reference voltage drift		$\pm 8$			$\pm 8$			ppm/ $^\circ\text{C}$
<b>POWER SUPPLY</b>									
	DIGVDD18, VFUSE, VDDA18, CLKVDD18		1.71	1.8		1.71	1.8	1.89	V
	VDDA33		3.15	3.3		3.15	3.3	3.45	V
	IOVDD	Sets CMOS IO voltage levels. Nominal 1.8V, 2.5V or 3.3V	1.71			1.71		3.45	V

**ELECTRICAL CHARACTERISTICS – DC SPECIFICATIONS (continued)**

Typical values at  $T_A = 25^\circ\text{C}$ , full temperature range is  $T_{\text{MIN}} = -40^\circ\text{C}$  to  $T_{\text{MAX}} = 85^\circ\text{C}$ , DAC sample rate = 500MSPS, 50% clock duty cycle,  $V_{\text{DDA33}}/\text{IOVDD} = 3.3\text{V}$ ,  $V_{\text{DDA18}}/\text{CLKVDD18}/\text{DIGVDD18} = 1.8\text{V}$ ,  $\text{IOUT}_{\text{FS}} = 20\text{mA}$  (unless otherwise noted).

PARAMETER	TEST CONDITIONS	DAC3154			DAC3164			UNIT			
		MIN	TYP	MAX	MIN	TYP	MAX				
<b>POWER CONSUMPTION</b>											
$I_{\text{VDDA33}}$	3.3V Analog supply current			52	59			52	59	mA	
$I_{\text{CLKVDD18}}$	1.8V Clock supply current			49	67			49	57	mA	
$I_{\text{DIGVDD18}}$	1.8V Digital supply current (DIGVDD18 and VFUSE)			115	130			115	130	mA	
$I_{\text{IOVDD}}$	1.8V IO Supply current			0.002	0.015			0.002	0.015	mA	
$P_{\text{dis}}$	Total power dissipation			464	530			464	530	mW	
<b>MODE 1</b> $f_{\text{DAC}} = 491.52\text{ MSPS}$ , QMC on, IF = 20 MHz											
$I_{\text{VDDA33}}$	3.3V Analog supply current			51				51		mA	
$I_{\text{CLKVDD18}}$	1.8V Clock supply current			38				38		mA	
$I_{\text{DIGVDD18}}$	1.8V Digital supply current (DIGVDD18 and VFUSE)			87				87		mA	
$I_{\text{IOVDD}}$	1.8V IO Supply current			0.002				0.002		mA	
$P_{\text{dis}}$	Total power dissipation			396				396		mW	
<b>MODE 2</b> $f_{\text{DAC}} = 320\text{ MSPS}$ , QMC on, IF = 20 MHz											
$I_{\text{VDDA33}}$	3.3V Analog supply current			2.6				2.6		mA	
$I_{\text{CLKVDD18}}$	1.8V Clock supply current			43				43		mA	
$I_{\text{DIGVDD18}}$	1.8V Digital supply current (DIGVDD18 and VFUSE)			110				110		mA	
$I_{\text{IOVDD}}$	1.8V IO Supply current			0.003				0.003		mA	
$P_{\text{dis}}$	Total power dissipation			284				284		mW	
<b>MODE 3</b> Sleep mode, $f_{\text{DAC}} = 491.52\text{ MSPS}$ , DAC in sleep mode											
$I_{\text{VDDA33}}$	3.3V Analog supply current			1.6	4			1.6	4	mA	
$I_{\text{CLKVDD18}}$	1.8V Clock supply current			1.8	4			1.8	4	mA	
$I_{\text{DIGVDD18}}$	1.8V Digital supply current (DIGVDD18 and VFUSE)				1.7				3	mA	
$I_{\text{IOVDD}}$	1.8V IO Supply current			0.003	0.015			0.003	0.015	mA	
$P_{\text{dis}}$	Total power dissipation			10	26			10	26	mW	
PSRR	Power supply rejection ratio	DC tested		-0.4		0.4		-0.4		0.4	%/FSR/V
T	Operating temperature			-40		85		-40		85	$^\circ\text{C}$

## ELECTRICAL CHARACTERISTICS – AC SPECIFICATIONS

Typical values at  $T_A = 25^\circ\text{C}$ , full temperature range is  $T_{\text{MIN}} = -40^\circ\text{C}$  to  $T_{\text{MAX}} = 85^\circ\text{C}$ , DAC sample rate = 500MSPS, 50% clock duty cycle,  $V_{\text{DDA33}}/\text{IOVDD} = 3.3\text{V}$ ,  $V_{\text{DDA18}}/\text{CLKVDD18}/\text{DIGVDD18} = 1.8\text{V}$ ,  $\text{IOUT}_{\text{FS}} = 20\text{mA}$  (unless otherwise noted).

PARAMETER	TEST CONDITIONS	DAC3154			DAC3164			UNIT
		MIN	TYP	MAX	MIN	TYP	MAX	
<b>ANALOG OUTPUT</b>								
$f_{\text{DAC}}$	Maximum sample rate	500			500			MSPS
$t_{\text{s(DAC)}}$	Output settling time to 0.1%	Transition: Code 0x0000 to 0x3FFF			11			ns
$t_{\text{PD}}$	Output propagation delay	Does not include digital latency			2			ns
$t_{\text{r(IOUT)}}$	Output rise time 10% to 90%				200			ps
$t_{\text{f(IOUT)}}$	Output fall time 90% to 10%				200			ps
	Digital Latency	Length of delay from DAC input pins to DATA at output pins. In normal operation mode including the latency of FIFO.			26			$\mu\text{s}$
<b>AC PERFORMANCE</b>								
SFDR	Spurious free dynamic range	$f_{\text{DAC}} = 500 \text{ MSPS}, f_{\text{out}} = 10.1 \text{ MHz}$			81			dBc
		$f_{\text{DAC}} = 500 \text{ MSPS}, f_{\text{out}} = 20.1 \text{ MHz}$			76			
		$f_{\text{DAC}} = 500 \text{ MSPS}, f_{\text{out}} = 70.1 \text{ MHz}$			69			
IMD3	Intermodulation distortion	$f_{\text{DAC}} = 500 \text{ MSPS}, f_{\text{out}} = 10.1 \pm 0.5 \text{ MHz}$			82			dBc
		$f_{\text{DAC}} = 500 \text{ MSPS}, f_{\text{out}} = 20.1 \pm 0.5 \text{ MHz}$			81			
		$f_{\text{DAC}} = 500 \text{ MSPS}, f_{\text{out}} = 70.1 \pm 0.5 \text{ MHz}$			73.5			
		$f_{\text{DAC}} = 500 \text{ MSPS}, f_{\text{out}} = 150.1 \pm 0.5 \text{ MHz}$			61			
NSD	Noise spectral density	$f_{\text{DAC}} = 500 \text{ MSPS}, f_{\text{out}} = 10.1 \text{ MHz}$			147			dBc/Hz
		$f_{\text{DAC}} = 500 \text{ MSPS}, f_{\text{out}} = 20.1 \text{ MHz}$			146			
		$f_{\text{DAC}} = 500 \text{ MSPS}, f_{\text{out}} = 70.1 \text{ MHz}$			146			
ACLR	Adjacent channel leakage ratio	$f_{\text{DAC}} = 491.52 \text{ MSPS}, f_{\text{out}} = 30.72 \text{ MHz}, \text{WCDMA TM1}$			69			dBc
		$f_{\text{AC}} = 491.52 \text{ MSPS}, f_{\text{out}} = 153.6 \text{ MHz}, \text{WCDMA TM1}$			68			
	Channel isolation	$f_{\text{DAC}} = 500 \text{ MSPS}, f_{\text{out}} = 20 \text{ MHz}$			90			dBc

## ELECTRICAL CHARACTERISTICS – DIGITAL SPECIFICATIONS

Typical values at  $T_A = 25^\circ\text{C}$ , full temperature range is  $T_{\text{MIN}} = -40^\circ\text{C}$  to  $T_{\text{MAX}} = 85^\circ\text{C}$ , DAC sample rate = 500MSPS, 50% clock duty cycle,  $V_{\text{DDA33}}/\text{IOVDD} = 3.3\text{V}$ ,  $V_{\text{DDA18}}/\text{CLKVDD18}/\text{DIGVDD18} = 1.8\text{V}$ ,  $\text{IOUT}_{\text{FS}} = 20\text{mA}$  (unless otherwise noted).

PARAMETERS	TEST CONDITIONS	DAC3154			DAC3164			UNIT	
		MIN	TYP	MAX	MIN	TYP	MAX		
<b>CMOS DIGITAL INPUTS (RESETB, SDENB, SCLK, SDIO, TXENABLE)</b>									
$V_{\text{IH}}$	High-level input voltage	IOVDD = 3.3 V, 2.5 V or 1.8 V	0.6x IOVDD		0.6x IOVDD		V		
$V_{\text{IL}}$	Low-level input voltage		0.25x IOVDD		0.25x IOVDD		V		
$I_{\text{IH}}$	High-level input current		-40	40	-40	40	$\mu\text{A}$		
$I_{\text{IL}}$	Low-level input current		-40	40	-40	40	$\mu\text{A}$		
<b>DIGITAL OUTPUTS – CMOS INTERFACE (SDOUT, SDIO)</b>									
$V_{\text{OH}}$	High-level output voltage	IOVDD = 3.3 V, 2.5 V, or 1.8 V	0.85x IOVDD		0.85x IOVDD		V		
$V_{\text{OL}}$	Low-level output voltage		0.125x IOVDD		0.125x IOVDD		V		
<b>SERIAL PORT TIMING</b>									
$t_{\text{s}}(\text{SDENB})$	Setup time, SDENB to rising edge of SCLK		20		20		ns		
$t_{\text{s}}(\text{SDIO})$	Setup time, SDIO to rising edge of SCLK		10		10		ns		
$t_{\text{h}}(\text{SDIO})$	Hold time, SDIO from rising edge of SCLK		5		5		ns		
$t_{\text{p}}(\text{SCLK})$	Period of SCLK		100		100		ns		
$t_{\text{h}}(\text{SCLKH})$	High time of SCLK		40		40		ns		
$t_{\text{l}}(\text{SCLKL})$	Low time of SCLK		40		40		ns		
$t_{\text{d}}(\text{DATA})$	Data output delay after falling edge of SCLK		10		10		ns		
$T_{\text{RESET}}$	Minimum RESTB pulsewidth								
<b>LVDS INTERFACE (D[x..0]P/N, DA[x..0]P/N, DB[x..0]P/N, DA_CLKP/N, DB_CLKP/N, DATA_CLKP/N, SYNC P/N, ALIGN P/N)</b>									
$V_{\text{A,B+}}$	Logic high differential input voltage threshold		175		175		mV		
$V_{\text{A,B-}}$	Logic low differential input voltage threshold		-175		-175		mV		
$V_{\text{COM}}$	Input Common Mode Range		1.0	1.2	2.0	1.0	1.2	2.0	V
$Z_{\text{T}}$	Internal termination		85	110	135	85	110	135	$\Omega$
$C_{\text{L}}$	LVDS input capacitance		2		2		pF		

**ELECTRICAL CHARACTERISTICS – DIGITAL SPECIFICATIONS (continued)**

Typical values at  $T_A = 25^\circ\text{C}$ , full temperature range is  $T_{\text{MIN}} = -40^\circ\text{C}$  to  $T_{\text{MAX}} = 85^\circ\text{C}$ , DAC sample rate = 500MSPS, 50% clock duty cycle, VDDA33/IOVDD = 3.3V, VDDA18/CLKVDD18/DIGVDD18 = 1.8V,  $\text{IOUT}_{\text{FS}} = 20\text{mA}$  (unless otherwise noted).

PARAMETERS		TEST CONDITIONS		DAC3154			DAC3164			UNIT
				MIN	TYP	MAX	MIN	TYP	MAX	
<b>LVDS INPUT TIMING: SINGLE BUS SINGLE CLOCK MODE</b>										
$t_{\text{s(DATA)}}$	Setup time	D[x..0] valid to DATACLK rising or falling edge	config3 Setting							ps
			datadly	clkdly						
			0	0	-20		-20			
			0	1	-120		-120			
			0	2	-220		-220			
			0	3	-310		-310			
			0	4	-390		-390			
			0	5	-480		-480			
			0	6	-560		-560			
			0	7	-630		-630			
			1	0	70		70			
			2	0	150		150			
			3	0	230		230			
			4	0	330		330			
			5	0	430		430			
			6	0	530		530			
7	0	620		620						
$t_{\text{h(DATA)}}$	Hold time	D[x..0] valid to DATACLK rising or falling edge	config3 Setting							ps
			datadly	clkdly						
			0	0	310		310			
			0	1	390		390			
			0	2	480		480			
			0	3	560		560			
			0	4	650		650			
			0	5	740		740			
			0	6	850		850			
			0	7	930		930			
			1	0	200		200			
			2	0	100		100			
			3	0	20		20			
			4	0	-60		-60			
			5	0	-140		-140			
			6	0	-220		-220			
7	0	-290		-290						

TYPICAL CHARACTERISTICS

All plots are at 25°C, nominal supply voltages,  $f_{DAC} = 500\text{MSPS}$ , 50% clock duty cycle, 0-dBFS input signal and 20mA full-scale output current (unless otherwise noted).

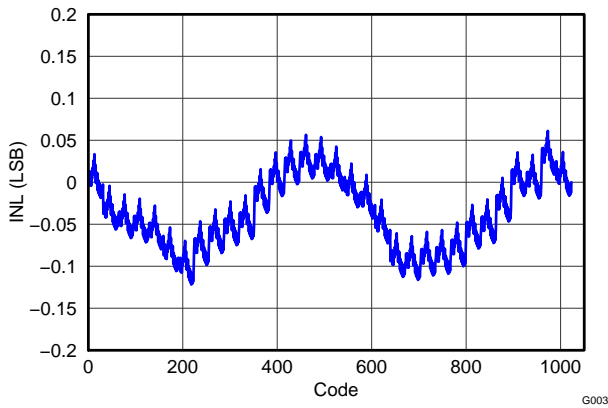

Figure 3. DAC3154 Integral Nonlinearity

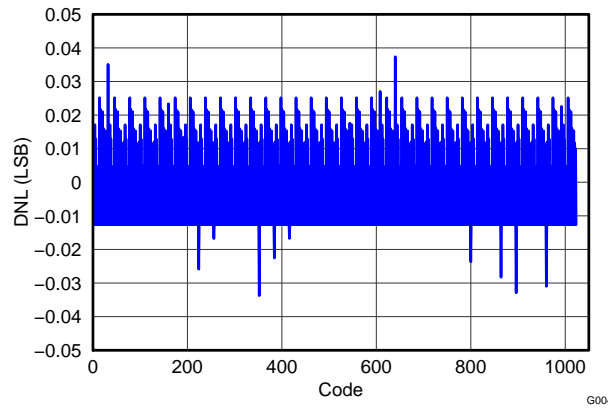

Figure 4. DAC3154 Differential Nonlinearity

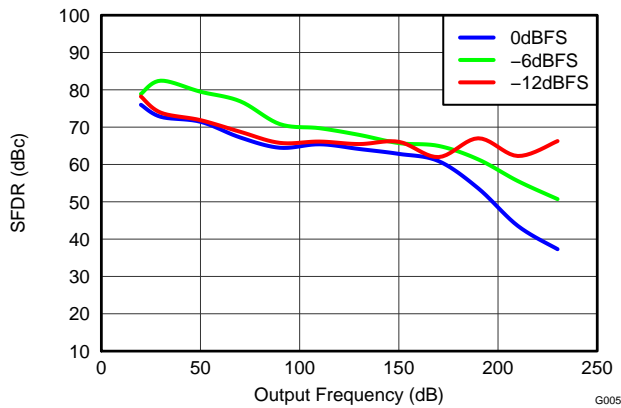

Figure 5. DAC3154 SFDR vs Output Frequency Over Input Scale

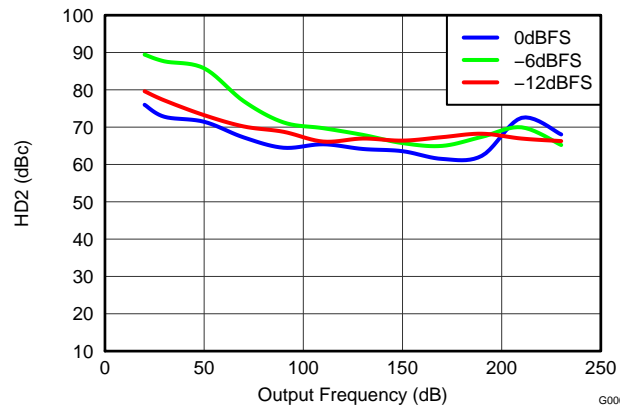

Figure 6. DAC3154 Second-Order Harmonic Distortion vs Output Frequency Over Input Scale

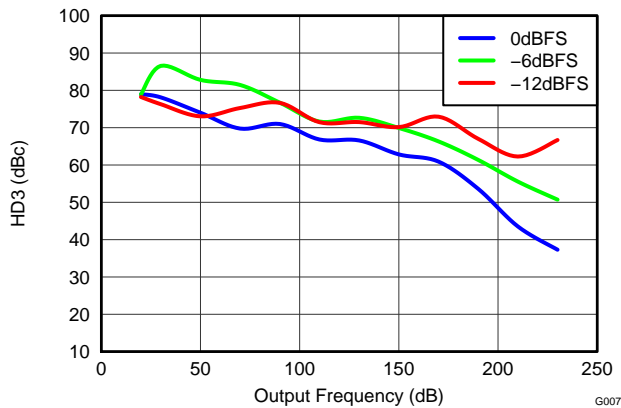

Figure 7. DAC3154 Third-Order Harmonic Distortion vs Output Frequency Over Input Scale

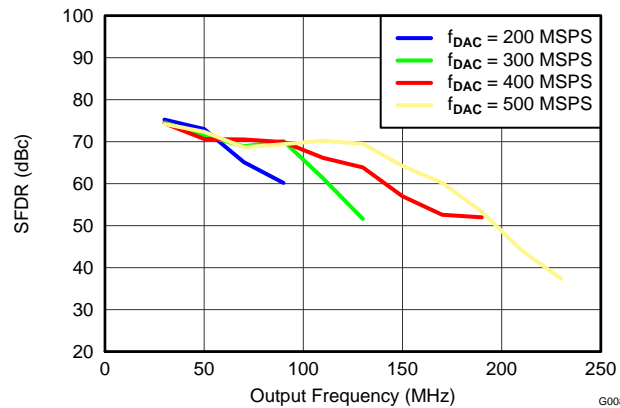

Figure 8. DAC3154 SFDR vs Output Frequency Over  $f_{DAC}$

**TYPICAL CHARACTERISTICS (continued)**

All plots are at 25°C, nominal supply voltages,  $f_{DAC} = 500\text{MSPS}$ , 50% clock duty cycle, 0-dBFS input signal and 20mA full-scale output current (unless otherwise noted).

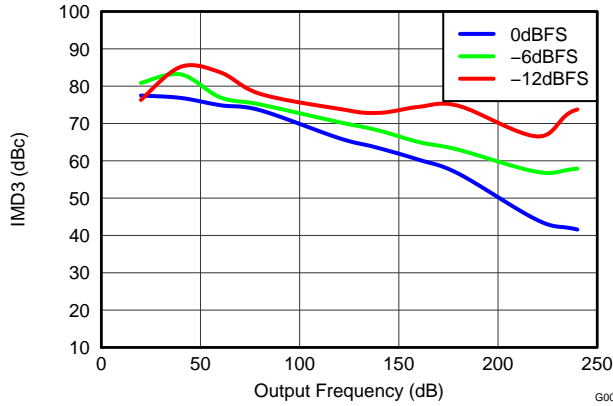

Figure 9. DAC3154 IMD3 vs Output Frequency Over Input Scale

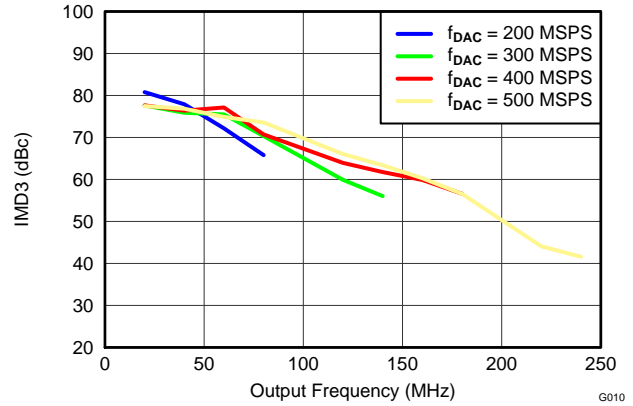

Figure 10. DAC3154 IMD3 vs Output Frequency Over  $f_{DAC}$

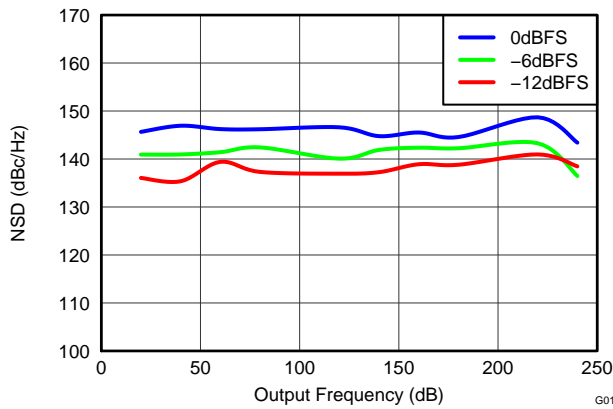

Figure 11. DAC3154 NSD vs Output Frequency Over Input Scale

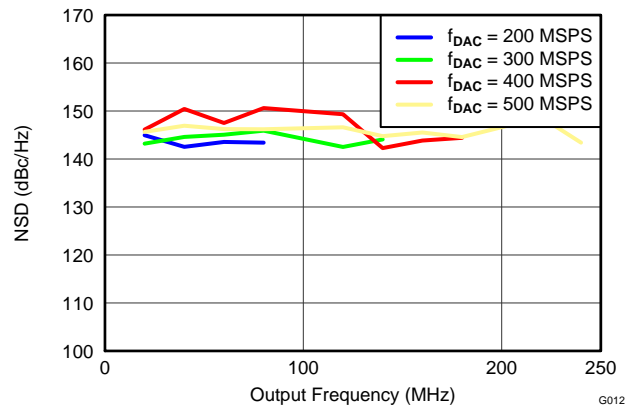

Figure 12. DAC3154 NSD vs Output Frequency Over  $f_{DAC}$

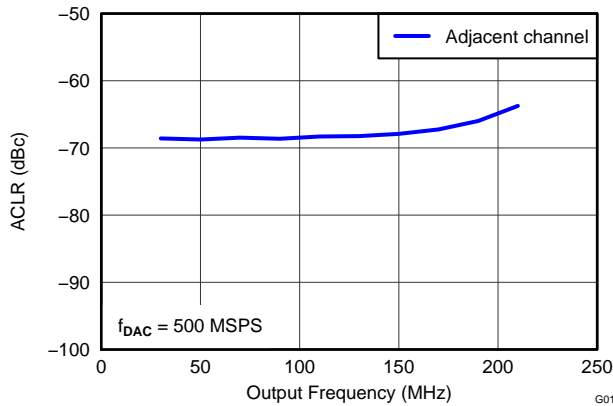

Figure 13. DAC3154 ACLR (Adjacent Channel) vs Output Frequency

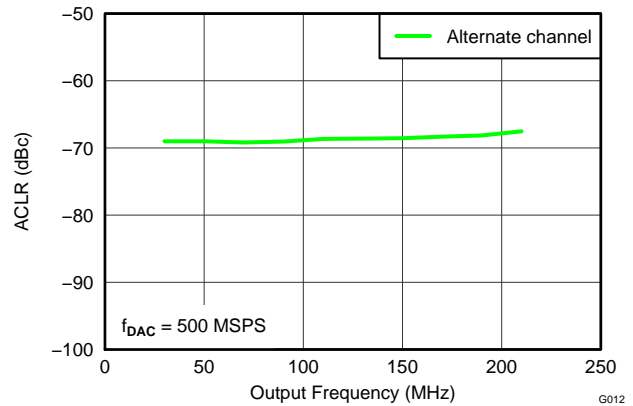

Figure 14. DAC3154 ACLR (Alternate Channel) vs Output Frequency

**TYPICAL CHARACTERISTICS (continued)**

All plots are at 25°C, nominal supply voltages,  $f_{DAC} = 500\text{MSPS}$ , 50% clock duty cycle, 0-dBFS input signal and 20mA full-scale output current (unless otherwise noted).

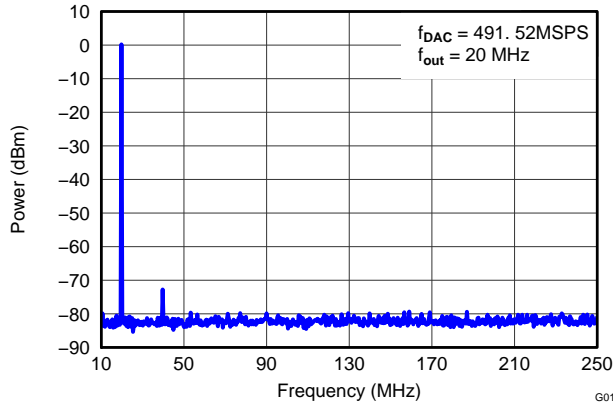

Figure 15. DAC3154 Single-Tone Spectral Plot (IF = 20MHz)

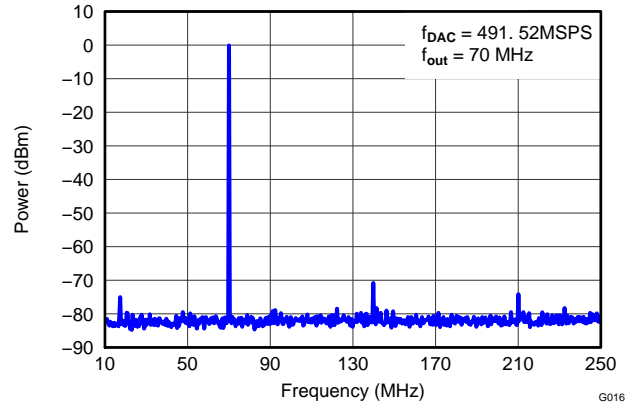

Figure 16. DAC3154 Single-Tone Spectral Plot (IF = 70MHz)

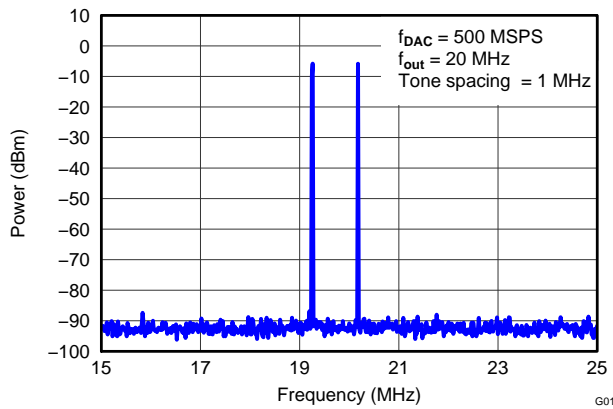

Figure 17. DAC3154 Two-Tone Spectral Plot (IF = 20MHz)

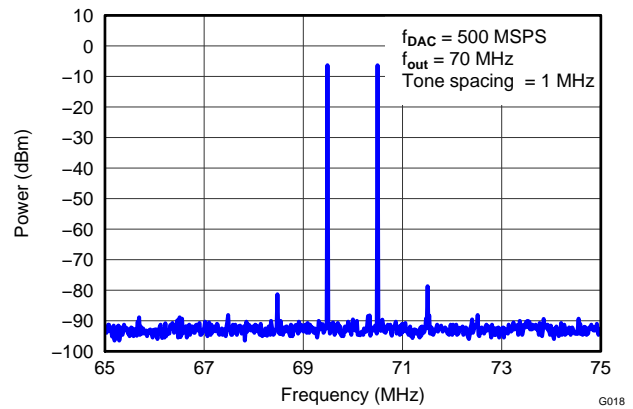

Figure 18. DAC3154 Two-Tone Spectral Plot (IF = 70MHz)

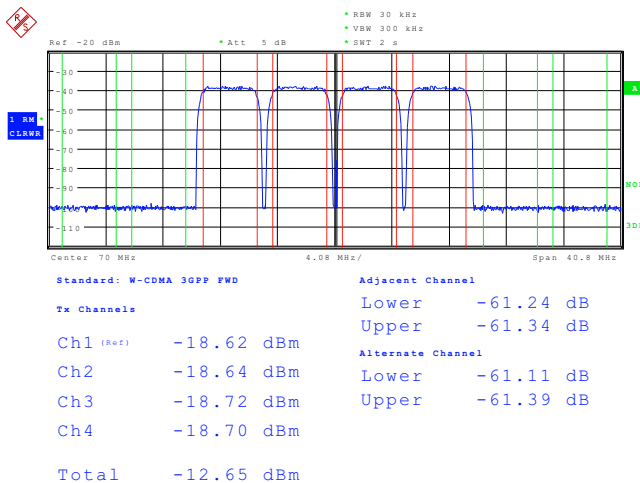

Figure 19. DAC3154 ACPR Four-Carrier WCDMA Test Mode 1

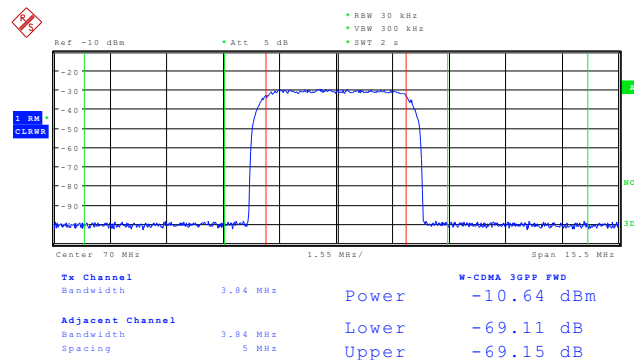
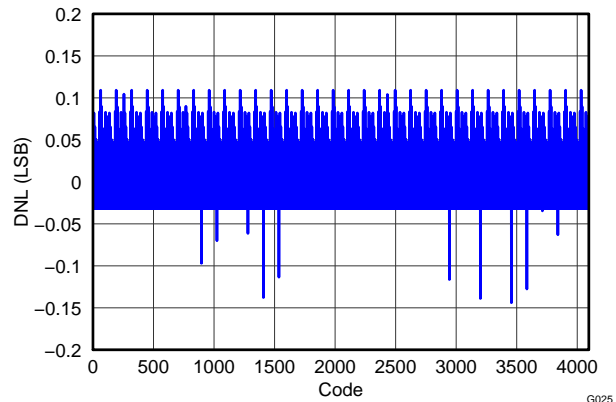
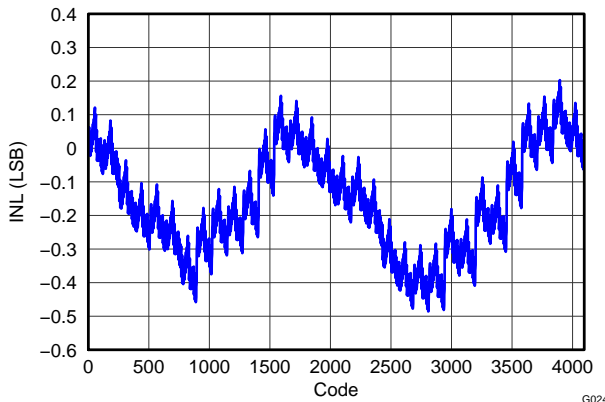
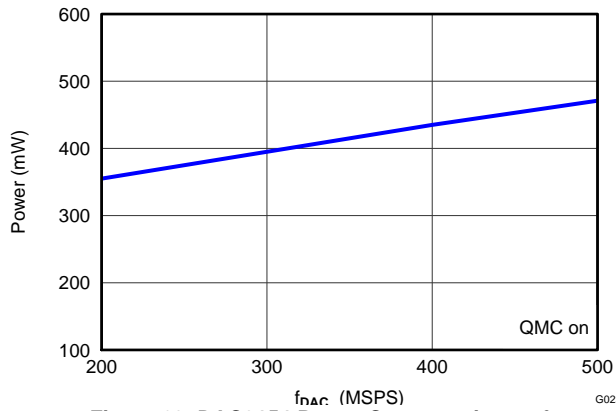
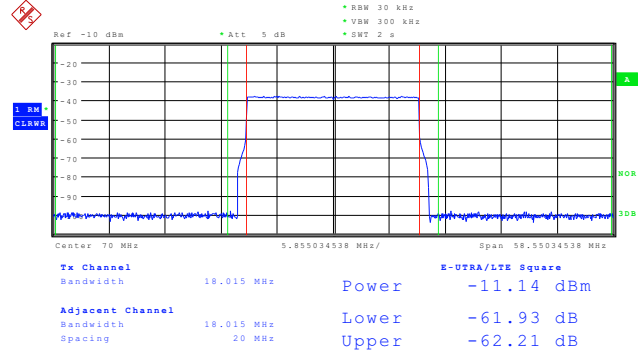
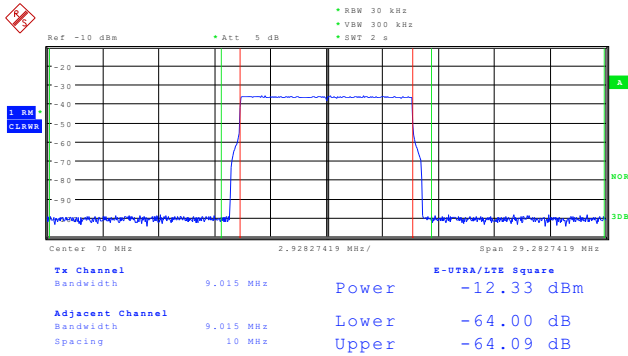

Figure 20. DAC3154 ACPR Single-Carrier WCDMA Test Mode 1



**TYPICAL CHARACTERISTICS (continued)**

All plots are at 25°C, nominal supply voltages,  $f_{DAC} = 500\text{MSPS}$ , 50% clock duty cycle, 0-dBFS input signal and 20mA full-scale output current (unless otherwise noted).



**TYPICAL CHARACTERISTICS (continued)**

All plots are at 25°C, nominal supply voltages,  $f_{DAC} = 500\text{MSPS}$ , 50% clock duty cycle, 0-dBFS input signal and 20mA full-scale output current (unless otherwise noted).

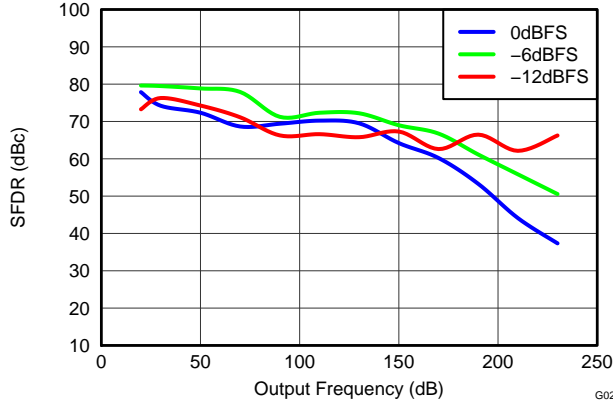

Figure 26. DAC3164 SFDR vs Output Frequency Over Input Scale

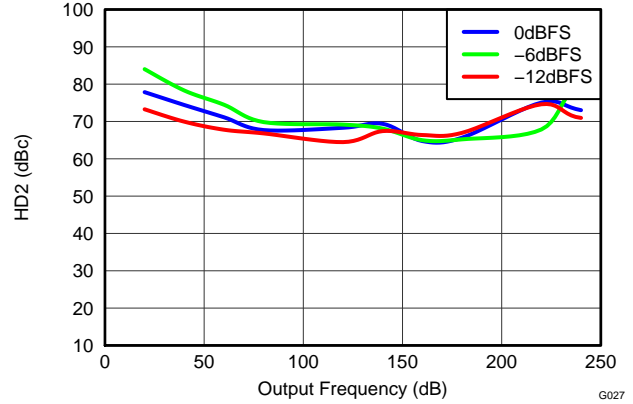

Figure 27. DAC3164 Second-Order Harmonic Distortion vs Output Frequency Over Input Scale

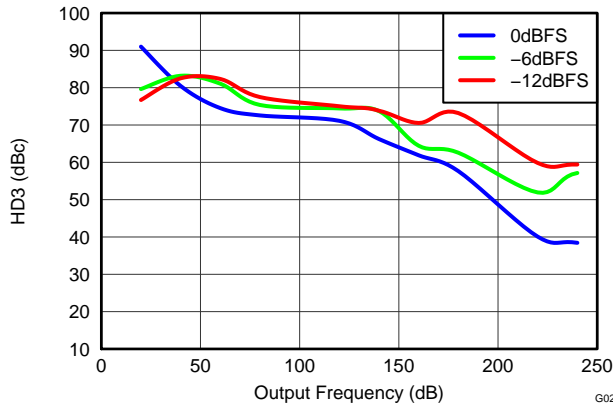

Figure 28. DAC3164 Third-Order Harmonic Distortion vs Output Frequency Over Input Scale

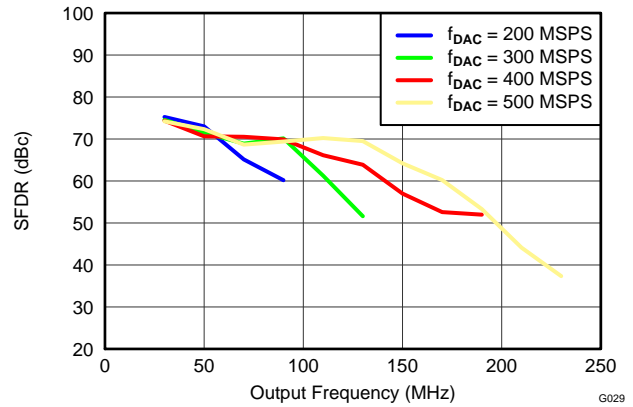

Figure 29. DAC3164 SFDR vs Output Frequency Over  $f_{DAC}$

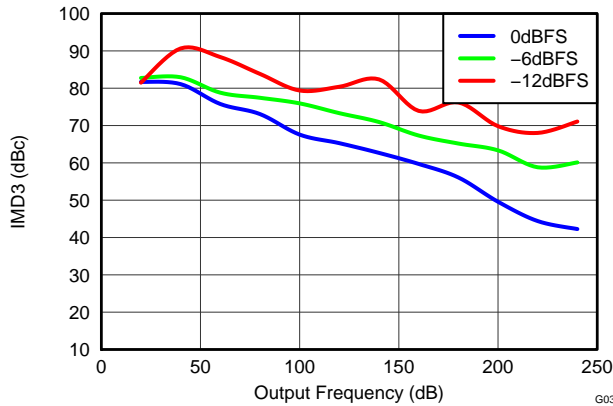

Figure 30. DAC3164 IMD3 vs Output Frequency Over Input Scale

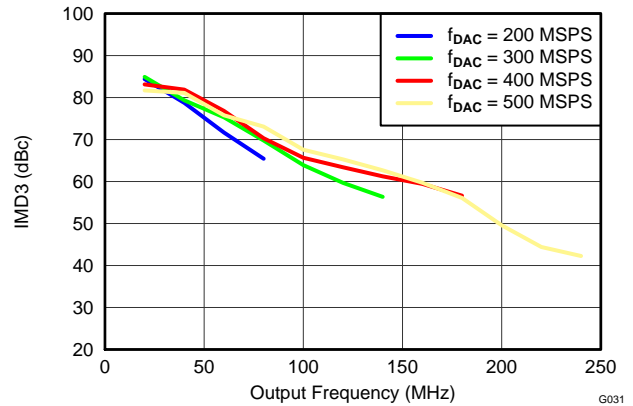

Figure 31. DAC3164 IMD3 vs Output Frequency Over  $f_{DAC}$

TYPICAL CHARACTERISTICS (continued)

All plots are at 25°C, nominal supply voltages,  $f_{DAC} = 500\text{MSPS}$ , 50% clock duty cycle, 0-dBFS input signal and 20mA full-scale output current (unless otherwise noted).

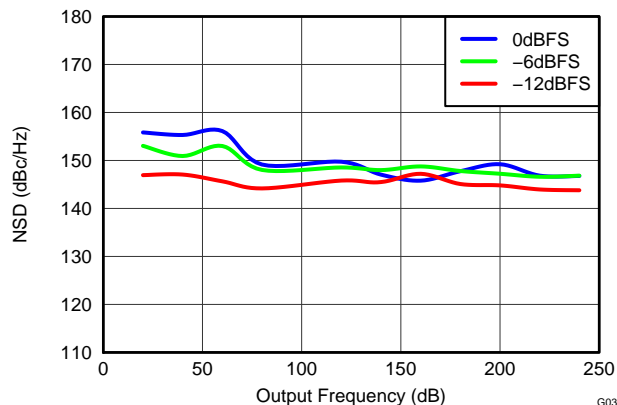

Figure 32. DAC3164 NSD vs Output Frequency Over Input Scale

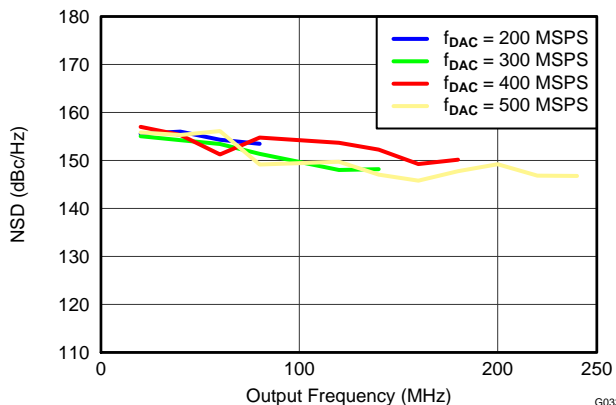

Figure 33. DAC3164 NSD vs Output Frequency Over  $f_{DAC}$

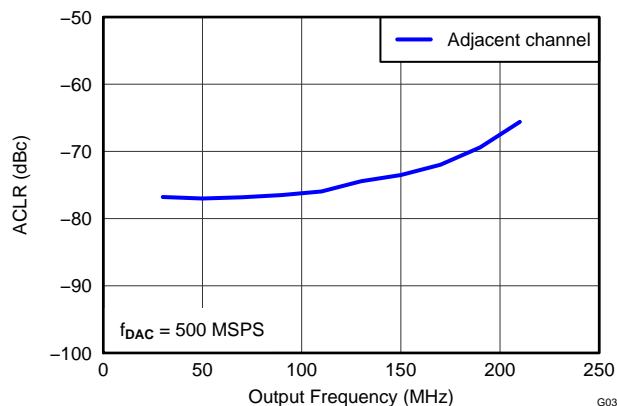

Figure 34. DAC3164 ACLR (Adjacent Channel) vs Output Frequency

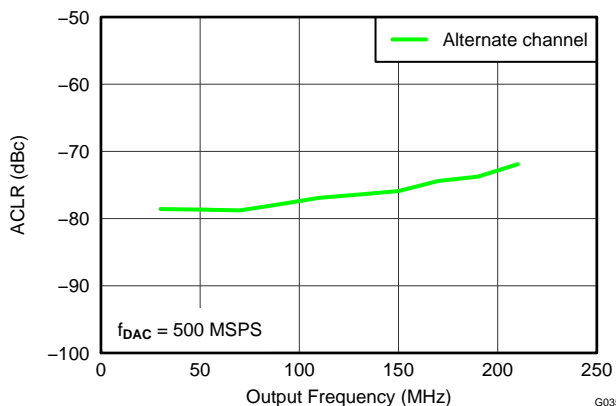

Figure 35. DAC3164 ACLR (Alternate Channel) vs Output Frequency

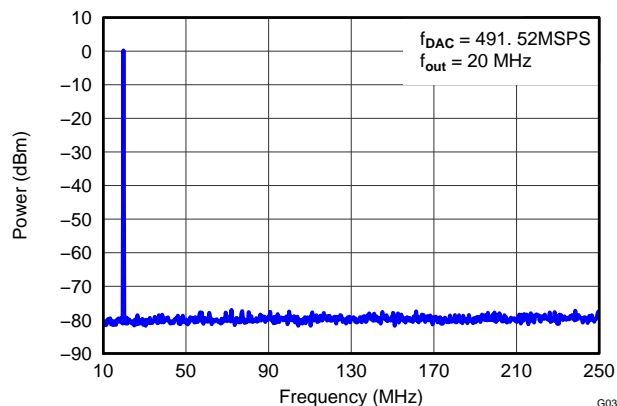

Figure 36. DAC3164 Single-Tone Spectral Plot (IF = 20MHz)

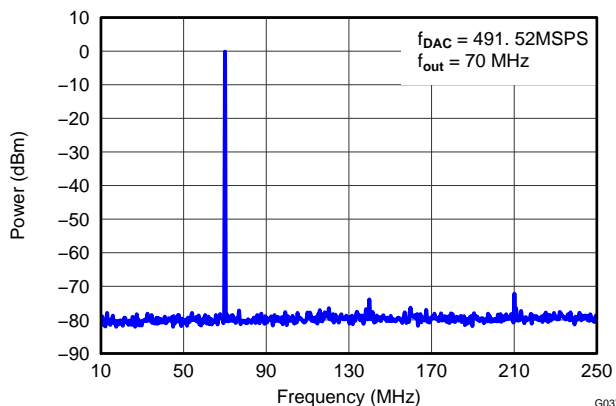

Figure 37. DAC3164 Single-Tone Spectral Plot (IF = 70MHz)

**TYPICAL CHARACTERISTICS (continued)**

All plots are at 25°C, nominal supply voltages,  $f_{DAC} = 500\text{MSPS}$ , 50% clock duty cycle, 0-dBFS input signal and 20mA full-scale output current (unless otherwise noted).

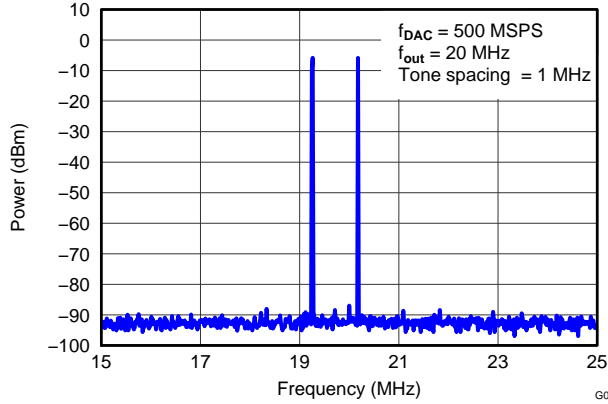

Figure 38. DAC3164 Two-Tone Spectral Plot (IF = 20MHz)

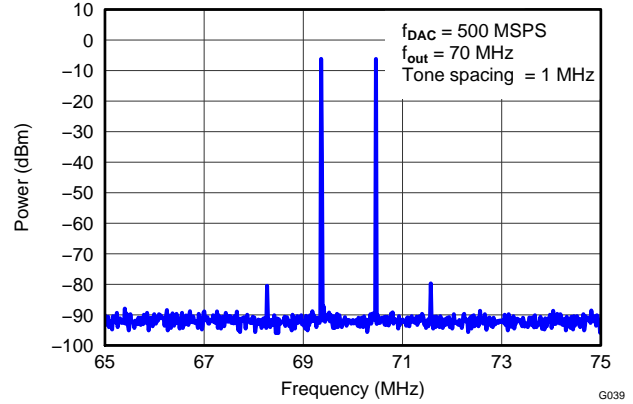

Figure 39. DAC3164 Two-Tone Spectral Plot (IF = 70MHz)

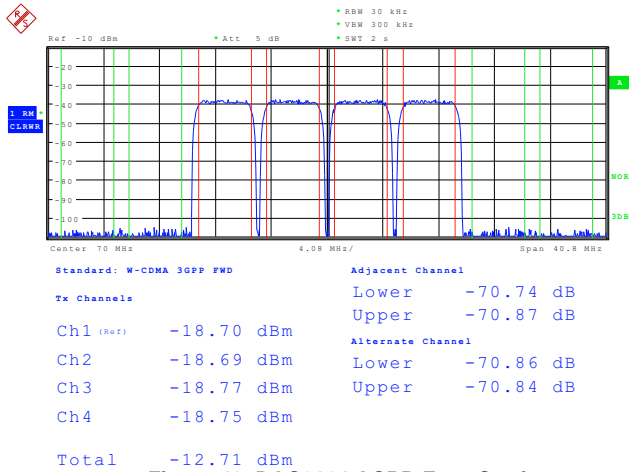

Figure 40. DAC3164 ACPR Four-Carrier WCDMA Test Mode 1

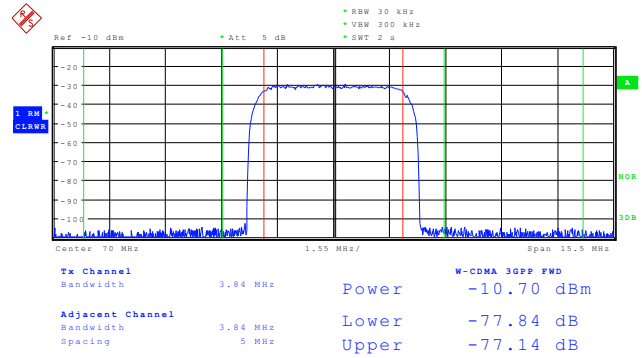

Figure 41. DAC3164 ACPR Single-Carrier WCDMA Test Mode 1

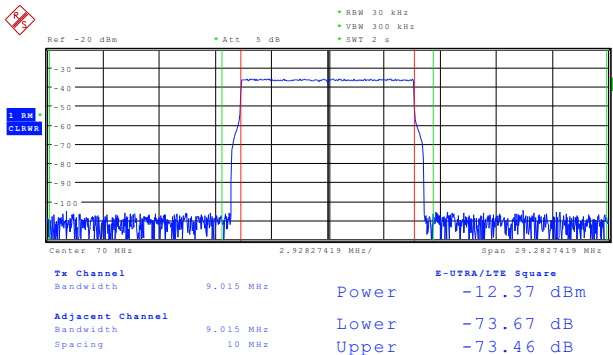

Figure 42. DAC3164 ACPR LTE 10-MHz FDD E-TM 1.1

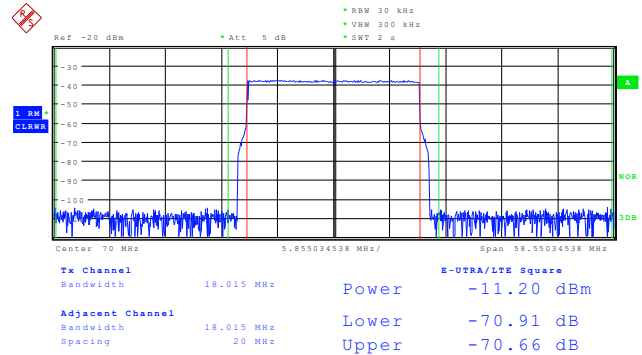
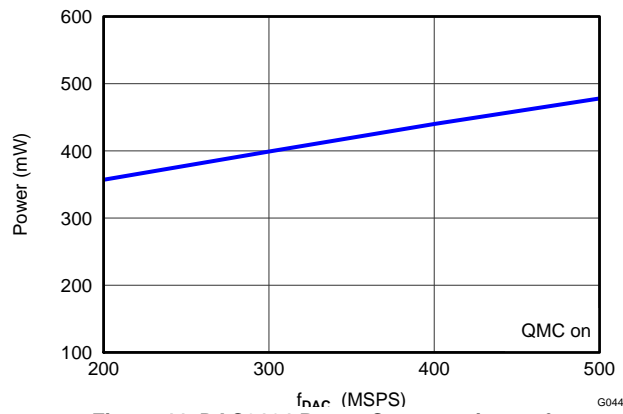

Figure 43. DAC3164 ACPR LTE 20-MHz FDD E-TM 1.1

**TYPICAL CHARACTERISTICS (continued)**

All plots are at 25°C, nominal supply voltages,  $f_{DAC} = 500\text{MSPS}$ , 50% clock duty cycle, 0-dBFS input signal and 20mA full-scale output current (unless otherwise noted).



**Figure 44. DAC3164 Power Consumption vs  $f_{DAC}$**

## DEFINITION OF SPECIFICATIONS

**Adjacent Carrier Leakage Ratio (ACLR):** Defined as the ratio in decibel relative to the carrier (dBc) between the measured power within the channel and that of its adjacent channel.

**Analog and Digital Power Supply Rejection Ratio (APSSR, DPSSR):** Defined as the percentage error in the ratio of the delta IOOUT and delta supply voltage normalized with respect to the ideal IOOUT current.

**Differential Nonlinearity (DNL):** Defined as the variation in analog output associated with an ideal 1 LSB change in the digital input code.

**Gain Drift:** Defined as the maximum change in gain, in terms of ppm of full-scale range (FSR) per °C, from the value at ambient (25°C) to values over the full operating temperature range.

**Gain Error:** Defined as the percentage error (in FSR%) for the ratio between the measured full-scale output current and the ideal full-scale output current.

**Integral Nonlinearity (INL):** Defined as the maximum deviation of the actual analog output from the ideal output, determined by a straight line drawn from zero scale to full scale.

**Intermodulation Distortion (IMD3):** The two-tone IMD3 is defined as the ratio (in dBc) of the 3rd-order intermodulation distortion product to either fundamental output tone.

**Offset Drift:** Defined as the maximum change in DC offset, in terms of ppm of full-scale range (FSR) per °C, from the value at ambient (25°C) to values over the full operating temperature range.

**Offset Error:** Defined as the percentage error (in FSR%) for the ratio between the measured mid-scale output current and the ideal mid-scale output current.

**Output Compliance Range:** Defined as the minimum and maximum allowable voltage at the output of the current-output DAC. Exceeding this limit may result reduced reliability of the device or adversely affecting distortion performance.

**Reference Voltage Drift:** Defined as the maximum change of the reference voltage in ppm per degree Celsius from value at ambient (25°C) to values over the full operating temperature range.

**Spurious Free Dynamic Range (SFDR):** Defined as the difference (in dBc) between the peak amplitude of the output signal and the peak spurious signal.

**Signal to Noise Ratio (SNR):** Defined as the ratio of the RMS value of the fundamental output signal to the RMS sum of all other spectral components below the Nyquist frequency, including noise, but excluding the first six harmonics and dc.

## TIMING DIAGRAMS

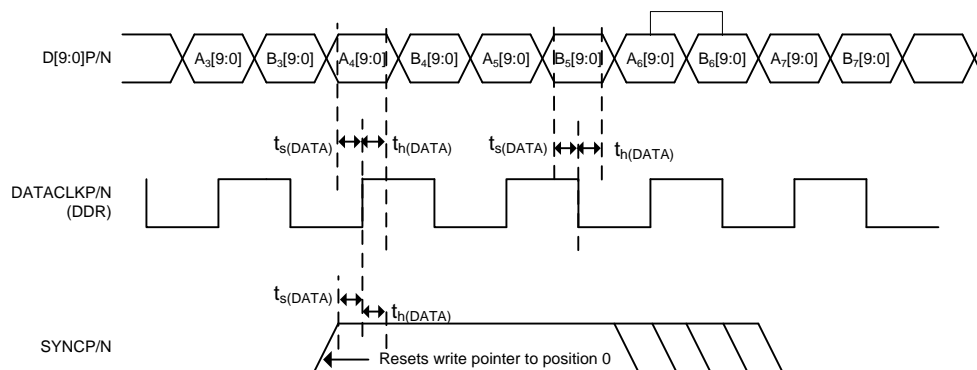

Figure 45. DAC3154 Input Timing Diagram for Dual Channel DDR Mode

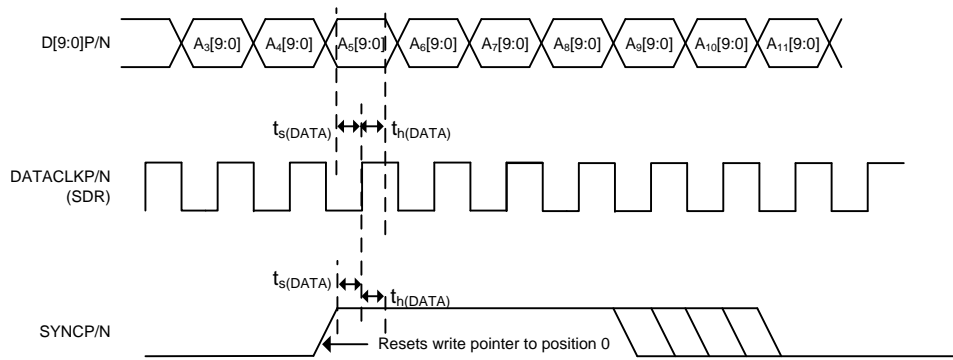

Figure 46. DAC3154 Input Timing Diagram for Single Channel SDR Mode

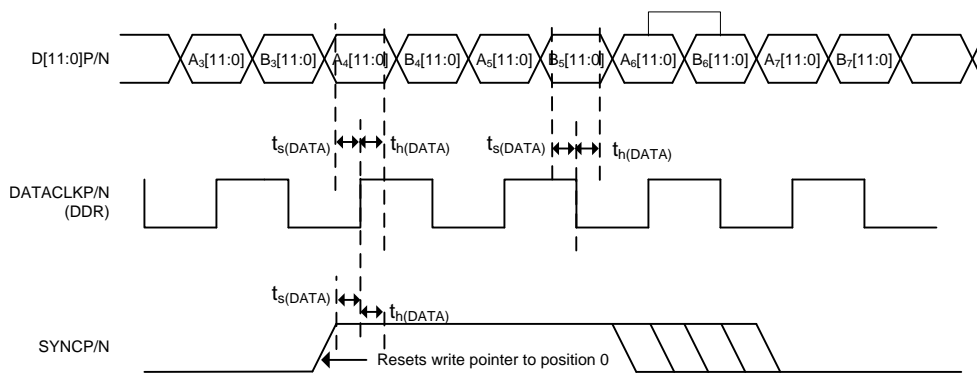

Figure 47. DAC3164 Input Timing Diagram for Dual Channel DDR Mode

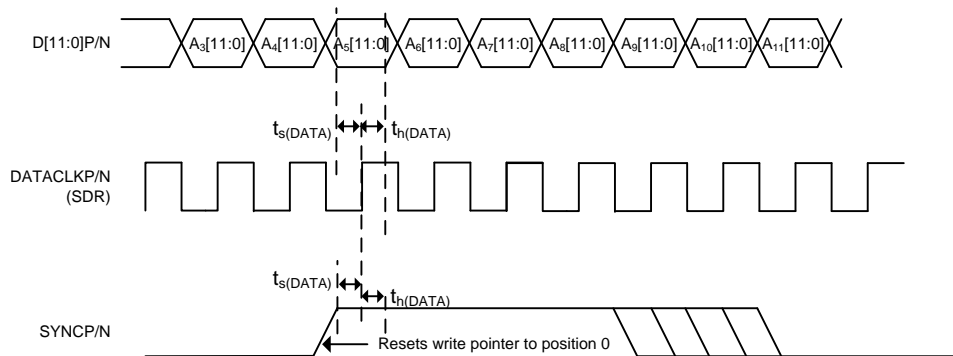

Figure 48. DAC3164 Input Timing Diagram for Single Channel SDR Mode

**DATA INPUT FORMATS**

**Table 1. DAC3154 Dual Channel DDR Mode**

DIFFERENTIAL PAIR (P/N)	BITS	
	DATACLK RISING EDGE	DATACLK FALLING EDGE
D9	A9	B9
D8	A8	B8
D7	A7	B7
D6	A6	B6
D5	A5	B5
D4	A4	B4
D3	A3	B3
D2	A2	B2
D1	A1	B1
D0	A0	B0
SYNC	FIFO Write Reset	–

**Table 2. DAC3154 Single Channel SDR Mode**

DIFFERENTIAL PAIR (P/N)	BITS	
	DATACLK RISING EDGE	DATACLK FALLING EDGE
D9	A9	
D8	A8	
D7	A7	
D6	A6	
D5	A5	
D4	A4	
D3	A3	
D2	A2	
D1	A1	
D0	A0	
SYNC	FIFO Write Reset	–

**Table 3. DAC3164 Dual Channel DDR Mode**

DIFFERENTIAL PAIR (P/N)	BITS	
	DATACLK RISING EDGE	DATACLK FALLING EDGE
D11	A11	B11
D10	A10	B10
D9	A9	B9
D8	A8	B8
D7	A7	B7
D6	A6	B6
D5	A5	B5
D4	A4	B4
D3	A3	B3
D2	A2	B2
D1	A1	B1
D0	A0	B0
SYNC	FIFO Write Reset	–



**Table 4. DAC3164 Single Channel DDR Mode**

DIFFERENTIAL PAIR (P/N)	BITS	
	DATACLK RISING EDGE	DATACLK FALLING EDGE
D11	A11	
D10	A10	
D9	A9	
D8	A8	
D7	A7	
D6	A6	
D5	A5	
D4	A4	
D3	A3	
D2	A2	
D1	A1	
D0	A0	
SYNC	FIFO Write Reset	–

## SERIAL INTERFACE DESCRIPTION

The serial port of the DAC3154/DAC3164 is a flexible serial interface which communicates with industry standard microprocessors and microcontrollers. The interface provides read/write access to all registers used to define the operating modes of DAC3154/DAC3164. It is compatible with most synchronous transfer formats and can be configured as a 3 or 4 pin interface by *sif4\_ena* in register config0, bit9. In both configurations, SCLK is the serial interface input clock and SDENB is serial interface enable. For 3 pin configuration, SDIO is a bidirectional pin for both data in and data out. For 4 pin configuration, SDIO is data in only and SDO is data out only. Data is input into the device with the rising edge of SCLK. Data is output from the device on the falling edge of SCLK.

Each read/write operation is framed by signal SDENB (Serial Data Enable Bar) asserted low. The first frame byte is the instruction cycle which identifies the following data transfer cycle as read or write as well as the 7-bit address to be accessed. [Table 5](#) indicates the function of each bit in the instruction cycle and is followed by a detailed description of each bit. The data transfer cycle consists of two bytes.

**Table 5. Instruction byte of the Serial interface**

Bit	MSB							LSB
	7	6	5	4	3	2	1	0
Description	R/W	A6	A5	A4	A3	A2	A1	A0

R/W Identifies the following data transfer cycle as a read or write operation. A high indicates a read operation from DAC3154/DAC3164 and a low indicates a write operation to DAC3154/DAC3164.

[A6 : A0] Identifies the address of the register to be accessed during the read or write operation.

[Figure 49](#) shows the serial interface timing diagram for a DAC3154/DAC3164 write operation. SCLK is the serial interface clock input to DAC3154/DAC3164. Serial data enable SDENB is an active low input to DAC3154/DAC3164. SDIO is serial data in. Input data to DAC3154/DAC3164 is clocked on the rising edges of SCLK.

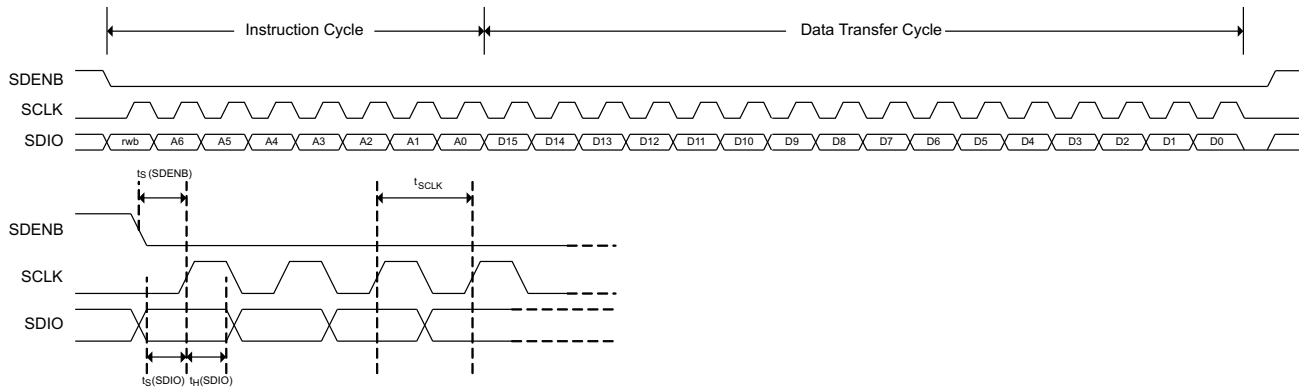

**Figure 49. Serial Interface Write Timing Diagram**

[Figure 50](#) shows the serial interface timing diagram for a DAC3154/DAC3164 read operation. SCLK is the serial interface clock input to DAC3154/DAC3164. Serial data enable SDENB is an active low input to DAC3154/DAC3164. SDIO is serial data in during the instruction cycle. In 3 pin configuration, SDIO is data out from the DAC3154/DAC3164 during the data transfer cycle, while SDO is in a high-impedance state. In 4 pin configuration, both SDIO and SDO are data out from the DAC3154/DAC3164 during the data transfer cycle. At the end of the data transfer, SDIO and SDO will output low on the final falling edge of SCLK until the rising edge of SDENB when they will 3-state.

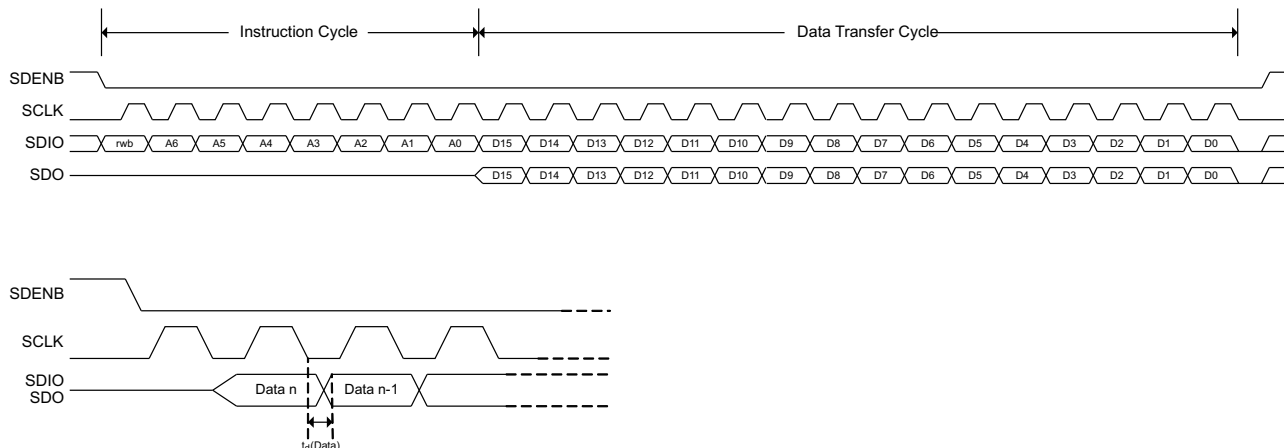

**Figure 50. Serial Interface Read Timing Diagram**

## REGISTER DESCRIPTIONS

In the SIF interface there are four types of registers:

**NORMAL:** The NORMAL register type allows data to be written and read from. All 16-bits of the data are registered at the same time. There is no synchronizing with an internal clock thus all register writes are asynchronous with respect to internal clocks. There are three subtypes of NORMAL:

**AUTOSYNC:** A NORMAL register that causes a sync to be generated after the write is finished. These are most commonly used in things like offsets and phaseadd where there is a word or block setup that extends across multiple registers and all of the registers need to be programmed before any take effect on the circuit. For example, the phaseadd is two registers long. It wouldn't serve the user to have the first write 16 of the 32 bits cause a change in the frequency, so the design allows all the registers to be written and then when that last one for this block is finished, an autosync is generated for the mixer telling it to grab all the new SIF values. This will occur on a mixer clock cycle so that no meta-stability errors occur.

**No RESET Value:** These are NORMAL registers, but for one reason or another reset value can not be guaranteed. This could be because the register has some read\_only bits or some internal logic partially controls the bit values. An example is the SIF\_CONFIG6 register. The bits come from the temperature sensor and the fuses. Depending on which fuses are blown and what the die temp is the reset value will be different.

**FUSE controlled:** While this isn't a type of register, you may see this description in the area describing the default value for the register. What it means is that fuses will change the default value and the value shown in the document is for when no fuses are blown.

**READ\_ONLY:** Registers that are internal wires ANDed with the address bus then connected to the SIF output data bus.

**WRITE\_TO\_CLEAR:** These registers are just like NORMAL registers with one exception. They can be written and read, however, when the internal logic asynchronously sets a bit high in one of these registers, that bit stays high until it is written to '0'. This way interrupts will be captured and stay constant until cleared by the user.

Table 6. Register Map

Name	Address	Default	(MSB) Bit 15	Bit 14	Bit 13	Bit 12	Bit 11	Bit 10	Bit 9	Bit 8	Bit 7	Bit 6	Bit 5	Bit 4	Bit 3	Bit 2	Bit 1	(LSB) Bit 0		
config0	0x00	0x44FC	qmc_offset_ena	dual_ena	chipwidth (1:0)		reserved	twos	sif4_ena	reserved	fifo_ena	alarm_out_ena	alarm_out_pol	alignrx_ena	syncrx_ena	lvdsdataclk_ena	reserved	synconly_ena		
config1	0x01	0x600E	iotest_ena	bsideclk_ena	fullword_interface_ena	64cnt_ena	dacclkgone_ena	dataclkgone_ena	collision_ena	reserved	daca_compliment	dacb_compliment	sif_sync	sif_sync_ena	alarm_2away_ena	alarm_1away_ena	alarm_collision_ena	reserved		
config2	0x02	0x3FFF	reserved		lvdsdata_ena (13:0)															
config3	0x03	0x0000	datadya (2:0)			clkdiya (2:0)			datadyb (2:0)			ckldyb (2:0)			extref_ena	reserved	dual_ena			
config4	0x04	0x0000	reserved		iotest_results (13:0)															
config5	0x05	0x0000	alarm_from_zerochka	alarm_from_zerochkb	alarms_from_fifoa (2:0)			alarms_from_fifob (2:0)			alarm_dacclk_gone	alarm_dataclk_gone	clock_gone	alarm_from_iotesta	alarm_from_iotestb	reserved				
config6	0x06	0x0084(DAC3164) 0x0088(DAC3154)	tempdata (7:0)							fuse_cntl (5:0)							reserved			
config7	0x07	0xFFFF	alarms_mask (15:0)																	
config8	0x08	0x4000	reserved				qmc_offseta (12:0)													
config9	0x09	0x8000	fifo_offset (2:0)				qmc_offsetb (12:0)													
config10	0x0A	0xF080	coarse_dac (3:0)				fuse_sleep	reserved	reserved	tsense_sleep	clkrecv_ena	sleepa	sleepb	reserved						
config11	0x0B	0x1111	reserved				reserved				reserved				reserved					
config12	0x0C	0x3A7A	reserved		iotest_pattern0 (13:0)															
config13	0x0D	0x36B6	reserved		iotest_pattern1 (13:0)															
config14	0x0E	0x2AEA	reserved		iotest_pattern2 (13:0)															
config15	0x0F	0x0545	reserved		iotest_pattern3 (13:0)															
config16	0x10	0x1A1A	reserved		iotest_pattern4 (13:0)															
config17	0x11	0x1616	reserved		iotest_pattern5 (13:0)															
config18	0x12	0x2AAA	reserved		iotest_pattern6 (13:0)															
config19	0x13	0x06C6	reserved		iotest_pattern7 (13:0)															
config20	0x14	0x0000	sifdac_ena	reserved	sifdac (13:0)															
config21	0x15	0xFFFF	sleepcntl (15:0)																	
config22	0x16	0x0000	fa002_data(15:0)																	
config23	0x17	0x0000	fa002_data(31:16)																	
config24	0x18	0x0000	fa002_data(47:32)																	
config25	0x19	0x0000	fa002_data(63:48)																	
config127	0x7F	0x0044	reserved	reserved	reserved	reserved	reserved	reserved	reserved	reserved	reserved	titest_voh	titest_voi	vendorid (1:0)	versionid (2:0)					

**Register name: config0 – Address: 0x00, Default: 0x44FC**

Register Name	Addr (Hex)	Bit	Name	Function	Default Value
config0	0x00	15	qmc_offset_ena	Enable the offset function when asserted.	0
		14	dual_ena	Utilizes both DACs when asserted.	1 FUSE controlled
		13:12	chipwidth	Programmable bits for setting the input interface width. 00: all 14 bits are used. <b>NOTE: not applicable to DAC3154/DAC3164.</b> 01: upper 12 bits are used 10: upper 10 bits are used 11: upper 10 bits are used	00
		11	reserved	reserved	0
		10	twos	When asserted, this bit tells the chip to presume 2's complement data is arriving at the input. Otherwise offset binary is presumed.	1
		9	sif4_ena	When asserted the SIF interface becomes a 4 pin interface. This bit has a lower priority than the <b>dieid_ena</b> bit.	0
		8	reserved	reserved	0
		7	fifo_ena	When asserted, the FIFO is absorbing the difference between INPUT clock and DAC clock. If it is not asserted then the FIFO buffering is bypassed but the reversing of bits and handling of offset binary input is still available. <b>NOTE: When the FIFO is bypassed the DACCLK and DATACLK must be aligned or there may be timing errors; and, it is not recommended for actual application use.</b>	1
		6	alarm_out_ena	When asserted the pin alarm becomes an output instead of a tri-stated pin.	1
		5	alarm_out_pol	This bit changes the polarity of the ALARM signal. (0=negative logic, 1=positive logic)	1
		4	alignrx_ena	When asserted the ALIGN pin receiver is powered up. <b>NOTE: It is recommended to clear this bit when ALIGNP/N are not used.</b>	1
		3	syncrx_ena	When asserted the SYNC pin receiver is powered up. <b>NOTE: It is recommended to clear this bit when SYNC P/N are not used.</b>	1
		2	lvdsdataclk_ena	When asserted the DATACLK pin receiver is powered up.	1
		1	reserved	reserved	0
0	synconly_ena	When asserted the chip is put into the SYNC ONLY mode where the SYNC pin is used as the sync input for both the front and back of the FIFO.	0		

**Register name: config1 – Address: 0x01, Default: 0x600E**

Register Name	Addr (Hex)	Bit	Name	Function	Default Value
config1	0x01	15	iotest_ena	Turns on the io-testing circuitry when asserted. This is the circuitry that will compare a 8 sample input pattern to SIF programmed registers to make sure the data coming into the chip meets setup/hold requirements. If this bit is a '0' then the clock to this circuitry is turned off for power savings. <b>NOTE: Sample 0 should be aligned with the rising edge of SYNC.</b>	0
		14	bsideclk_ena	When asserted the input clock for the B side datapath is enabled. Otherwise the IO TEST and the FIFO on the B side of the design will not get a clock.	1
		13	reserved	reserved.	1
		12	64cnt_ena	This enables the resetting of the alarms after 64 good samples with the goal of removing unnecessary errors. For instance on a lab board, when checking the setup/hold through IO TEST, there may initially be errors, but once the test is up and running everything works. Setting this bit removes the need for a SIF write to clear the alarm register.	0
		11	dacclkgone_ena	This allows the DACCLK gone signal from the clock monitor to be used to shut the output off.	0
		10	dataclkgone_end	This allows the DATACLK gone signal from the clock monitor to be used to shut the output off.	0
		9	collision_ena	This allows the collision alarm from the FIFO to shut the output off	0
		8	reserved	reserved.	0
		7	daca_compliment	When asserted the output to the DACA is complimented. This allows the user of the chip to effectively change the + and – designations of the DAC output pins.	0
		6	dacb_compliment	When asserted the output to the DACB is complimented. This allows the user of the chip to effectively change the + and – designations of the DAC output pins.	0
		5	sif_sync	This is the SIF_SYNC signal. Whatever is programmed into this bit will be used as the chip sync when SIF_SYNC mode is enabled. Design is sensitive to rising edges so programming from 0->1 is when the sync pulse is generated. 1->0 has no effect.	0
		4	sif_sync_ena	When asserted enable SIF_SYNC mode.	0
		3	alarm_2away_ena	When asserted alarms from the FIFO that represent the pointers being 2 away are enabled	1
		2	alarm_1away_ena	When asserted alarms from the FIFO that represent the pointers being 1 away are enabled	1
		1	alarm_collision_ena	When asserted the collision of FIFO pointers causes an alarm to be generated	1
0	reserved	reserved	0		

**Register name: config2 – Address: 0x02, Default: 0x3FFF**

Register Name	Addr (Hex)	Bit	Name	Function	Default Value
config2	0x02	15	reserved	reserved	0
		14	reserved	reserved	0
		13:0	lvdsdata_ena	These 14 bits are individual enables for the 14 input pin receivers. <b>NOTE: It is recommended to clear bit (1:0) for the 12-bit DAC3164, and clear bit (3:0) for the 10-bit DAC3154.</b>	0x3FFF

**Register name: config3 – Address: 0x03, Default: 0x0000**

Register Name	Addr (Hex)	Bit	Name	Function	Default Value
config3	0x03	15:13	datadlya	Controls the delay of the A data inputs through the LVDS receivers. 0= no additional delay and each LSB adds a nominal 80ps.	000
		12:10	clkdlya	Controls the delay of the A data clock input through the LVDS receivers. 0= no additional delay and each LSB adds a nominal 80ps.	000
		9:7	datadlyb	Controls the delay of the B data inputs through the LVDS receivers. 0= no additional delay and each LSB adds a nominal 80ps.	000
		6:4	clkdlyb	Controls the delay of the B data clock input through the LVDS receivers. 0= no additional delay and each LSB adds a nominal 80ps.	000
		3	extref_ena	Enable external reference for the DAC when set.	0
		2:1	reserved	reserved	00
		0	dual_clock_ena	When asserted it tells the LVDS input circuit that there are two individual data clocks. <b>NOTE: must be in SIF_SYNC mode, and not applicable to DAC3154/DAC3164.</b>	0

**Register name: config4 – Address: 0x04, Default: 0x0000**

Register Name	Addr (Hex)	Bit	Name	Function	Default Value
config4 WRITE TO CLEAR/ No RESET value	0x04	15:14	reserved	reserved	00
		13:0	iotest_results	The values of these bits tell which bit in the input word failed during the io-test pattern comparison. Bit 13 corresponds to the MSB input.	0x0000

**Register name: config5 – Address: 0x05, Default: 0x0000**

Register Name	Addr (Hex)	Bit	Name	Function	Default Value
config5 WRITE TO CLEAR	0x05	15	alarm_from_ zerochka	When this bit is asserted the FIFO A write pointer has an all zeros pattern in it. Since this pointer is a shift register, all zeros will cause the input point to be stuck until the next sync. The result could be a repeated 8T pattern at the output if the mixer is off and no syncs occur. Check for this error will tell the user that another sync is necessary to restart the FIFO write pointer.	0
		14	alarm_from_ zerochkb	When this bit is asserted the FIFO B write pointer has an all zeros pattern in it. Since this pointer is a shift register, all zeros will cause the input point to be stuck until the next sync. The result could be a repeated 8T pattern at the output if the mixer is off and no syncs occur. Check for this error will tell the user that another sync is necessary to restart the FIFO write pointer.	0
		13:11	alarms_from_ fifoa	These bits report the FIFO A pointer status. 000: All fine 001: Pointers are 2 away 01X: Pointers are 1 away 1XX: FIFO Pointer collision	000
		10:8	alarms_from_ fifob	These bits report the FIFO B pointer status. 000: All fine 001: Pointers are 2 away 01X: Pointers are 1 away 1XX: FIFO Pointer collision	0
		7	alarm_dacclk_ gone	Bit gets asserted when the DACCLK has been stopped long for enough cycles to be caught. The number of cycles varies with interpolation.	0
		6	alarm_dataclk_ gone	Bit gets asserted when the DATACLK has been stopped long for enough cycles to be caught. The number of cycles varies with interpolation.	0
		5	clock_gone	This bit gets set when either alarm_dacclk_gone or alarm_dataclk_gone are asserted. It controls the output of the CDRV_SER block. When high, the CDRV_SER block will output "0x8000" for each output connected to a DAC. The bit must be written to '0' for CDRV_SER outputs to resume normal operation.	0
		4	alarm_from_ iotesta	This is asserted when the input data pattern does not match the pattern in the iotest_pattern registers.	0
		3	alarm_from_ iotestb	This is asserted when the input data pattern does not match the pattern in the iotest_pattern registers.	0
		2	reserved	reserved	0
1	reserved	reserved	0		
0	reserved	reserved	0		



**Register name: config6 – Address: 0x06, Default: 0x0084 (DAC3164); 0x0088 (DAC3154)**

Register Name	Addr (Hex)	Bit	Name	Function	Default Value
config6 No RESET Value	0x06	15:8	tempdata	This the output from the chip temperature sensor. <b>NOTE: when reading these bits the SIF interface must be extremely slow, 1MHz range.</b>	0x00
		7:2	fuse_cntl	These are the values of the blown fuses and are used to determine the available functionality in the chip. <b>NOTE: These bits are READ_ONLY and allow the user to check what features have been disabled in the device.</b> bit5 = 1: Force full word interface. bit4 = 1: reserved bit3 = 1: reserved bit2 = 1: Forces Single DAC Mode. <b>Note: This does not force the channel B in sleep mode. In order to do so, user needs to program the sleepb SPI bit (config10, bit 5) to "1".</b> bit1:0 : Forces a different bits size. "00" 14bit. "01" 12bit "10" 10bit "11" 10bit	0x21 for DAC3164; 0x22 for DAC3154
		1	reserved	reserved	0
		0	reserved	reserved	0

**Register name: config7 – Address: 0x07, Default: 0xFFFF**

Register Name	Addr (Hex)	Bit	Name	Function	Default Value
config7	0x07	15:0	alarms_mask	Each bit is used to mask an alarm. Assertion masks the alarm: bit15 = alarm_mask_zerocka bit14 = alarm_mask_zerockb bit13 = alarm_mask_fifo_a_collision bit12 = alarm_mask_fifo_a_1away bit11 = alarm_mask_fifo_a_2away bit10 = alarm_mask_fifo_b_collision bit9 = alarm_mask_fifo_b_1away bit8 = alarm_mask_fifo_b_2away bit7 = alarm_mask_dacclk_gone bit6 = alarm_mask_dataclk_gone bit5 = Masks the signal which turns off the DAC output when a clock or collision occurs. This bit has no effect on the PAD_ALARM output. bit4 = alarm_mask_iotesta bit3 = alarm_mask_iotestb bit2 = bit1 = bit0 =	0xFFFF

**Register name: config8 – Address: 0x08, Default: 0x4000**

Register Name	Addr (Hex)	Bit	Name	Function	Default Value
config8	0x08	15:13	reserved	reserved	010
		12:0	qmc_offseta	The DAC A offset correction. The offset is measured in DAC LSBs.	0x0000

**Register name: config9 – Address: 0x09, Default: 0x8000**

Register Name	Addr (Hex)	Bit	Name	Function	Default Value
config9 AUTO SYNC	0x09	15:13	fifo_offset	This is the starting point for the READ_POINTER in the FIFO block. The READ_POINTER is set to this location when a sync occurs on the DACCLK side of the FIFO.	100
		12:0	qmc_offsetb	The DAC B offset correction. The offset is measured in DAC LSBs. <b>NOTE: Writing this register causes an autosync to be generated in the QMOFFSET block.</b>	0x0000

**Register name: config10 – Address: 0x0A, Default: 0xF080**

Register Name	Addr (Hex)	Bit	Name	Function	Default Value
Config10	0x0A	15:12	coarse_dac	Scales the output current is 16 equal steps. $\frac{V_{refO}}{R_{bias}} \times (\text{mem\_coarse\_daca} + 1)$	1111
		11	fuse_sleep	Put the fuses to sleep when set high.	0
		10	reserved	reserved	0
		9	reserved	reserved	0
		8	tsense_sleep	When asserted the temperature sensor is put to sleep.	0
		7	clkrecv_ena	Turn on the DAC CLOCK receiver block when asserted.	1
		6	sleepa	When asserted DACA is put to sleep.	0
		5	sleepb	When asserted DACB is put to sleep. <b>Note: This bit needs to be programmed to "1" for single DAC mode.</b>	0
		4:0	reserved	reserved	00000

**Register name: config11 – Address: 0x0B, Default: 0x1111**

Register Name	Addr (Hex)	Bit	Name	Function	Default Value
config11	0x0B	15:12	reserved	reserved	0001
		11:8	reserved	reserved	0001
		7:4	reserved	reserved	0001
		3:0	reserved	reserved	0001

**Register name: config12 – Address: 0x0C, Default: 0x3A7A**

Register Name	Addr (Hex)	Bit	Name	Function	Default Value
config12	0x0C	15:14	reserved	reserved	00
		13:0	iotest_pattern0	This is dataword0 in the IO test pattern. It is used with the seven other words to test the input data. <b>NOTE: This word should be aligned with the rising edge of SYNC when testing the IO interface.</b>	0x3A7A

**Register name: config13 – Address: 0x0D, Default: 0x36B6**

Register Name	Addr (Hex)	Bit	Name	Function	Default Value
config13	0x0D	15:14	reserved	reserved	00
		13:0	iotest_pattern1	This is dataword1 in the IO test pattern. It is used with the seven other words to test the input data.	0x36B6

**Register name: config14 – Address: 0x0E, Default: 0x2AEA**

Register Name	Addr (Hex)	Bit	Name	Function	Default Value
config14	0x0E	15:14	reserved	reserved	00
		13:0	iotest_pattern2	This is dataword2 in the IO test pattern. It is used with the seven other words to test the input data.	0x2AEA

**Register name: config15 – Address: 0x0F, Default: 0x0545**

Register Name	Addr (Hex)	Bit	Name	Function	Default Value
config15	0x0F	15:14	reserved	reserved	00
		13:0	iotest_pattern3	This is dataword3 in the IO test pattern. It is used with the seven other words to test the input data.	0x0545

**Register name: config16 – Address: 0x10, Default: 0x1A1A**

Register Name	Addr (Hex)	Bit	Name	Function	Default Value
config16	0x10	15:14	reserved	reserved	00
		13:0	iotest_pattern4	This is dataword4 in the IO test pattern. It is used with the seven other words to test the input data.	0x1A1A

**Register name: config17 – Address: 0x11, Default: 0x1616**

Register Name	Addr (Hex)	Bit	Name	Function	Default Value
config17	0x11	15:14	reserved	reserved	00
		13:0	iotest_pattern5	This is dataword5 in the IO test pattern. It is used with the seven other words to test the input data.	0x1616

**Register name: config18 – Address: 0x12, Default: 0x2AAA**

Register Name	Addr (Hex)	Bit	Name	Function	Default Value
config18	0x12	15:14	reserved	reserved	00
		13:0	iotest_pattern5	This is dataword6 in the IO test pattern. It is used with the seven other words to test the input data.	0x2AAA

**Register name: config19 – Address: 0x13, Default: 0x06C6**

Register Name	Addr (Hex)	Bit	Name	Function	Default Value
config19	0x13	15:14	reserved	reserved	00
		13:0	iotest_pattern7	This is dataword7 in the IO test pattern. It is used with the seven other words to test the input data.	0x06C6

**Register name: config20– Address: 0x14, Default: 0x0000**

Register Name	Addr (Hex)	Bit	Name	Function	Default Value
config20	0x14	15	sifdac_ena	When asserted the DAC output is set to the value in sifdac. This can be used for trim setting and other static tests.	0
		14	reserved	reserved	0
		13:0	sifdac	This is the value that is sent to the DACs when sifdac_ena is asserted.	0x0000

**Register name: config21– Address: 0x15, Default: 0xFFFF**

Register Name	Addr (Hex)	Bit	Name	Function	Default Value
config21	0x15	15:0	sleepcntl	<p>This controls what blocks get sent a SLEEP signal when the PAD_SLEEP pin is asserted. Programming a '1' in a bit will pass the SLEEP signal to the appropriate block.</p> <p>bit15 = DAC A bit14 = DAC B bit13 = FUSE Sleep bit12 = Temperature Sensor bit11 = Clock Receiver bit10 = LVDS DATA Receivers bit9 = LVDS SYNC Receiver bit8 = PECL ALIGN Receiver bit7 = LVDS DATACLK Receiver bit6 = bit5 = bit4 = bit3 = bit2 = bit1 = bit0 =</p>	0xFFFF

**Register name: config22– Address: 0x16**

Register Name	Addr (Hex)	Bit	Name	Function	Default Value
config22 READ ONLY	0x16	15:0	fa002_data(15:0)	Lower 16bits of the DIE ID word	

**Register name: config23– Address: 0x17**

Register Name	Addr (Hex)	Bit	Name	Function	Default Value
config23 READ ONLY	0x17	15:0	fa002_data(31:16)	Lower middle 16bits of the DIE ID word	

**Register name: config24– Address: 0x18, Default**

Register Name	Addr (Hex)	Bit	Name	Function	Default Value
config24 READ ONLY	0x18	15:0	fa002_data(47:32)	Upper middle 16bits of the DIE ID word	

**Register name: config25– Address: 0x19**

Register Name	Addr (Hex)	Bit	Name	Function	Default Value
config25 READ ONLY	0x19	15:0	fa002_data(63:48)	Upper 16bits of the DIE ID word	

**Register name: config127– Address: 0x7F, Default: 0x0045**

Register Name	Addr (Hex)	Bit	Name	Function	Default Value
config127 READ ONLY/No RESET Value	0x7F	15:14	reserved	reserved	00
		13:12	reserved	reserved	00
		11:10	reserved	reserved	00
		9:8	reserved	reserved	00
		7	reserved	reserved	0
		6	titest_voh	A fixed '1' that can be used to test the Voh at the SIF output.	1
		5	titest_vol	A fixed '0' that can be used to test the Vol at the SIF output.	0
		4:3	vendorid	Fixed to "01".	01
		2:0	versionid	Chip version.	001

## Synchronization Modes

There are three modes of syncing included in the DAC3154/DAC3164.

- **NORMAL Dual Sync** – The SYNC pin is used to align the input side of the FIFO (write pointers) with the A(0) sample. The ALIGN pin is used to reset the output side of the FIFO (read pointers) to the offset value. Multiple chip alignment can be accomplished with this kind of syncing.
- **SYNC ONLY** – In this mode only the SYNC pin is used to sync both the read and write pointers of the FIFO. There is an asynchronized handoff between the DATACLK and DACCLK when using this mode, therefore it is impossible to accurately align multiple chips closer than 2 or 3T.
- **SIF\_SYNC** – When neither SYNC nor ALIGN are used, a programmable SYNC pulse can be used to sync the design. However, the same issues as SYNC ONLY apply. There is an asynchronized handoff between the serial clock domain and the two sides of the FIFO. Because of the asynchronous nature of the SIF\_SYNC it is impossible to align the sync up with any sample at the input.

**Note: When ALIGNP/N are not used, it is recommended to clear the alignrx\_ena register (config1, bit 4), and tie ALIGNP to DIGVDD18 and ALIGNN to GROUND. When SYNC P/N are not used, it is recommended to clear register syncrx\_ena (config0, bit3), and the unused SYNC P/N pins can be left open or tied to GROUND.**

## Alarm Monitoring

DAC3154/DAC3164 includes flexible alarm monitoring that can be used to alert a possible malfunction scenario. All alarm events can be accessed either through the SIP registers and/or through the ALARM pin. Once an alarm is set, the corresponding alarm bit in register config5 must be reset through the serial interface to allow further testing. The set of alarms includes the following conditions:

### *Zero check alarm*

- `Alarm_from_zerochk`. Occurs when the FIFO write pointer has an all zeros pattern. Since the write pointer is a shift register, all zeros will cause the input point to be stuck until the next sync event. When this happens a sync to the FIFO block is required.

### *FIFO alarms*

- `alarm_from_fifo`. Occurs when there is a collision in the FIFO pointers or a collision event is close.
- `alarm_fifo_2away`. Pointers are within two addresses of each other.
- `alarm_fifo_1away`. Pointers are within one address of each other.
- `alarm_fifo_collision`. Pointers are equal to each other.

### *Clock alarms*

- `clock_gone`. Occurs when either the DACCLK or DATALOCK have been stopped.
- `alarm_dacclk_gone`. Occurs when the DACCLK has been stopped.
- `alarm_dataclk_gone`. Occurs when the DATACLK has been stopped.

### *Pattern checker alarm*

- `alarm_from_iotest`. Occurs when the input data pattern does not match the pattern key.

To prevent unexpected DAC outputs from propagating into the transmit channel chain, DAC3154, DAC3164 includes a feature that disables the outputs when a catastrophic alarm occurs. The catastrophic alarms include FIFO pointer collision, the loss DACCLK or the loss of DATACLK. When any of these alarms occur the internal TXenable signal is driven low, causing a zeroing of the data going to the DAC in <10T. One caveat is if both clocks stop, the circuit cannot determine clock loss so no alarms are generated; therefore, no zeroing of output data occurs.

**PACKAGING INFORMATION**

Orderable Device	Status (1)	Package Type	Package Drawing	Pins	Package Qty	Eco Plan (2)	Lead/Ball Finish (6)	MSL Peak Temp (3)	Op Temp (°C)	Device Marking (4/5)	Samples
DAC3154IRGCR	ACTIVE	VQFN	RGC	64	2000	Green (RoHS & no Sb/Br)	CU NIPDAU	Level-3-260C-168 HR	-40 to 85	DAC3154I	<a href="#">Samples</a>
DAC3154IRGCT	ACTIVE	VQFN	RGC	64	250	Green (RoHS & no Sb/Br)	CU NIPDAU	Level-3-260C-168 HR	-40 to 85	DAC3154I	<a href="#">Samples</a>
DAC3164IRGCR	ACTIVE	VQFN	RGC	64	2000	Green (RoHS & no Sb/Br)	CU NIPDAU	Level-3-260C-168 HR	-40 to 85	DAC3164I	<a href="#">Samples</a>
DAC3164IRGCT	ACTIVE	VQFN	RGC	64	250	Green (RoHS & no Sb/Br)	CU NIPDAU	Level-3-260C-168 HR	-40 to 85	DAC3164I	<a href="#">Samples</a>

(1) The marketing status values are defined as follows:

**ACTIVE:** Product device recommended for new designs.

**LIFEBUY:** TI has announced that the device will be discontinued, and a lifetime-buy period is in effect.

**NRND:** Not recommended for new designs. Device is in production to support existing customers, but TI does not recommend using this part in a new design.

**PREVIEW:** Device has been announced but is not in production. Samples may or may not be available.

**OBSOLETE:** TI has discontinued the production of the device.

(2) Eco Plan - The planned eco-friendly classification: Pb-Free (RoHS), Pb-Free (RoHS Exempt), or Green (RoHS & no Sb/Br) - please check <http://www.ti.com/productcontent> for the latest availability information and additional product content details.

**TBD:** The Pb-Free/Green conversion plan has not been defined.

**Pb-Free (RoHS):** TI's terms "Lead-Free" or "Pb-Free" mean semiconductor products that are compatible with the current RoHS requirements for all 6 substances, including the requirement that lead not exceed 0.1% by weight in homogeneous materials. Where designed to be soldered at high temperatures, TI Pb-Free products are suitable for use in specified lead-free processes.

**Pb-Free (RoHS Exempt):** This component has a RoHS exemption for either 1) lead-based flip-chip solder bumps used between the die and package, or 2) lead-based die adhesive used between the die and leadframe. The component is otherwise considered Pb-Free (RoHS compatible) as defined above.

**Green (RoHS & no Sb/Br):** TI defines "Green" to mean Pb-Free (RoHS compatible), and free of Bromine (Br) and Antimony (Sb) based flame retardants (Br or Sb do not exceed 0.1% by weight in homogeneous material)

(3) MSL, Peak Temp. - The Moisture Sensitivity Level rating according to the JEDEC industry standard classifications, and peak solder temperature.

(4) There may be additional marking, which relates to the logo, the lot trace code information, or the environmental category on the device.

(5) Multiple Device Markings will be inside parentheses. Only one Device Marking contained in parentheses and separated by a "~" will appear on a device. If a line is indented then it is a continuation of the previous line and the two combined represent the entire Device Marking for that device.

(6) Lead/Ball Finish - Orderable Devices may have multiple material finish options. Finish options are separated by a vertical ruled line. Lead/Ball Finish values may wrap to two lines if the finish value exceeds the maximum column width.

**Important Information and Disclaimer:** The information provided on this page represents TI's knowledge and belief as of the date that it is provided. TI bases its knowledge and belief on information provided by third parties, and makes no representation or warranty as to the accuracy of such information. Efforts are underway to better integrate information from third parties. TI has taken and continues to take reasonable steps to provide representative and accurate information but may not have conducted destructive testing or chemical analysis on incoming materials and chemicals. TI and TI suppliers consider certain information to be proprietary, and thus CAS numbers and other limited information may not be available for release.

In no event shall TI's liability arising out of such information exceed the total purchase price of the TI part(s) at issue in this document sold by TI to Customer on an annual basis.



## TAPE AND REEL INFORMATION



### QUADRANT ASSIGNMENTS FOR PIN 1 ORIENTATION IN TAPE



\*All dimensions are nominal

Device	Package Type	Package Drawing	Pins	SPQ	Reel Diameter (mm)	Reel Width W1 (mm)	A0 (mm)	B0 (mm)	K0 (mm)	P1 (mm)	W (mm)	Pin1 Quadrant
DAC3154IRGCR	VQFN	RGC	64	2000	330.0	16.4	9.3	9.3	1.5	12.0	16.0	Q2
DAC3154IRGCT	VQFN	RGC	64	250	330.0	16.4	9.3	9.3	1.5	12.0	16.0	Q2
DAC3164IRGCR	VQFN	RGC	64	2000	330.0	16.4	9.3	9.3	1.5	12.0	16.0	Q2
DAC3164IRGCT	VQFN	RGC	64	250	330.0	16.4	9.3	9.3	1.5	12.0	16.0	Q2

## TAPE AND REEL BOX DIMENSIONS



\*All dimensions are nominal

Device	Package Type	Package Drawing	Pins	SPQ	Length (mm)	Width (mm)	Height (mm)
DAC3154IRGCR	VQFN	RGC	64	2000	336.6	336.6	28.6
DAC3154IRGCT	VQFN	RGC	64	250	336.6	336.6	28.6
DAC3164IRGCR	VQFN	RGC	64	2000	336.6	336.6	28.6
DAC3164IRGCT	VQFN	RGC	64	250	367.0	367.0	38.0



# THERMAL PAD MECHANICAL DATA

RGC (S-PVQFN-N64)

PLASTIC QUAD FLATPACK NO-LEAD

## THERMAL INFORMATION

This package incorporates an exposed thermal pad that is designed to be attached directly to an external heatsink. The thermal pad must be soldered directly to the printed circuit board (PCB). After soldering, the PCB can be used as a heatsink. In addition, through the use of thermal vias, the thermal pad can be attached directly to the appropriate copper plane shown in the electrical schematic for the device, or alternatively, can be attached to a special heatsink structure designed into the PCB. This design optimizes the heat transfer from the integrated circuit (IC).

For information on the Quad Flatpack No-Lead (QFN) package and its advantages, refer to Application Report, QFN/SON PCB Attachment, Texas Instruments Literature No. SLUA271. This document is available at [www.ti.com](http://www.ti.com).

The exposed thermal pad dimensions for this package are shown in the following illustration.

PIN 1 INDICATOR  
CO,35

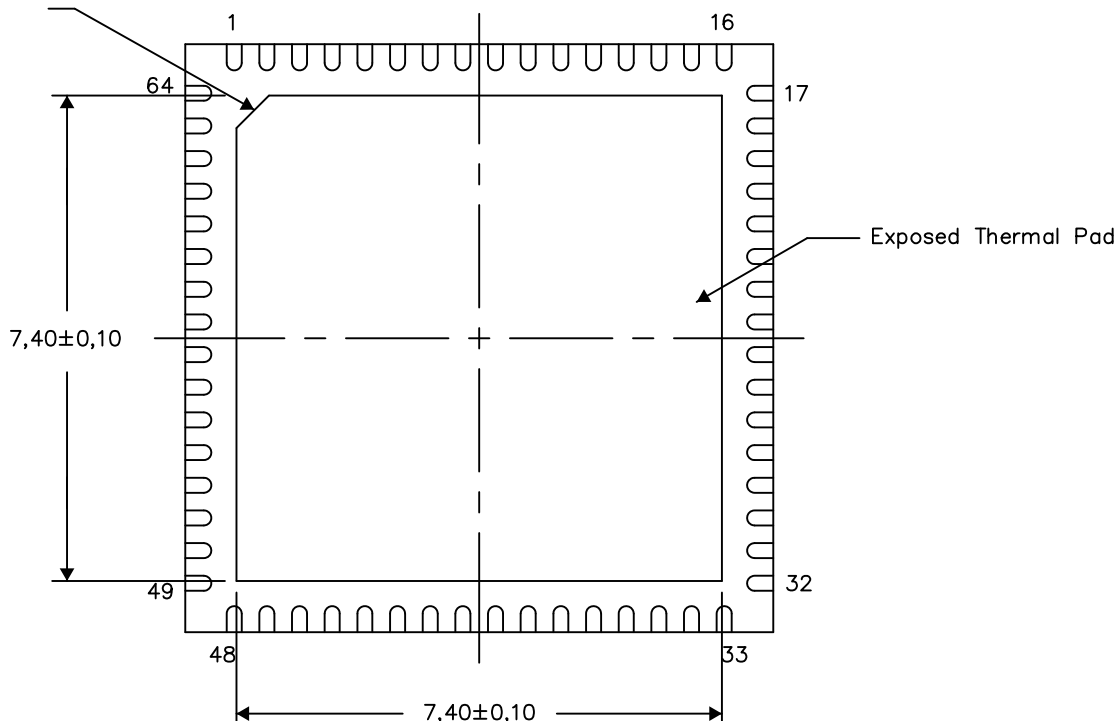

Bottom View

Exposed Thermal Pad Dimensions

4206192-4/AE 03/15

NOTE: A. All linear dimensions are in millimeters

RGC (S-PVQFN-N64)

PLASTIC QUAD FLATPACK NO-LEAD

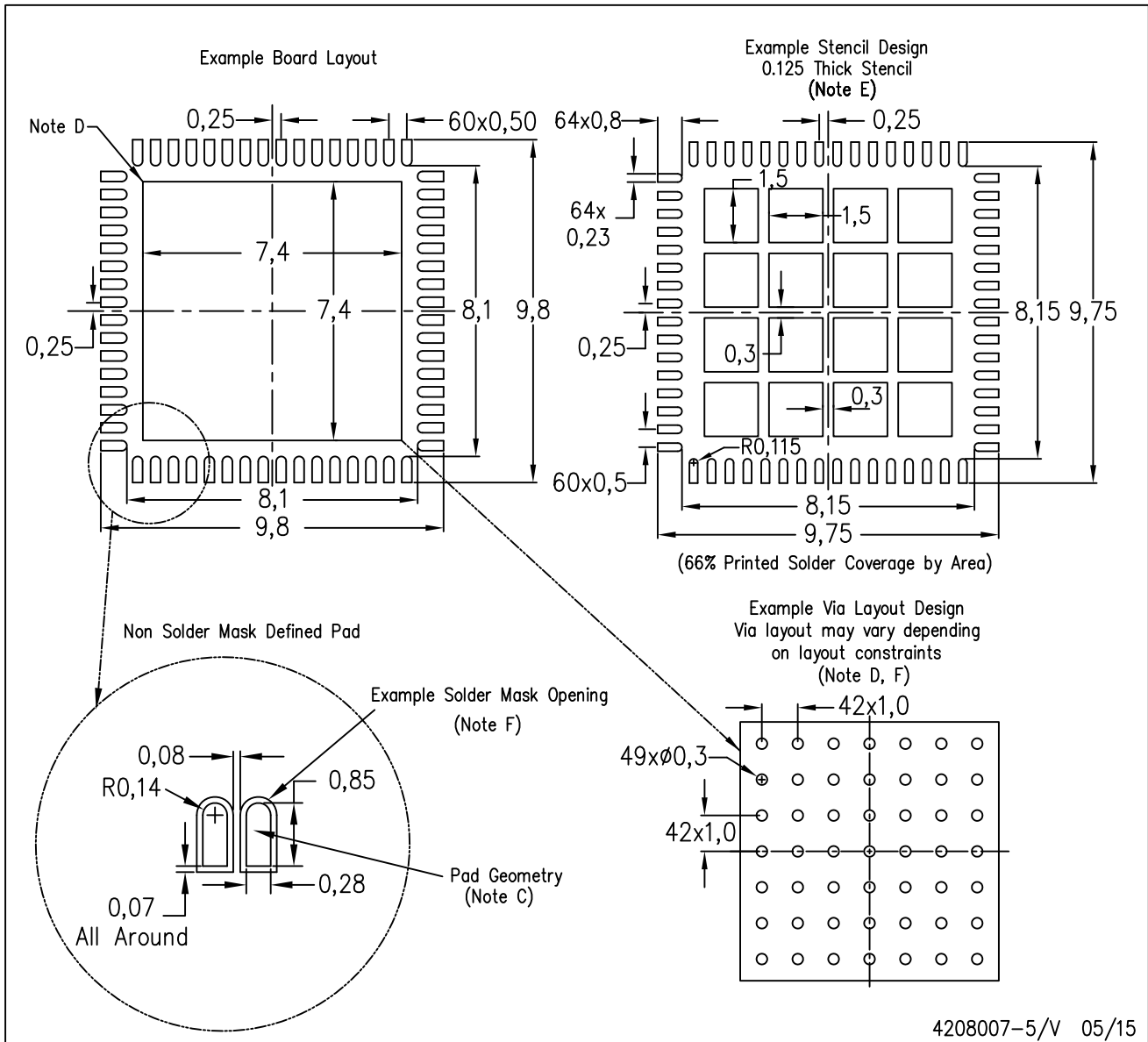

- NOTES:
- All linear dimensions are in millimeters.
  - This drawing is subject to change without notice.
  - Publication IPC-7351 is recommended for alternate designs.
  - This package is designed to be soldered to a thermal pad on the board. Refer to Application Note, Quad Flat-Pack Packages, Texas Instruments Literature No. SLUA271, and also the Product Data Sheets for specific thermal information, via requirements, and recommended board layout. These documents are available at [www.ti.com](http://www.ti.com) <<http://www.ti.com>>.
  - Laser cutting apertures with trapezoidal walls and also rounding corners will offer better paste release. Customers should contact their board assembly site for stencil design recommendations. Refer to IPC 7525 for stencil design considerations.
  - Customers should contact their board fabrication site for recommended solder mask tolerances and via tenting recommendations for vias placed in thermal pad.

## IMPORTANT NOTICE

Texas Instruments Incorporated (TI) reserves the right to make corrections, enhancements, improvements and other changes to its semiconductor products and services per JESD46, latest issue, and to discontinue any product or service per JESD48, latest issue. Buyers should obtain the latest relevant information before placing orders and should verify that such information is current and complete.

TI's published terms of sale for semiconductor products (<http://www.ti.com/sc/docs/stdterms.htm>) apply to the sale of packaged integrated circuit products that TI has qualified and released to market. Additional terms may apply to the use or sale of other types of TI products and services.

Reproduction of significant portions of TI information in TI data sheets is permissible only if reproduction is without alteration and is accompanied by all associated warranties, conditions, limitations, and notices. TI is not responsible or liable for such reproduced documentation. Information of third parties may be subject to additional restrictions. Resale of TI products or services with statements different from or beyond the parameters stated by TI for that product or service voids all express and any implied warranties for the associated TI product or service and is an unfair and deceptive business practice. TI is not responsible or liable for any such statements.

Buyers and others who are developing systems that incorporate TI products (collectively, "Designers") understand and agree that Designers remain responsible for using their independent analysis, evaluation and judgment in designing their applications and that Designers have full and exclusive responsibility to assure the safety of Designers' applications and compliance of their applications (and of all TI products used in or for Designers' applications) with all applicable regulations, laws and other applicable requirements. Designer represents that, with respect to their applications, Designer has all the necessary expertise to create and implement safeguards that (1) anticipate dangerous consequences of failures, (2) monitor failures and their consequences, and (3) lessen the likelihood of failures that might cause harm and take appropriate actions. Designer agrees that prior to using or distributing any applications that include TI products, Designer will thoroughly test such applications and the functionality of such TI products as used in such applications.

TI's provision of technical, application or other design advice, quality characterization, reliability data or other services or information, including, but not limited to, reference designs and materials relating to evaluation modules, (collectively, "TI Resources") are intended to assist designers who are developing applications that incorporate TI products; by downloading, accessing or using TI Resources in any way, Designer (individually or, if Designer is acting on behalf of a company, Designer's company) agrees to use any particular TI Resource solely for this purpose and subject to the terms of this Notice.

TI's provision of TI Resources does not expand or otherwise alter TI's applicable published warranties or warranty disclaimers for TI products, and no additional obligations or liabilities arise from TI providing such TI Resources. TI reserves the right to make corrections, enhancements, improvements and other changes to its TI Resources. TI has not conducted any testing other than that specifically described in the published documentation for a particular TI Resource.

Designer is authorized to use, copy and modify any individual TI Resource only in connection with the development of applications that include the TI product(s) identified in such TI Resource. NO OTHER LICENSE, EXPRESS OR IMPLIED, BY ESTOPPEL OR OTHERWISE TO ANY OTHER TI INTELLECTUAL PROPERTY RIGHT, AND NO LICENSE TO ANY TECHNOLOGY OR INTELLECTUAL PROPERTY RIGHT OF TI OR ANY THIRD PARTY IS GRANTED HEREIN, including but not limited to any patent right, copyright, mask work right, or other intellectual property right relating to any combination, machine, or process in which TI products or services are used. Information regarding or referencing third-party products or services does not constitute a license to use such products or services, or a warranty or endorsement thereof. Use of TI Resources may require a license from a third party under the patents or other intellectual property of the third party, or a license from TI under the patents or other intellectual property of TI.

TI RESOURCES ARE PROVIDED "AS IS" AND WITH ALL FAULTS. TI DISCLAIMS ALL OTHER WARRANTIES OR REPRESENTATIONS, EXPRESS OR IMPLIED, REGARDING RESOURCES OR USE THEREOF, INCLUDING BUT NOT LIMITED TO ACCURACY OR COMPLETENESS, TITLE, ANY EPIDEMIC FAILURE WARRANTY AND ANY IMPLIED WARRANTIES OF MERCHANTABILITY, FITNESS FOR A PARTICULAR PURPOSE, AND NON-INFRINGEMENT OF ANY THIRD PARTY INTELLECTUAL PROPERTY RIGHTS. TI SHALL NOT BE LIABLE FOR AND SHALL NOT DEFEND OR INDEMNIFY DESIGNER AGAINST ANY CLAIM, INCLUDING BUT NOT LIMITED TO ANY INFRINGEMENT CLAIM THAT RELATES TO OR IS BASED ON ANY COMBINATION OF PRODUCTS EVEN IF DESCRIBED IN TI RESOURCES OR OTHERWISE. IN NO EVENT SHALL TI BE LIABLE FOR ANY ACTUAL, DIRECT, SPECIAL, COLLATERAL, INDIRECT, PUNITIVE, INCIDENTAL, CONSEQUENTIAL OR EXEMPLARY DAMAGES IN CONNECTION WITH OR ARISING OUT OF TI RESOURCES OR USE THEREOF, AND REGARDLESS OF WHETHER TI HAS BEEN ADVISED OF THE POSSIBILITY OF SUCH DAMAGES.

Unless TI has explicitly designated an individual product as meeting the requirements of a particular industry standard (e.g., ISO/TS 16949 and ISO 26262), TI is not responsible for any failure to meet such industry standard requirements.

Where TI specifically promotes products as facilitating functional safety or as compliant with industry functional safety standards, such products are intended to help enable customers to design and create their own applications that meet applicable functional safety standards and requirements. Using products in an application does not by itself establish any safety features in the application. Designers must ensure compliance with safety-related requirements and standards applicable to their applications. Designer may not use any TI products in life-critical medical equipment unless authorized officers of the parties have executed a special contract specifically governing such use. Life-critical medical equipment is medical equipment where failure of such equipment would cause serious bodily injury or death (e.g., life support, pacemakers, defibrillators, heart pumps, neurostimulators, and implantables). Such equipment includes, without limitation, all medical devices identified by the U.S. Food and Drug Administration as Class III devices and equivalent classifications outside the U.S.

TI may expressly designate certain products as completing a particular qualification (e.g., Q100, Military Grade, or Enhanced Product). Designers agree that it has the necessary expertise to select the product with the appropriate qualification designation for their applications and that proper product selection is at Designers' own risk. Designers are solely responsible for compliance with all legal and regulatory requirements in connection with such selection.

Designer will fully indemnify TI and its representatives against any damages, costs, losses, and/or liabilities arising out of Designer's non-compliance with the terms and provisions of this Notice.