

ADC78H89 7-Channel, 500 KSPS, 12-Bit A/D Converter

Check for Samples: [ADC78H89](#)

FEATURES

- Seven Input Channels
- Variable Power Management
- Independent Analog and Digital Supplies
- SPI™/QSPI™/MICROWIRE™/DSP Compatible
- Packaged in 16-Lead TSSOP

APPLICATIONS

- Automotive Navigation
- Portable Systems
- Medical Instruments
- Mobile Communications
- Instrumentation and Control Systems

KEY SPECIFICATIONS

- Conversion Rate: 500 KSPS
- DNL: ± 1 LSB (max)
- INL: ± 1 LSB (max)
- Power Consumption
 - 3V Supply: 1.5 mW (typ)
 - 5V Supply: 8.3 mW (typ)

Connection Diagram

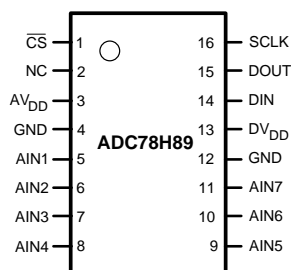

Figure 1. 16-Lead TSSOP
See PW Package

DESCRIPTION

The ADC78H89 is a low-power, seven-channel CMOS 12-bit analog-to-digital converter with a conversion throughput of 500 KSPS. The converter is based on a successive-approximation register architecture with an internal track-and-hold circuit. It can be configured to accept up to seven input signals on pins AIN1 through AIN7.

The output serial data is straight binary, and is compatible with several standards, such as SPI™, QSPI™, MICROWIRE™, and many common DSP serial interfaces.

The ADC78H89 may be operated with independent analog and digital supplies. The analog supply (AV_{DD}) can range from +2.7V to +5.25V, and the digital supply (DV_{DD}) can range from +2.7V to AV_{DD} . Normal power consumption using a +3V or +5V supply is 1.5 mW and 8.3 mW, respectively. The power-down feature reduces the power consumption to just 0.3 μ W using a +3V supply, or 0.5 μ W using a +5V supply. The ADC78H89 is packaged in a 16-lead TSSOP package. Operation over the industrial temperature range of -40°C to $+85^{\circ}\text{C}$ is ensured.



Please be aware that an important notice concerning availability, standard warranty, and use in critical applications of Texas Instruments semiconductor products and disclaimers thereto appears at the end of this data sheet.

TRI-STATE is a trademark of Texas Instruments.

All other trademarks are the property of their respective owners.



These devices have limited built-in ESD protection. The leads should be shorted together or the device placed in conductive foam during storage or handling to prevent electrostatic damage to the MOS gates.

Block Diagram

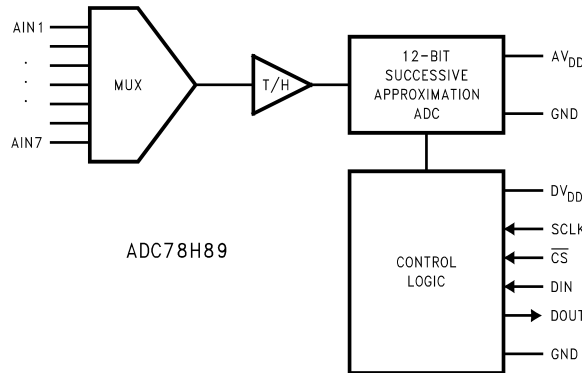

Pin Descriptions and Equivalent Circuits

Pin No.	Symbol	Equivalent Circuit	Description
ANALOG I/O			
5 - 11	AIN1 to AIN7		Analog inputs. These signals can range from 0V to AV _{DD} .
2	NC		This pin is not connected internally, and can be left floating, or tied to ground.
DIGITAL I/O			
16	SCLK		Digital clock input. The range of frequencies for this input is 50 kHz to 8 MHz, with ensured performance at 8 MHz. This clock directly controls the conversion and readout processes.
15	DOUT		Digital data output. The output samples are clocked out of this pin on falling edges of the SCLK pin.
14	DIN		Digital data input. The ADC78H89's Control Register is loaded through this pin on rising edges of the SCLK pin.
1	\overline{CS}		Chip select. On the falling edge of \overline{CS} , a conversion process begins. Conversions continue as long as \overline{CS} is held low.
POWER SUPPLY			
3	AV _{DD}		Positive analog supply pin. This pin should be connected to a quiet +2.7V to +5.25V source and bypassed to GND with 0.1 μ F ceramic monolithic and 1 μ F tantalum capacitors located within 1 cm of the power pin.
13	DV _{DD}		Positive digital supply pin. This pin should be connected to a +2.7V to AV _{DD} supply, and bypassed to GND with a 0.1 μ F ceramic monolithic capacitor located within 1 cm of the power pin.
4, 12	GND		The ground return for both analog and digital supplies. These pins are tied directly together internally, so must be connected to the same potential. If any potential exists across these pins, large currents will flow through the device.

ABSOLUTE MAXIMUM RATINGS (1) (2)

Analog Supply Voltage AV_{DD}	-0.3V to 6.5V
Digital Supply Voltage DV_{DD}	-0.3V to $AV_{DD} + 0.3V$, max 6.5V
Voltage on Any Pin to GND	-0.3V to $AV_{DD} + 0.3V$
Input Current at Any Pin (3)	±10 mA
Package Input Current (3)	±20 mA
Power Dissipation at $T_A = 25^\circ\text{C}$	See (4)
ESD Susceptibility (5)	
Human Body Model	2500V
Machine Model	250V
Soldering Temperature, Infrared, 10 seconds (6)	260°C
Junction Temperature	+150°C
Storage Temperature	-65°C to +150°C

- (1) Absolute maximum ratings are limiting values which indicate limits beyond which damage to the device may occur. Operating Ratings indicate conditions for which the device is functional, but do not ensure specific performance limits. For specifications and test conditions, see the Electrical Characteristics. The specifications apply only for the test conditions listed. Some performance characteristics may degrade when the device is not operated under the listed test conditions.
- (2) All voltages are measured with respect to GND = 0V, unless otherwise specified.
- (3) When the input voltage at any pin exceeds the power supplies (that is, $V_{IN} < AGND$ or $V_{IN} > V_A$ or V_D), the current at that pin should be limited to 10 mA. The 50 mA maximum package input current rating limits the number of pins that can safely exceed the power supplies with an input current of 10 mA to five.
- (4) The absolute maximum junction temperature (T_{Jmax}) for this device is 150°C. The maximum allowable power dissipation is dictated by T_{Jmax} , the junction-to-ambient thermal resistance (θ_{JA}), and the ambient temperature (T_A), and can be calculated using the formula $P_{DMAX} = (T_{Jmax} - T_A)/\theta_{JA}$. The values for maximum power dissipation listed above will be reached only when the ADC78H89 is operated in a severe fault condition (e.g. when input or output pins are driven beyond the power supply voltages, or the power supply polarity is reversed). Obviously, such conditions should always be avoided.
- (5) Human body model is 100 pF capacitor discharged through a 1.5 kΩ resistor. Machine model is 220 pF discharged through ZERO ohms.
- (6) See <http://www.ti.com> for other methods of soldering surface mount devices.

OPERATING RATINGS (1) (2)

Operating Temperature Range	$-40^\circ\text{C} \leq T_A \leq +85^\circ\text{C}$
AV_{DD} Supply Voltage	+2.7V to +5.25V
DV_{DD} Supply Voltage	+2.7V to AV_{DD}
Digital Input Pins Voltage Range	-0.3V to AV_{DD}
Clock Frequency	50 kHz to 8 MHz
Analog Input Voltage	0V to AV_{DD}

- (1) Absolute maximum ratings are limiting values which indicate limits beyond which damage to the device may occur. Operating Ratings indicate conditions for which the device is functional, but do not ensure specific performance limits. For specifications and test conditions, see the Electrical Characteristics. The specifications apply only for the test conditions listed. Some performance characteristics may degrade when the device is not operated under the listed test conditions.
- (2) All voltages are measured with respect to GND = 0V, unless otherwise specified.

PACKAGE THERMAL RESISTANCE

Package	θ_{JA}
16-lead TSSOP on 4-layer, 2 oz. PCB	96°C / W

ADC78H89 CONVERTER ELECTRICAL CHARACTERISTICS ⁽¹⁾

The following specifications apply for $AV_{DD} = DV_{DD} = +2.7V$ to $5.25V$, $f_{SCLK} = 8$ MHz, $f_{SAMPLE} = 500$ KSPS unless otherwise noted. **Boldface limits apply for $T_A = T_{MIN}$ to T_{MAX} :** all other limits $T_A = 25^\circ C$.

Symbol	Parameter	Conditions	Typical	Limits	Units ⁽²⁾
STATIC CONVERTER CHARACTERISTICS					
	Resolution with No Missing Codes	$AV_{DD} = +5.0V$, $DV_{DD} = +3.3V$		12	Bits
INL	Integral Non-Linearity	$AV_{DD} = +5.0V$, $DV_{DD} = +3.3V$		± 1	LSB (max)
DNL	Differential Non-Linearity	$AV_{DD} = +5.0V$, $DV_{DD} = +3.3V$		± 1	LSB (max)
OE	Offset Error	$AV_{DD} = +5.0V$, $DV_{DD} = +3.3V$		± 2	LSB (max)
OEM	Offset Error Match	$AV_{DD} = +5.0V$, $DV_{DD} = +3.3V$		± 2	LSB (max)
GE	Gain Error	$AV_{DD} = +5.0V$, $DV_{DD} = +3.3V$		± 3	LSB (max)
GEM	Gain Error Match	$AV_{DD} = +5.0V$, $DV_{DD} = +3.3V$		± 3	LSB (max)
DYNAMIC CONVERTER CHARACTERISTICS					
SINAD	Signal-to-Noise Plus Distortion Ratio	$AV_{DD} = +5.0V$, $DV_{DD} = +3.0V$, $f_{IN} = 40.2$ kHz, -0.02 dBFS	72.6		dB
SNR	Signal-to-Noise Ratio	$AV_{DD} = +5.0V$, $DV_{DD} = +3.0V$, $f_{IN} = 40.2$ kHz, -0.02 dBFS	72.8		dB
THD	Total Harmonic Distortion	$AV_{DD} = +5.0V$, $DV_{DD} = +3.0V$, $f_{IN} = 40.2$ kHz, -0.02 dBFS	-86		dB
SFDR	Spurious-Free Dynamic Range	$AV_{DD} = +5.0V$, $DV_{DD} = +3.0V$, $f_{IN} = 40.2$ kHz, -0.02 dBFS	88		dB
ENOB	Effective Number of Bits	$AV_{DD} = +5.0V$, $DV_{DD} = +3.0V$, $f_{IN} = 40.2$ kHz, -0.02 dBFS	11.8		bits
	Channel-to-Channel Crosstalk	$AV_{DD} = +5.0V$, $DV_{DD} = +3.0V$, $f_{IN} = 40.2$ kHz	-82		dB
IMD	Intermodulation Distortion, Second Order Terms	$AV_{DD} = +5.0V$, $DV_{DD} = +3.0V$, $f_a = 40.161$ kHz, $f_b = 41.015$ kHz	-93		dB
	Intermodulation Distortion, Third Order Terms	$AV_{DD} = +5.0V$, $DV_{DD} = +3.0V$, $f_a = 40.161$ kHz, $f_b = 41.015$ kHz	-90		dB
FPBW	-3 dB Full Power Bandwidth	$AV_{DD} = +5V$	11		MHz
		$AV_{DD} = +3V$	8		MHz
ANALOG INPUT CHARACTERISTICS					
V_{IN}	Input Range		0 to AV_{DD}		V
I_{DCL}	DC Leakage Current			± 1	μA (max)
C_{INA}	Input Capacitance	In Track Mode	33		pF
		In Hold Mode	3		pF
DIGITAL INPUT CHARACTERISTICS					
V_{IH}	Input High Voltage	$DV_{DD} = +4.75V$ to $+5.25V$		2.4	V (min)
		$DV_{DD} = +2.7V$ to $+3.6V$		2.1	V (min)
V_{IL}	Input Low Voltage	$DV_{DD} = +2.7V$ to $+5.25V$		0.8	V (max)
I_{IN}	Input Current	$V_{IN} = 0V$ or DV_{DD}	± 0.01	1	μA (max)
C_{IND}	Input Capacitance		2	4	pF (max)
DIGITAL OUTPUT CHARACTERISTICS					
V_{OH}	Output High Voltage	$I_{SOURCE} = 200 \mu A$, $DV_{DD} = +2.7V$ to $+5.25V$		$DV_{DD} - 0.5$	V (min)
V_{OL}	Output Low Voltage	$I_{SINK} = 200 \mu A$		0.4	V (max)
I_{OZH} , I_{OZL}	TRI-STATE Leakage Current			± 1	μA (max)
C_{OUT}	TRI-STATE Output Capacitance		2	4	pF (max)
	Output Coding		Straight (Natural) Binary		

(1) Data sheet min/max specification limits are specified by design, test, or statistical analysis.

(2) Tested limits are specified to AOQL (Average Outgoing Quality Level).

ADC78H89 CONVERTER ELECTRICAL CHARACTERISTICS ⁽¹⁾ (continued)

The following specifications apply for $AV_{DD} = DV_{DD} = +2.7V$ to $5.25V$, $f_{SCLK} = 8$ MHz, $f_{SAMPLE} = 500$ KSPS unless otherwise noted. **Boldface limits apply for $T_A = T_{MIN}$ to T_{MAX}** : all other limits $T_A = 25^\circ C$.

Symbol	Parameter	Conditions	Typical	Limits	Units ⁽²⁾
POWER SUPPLY CHARACTERISTICS ($C_L = 10$ pF) ⁽³⁾					
AV_{DD}, DV_{DD}	Analog and Digital Supply Voltages	$AV_{DD} \geq DV_{DD}$		2.7	V (min)
				5.25	V (max)
I_{DD}	Total Supply Current, Normal Mode (Operational, \overline{CS} low)	$AV_{DD} = DV_{DD} = +4.75V$ to $+5.25V$, $f_{SAMPLE} = 500$ KSPS, $f_{IN} = 40$ kHz	1.65	2.3	mA (max)
		$AV_{DD} = DV_{DD} = +2.7V$ to $+3.6V$, $f_{SAMPLE} = 500$ KSPS, $f_{IN} = 40$ kHz	0.5	2.3	mA (max)
	Total Supply Current, Shutdown (\overline{CS} high)	$AV_{DD} = DV_{DD} = +4.75V$ to $+5.25V$, $f_{SAMPLE} = 0$ KSPS	0.1		μA
		$AV_{DD} = DV_{DD} = +2.7V$ to $+3.6V$, $f_{SAMPLE} = 0$ KSPS	0.1		μA
P_D	Power Consumption, Normal Mode (Operational, \overline{CS} low)	$AV_{DD} = DV_{DD} = +4.75V$ to $+5.25V$	8.3	12	mW (max)
		$AV_{DD} = DV_{DD} = +2.7V$ to $+3.6V$	1.5	8.3	mW (max)
	Power Consumption, Shutdown (\overline{CS} high)	$AV_{DD} = DV_{DD} = +4.75V$ to $+5.25V$	0.5		μW
		$AV_{DD} = DV_{DD} = +2.7V$ to $+3.6V$	0.3		μW
AC ELECTRICAL CHARACTERISTICS					
f_{SCLK}	Maximum Clock Frequency			8	MHz (max)
	Minimum Clock Frequency		50		kHz
f_S	Maximum Sample Rate			500	KSPS (min)
t_{CONV}	Conversion Time		13	13	SCLK cycles
DC	Duty Cycle		50	40	% (min)
				60	% (max)
t_{ACQ}	Track/Hold Acquisition Time	Full-Scale Step Input		3	SCLK cycles
	Throughput Time	Conversion Time + Acquisition Time		16	SCLK cycles
f_{RATE}	Throughput Rate			500	KSPS (min)
t_{AD}	Aperture Delay		4		ns

(3) Except power supply pins.

ADC78H89 TIMING SPECIFICATIONS

The following specifications apply for $AV_{DD} = DV_{DD} = +2.7V$ to $5.25V$, $f_{SCLK} = 8$ MHz, $C_L = 50$ pF, **Boldface limits apply for $T_A = T_{MIN}$ to T_{MAX}** : all other limits $T_A = 25^\circ C$.

Symbol	Parameter	Conditions	Typical	Limits	Units
t_{1a}	SCLK High to \overline{CS} Fall Setup Time	See ⁽¹⁾		10	ns (min)
t_{1b}	SCLK Low to \overline{CS} Fall Hold Time	See ⁽¹⁾		10	ns (min)
t_2	Delay from \overline{CS} Until DOUT TRI-STATE™ Disabled			30	ns (max)
t_3	Data Access Time after SCLK Falling Edge			30	ns (max)
t_4	Data Setup Time Prior to SCLK Rising Edge			10	ns (max)
t_5	Data Valid SCLK Hold Time			10	ns (max)
t_6	SCLK High Pulse Width			0.4 x t_{SCLK}	ns (min)
t_7	SCLK Low Pulse Width			0.4 x t_{SCLK}	ns (min)
t_8	\overline{CS} Rising Edge to DOUT High-Impedance			20	ns (max)

(1) Clock may be in any state (high or low) when \overline{CS} is asserted, with the restrictions on setup and hold time given by t_{1a} and t_{1b} .

Timing Diagrams

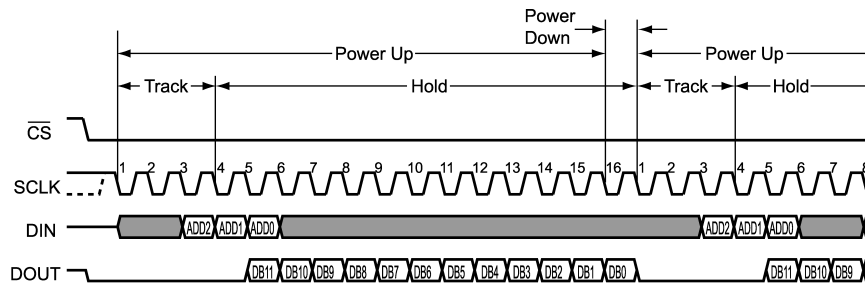

Figure 2. ADC78H89 Operational Timing Diagram

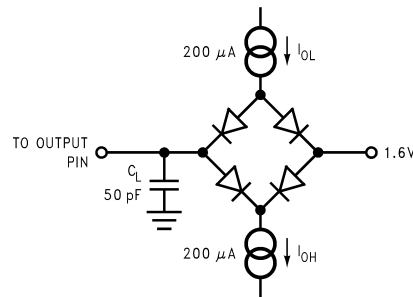

Figure 3. Timing Test Circuit

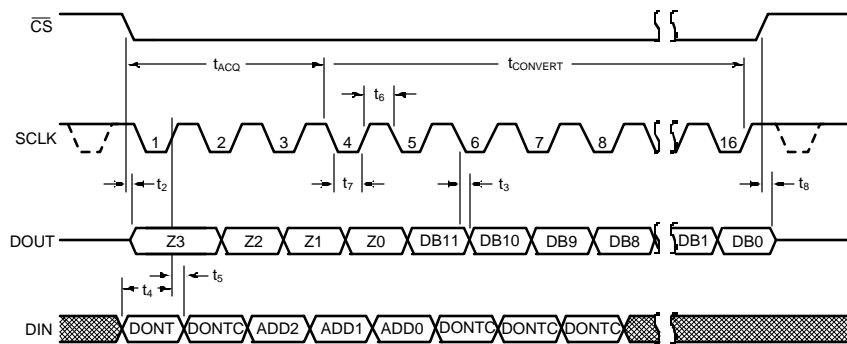

Figure 4. ADC78H89 Serial Timing Diagram

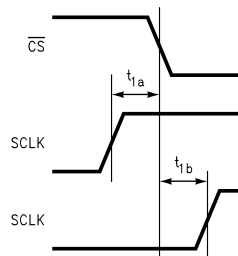

Figure 5. SCLK and CS Timing Parameters

Specification Definitions

ACQUISITION TIME is the time required to acquire the input voltage. That is, it is time required for the hold capacitor to charge up to the input voltage.

APERTURE DELAY is the time between the fourth falling SCLK edge of a conversion and the time when the input signal is acquired or held for conversion.

CONVERSION TIME is the time required, after the input voltage is acquired, for the ADC to convert the input voltage to a digital word.

CROSSTALK is the coupling of energy from one channel into the other channel, or the amount of signal energy from one analog input that appears at the measured analog input.

DIFFERENTIAL NON-LINEARITY (DNL) is the measure of the maximum deviation from the ideal step size of 1 LSB.

DUTY CYCLE is the ratio of the time that a repetitive digital waveform is high to the total time of one period. The specification here refers to the SCLK.

EFFECTIVE NUMBER OF BITS (ENOB, or EFFECTIVE BITS) is another method of specifying Signal-to-Noise and Distortion or SINAD. ENOB is defined as $(\text{SINAD} - 1.76) / 6.02$ and says that the converter is equivalent to a perfect ADC of this (ENOB) number of bits.

FULL POWER BANDWIDTH is a measure of the frequency at which the reconstructed output fundamental drops 3 dB below its low frequency value for a full scale input.

GAIN ERROR is the deviation of the last code transition (111...110) to (111...111) from the ideal ($V_{\text{REF}} - 1.5$ LSB), after adjusting for offset error.

INTEGRAL NON-LINEARITY (INL) is a measure of the deviation of each individual code from a line drawn from negative full scale ($\frac{1}{2}$ LSB below the first code transition) through positive full scale ($\frac{1}{2}$ LSB above the last code transition). The deviation of any given code from this straight line is measured from the center of that code value.

INTERMODULATION DISTORTION (IMD) is the creation of additional spectral components as a result of two sinusoidal frequencies being applied to the ADC input at the same time. It is defined as the ratio of the power in the both second order (or all four third order) intermodulation products to the sum of the power in both of the original frequencies. IMD is usually expressed in dBFS.

MISSING CODES are those output codes that will never appear at the ADC outputs. The ADC78H89 is ensured not to have any missing codes.

OFFSET ERROR is the deviation of the first code transition (000...000) to (000...001) from the ideal (i.e. GND + 0.5 LSB).

SIGNAL TO NOISE RATIO (SNR) is the ratio, expressed in dB, of the rms value of the input signal to the rms value of the sum of all other spectral components below one-half the sampling frequency, not including harmonics or d.c.

SIGNAL TO NOISE PLUS DISTORTION (S/N+D or SINAD) Is the ratio, expressed in dB, of the rms value of the input signal to the rms value of all of the other spectral components below half the clock frequency, including harmonics but excluding d.c.

SPURIOUS FREE DYNAMIC RANGE (SFDR) is the difference, expressed in dB, between the rms values of the input signal and the peak spurious signal, where a spurious signal is any signal present in the output spectrum that is not present at the input.

TOTAL HARMONIC DISTORTION (THD) is the ratio, expressed in dB, expressed in dB or dBc, of the rms total of the first five harmonic components at the output to the rms level of the input signal frequency as seen at the output. THD is calculated as

$$\text{THD} = 20 \cdot \log_{10} \sqrt{\frac{A_{f_2}^2 + \dots + A_{f_6}^2}{A_{f_1}^2}} \quad (1)$$

where A_{f_1} is the RMS power of the input frequency at the output and A_{f_2} through A_{f_6} are the RMS power in the first 5 harmonic frequencies.

THROUGHPUT TIME is the minimum time required between the start of two successive conversions. It is the acquisition time plus the conversion time. In the case of the ADC78H89, this is 16 SCLK periods.

TYPICAL PERFORMANCE CHARACTERISTICS

$T_A = +25^\circ\text{C}$, $f_{\text{SAMPLE}} = 500 \text{ KSPS}$, $f_{\text{SCLK}} = 8 \text{ MHz}$, $f_{\text{IN}} = 40.2 \text{ kHz}$ unless otherwise stated.

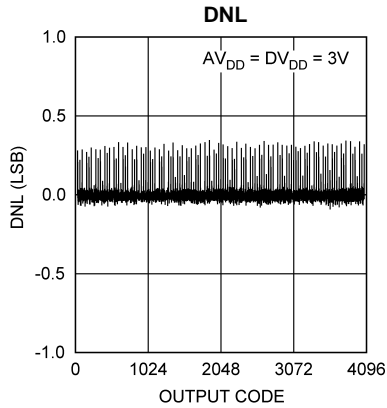

Figure 6.

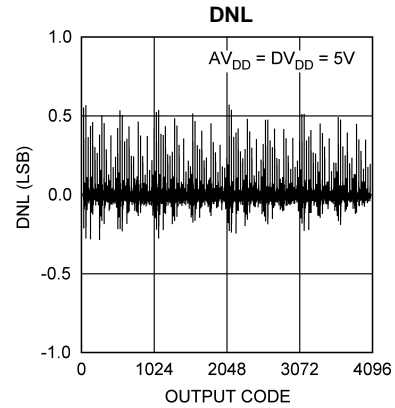

Figure 7.

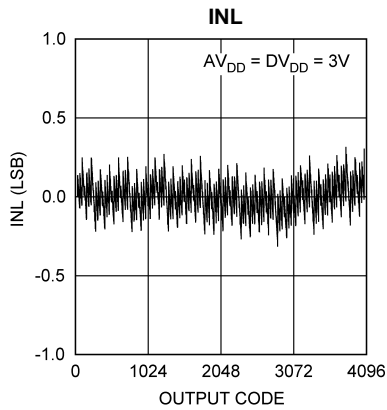

Figure 8.

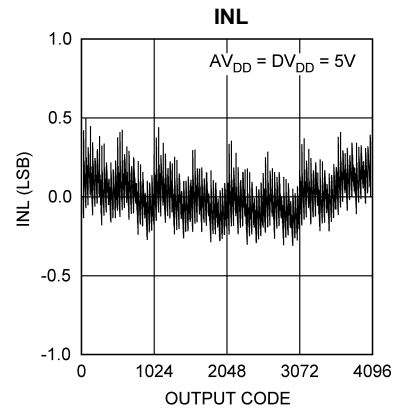

Figure 9.

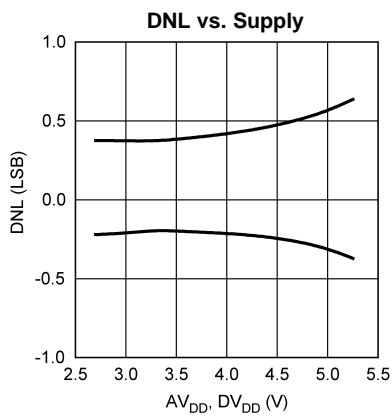

Figure 10.

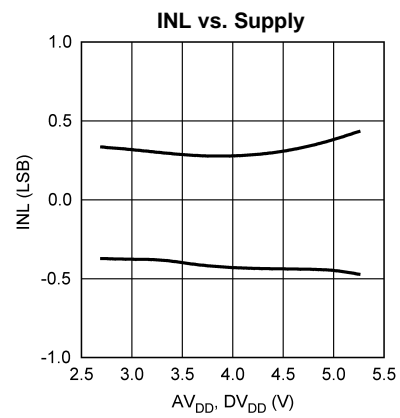

Figure 11.

TYPICAL PERFORMANCE CHARACTERISTICS (continued)

$T_A = +25^\circ\text{C}$, $f_{\text{SAMPLE}} = 500 \text{ KSPS}$, $f_{\text{SCLK}} = 8 \text{ MHz}$, $f_{\text{IN}} = 40.2 \text{ kHz}$ unless otherwise stated.

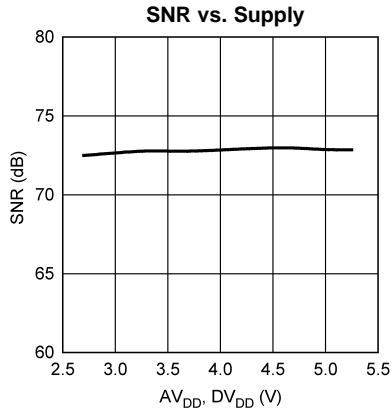

Figure 12.

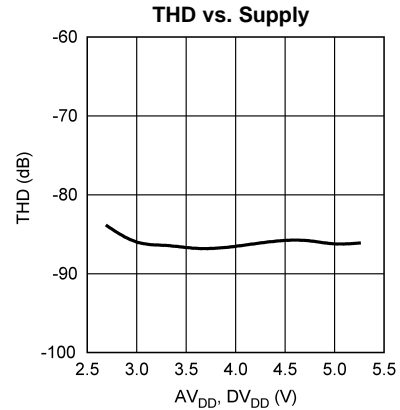

Figure 13.

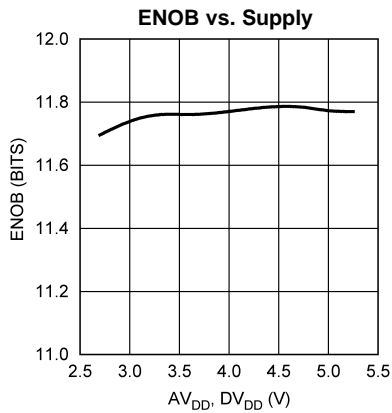

Figure 14.

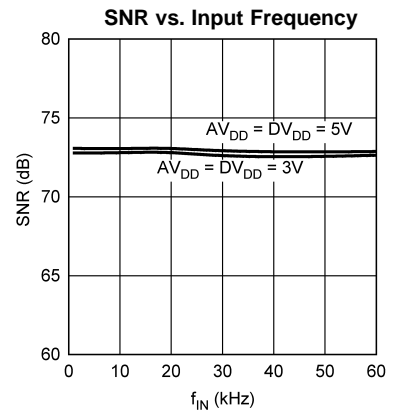

Figure 15.

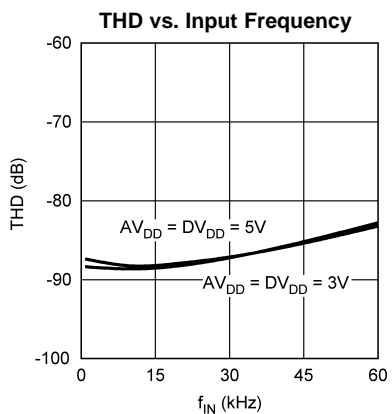

Figure 16.

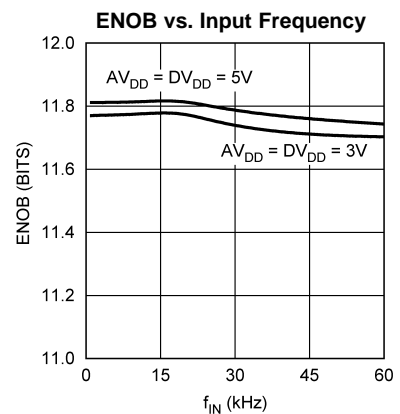

Figure 17.

TYPICAL PERFORMANCE CHARACTERISTICS (continued)

$T_A = +25^\circ\text{C}$, $f_{\text{SAMPLE}} = 500 \text{ KSPS}$, $f_{\text{SCLK}} = 8 \text{ MHz}$, $f_{\text{IN}} = 40.2 \text{ kHz}$ unless otherwise stated.

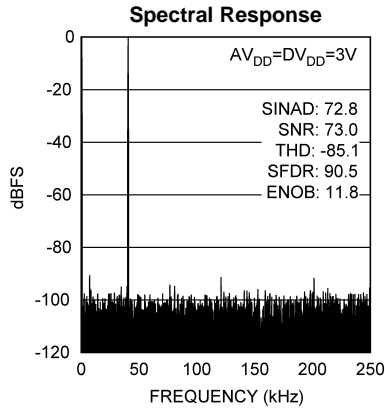

Figure 18.

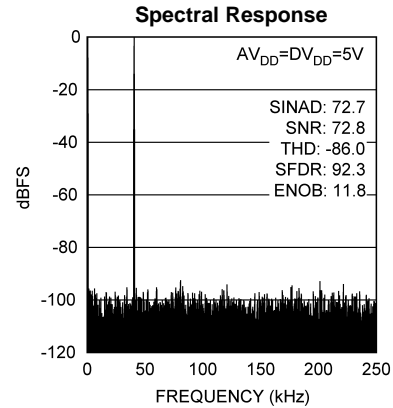

Figure 19.

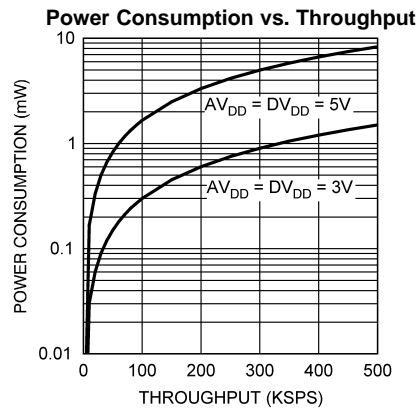

Figure 20.

APPLICATION INFORMATION

USING THE ADC78H89

An operational timing diagram and a serial interface timing diagram for the ADC78H89 are shown in the Timing Diagrams section. \overline{CS} is chip select, which initiates conversions and frames the serial data transfers. SCLK (serial clock) controls both the conversion process and the timing of serial data. DOUT is the serial data output pin, where a conversion result is sent as a serial data stream, MSB first. Data to be written to the ADC78H89's Control Register is placed on DIN, the serial data in pin.

The conversion process and serial data timing are controlled by the SCLK. Each conversion requires 16 SCLK cycles to complete. Conversions are begun by bringing \overline{CS} low. Several conversions can be executed sequentially in a single serial frame, which is defined as the time between falling and rising edges of \overline{CS} . If \overline{CS} is held low continuously, the ADC78H89 will perform conversions continuously.

Each time \overline{CS} goes low, a conversion process is initiated simultaneously with a load of the Control Register. The new contents of the Control Register will affect the next conversion. There is thus a one sample delay between selecting a new input channel and observing the corresponding output.

Basic operation of the ADC78H89 begins with \overline{CS} going low and initiating a conversion process and data transfer. At this time the DOUT pin comes out of the high impedance state. The converter enters track mode at the first falling edge of SCLK after \overline{CS} is brought low, and begins to acquire the input signal. Acquisition of the input signal continues during the first three SCLK cycles after the falling edge of \overline{CS} . This acquisition time is denoted by t_{ACQ} . The converter goes from track to hold mode on the fourth falling edge of SCLK, and the analog input signal is sampled at this time (see Figure 2).

The ADC78H89 supports idling SCLK either high or low between conversions, when \overline{CS} is high. The SCLK may also run continuously while \overline{CS} is high. Regardless of whether the clock is idled, SCLK is internally gated off when \overline{CS} is brought high. If SCLK is in the low state when \overline{CS} goes high, the subsequent fall of \overline{CS} will generate a falling edge of the internal version of SCLK, putting the ADC into the track mode. This is seen as the first falling edge of SCLK. If SCLK is in the high state when \overline{CS} goes high, the ADC enters the track mode on the first falling edge of SCLK after the falling edge of \overline{CS} (see Figure 2). In both cases, a total of sixteen falling edges are required to complete the acquisition and conversion process.

Sixteen SCLK cycles are required to read a complete sample from the ADC78H89. Each bit of the sample (including leading zeros) is valid on subsequent rising edges of SCLK. The ADC78H89 will produce four leading zeros on DOUT, followed by twelve data bits, most significant first. The final data bit, DB0, will be clocked out on the 16th SCLK falling edge, and will be valid on the following rising edge. Depending upon the application, the first edge on SCLK after \overline{CS} goes low may be either a falling edge or a rising edge. If the first SCLK edge after \overline{CS} goes low is a falling edge, all four leading zeros will be valid on the first four rising edges of SCLK. If the first SCLK edge after \overline{CS} goes low is a rising edge, the first leading zero may not be set up in time for a microprocessor or DSP to read it correctly. The remaining data bits are still clocked out on the falling edges of SCLK, so that they are valid on the rising edges of SCLK.

Control information must be written to the Control Register whenever a conversion is performed. Information is written to the Control Register on the first eight rising edges of SCLK of each conversion. It is important that the DIN line is set up with the correct information when reading data from the ADC78H89. The input channel to be sampled in the next conversion process is determined by writing information to the Control Register in the current conversion.

On the rising edges of SCLK after \overline{CS} is brought low, data is loaded through the DIN pin to the Control Register, MSB first. Since the data on the DIN pin is transferred while the conversion data is being read, 16 serial clocks are required for each data transfer. The control register only loads the information on the first 8 rising SCLK edges; DIN is ignored for the last 8 rising edges. Table 1 describes the bit functions, where MSB indicates the first bit of information in the loaded data. At power-up, the control register defaults to all zeros in the bit locations.

Table 1. Control Register Bits

Bit 7 (MSB)	Bit 6	Bit 5	Bit 4	Bit 3	Bit 2	Bit 1	Bit 0
DONTC	DONTC	ADD2	ADD1	ADD0	DONTC	DONTC	DONTC

Table 2. Control Register Bit Descriptions

Bit #:	Symbol:	Description
7, 6, 2, 1, 0	DONTC	Don't care. The value of this bit does not affect the device.
5	ADD2	These three bits determine which input channel will be sampled and converted on the next falling edge of \overline{CS} . The mapping between codes and channels is shown in Table 3 .
4	ADD1	
3	ADD0	

Table 3. Input Channel Selection

ADD2	ADD1	ADD0	Input Channel
0	0	0	AIN1 (Default)
0	0	1	AIN2
0	1	0	AIN3
0	1	1	AIN4
1	0	0	AIN5
1	0	1	AIN6
1	1	0	AIN7
1	1	1	GND

ADC78H89 OPERATION

The ADC78H89 is a successive-approximation analog-to-digital converter designed around a charge-redistribution digital-to-analog converter. Simplified schematics of the ADC78H89 in both track and hold modes are shown in [Figure 21](#) and [Figure 22](#), respectively. In [Figure 21](#), the ADC78H89 is in track mode: switch SW1 connects the sampling capacitor to one of seven analog input channels through the multiplexer, and $\overline{SW2}$ balances the comparator inputs. The ADC78H89 is in this state for the first three SCLK cycles after \overline{CS} is brought low.

The user does not need to worry about any kind of power-up delays or dummy conversions with the ADC78H89. The part is able to acquire input to full resolution in the first conversion immediately following power-up. The first conversion after power up will be that of the first channel.

[Figure 22](#) shows the ADC78H89 in hold mode: switch SW1 connects the sampling capacitor to ground, maintaining the sampled voltage, and switch SW2 unbalances the comparator. The control logic then instructs the charge-redistribution DAC to add or subtract fixed amounts of charge from the sampling capacitor until the comparator is balanced. When the comparator is balanced, the digital word supplied to the DAC is the digital representation of the analog input voltage. The ADC78H89 is in this state for the last thirteen SCLK cycles after \overline{CS} is brought low.

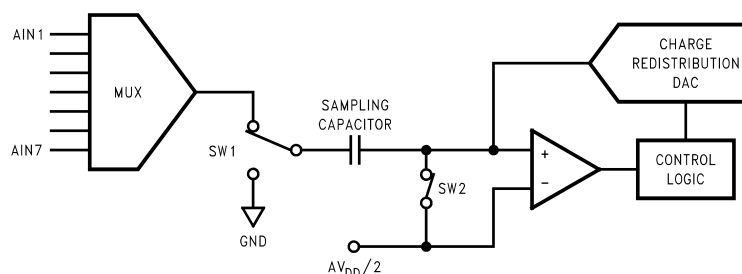

Figure 21. ADC78H89 in Track Mode

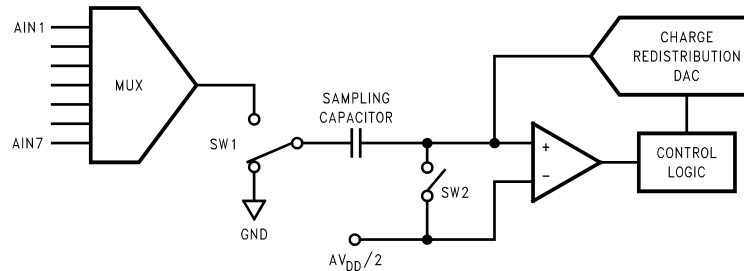

Figure 22. ADC78H89 in Hold Mode

ADC78H89 TRANSFER FUNCTION

The output format of the ADC89H89 is straight binary. Code transitions occur midway between successive integer LSB values. The LSB width for the ADC78H89 is $AV_{DD} / 4096$. The ideal transfer characteristic is shown in Figure 23.

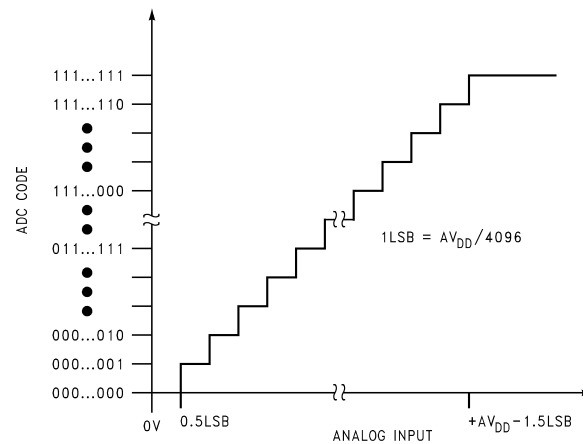

Figure 23. Ideal Transfer Characteristic

TYPICAL APPLICATION CIRCUIT

A typical application of the ADC78H89 is shown in Figure 24. The split analog and digital supplies are both provided in this example by the Texas Instruments LP2950 low-dropout voltage regulator, available in a variety of fixed and adjustable output voltages. The analog supply is bypassed with a capacitor network located close to the ADC78H89. The digital supply is separated from the analog supply by an isolation resistor and conditioned with additional bypass capacitors. The ADC78H89 uses the analog supply (AV_{DD}) as its reference voltage, so it is very important that AV_{DD} be kept as clean as possible. Because of the ADC78H89's low power requirements, it is also possible to use a precision reference as a power supply to maximize performance. The four-wire interface is also shown connected to a microprocessor or DSP.

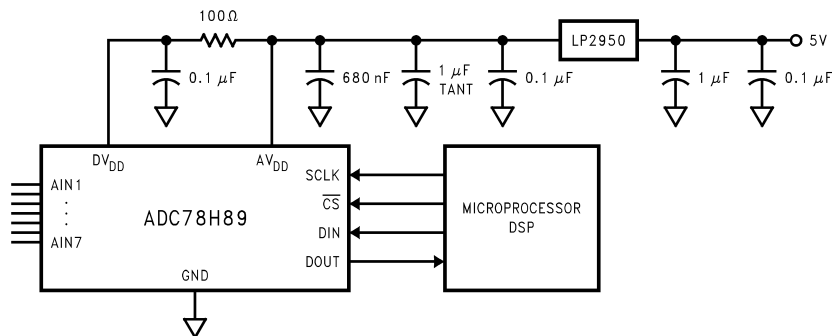

Figure 24. Typical Application Circuit

ANALOG INPUTS

An equivalent circuit for one of the ADC78H89's input channels is shown in Figure 25. At the start of each conversion, one of the ADC78H89's seven channels are selected. Diodes D1 and D2 provide ESD protection for the analog inputs. At no time should an analog input be beyond ($AV_{DD} + 300\text{ mV}$) or ($GND - 300\text{ mV}$), as these ESD diodes will begin conducting, which could cause erratic operation.

The capacitor C1 in Figure 25 typically has a value of 3 pF, and is mainly the package pin capacitance. Resistor R1 is the on resistance of the multiplexer and track / hold switch, and is typically 500 ohms. Capacitor C2 is the ADC78H89 sampling capacitor, and is typically 30 pF. The ADC78H89 will deliver best performance when driven by a low-impedance source to eliminate distortion caused by the charging of the sampling capacitor.

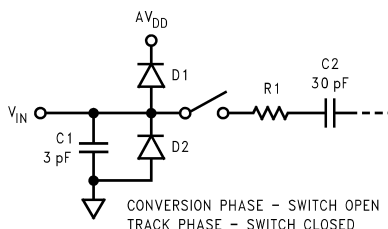

Figure 25. Equivalent Input Circuit

In applications where dynamic performance is critical, the ADC78H89 might need to be driven with a low output-impedance amplifier. In addition, when using the ADC78H89 to sample AC signals, a band-pass or low-pass filter will reduce harmonics and noise, improving dynamic performance.

DIGITAL INPUTS AND OUTPUTS

The ADC78H89's digital inputs (SCLK, \overline{CS} , and DIN) are limited by and cannot exceed the analog supply voltage AV_{DD} . The digital input pins are not prone to latch-up; SCLK, \overline{CS} , and DIN may be asserted before DV_{DD} without any risk.

POWER SUPPLY CONSIDERATIONS

The ADC78H89 has two supplies, although they could both have the same potential. There are two major power supply concerns with this product. They are relative power supply levels, including power-on sequencing, and the effect of digital supply noise on the analog supply.

Power Management

The ADC78H89 is a dual-supply device. These two supplies share ESD resources, and thus care must be exercised to ensure that the power supplies are applied in the correct sequence. To avoid turning on the ESD diodes, the digital supply (DV_{DD}) cannot exceed the analog supply (AV_{DD}) by more than 300 mV. The ADC78H89's analog power supply must, therefore, be applied before (or concurrently with) the digital power supply.

The ADC78H89 is fully powered-up whenever \overline{CS} is low, and fully powered-down whenever \overline{CS} is high, with one exception: the ADC78H89 automatically enters power-down mode between the 16th falling edge of a conversion and the 1st falling edge of the subsequent conversion (see [Figure 2](#)).

The ADC78H89 can perform multiple conversions back to back; each conversion requires 16 SCLK cycles. The ADC78H89 will perform conversions continuously as long as \overline{CS} is held low.

The user may trade off throughput for power consumption by simply performing fewer conversions per unit time. The Power Consumption vs. Sample Rate curve in the Typical Performance Curves section shows the typical power consumption of the ADC78H89 versus throughput. To calculate the power consumption, simply multiply the fraction of time spent in the normal mode by the normal mode power consumption (8.3 mW with $AV_{DD} = DV_{DD} = +3.6V$, for example), and add the fraction of time spent in shutdown mode multiplied by the shutdown mode power dissipation (0.3 mW with $AV_{DD} = DV_{DD} = +3.6V$).

Power Supply Noise Considerations

The charging of any output load capacitance requires current from the digital supply, DV_{DD} . The current pulses required from the supply to charge the output capacitance will cause voltage variations on the digital supply. If these variations are large enough, they could cause degrade SNR and SINAD performance of the ADC. Furthermore, if the analog and digital supplies are tied directly together, the noise on the digital supply will be coupled directly into the analog supply, causing greater performance degradation than noise on the digital supply. Furthermore, discharging the output capacitance when the digital output goes from a logic high to a logic low will dump current into the die substrate, which is resistive. Load discharge currents will cause "ground bounce" noise in the substrate that will degrade noise performance if that current is large enough. The larger is the output capacitance, the more current flows through the die substrate and the greater is the noise coupled into the analog channel, degrading noise performance.

The first solution is to decouple the analog and digital supplies from each other, or use separate supplies for them, to keep digital noise out of the analog supply. To keep noise out of the digital supply, keep the output load capacitance as small as practical. If the load capacitance is greater than 25 pF, use a 100 Ω series resistor at the ADC output, located as close to the ADC output pin as practical. This will limit the charge and discharge current of the output capacitance and improve noise performance.

REVISION HISTORY

Changes from Revision C (March 2013) to Revision D	Page
<hr/> <ul style="list-style-type: none">• Changed layout of National Data Sheet to TI format	<hr/> 16

PACKAGING INFORMATION

Orderable Device	Status (1)	Package Type	Package Drawing	Pins	Package Qty	Eco Plan (2)	Lead/Ball Finish	MSL Peak Temp (3)	Op Temp (°C)	Device Marking (4/5)	Samples
ADC78H89CIMT/NOPB	ACTIVE	TSSOP	PW	16	92	Green (RoHS & no Sb/Br)	CU SN	Level-1-260C-UNLIM	-40 to 85	78H89 CIMT	Samples
ADC78H89CIMTX/NOPB	ACTIVE	TSSOP	PW	16	2500	Green (RoHS & no Sb/Br)	CU SN	Level-1-260C-UNLIM	-40 to 85	78H89 CIMT	Samples

(1) The marketing status values are defined as follows:

ACTIVE: Product device recommended for new designs.

LIFEBUY: TI has announced that the device will be discontinued, and a lifetime-buy period is in effect.

NRND: Not recommended for new designs. Device is in production to support existing customers, but TI does not recommend using this part in a new design.

PREVIEW: Device has been announced but is not in production. Samples may or may not be available.

OBSELETE: TI has discontinued the production of the device.

(2) Eco Plan - The planned eco-friendly classification: Pb-Free (RoHS), Pb-Free (RoHS Exempt), or Green (RoHS & no Sb/Br) - please check <http://www.ti.com/productcontent> for the latest availability information and additional product content details.

TBD: The Pb-Free/Green conversion plan has not been defined.

Pb-Free (RoHS): TI's terms "Lead-Free" or "Pb-Free" mean semiconductor products that are compatible with the current RoHS requirements for all 6 substances, including the requirement that lead not exceed 0.1% by weight in homogeneous materials. Where designed to be soldered at high temperatures, TI Pb-Free products are suitable for use in specified lead-free processes.

Pb-Free (RoHS Exempt): This component has a RoHS exemption for either 1) lead-based flip-chip solder bumps used between the die and package, or 2) lead-based die adhesive used between the die and leadframe. The component is otherwise considered Pb-Free (RoHS compatible) as defined above.

Green (RoHS & no Sb/Br): TI defines "Green" to mean Pb-Free (RoHS compatible), and free of Bromine (Br) and Antimony (Sb) based flame retardants (Br or Sb do not exceed 0.1% by weight in homogeneous material)

(3) MSL, Peak Temp. -- The Moisture Sensitivity Level rating according to the JEDEC industry standard classifications, and peak solder temperature.

(4) There may be additional marking, which relates to the logo, the lot trace code information, or the environmental category on the device.

(5) Multiple Device Markings will be inside parentheses. Only one Device Marking contained in parentheses and separated by a "~" will appear on a device. If a line is indented then it is a continuation of the previous line and the two combined represent the entire Device Marking for that device.

Important Information and Disclaimer: The information provided on this page represents TI's knowledge and belief as of the date that it is provided. TI bases its knowledge and belief on information provided by third parties, and makes no representation or warranty as to the accuracy of such information. Efforts are underway to better integrate information from third parties. TI has taken and continues to take reasonable steps to provide representative and accurate information but may not have conducted destructive testing or chemical analysis on incoming materials and chemicals. TI and TI suppliers consider certain information to be proprietary, and thus CAS numbers and other limited information may not be available for release.

In no event shall TI's liability arising out of such information exceed the total purchase price of the TI part(s) at issue in this document sold by TI to Customer on an annual basis.

TAPE AND REEL INFORMATION



QUADRANT ASSIGNMENTS FOR PIN 1 ORIENTATION IN TAPE



*All dimensions are nominal

Device	Package Type	Package Drawing	Pins	SPQ	Reel Diameter (mm)	Reel Width W1 (mm)	A0 (mm)	B0 (mm)	K0 (mm)	P1 (mm)	W (mm)	Pin1 Quadrant
ADC78H89CIMTX/NOPB	TSSOP	PW	16	2500	330.0	12.4	6.95	5.6	1.6	8.0	12.0	Q1

TAPE AND REEL BOX DIMENSIONS



*All dimensions are nominal

Device	Package Type	Package Drawing	Pins	SPQ	Length (mm)	Width (mm)	Height (mm)
ADC78H89CIMTX/NOPB	TSSOP	PW	16	2500	367.0	367.0	35.0

PW (R-PDSO-G16)

PLASTIC SMALL OUTLINE

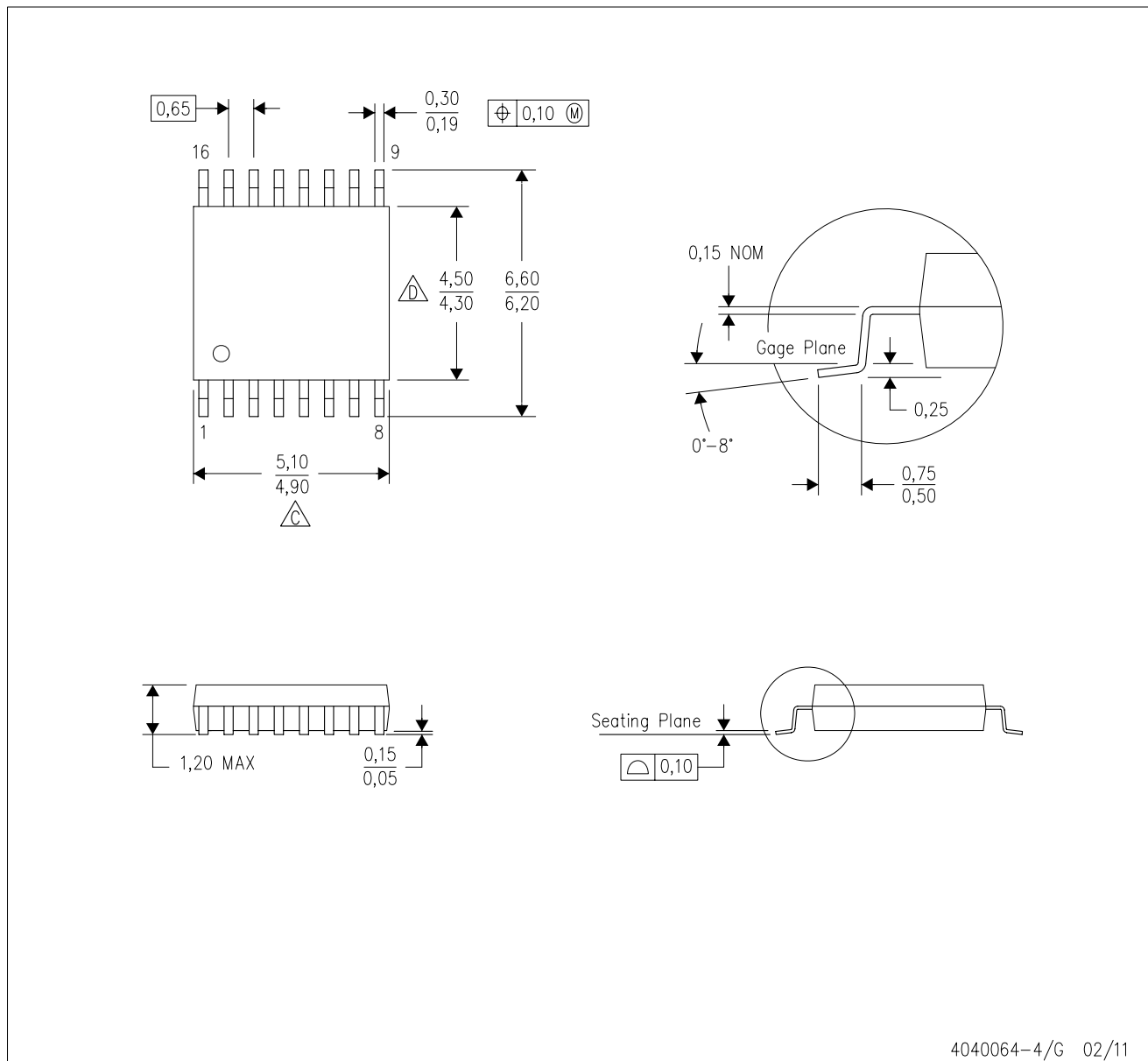

4040064-4/G 02/11

- NOTES:
- A. All linear dimensions are in millimeters. Dimensioning and tolerancing per ASME Y14.5M-1994.
 - B. This drawing is subject to change without notice.
 - C. Body length does not include mold flash, protrusions, or gate burrs. Mold flash, protrusions, or gate burrs shall not exceed 0,15 each side.
 - D. Body width does not include interlead flash. Interlead flash shall not exceed 0,25 each side.
 - E. Falls within JEDEC MO-153

IMPORTANT NOTICE

Texas Instruments Incorporated and its subsidiaries (TI) reserve the right to make corrections, enhancements, improvements and other changes to its semiconductor products and services per JESD46, latest issue, and to discontinue any product or service per JESD48, latest issue. Buyers should obtain the latest relevant information before placing orders and should verify that such information is current and complete. All semiconductor products (also referred to herein as "components") are sold subject to TI's terms and conditions of sale supplied at the time of order acknowledgment.

TI warrants performance of its components to the specifications applicable at the time of sale, in accordance with the warranty in TI's terms and conditions of sale of semiconductor products. Testing and other quality control techniques are used to the extent TI deems necessary to support this warranty. Except where mandated by applicable law, testing of all parameters of each component is not necessarily performed.

TI assumes no liability for applications assistance or the design of Buyers' products. Buyers are responsible for their products and applications using TI components. To minimize the risks associated with Buyers' products and applications, Buyers should provide adequate design and operating safeguards.

TI does not warrant or represent that any license, either express or implied, is granted under any patent right, copyright, mask work right, or other intellectual property right relating to any combination, machine, or process in which TI components or services are used. Information published by TI regarding third-party products or services does not constitute a license to use such products or services or a warranty or endorsement thereof. Use of such information may require a license from a third party under the patents or other intellectual property of the third party, or a license from TI under the patents or other intellectual property of TI.

Reproduction of significant portions of TI information in TI data books or data sheets is permissible only if reproduction is without alteration and is accompanied by all associated warranties, conditions, limitations, and notices. TI is not responsible or liable for such altered documentation. Information of third parties may be subject to additional restrictions.

Resale of TI components or services with statements different from or beyond the parameters stated by TI for that component or service voids all express and any implied warranties for the associated TI component or service and is an unfair and deceptive business practice. TI is not responsible or liable for any such statements.

Buyer acknowledges and agrees that it is solely responsible for compliance with all legal, regulatory and safety-related requirements concerning its products, and any use of TI components in its applications, notwithstanding any applications-related information or support that may be provided by TI. Buyer represents and agrees that it has all the necessary expertise to create and implement safeguards which anticipate dangerous consequences of failures, monitor failures and their consequences, lessen the likelihood of failures that might cause harm and take appropriate remedial actions. Buyer will fully indemnify TI and its representatives against any damages arising out of the use of any TI components in safety-critical applications.

In some cases, TI components may be promoted specifically to facilitate safety-related applications. With such components, TI's goal is to help enable customers to design and create their own end-product solutions that meet applicable functional safety standards and requirements. Nonetheless, such components are subject to these terms.

No TI components are authorized for use in FDA Class III (or similar life-critical medical equipment) unless authorized officers of the parties have executed a special agreement specifically governing such use.

Only those TI components which TI has specifically designated as military grade or "enhanced plastic" are designed and intended for use in military/aerospace applications or environments. Buyer acknowledges and agrees that any military or aerospace use of TI components which have **not** been so designated is solely at the Buyer's risk, and that Buyer is solely responsible for compliance with all legal and regulatory requirements in connection with such use.

TI has specifically designated certain components as meeting ISO/TS16949 requirements, mainly for automotive use. In any case of use of non-designated products, TI will not be responsible for any failure to meet ISO/TS16949.

Products

Audio	www.ti.com/audio
Amplifiers	amplifier.ti.com
Data Converters	dataconverter.ti.com
DLP® Products	www.dlp.com
DSP	dsp.ti.com
Clocks and Timers	www.ti.com/clocks
Interface	interface.ti.com
Logic	logic.ti.com
Power Mgmt	power.ti.com
Microcontrollers	microcontroller.ti.com
RFID	www.ti-rfid.com
OMAP Applications Processors	www.ti.com/omap
Wireless Connectivity	www.ti.com/wirelessconnectivity

Applications

Automotive and Transportation	www.ti.com/automotive
Communications and Telecom	www.ti.com/communications
Computers and Peripherals	www.ti.com/computers
Consumer Electronics	www.ti.com/consumer-apps
Energy and Lighting	www.ti.com/energy
Industrial	www.ti.com/industrial
Medical	www.ti.com/medical
Security	www.ti.com/security
Space, Avionics and Defense	www.ti.com/space-avionics-defense
Video and Imaging	www.ti.com/video

TI E2E Community

e2e.ti.com