



为您的产品保驾护航

PRODUCT DATASHEET

Electro-Static Discharge

JET23-xxV-C2 ESD

Features

- Package: SOT-23
- 300W peak pulse power (8/20 μ s)
- Protects two bi-directional lines
- Ultra low leakage: nA level
- Operating voltage: 3.3V,5V,12V,15V,24,32V,36V
- Low clamping voltage
- Complies with following standards:
 - IEC 61000-4-2 (ESD) immunity test
 - Air discharge: ± 30 kV
 - Contact discharge: ± 30 kV
- RoHS compliant

Applications

- Cellular Handsets and Accessories
- Notebooks and Handhelds
- Portable Instrumentation
- Set Top Box
- Industrial Controls
- Server and Desktop PC

Pin Description

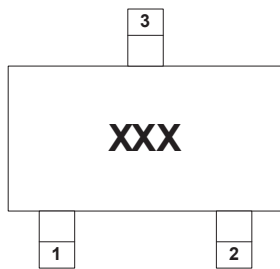

Schematic Diagram

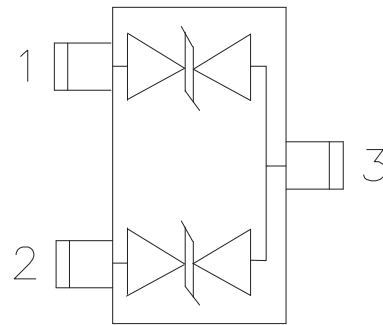

Limiting Values($T_A = 25\text{ }^\circ\text{C}$, unless otherwise specified)

Symbol	Parameter	Conditions	Value	Unit
V _{ESD}	Electrostatic Discharge Voltage	IEC 61000-4-2;Contact Discharge	± 30	kV
		IEC 61000-4-2;Air Discharge	± 30	kV
P _{PK}	Peak Pulse Power	t _P =8/20 μ s	300	W
T _J	Operating Temperature Range	-	-55 to +125	$^\circ\text{C}$
T _{stg}	Storage Temperature Range	-	-55 to +150	$^\circ\text{C}$

Electrical Characteristics($T_A = 25\text{ }^\circ\text{C}$, unless otherwise specified)

Part NO.	JET23-3.3V-C2					
Symbol	Parameter	Conditions	Min	Typ.	Max	Unit
V_{RWM}	Reverse Working Voltage	$T_A=25^\circ\text{C}$	-	-	3.3	V
V_{BR}	Breakdown Voltage	$I_T=1\text{mA}$	3.8	-	-	V
I_R	Reverse Leakage Current	$V_{RWM}=3.3\text{V}$	-	-	1.0	μA
V_C	Clamping Voltage	$I_{PP}=1\text{A}(8\times 20\mu\text{s pulse})$	-	-	6	V
V_C	Clamping Voltage	$I_{PP}=25\text{A}(8\times 20\mu\text{s pulse})$	-	-	12	V
I_{PP}	Peak Pulse Current	$t_P=8/20\mu\text{s}$	-	-	25	A
C_J	Junction Capacitance	$V_R=0\text{V}, f=1\text{ MHz}, \text{Pin 1 to Pin 3}$ or Pin 2 to Pin 3	-	-	100	pF

Part NO.	JET23-5V-C2					
Symbol	Parameter	Conditions	Min	Typ.	Max	Unit
V_{RWM}	Reverse Working Voltage	$T_A=25^\circ\text{C}$	-	-	5	V
V_{BR}	Breakdown Voltage	$I_T=1\text{mA}$	6	-	-	V
I_R	Reverse Leakage Current	$V_{RWM}=5\text{V}$	-	-	1.0	μA
V_C	Clamping Voltage	$I_{PP}=1\text{A}(8\times 20\mu\text{s pulse})$	-	-	8	V
V_C	Clamping Voltage	$I_{PP}=20\text{A}(8\times 20\mu\text{s pulse})$	-	-	15	V
I_{PP}	Peak Pulse Current	$t_P=8/20\mu\text{s}$	-	-	20	A
C_J	Junction Capacitance	$V_R=0\text{V}, f=1\text{ MHz}, \text{Pin 1 to Pin 3}$ or Pin 2 to Pin 3	-	-	80	pF

Part NO.	JET23-12V-C2					
Symbol	Parameter	Conditions	Min	Typ.	Max	Unit
V_{RWM}	Reverse Working Voltage	$T_A=25^\circ\text{C}$	-	-	12	V
V_{BR}	Breakdown Voltage	$I_T=1\text{mA}$	13.3	-	-	V
I_R	Reverse Leakage Current	$V_{RWM}=12\text{V}$	-	-	0.5	μA
V_C	Clamping Voltage	$I_{PP}=1\text{A}(8\times 20\mu\text{s pulse})$	-	-	18	V
V_C	Clamping Voltage	$I_{PP}=12\text{A}(8\times 20\mu\text{s pulse})$	-	-	25	V
I_{PP}	Peak Pulse Current	$t_P=8/20\mu\text{s}$	-	-	12	A
C_J	Junction Capacitance	$V_R=0\text{V}, f=1\text{ MHz}, \text{Pin 1 to Pin 3}$ or Pin 2 to Pin 3	-	-	50	pF

Part NO.	JET23-15V-C2					
Symbol	Parameter	Conditions	Min	Typ.	Max	Unit
V _{RWM}	Reverse Working Voltage	T _A =25°C	-	-	15	V
V _{BR}	Breakdown Voltage	I _T =1mA	16.7	-	-	V
I _R	Reverse Leakage Current	V _{RWM} =15V	-	-	0.5	μA
V _C	Clamping Voltage	I _{PP} =1A(8x20μs pulse)	-	-	20	V
V _C	Clamping Voltage	I _{PP} =8A(8x20μs pulse)	-	-	37.5	V
I _{pp}	Peak Pulse Current	t _p =8/20μs	-	-	8	A
C _J	Junction Capacitance	V _R =0V,f=1 MHz,Pin 1 to Pin 3 or Pin 2 to Pin 3	-	-	40	pF

Part NO.	JET23-24V-C2					
Symbol	Parameter	Conditions	Min	Typ.	Max	Unit
V _{RWM}	Reverse Working Voltage	T _A =25°C	-	-	24	V
V _{BR}	Breakdown Voltage	I _T =1mA	27	-	-	V
I _R	Reverse Leakage Current	V _{RWM} =24V	-	-	0.2	μA
V _C	Clamping Voltage	I _{PP} =1A(8x20μs pulse)	-	-	40	V
V _C	Clamping Voltage	I _{PP} =5A(8x20μs pulse)	-	-	60	V
I _{pp}	Peak Pulse Current	t _p =8/20μs	-	-	5	A
C _J	Junction Capacitance	V _R =0V,f=1 MHz,Pin 1 to Pin 3 or Pin 2 to Pin 3	-	15	30	pF

Part NO.	JET23-32V-C2					
Symbol	Parameter	Conditions	Min	Typ.	Max	Unit
V _{RWM}	Reverse Working Voltage	T _A =25°C	-	-	32	V
V _{BR}	Breakdown Voltage	I _T =1mA	35.6	-	-	V
I _R	Reverse Leakage Current	V _{RWM} =36V	-	-	0.2	μA
V _C	Clamping Voltage	I _{PP} =1A(8x20μs pulse)	-	-	45	V
V _C	Clamping Voltage	I _{PP} =4.5A(8x20μs pulse)	-	-	67	V
I _{pp}	Peak Pulse Current	t _p =8/20μs	-	-	4	A
C _J	Junction Capacitance	V _R =0V,f=1 MHz,Pin 1 to Pin 3 or Pin 2 to Pin 3	-	15	25	pF

Part NO.	JET23-36V-C2					
Symbol	Parameter	Conditions	Min	Typ.	Max	Unit
V _{RWM}	Reverse Working Voltage	T _A =25°C	-	-	36	V
V _{BR}	Breakdown Voltage	I _T =1mA	38	-	-	V
I _R	Reverse Leakage Current	V _{RWM} =36V	-	-	0.2	μA
V _C	Clamping Voltage	I _{PP} =1A(8x20μs pulse)	-	-	50	V
V _C	Clamping Voltage	I _{PP} =4A(8x20μs pulse)	-	-	75	V
I _{pp}	Peak Pulse Current	t _p =8/20μs	-	-	4	A
C _J	Junction Capacitance	V _R =0V,f=1 MHz,Pin 1 to Pin 3 or Pin 2 to Pin 3	-	12	20	pF

Typical Characteristics

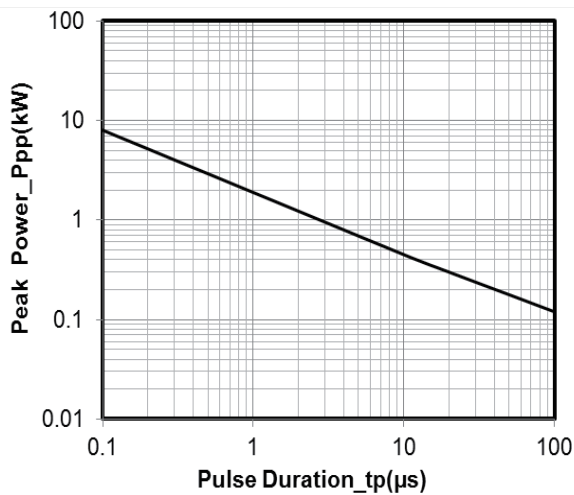

Peak Pulse Power vs. Pulse Time

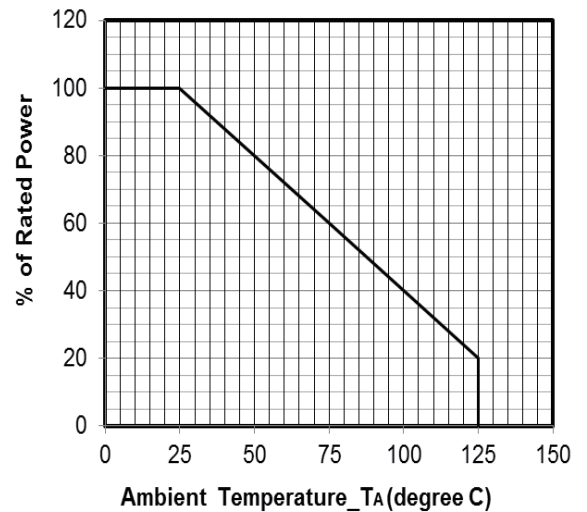

Power Derating Curve

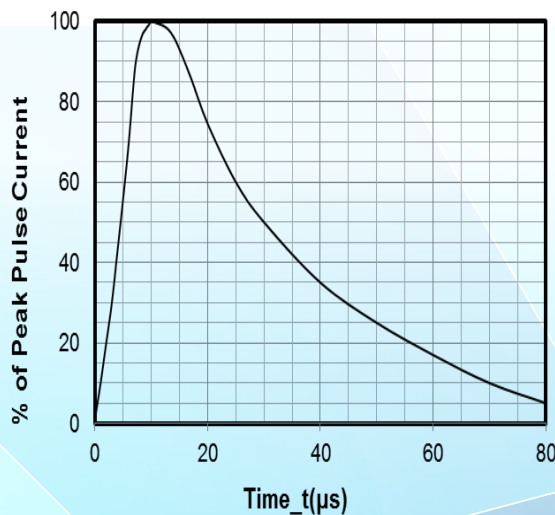

8 X 20 μs Pulse Waveform

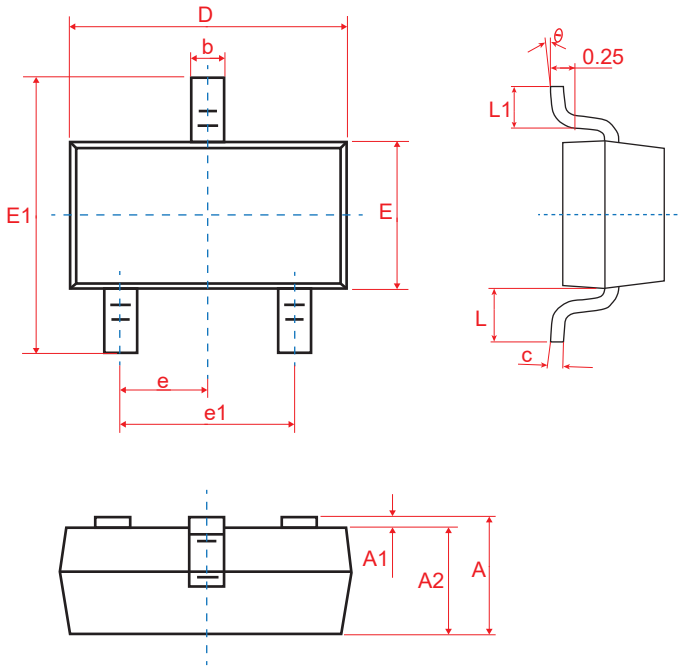
Physical Dimensions(mm.)

Symbol	Dimensions In Millimeters		Dimensions In Inches	
	Min	Max	Min	Max
A	0.90	1.15	0.035	0.045
A1	0.00	0.10	0.000	0.004
A2	0.90	1.05	0.035	0.041
b	0.30	0.50	0.012	0.020
c	0.08	0.15	0.003	0.006
D	2.80	3.00	0.110	0.118
E	1.20	1.40	0.047	0.055
E1	2.25	2.55	0.089	0.100
e	0.95 TYP		0.037 TYP	
e1	1.80	2.00	0.071	0.079
L	0.55 REF		0.022 REF	
L1	0.30	0.50	0.012	0.020
e	0°	8°	0°	8°

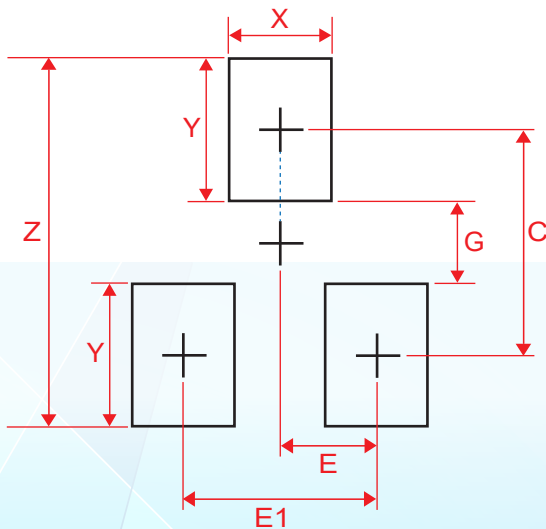
Suggested Land Pattern

Symbol	Dimensions	
	Inches	Millimeters
C	0.087	2.20
E	0.037	0.95
E1	0.075	1.90
G	0.031	0.80
X	0.039	1.00
Y	0.055	1.40
Z	0.141	3.60

Packaging Quantity

Part Number	Delivery Form	Delivery Quantity
JET23-xxV-C2	7"T&R	3,000

Soldering Parameters

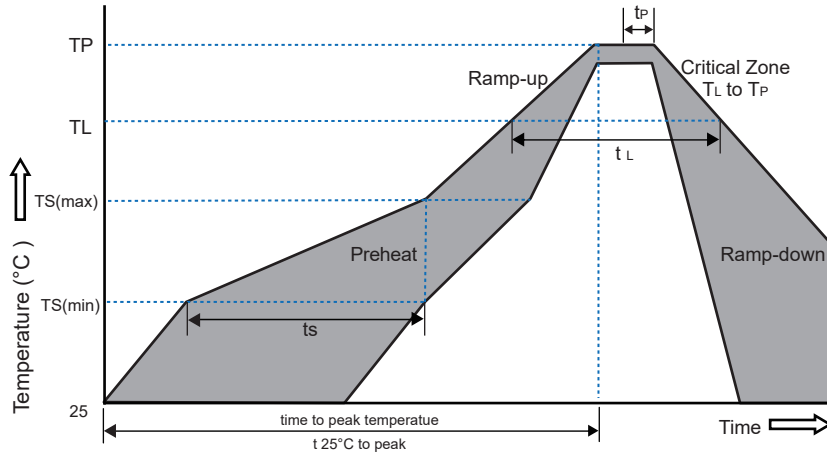

Reflow Condition		Pb-Free Assembly
Pre-heat	-Temperature Min($T_{s(min)}$)	+150°C
	-Temperature Max($T_{s(max)}$)	+200°C
	-Time(Min to Max)(t_s)	60~180 secs.
Average ramp up rate (Liquid us Temp(T_L) to peak)		3°C/sec. Max
Ts(max) to T_L - Ramp-up Rate		3°C/sec. Max
Reflow	-Temperature(T_L)(Liquid us)	+217°C
	-Temperature (t_L)	60~150 secs.
Peak Temp (T_P)		+260(+0/-5)°C
Time within 5°C of actual Peak Temp (t_p)		30 secs. Max
Ramp-down Rate		6°C/sec. Max
xTime 25°C to Peak Temp (TP)		8 min. Max
Do not exceed		+260°C

Part Number System

JE T23 - xxV-C 2

2=2 line

C=Bi-directional
Blank=Uni-directional

Working Voltage: xxV

SOT-23

JDT ESD