

3-61668-1 ✓ ACTIVE

AMPMODU | UTILUX CR

TE Internal #: 3-61668-1

Hermaphroditic Contact, Tin, Snap-In Contact Retention, 24 – 18

AWG Wire Size, .2 – .8 mm² Wire Size, Crimp, Brass, Signal, UTILUX

CR

[View on TE.com >](#)



Connectors > Contacts > Connector Contacts

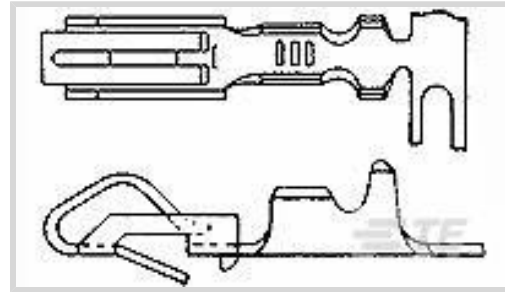

Contact Type: **Hermaphroditic**

Contact Mating Area Plating Material: **Tin**

Contact Retention Type Within Housing: **Snap-In**

Wire Size: **.2 – .8 mm²**

Features

Contact Features

PCB Contact Termination Area Plating Material Thickness	2.032 – 5.08 µm[80 – 200 µin]
Contact Mating Area Plating Material Thickness	2.032 – 5.08 µm[80 – 200 µin]
Contact Orientation	Straight
Contact Underplating Material	Nickel
PCB Contact Termination Area Plating Material	Tin
Contact Type	Hermaphroditic
Contact Mating Area Plating Material	Tin
Contact Base Material	Brass
Contact Current Rating (Max)	6 A

Termination Features

Termination Method to Wire & Cable	Crimp
Product Terminates To	Wire & Cable

Mechanical Attachment

Wire Insulation Support	With
PCB Mount Retention	Without
Contact Retention Type Within Housing	Snap-In

Dimensions

Compatible Insulation Diameter Range	2.79 mm[.11 in]
Wire Size	.2 – .8 mm ²



Usage Conditions

Operating Temperature Range	-55 – 105 °C[-55 – 105 °F]
-----------------------------	----------------------------

Operation/Application

Circuit Application	Signal
---------------------	--------

Packaging Features

Packaging Quantity	6000
Packaging Method	Reel

Product Compliance

[For compliance documentation, visit the product page on TE.com>](#)

EU RoHS Directive 2011/65/EU	Compliant
EU ELV Directive 2000/53/EC	Compliant
China RoHS 2 Directive MIIT Order No 32, 2016	No Restricted Materials Above Threshold
EU REACH Regulation (EC) No. 1907/2006	Current ECHA Candidate List: JUNE 2024 (241) Candidate List Declared Against: JUNE 2024 (241) Does not contain REACH SVHC
Halogen Content	Low Halogen - Br, Cl, F, I < 900 ppm per homogenous material. Also BFR/CFR/PVC Free
Solder Process Capability	Not applicable for solder process capability

Product Compliance Disclaimer

This information is provided based on reasonable inquiry of our suppliers and represents our current actual knowledge based on the information they provided. This information is subject to change. The part numbers that TE has identified as EU RoHS compliant have a maximum concentration of 0.1% by weight in homogenous materials for lead, hexavalent chromium, mercury, PBB, PBDE, DBP, BBP, DEHP, DIBP, and 0.01% for cadmium, or qualify for an exemption to these limits as defined in the Annexes of Directive 2011/65/EU (RoHS2). Finished electrical and electronic equipment products will be CE marked as required by Directive 2011/65/EU. Components may not be CE marked. Additionally, the part numbers that TE has identified as EU ELV compliant have a maximum concentration of 0.1% by weight in homogenous materials for lead, hexavalent chromium, and mercury, and 0.01% for cadmium, or qualify for an exemption to these limits as defined in the Annexes of Directive 2000/53/EC (ELV). Regarding the REACH Regulation, the information TE provides on SVHC in articles for this part number is based on the latest European Chemicals Agency (ECHA) 'Guidance on requirements for substances in articles' posted at this URL: <https://echa.europa.eu/guidance-documents/guidance-on-reach>

Compatible Parts



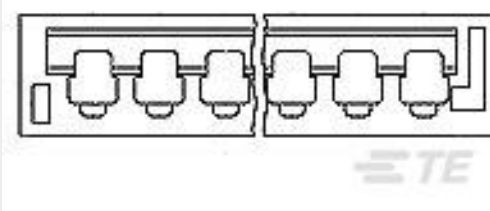

TE Part # 2151033-1
OCEAN-2.0-APPLICATOR-S-070F100F-RSM



TE Part # 640136-2
02P EDGE CONN HSG, BIF-LEAF

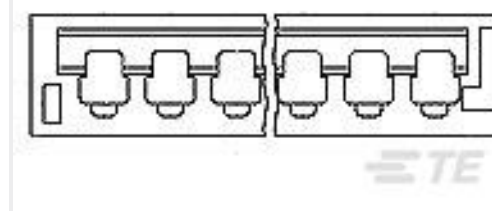

TE Part # 58614-1
PROCRIMP, HT&D SL156



TE Part # 640136-6
06P EDGE CONN HSG, BIF-LEAF

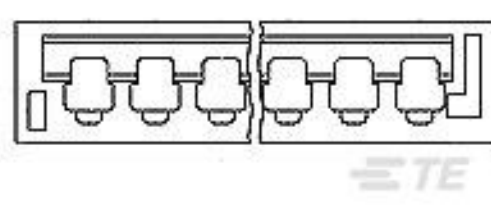

TE Part # 640136-4
04P EDGE CONN HSG, BIF-LEAF



KIT
REPRESENTATION ONLY

TE Part # 7-2151033-7
OCEAN_2.0_SPARE_PART_KIT-070F100F

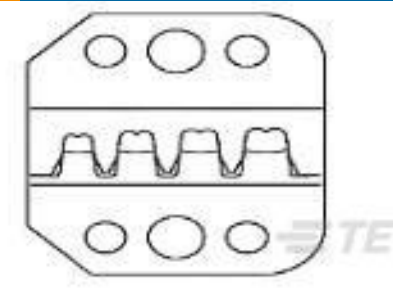

TE Part # 58614-2
PROCRIMP, DIE, SL156



TE Part # 91597-1
CCII SL-156 REC 24-18 ASSY

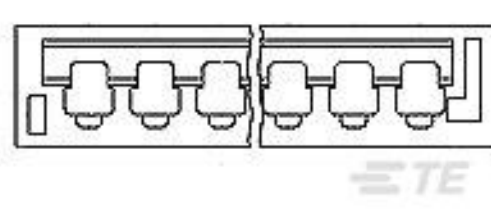

TE Part # 640136-8
08P EDGE CONN HSG, BIF-LEAF

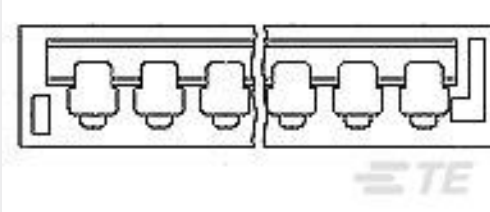

TE Part # 640136-9
09P EDGE CONN HSG, BIF-LEAF



TE Part # 2151033-2
OCEAN-2.0-APPLICATOR-S-070F100FA-RSA



TE Part # 2305570-1
Strip Terminal Cutter-Side Feed-No Crimp



TE Part # 2479636-1
EXTRACTION TOOL



TE Part # 5-2151033-1
OCEAN-2.0-APPLICATOR-S-070F100F-RSM



TE Part # 5-2151033-2
OCEAN-2.0-APPLICATOR-S-070F100FA-RSA



KIT
REPRESENTATION ONLY

TE Part # 7-2266602-7
OCEAN_2.0_SPARE_PART_KIT-070F100F

Also in the Series | UTILUX CR



Compression Connectors(4)

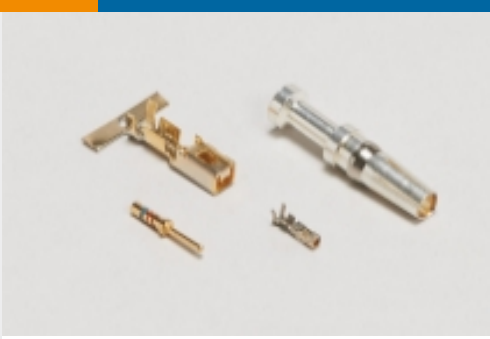

Connector Contacts(4)

Customers Also Bought



TE Part #1-2834074-2
2P PLUG, MINIATURE WATERPROOF
CONN.WHITE



TE Part #1-6609115-2
3EGG1-2 S0=F7385D



TE Part #6-6609107-1
PS000SSXB=C1120



TE Part #20014203-08
PRESS XDCR M323M-000004-070BG

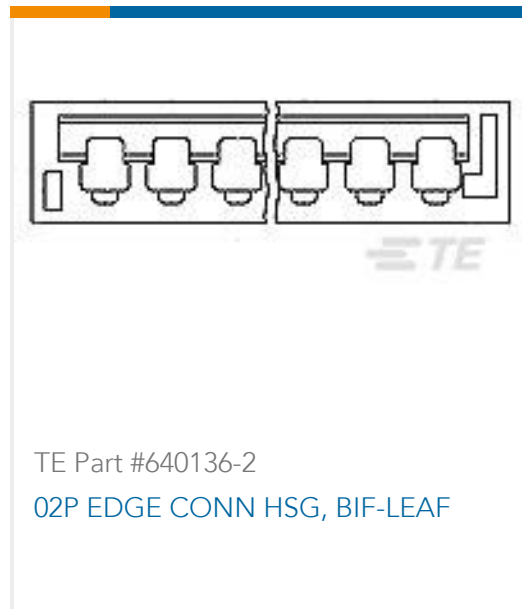

TE Part #640136-2
02P EDGE CONN HSG, BIF-LEAF



TE Part #20009605-03
FX292X-040B-0100-L



TE Part #2151865-1
OCEAN-2.0-APPLICATOR-S-050F057F-
RSM



TE Part #3-2176421-0
TLRP 2512 2.0W R068 1% 25PPM 4K RL



TE Part #3-2176421-5
TLRP 2512 2.0W R090 1% 25PPM 4K RL

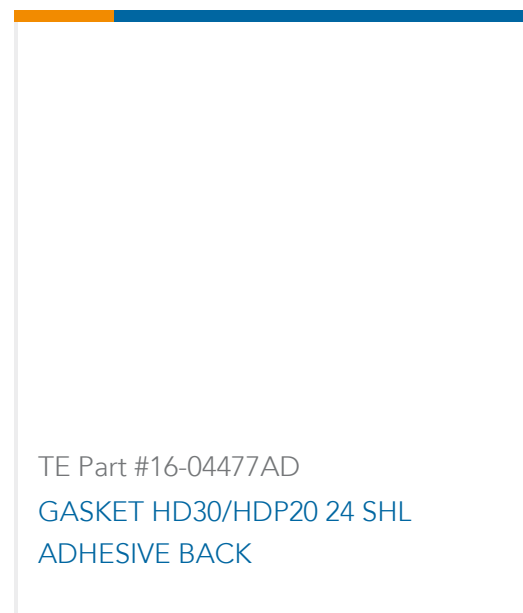

TE Part #16-04477AD
GASKET HD30/HDP20 24 SHL
ADHESIVE BACK

Documents

Product Drawings

[BIF-LEAF CONT CR/SNAP SN/BR](#)

English

CAD Files

Customer View Model

[ENG_CVM_3-61668-1_AS.3d_igs.zip](#)

English

Customer View Model

[ENG_CVM_3-61668-1_AS.3d_stp.zip](#)

English

Customer View Model

[ENG_CVM_3-61668-1_AS.2d_dxf.zip](#)

English

[3D PDF](#)

English

By downloading the CAD file I accept and agree to the [Terms and Conditions](#) of use.

Product Specifications



Bifurcated Leaf Contact

English

Application Specification

English

Application Specification

English

Relay Receptacle Contact

English