

---

## LOW NOISE 300mA LDO REGULATOR

---

NO.EA-141-160705

### OUTLINE

The RP102x Series are CMOS-based voltage regulator ICs with high output voltage accuracy, extremely low supply current, low ON-resistance, and high ripple rejection. Each of these ICs consists of a voltage reference unit, an error amplifier, a resistor-net for voltage setting, a current limit circuit and a chip enable circuit.

These ICs perform with low dropout voltage and "chip enable" function. The line transient response and load transient response of the RP102x Series are excellent, thus these ICs are very suitable for the power supply for hand-held communication equipment.

The output voltage of these ICs is fixed with high accuracy. Since the packages for these ICs are SOT-23-5, DFN(PLP)1820-6, and WLCSP-4-P2, therefore high density mounting of the ICs on boards is possible.

### FEATURES

- Supply Current ..... Typ. 50 $\mu$ A
- Standby Mode ..... Typ. 0.1 $\mu$ A
- Dropout Voltage ..... Typ. 0.12V ( $I_{OUT}=300\text{mA}$ ,  $V_{OUT}=2.8\text{V}$ )
- Ripple Rejection ..... Typ. 80dB ( $f=1\text{kHz}$ )
- Temperature-Drift Coefficient of Output Voltage ... Typ.  $\pm 20\text{ppm}/^\circ\text{C}$
- Line Regulation ..... Typ. 0.02%/V
- Output Voltage Accuracy .....  $\pm 0.8\%$
- Packages ..... WLCSP-4-P2, DFN(PLP)1820-6, SOT-23-5
- Input Voltage Range ..... 1.7V to 5.25V
- Output Voltage Range ..... 1.2V to 3.3V (0.1V steps)  
(For other voltages, please refer to MARK INFORMATION.)
- Built-in Fold Back Protection Circuit ..... Typ. 50mA (Current at short mode)
- Ceramic capacitors are recommended to be used with this IC .....  $C_{IN}=C_{OUT}=1\mu\text{F}$  or more

### APPLICATIONS

- Power source for portable communication equipment.
- Power source for electrical appliances such as cameras, VCRs and camcorders.
- Power source for battery-powered equipment.

## RP102x

NO.EA-141-160705

## BLOCK DIAGRAMS

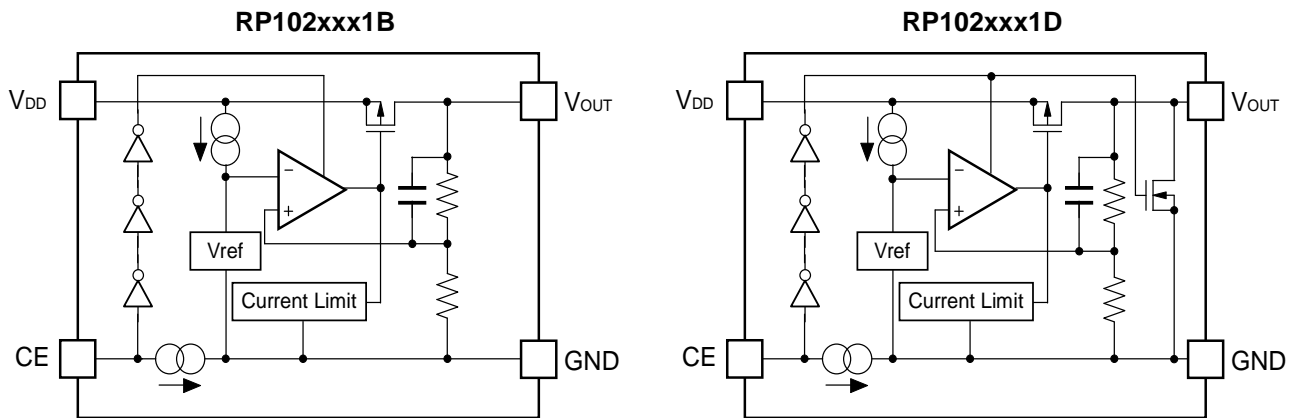

## SELECTION GUIDE

The output voltage, auto discharge function, package, and the taping type, etc. for the ICs can be selected at the user's request.

Product Name	Package	Quantity per Reel	Pb Free	Halogen Free
RP102Zxx1*-TR-F	WLCSP-4-P2	5,000 pcs	Yes	Yes
RP102Kxx1*-TR	DFN(PLP)1820-6	5,000 pcs	Yes	Yes
RP102Nxx1*-TR-FE	SOT-23-5	3,000 pcs	Yes	Yes

xx: The output voltage can be designated in the range from 1.2V(12) to 3.3V(33) in 0.1V steps.  
(For other voltages, please refer to MARK INFORMATIONS.)

\* : CE pin polarity and auto discharge function at off state are options as follows.  
(B) "H" active, without auto discharge function at off state  
(D) "H" active, with auto discharge function at off state

## PIN CONFIGURATIONS

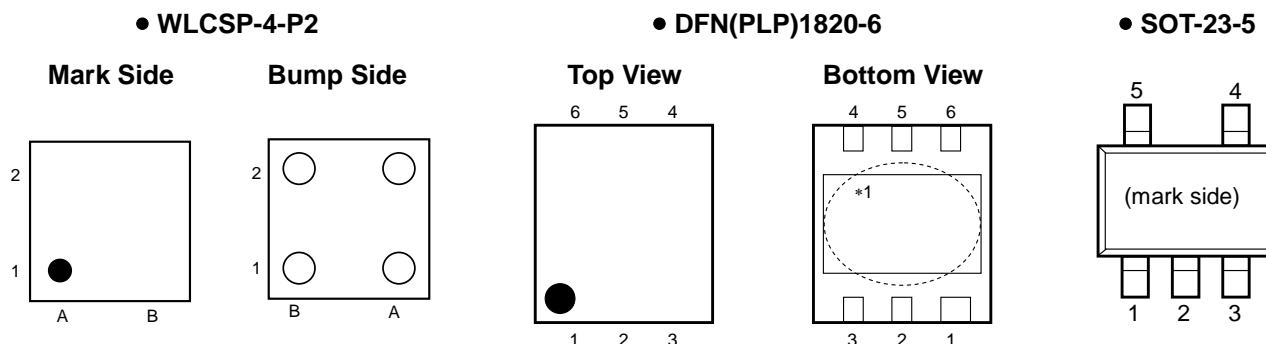

## PIN DESCRIPTION

### • WLCSP-4-P2

Pin No	Symbol	Pin Description
A1	V <sub>DD</sub>	Input Pin
A2	V <sub>OUT</sub>	Output Pin
B1	CE	Chip Enable Pin ("H" Active)
B2	GND	Ground Pin

### • DFN(PLP)1820-6

Pin No	Symbol	Pin Description
1	V <sub>OUT</sub>	Output Pin*2
2	V <sub>OUT</sub>	Output Pin*2
3	GND	Ground Pin
4	CE	Chip Enable Pin ("H" Active)
5	V <sub>DD</sub>	Input Pin*2
6	V <sub>DD</sub>	Input Pin*2

\*1) Tab is GND level. (They are connected to the reverse side of this IC.)

The tab is better to be connected to the GND, but leaving it open is also acceptable.

\*2) No.1 pin and No.2 pin, No.5 pin and No.6 pin of DFN(PLP)1820-6 package must be wired when it is mounted on board.

### • SOT-23-5

Pin No	Symbol	Pin Description
1	V <sub>DD</sub>	Input Pin
2	GND	Ground Pin
3	CE	Chip Enable Pin ("H" Active)
4	NC	No Connection
5	V <sub>OUT</sub>	Output Pin

## ABSOLUTE MAXIMUM RATINGS

Symbol	Item	Rating	Unit
V <sub>IN</sub>	Input Voltage	6.0	V
V <sub>CE</sub>	Input Voltage (CE Pin)	6.0	V
V <sub>OUT</sub>	Output Voltage	-0.3 to V <sub>IN</sub> +0.3	V
I <sub>OUT</sub>	Output Current	400	mA
P <sub>D</sub>	Power Dissipation (WLCSP-4-P2) *	530	mW
	Power Dissipation (SOT-23-5) *	420	
	Power Dissipation (DFN(PLP)1820-6) *	880	
T <sub>opt</sub>	Operating Temperature Range	-40 to 85	°C
T <sub>stg</sub>	Storage Temperature Range	-55 to 125	°C

\*) For Power Dissipation, please refer to PACKAGE INFORMATION.

### ABSOLUTE MAXIMUM RATINGS

Electronic and mechanical stress momentarily exceeded absolute maximum ratings may cause the permanent damages and may degrade the life time and safety for both device and system using the device in the field.

The functional operation at or over these absolute maximum ratings is not assured.

### RECOMMENDED OPERATING CONDITIONS (ELECTRICAL CHARACTERISTICS)

All of electronic equipment should be designed that the mounted semiconductor devices operate within the recommended operating conditions. The semiconductor devices cannot operate normally over the recommended operating conditions, even if when they are used over such conditions by momentary electronic noise or surge.

And the semiconductor devices may receive serious damage when they continue to operate over the recommended operating conditions.

## ELECTRICAL CHARACTERISTICS

### • RP102xxx1B/D

$V_{IN}$ =Set  $V_{OUT}+1V$  for  $V_{OUT}$  options grater than 1.5V.  $V_{IN}=2.5V$  for  $V_{OUT} \leq 1.5V$ .

$I_{OUT}=1mA$ ,  $C_{IN}=C_{OUT}=1\mu F$ , unless otherwise noted.

$T_{opt}=25^{\circ}C$

Symbol	Item	Conditions	Min.	Typ.	Max.	Unit
$V_{OUT}$	Output Voltage	$V_{IN}=\text{Set } V_{OUT}+1V$	$V_{OUT} > 2.0V$	$\times 0.992$	$\times 1.008$	V
			$V_{OUT} \leq 2.0V$	-16	+16	mV
$I_{OUT}$	Output Current		300			mA
$\frac{\Delta V_{OUT}}{\Delta I_{OUT}}$	Load Regulation	$1mA \leq I_{OUT} \leq 150mA$		10	20	mV
		$1mA \leq I_{OUT} \leq 300mA$		20	40	
$V_{DIF}$	Dropout Voltage	Refer to the following table				
$I_{SS}$	Supply Current	$I_{OUT}=0mA$		50	70	$\mu A$
$I_{standby}$	Supply Current (Standby)	$V_{CE}=0V$		0.1	2.0	$\mu A$
$\Delta V_{OUT}/\Delta V_{IN}$	Line Regulation	Set $V_{OUT}+0.5V \leq V_{IN} \leq 5V$		0.02	0.10	%/V
RR	Ripple Rejection	$f=1kHz$ , Ripple 0.2Vp-p $V_{IN}=\text{Set } V_{OUT}+1V$ , $I_{OUT}=30mA$ (In case that $V_{OUT} \leq 2V$ , $V_{IN}=3V$ )		80		dB
$V_{IN}$	Input Voltage*		1.7		5.25	V
$\Delta V_{OUT}/\Delta T_{opt}$	Output Voltage Temperature Coefficient	$-40^{\circ}C \leq T_{opt} \leq 85^{\circ}C$		$\pm 20$		ppm/ $^{\circ}C$
$I_{SC}$	Short Current Limit	$V_{OUT}=0V$		50		mA
$I_{PD}$	CE Pull-down Current		0.05	0.3	0.6	$\mu A$
$V_{CEH}$	CE Input Voltage "H"		1.1			V
$V_{CEL}$	CE Input Voltage "L"				0.3	V
en	Output Noise	$BW=10Hz$ to $100kHz$ , $I_{OUT}=30mA$		30		$\mu V_{rms}$
$R_{LOW}$	Low Output Nch Tr. ON Resistance (of D version)	$V_{IN}=4V$ $V_{CE}=0V$		30		$\Omega$

\*) The maximum Input Voltage of the ELECTRICAL CHARACTERISTICS is 5.25V. In case of exceeding this specification, the IC must be operated on condition that the Input Voltage is up to 5.5V and the total operating time is within 500hrs.

### • Electrical Characteristics by Output Voltage

$T_{opt}=25^{\circ}C$

Output Voltage $V_{OUT}$ (V)	Dropout Voltage $V_{DIF}$ (V)					
	Condition	Typ.	Max.	Condition	Typ.	Max.
$1.2V \leq V_{OUT} < 1.5V$	$I_{OUT}=150mA$	0.145	-	$I_{OUT}=300mA$	0.290	0.500
$1.5V \leq V_{OUT} < 1.7V$		0.110	0.160		0.220	0.320
$1.7V \leq V_{OUT} < 2.0V$		0.100	0.140		0.200	0.280
$2.0V \leq V_{OUT} < 2.5V$		0.085	0.120		0.170	0.240
$2.5V \leq V_{OUT} < 2.8V$		0.070	0.100		0.140	0.200
$2.8V \leq V_{OUT} \leq 3.3V$		0.060	0.095		0.120	0.190

## TYPICAL APPLICATION

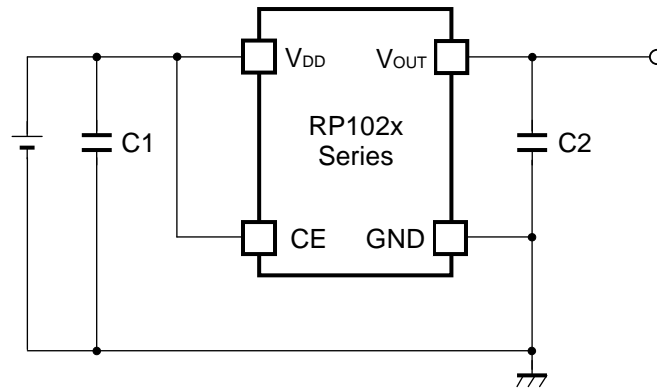

(External Components)

C2 1.0 $\mu$ F MURATA: GRM155B31A105KE15

## TECHNICAL NOTES

When using these ICs, consider the following points:

### Phase Compensation

In these ICs, phase compensation is made for securing stable operation even if the load current is varied. For this purpose, use a capacitor C2 with good frequency characteristics and ESR (Equivalent Series Resistance). (Note: If additional ceramic capacitors are connected with parallel to the output pin with an output capacitor for phase compensation, the operation might be unstable. Because of this, test these ICs with as same external components as ones to be used on the PCB.)

### PCB Layout

Make V<sub>DD</sub> and GND lines sufficient. If their impedance is high, noise pickup or unstable operation may result. Connect a capacitor C1 with a capacitance value as much as 1.0 $\mu$ F or more between V<sub>DD</sub> and GND pin, and as close as possible to the pins.

Set external components, especially the output capacitor C2, as close as possible to the ICs, and make wiring as short as possible.

TEST CIRCUITS

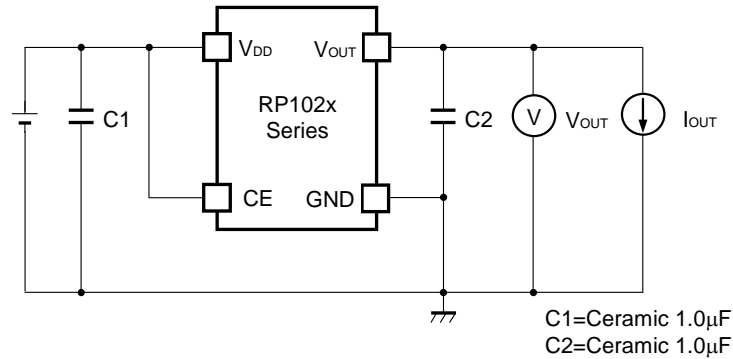

Basic Test Circuit

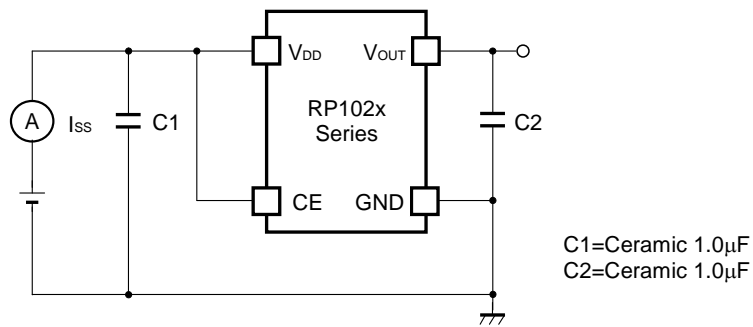

Test Circuit for Supply Current

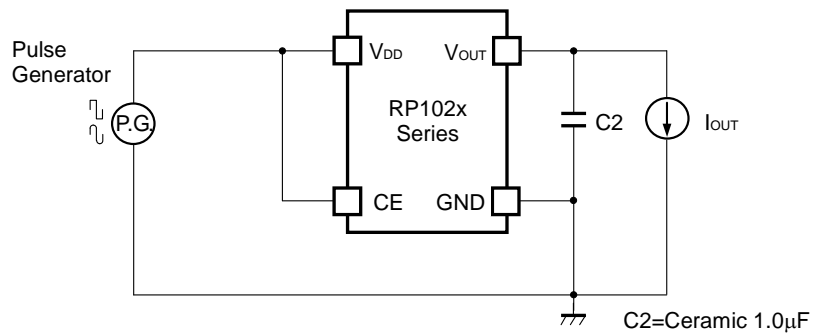

Test Circuit for Ripple Rejection

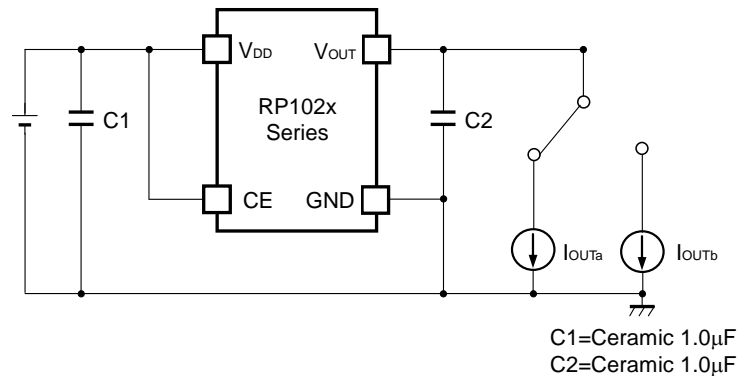

Test Circuit for Load Transient Response

# RP102x

NO.EA-141-160705

## TYPICAL CHARACTERISTIC

### 1) Output Voltage vs. Output Current ( $C_{IN}=1.0\mu F$ , $C_{OUT}=1.0\mu F$ , $T_{opt}=25^{\circ}C$ )

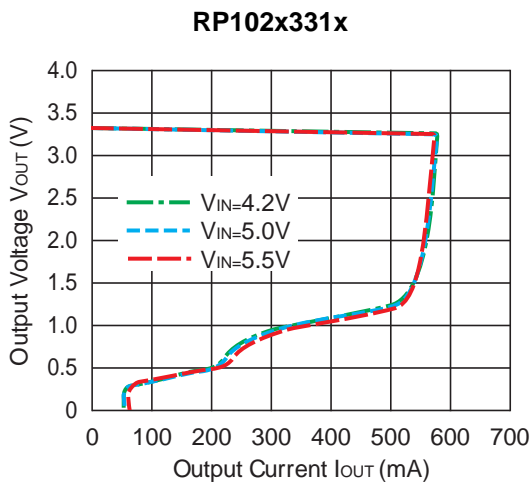
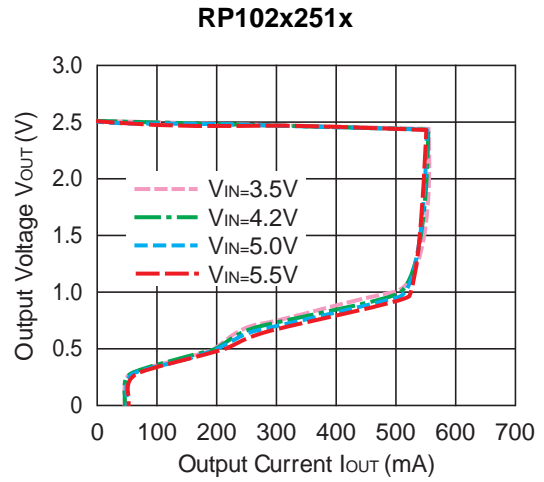
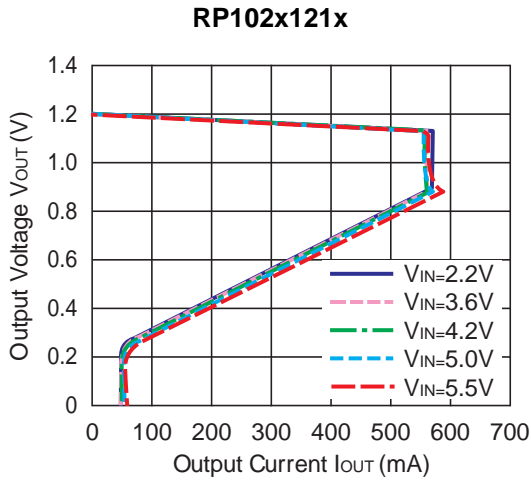

### 2) Output Voltage vs. Input Voltage ( $C_{IN}=1.0\mu F$ , $C_{OUT}=1.0\mu F$ , $T_{opt}=25^{\circ}C$ )

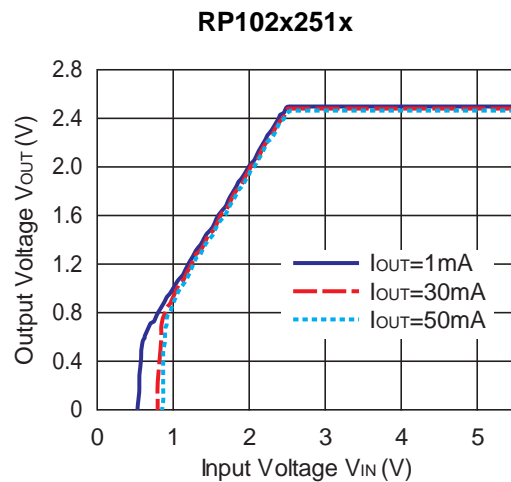
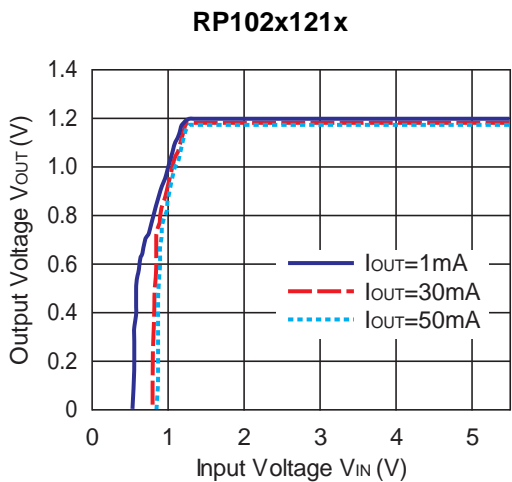



RP102x331x

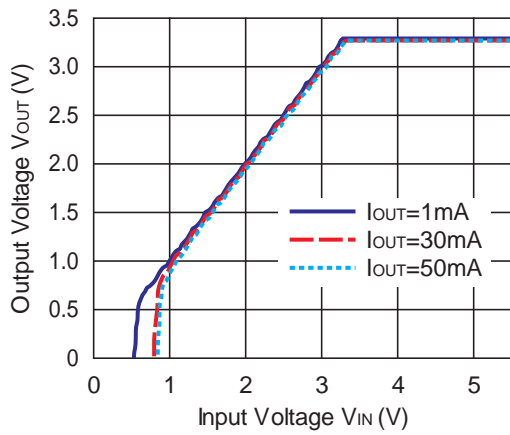

3) Supply Current vs. Input Voltage ( $C_{IN}=1.0\mu F$ ,  $C_{OUT}=1.0\mu F$ ,  $T_{opt}=25^{\circ}C$ )

RP102x121x

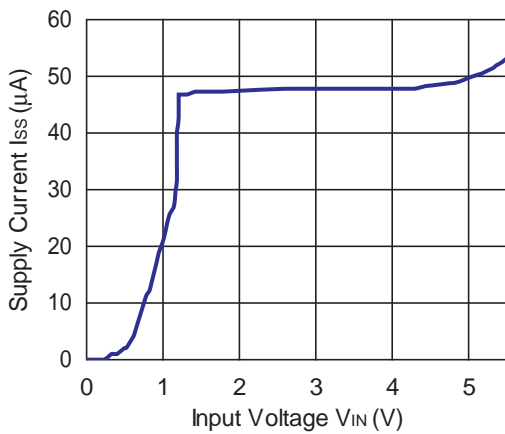

RP102x251x

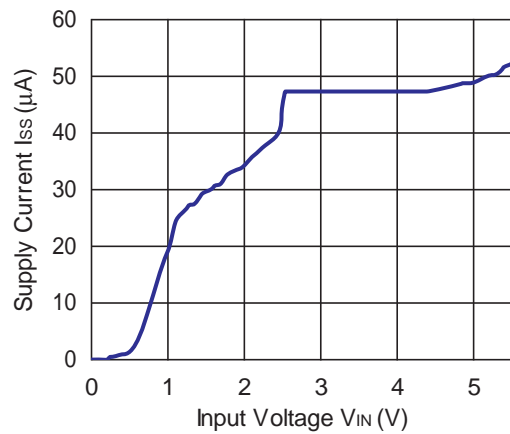

RP102x331x

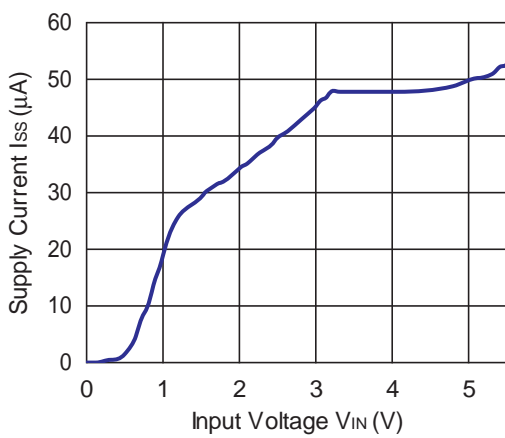

---

## RP102x

---

NO.EA-141-160705

### 4) Output Voltage vs. Temperature ( $C_{IN}=1.0\mu F$ , $C_{OUT}=1.0\mu F$ , $I_{OUT}=1mA$ )

RP102x121x

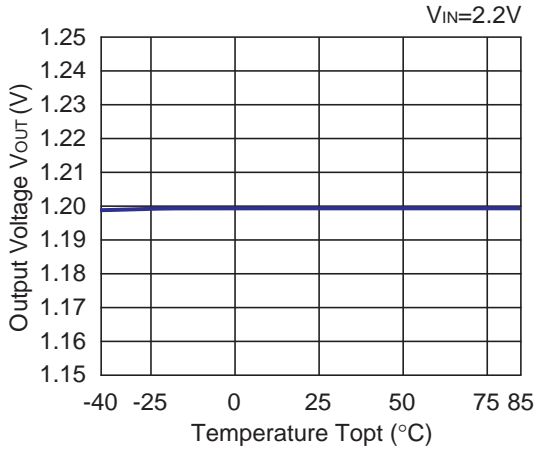

RP102x251x

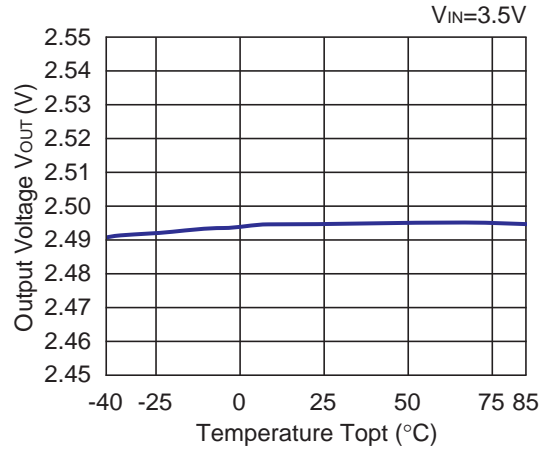

RP102x331x

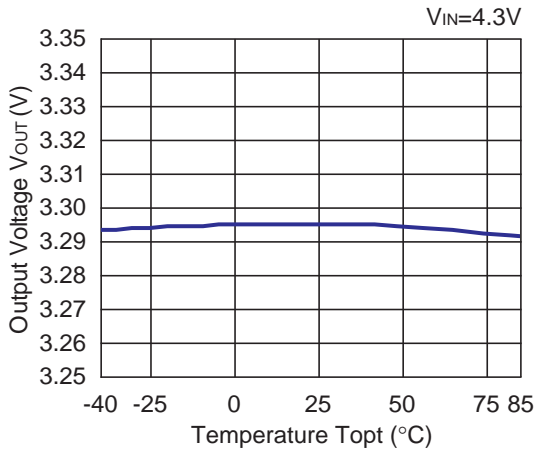

### 5) Supply Current vs. Temperature ( $C_{IN}=1.0\mu F$ , $C_{OUT}=1.0\mu F$ , $I_{OUT}=0mA$ )

RP102x121x

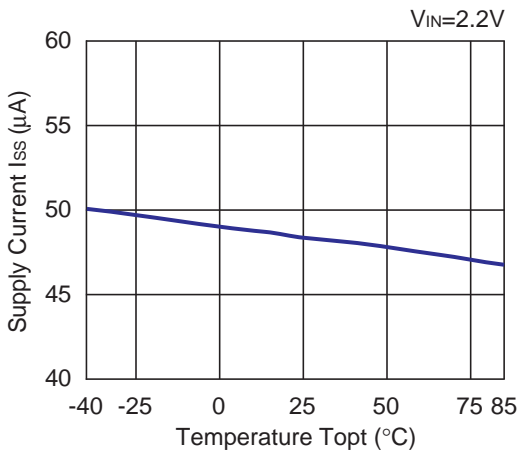

RP102x251x

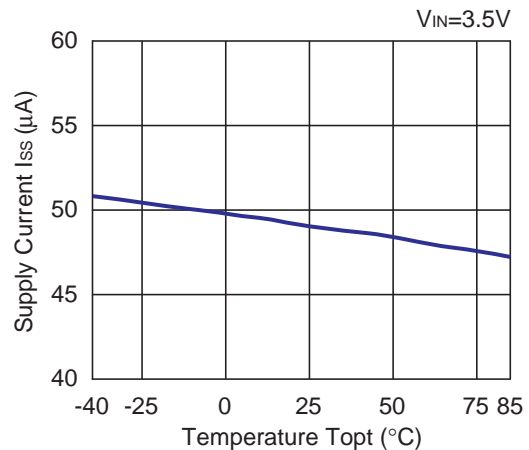

RP102x331x

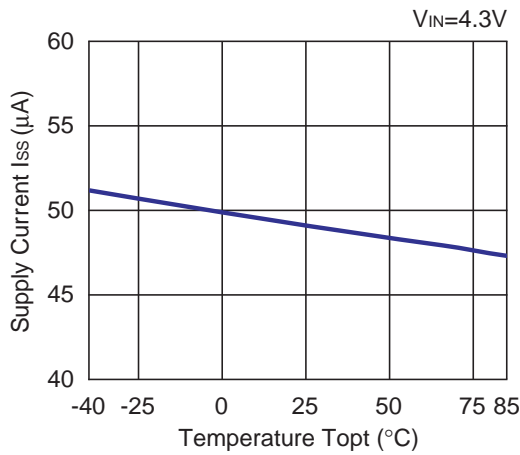

6) Dropout Voltage vs. Output Current ( $C_{IN}=1.0\mu F$ ,  $C_{OUT}=1.0\mu F$ )

RP102x121x

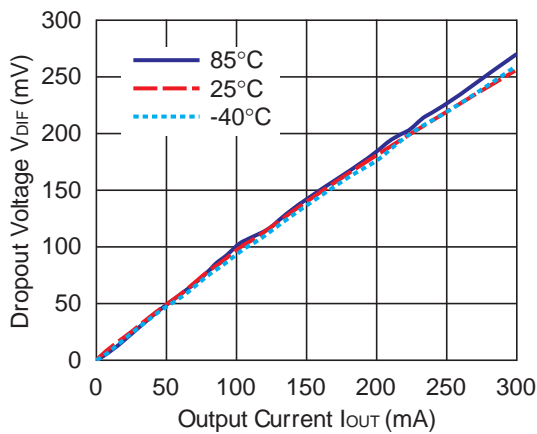

RP102x251x

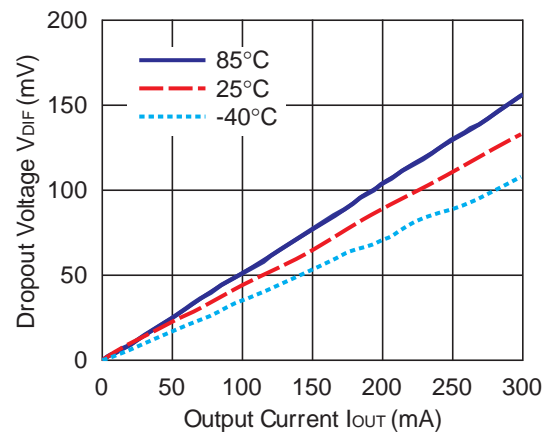

RP102x331x

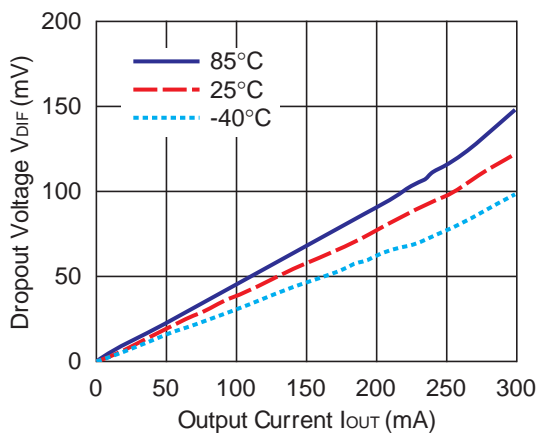

# RP102x

NO.EA-141-160705

## 7) Dropout Voltage vs Set Output Voltage ( $C_{IN}=1.0\mu F$ , $C_{OUT}=1.0\mu F$ , $T_{opt}=25^\circ C$ )

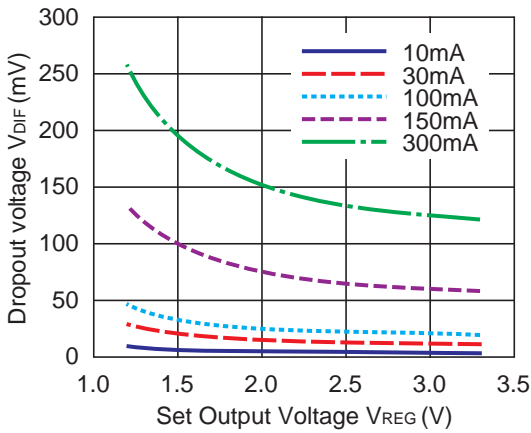

## 8) Ripple Rejection vs. Input Bias Voltage ( $C_{IN}=none$ , $C_{OUT}=1.0\mu F$ , $Ripple=0.2Vp-p$ , $T_{opt}=25^\circ C$ )

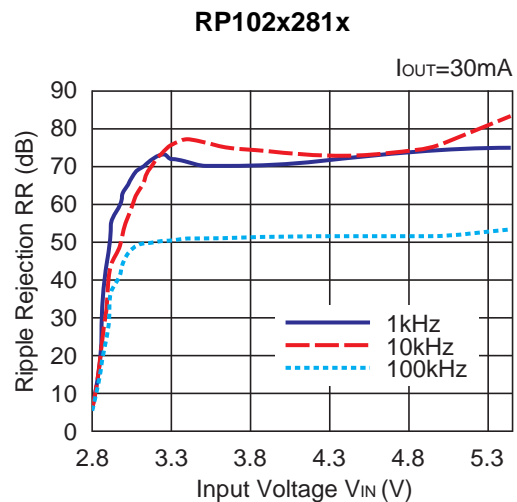
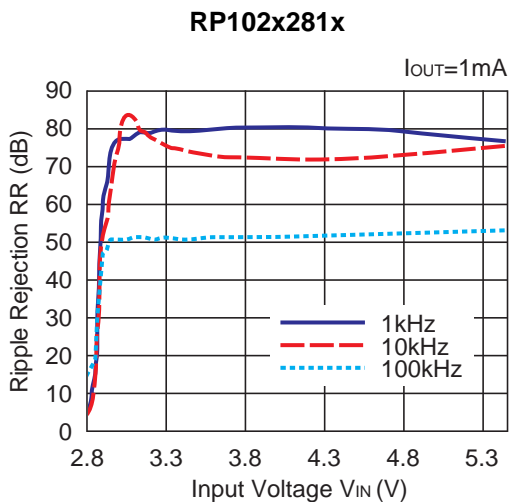
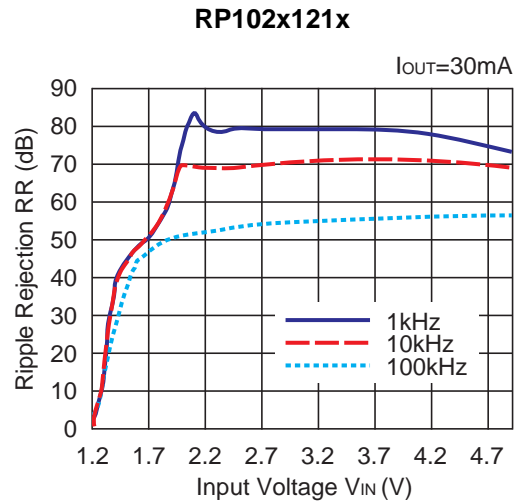
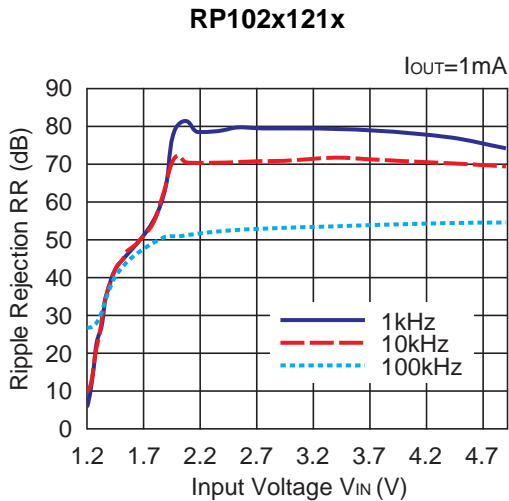

9) Ripple Rejection vs. Frequency ( $C_{IN}=1.0\mu F$ ,  $C_{OUT}=1.0\mu F$ , Ripple=0.2Vp-p)

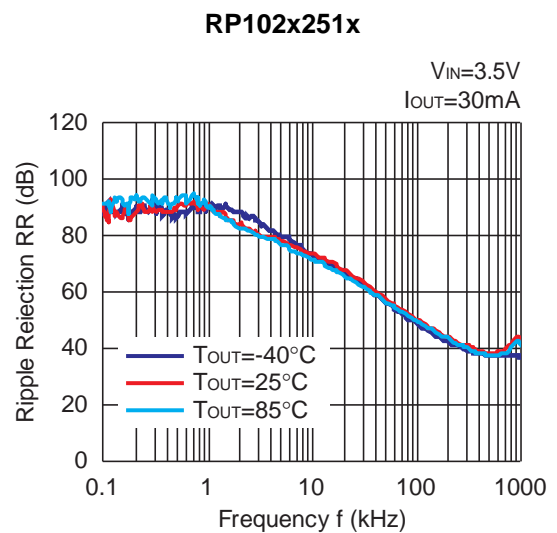
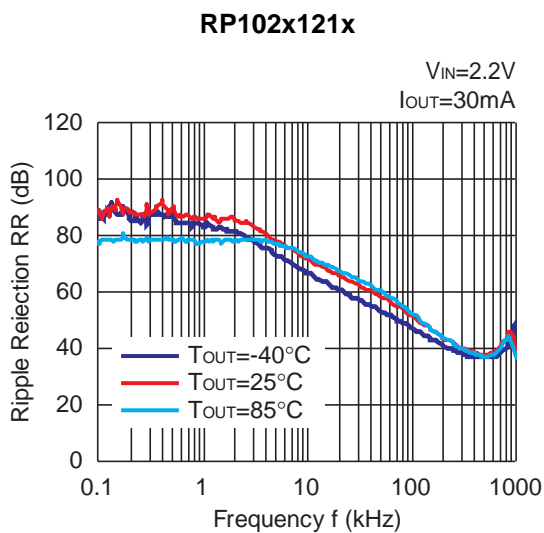
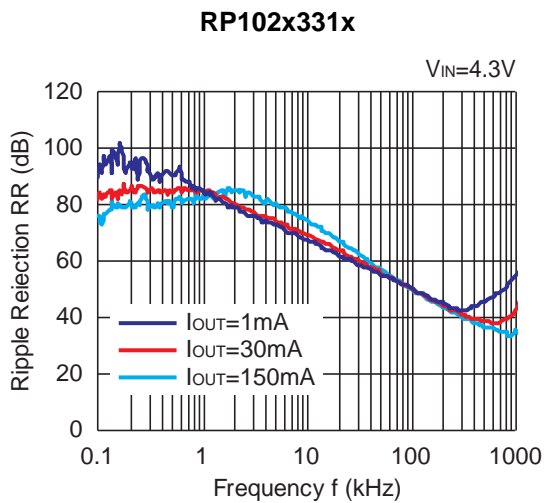
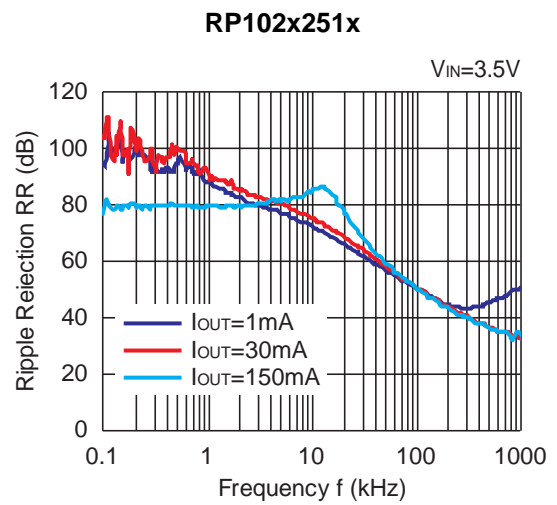
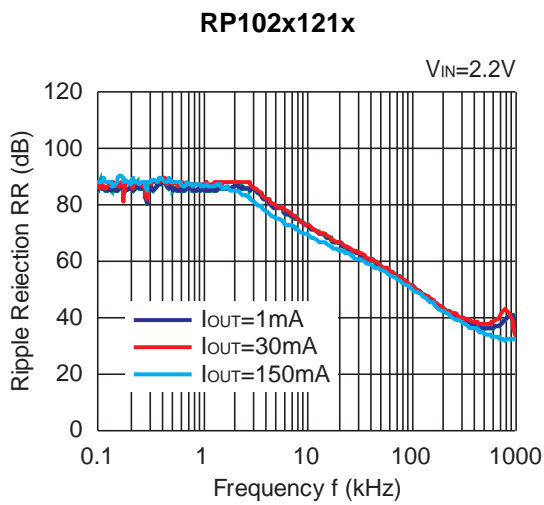

# RP102x

NO.EA-141-160705

## RP102x331x

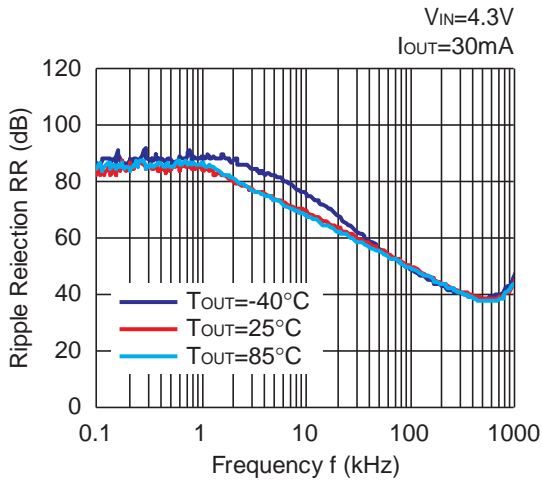

### 10) Input Transient Response ( $C_{IN}=\text{none}$ , $C_{OUT}=1.0\mu F$ , $I_{OUT}=30mA$ , $t_r=t_f=5\mu s$ , $T_{opt}=25^{\circ}C$ )

#### RP102x121x

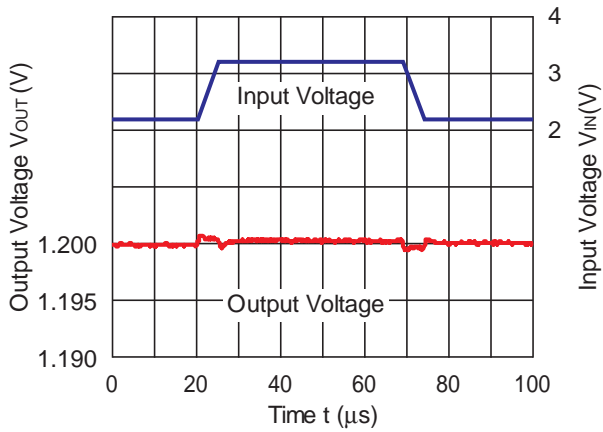

#### RP102x251x

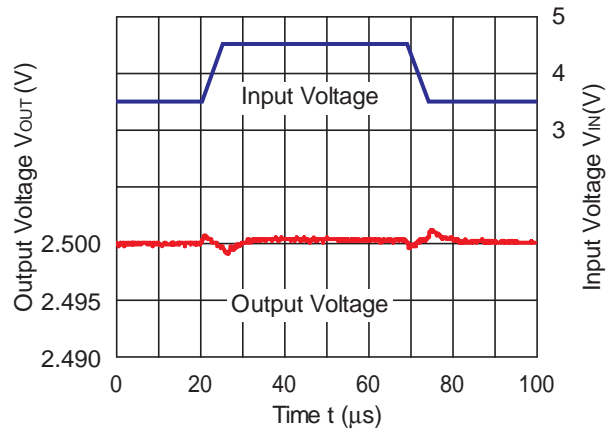

#### RP102x331x

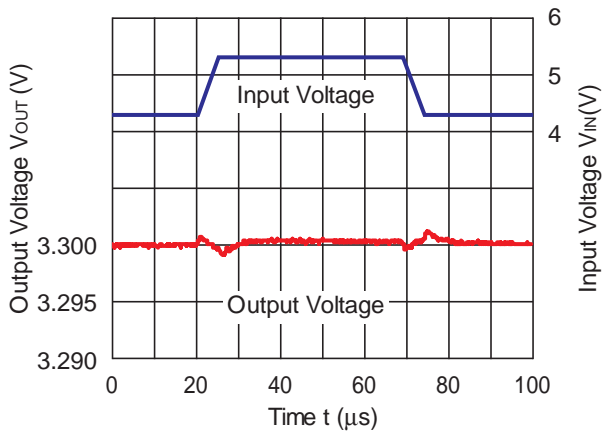

11) Load Transient Response ( $C_{OUT}=1.0\mu F$ ,  $T_{opt}=25^{\circ}C$ )

RP102x121x

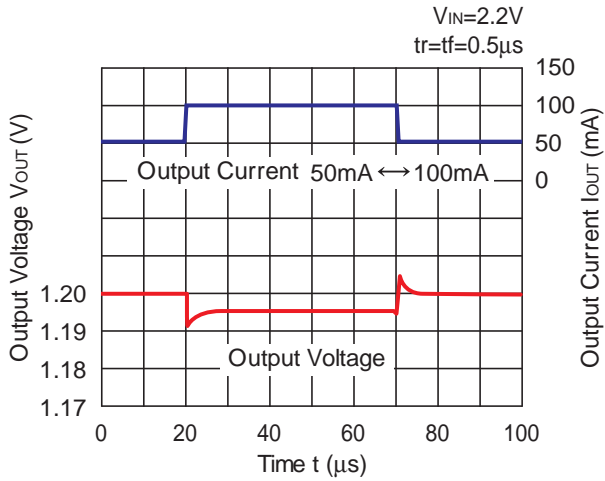

RP102x251x

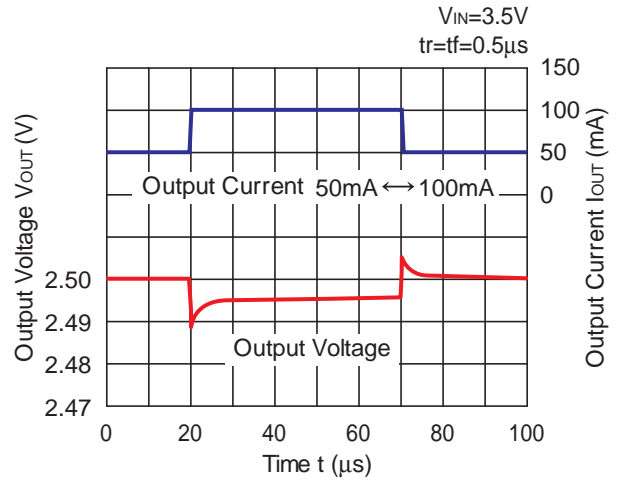

RP102x331x

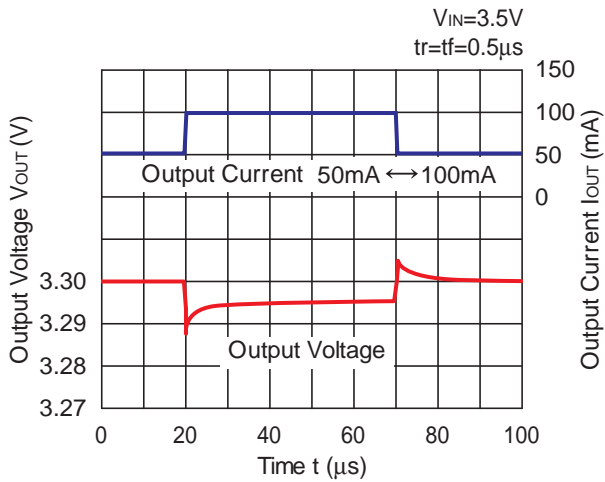

RP102x121x

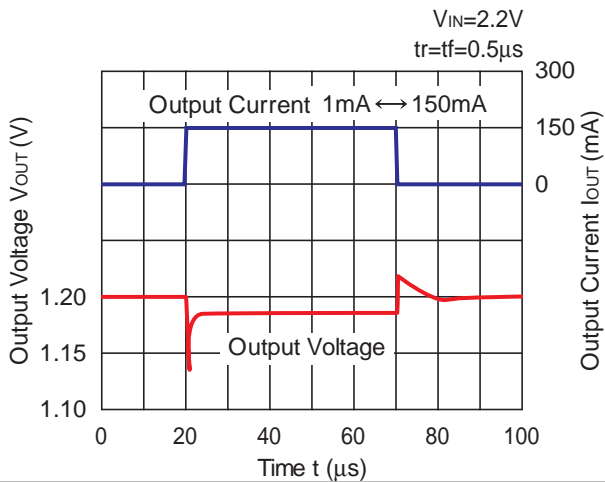

RP102x251x

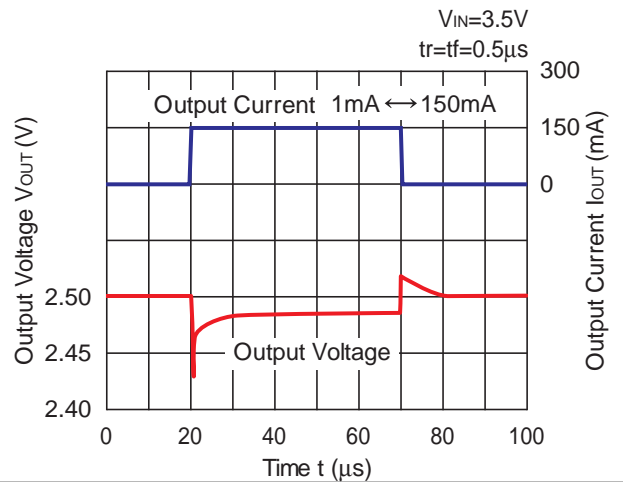

# RP102x

NO.EA-141-160705

## RP102x331x

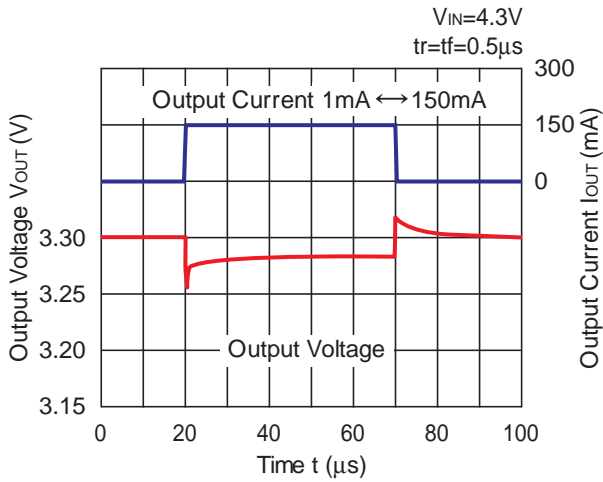

## 12) Turn On Speed with CE pin ( $C_{IN}=1.0\mu F$ , $C_{OUT}=1.0\mu F$ , $T_{opt}=25^\circ C$ )

### RP102x121x

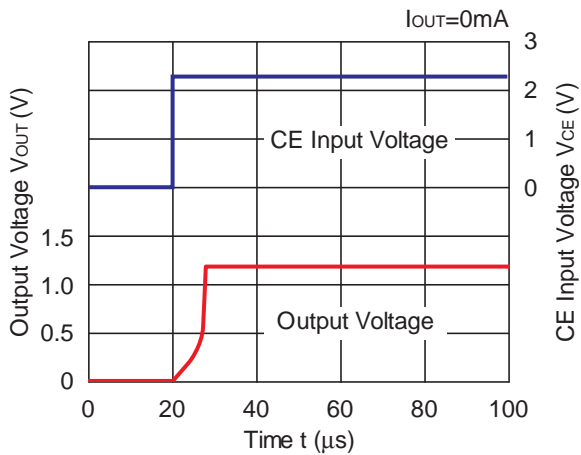

### RP102x121x

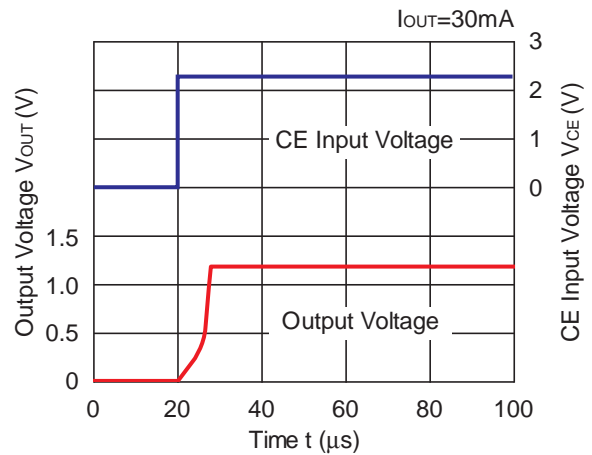

### RP102x121x

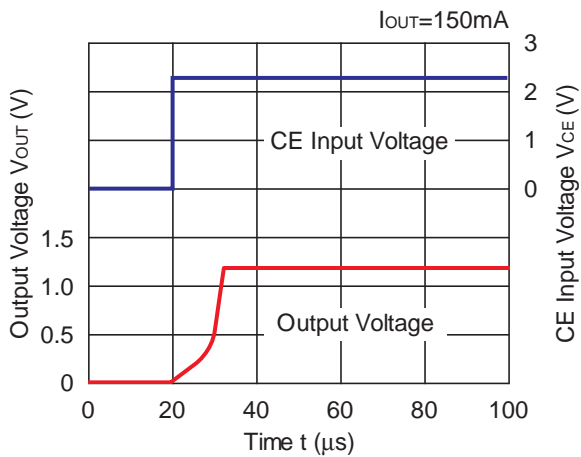



RP102x251x

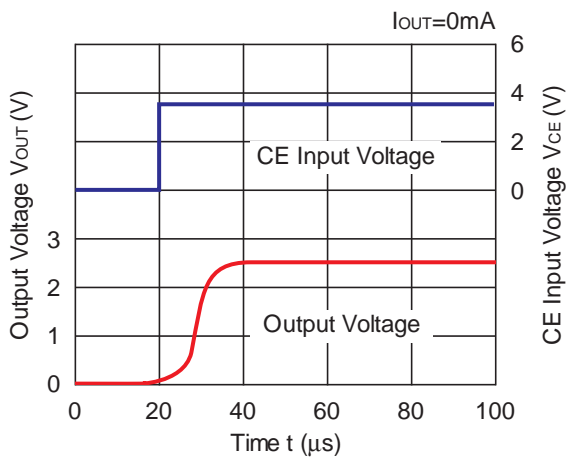

RP102x251x

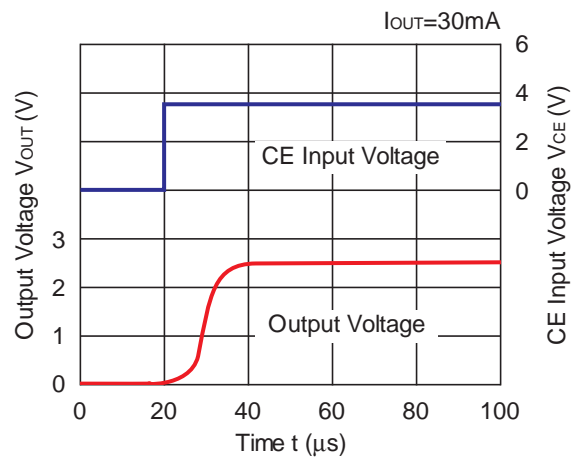

RP102x251x

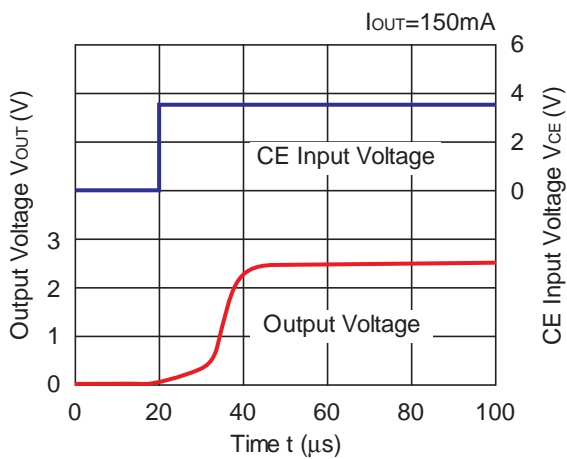

RP102x331x

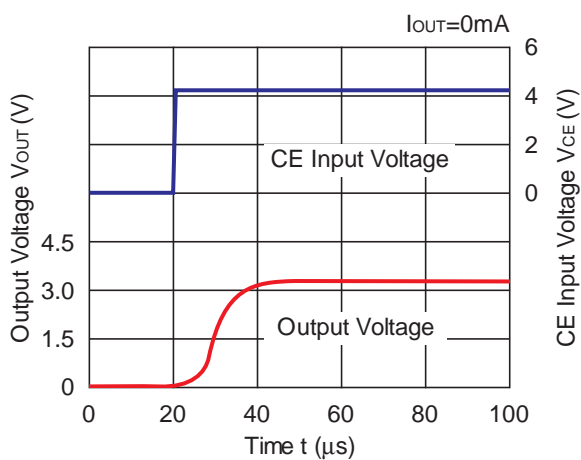

RP102x331x

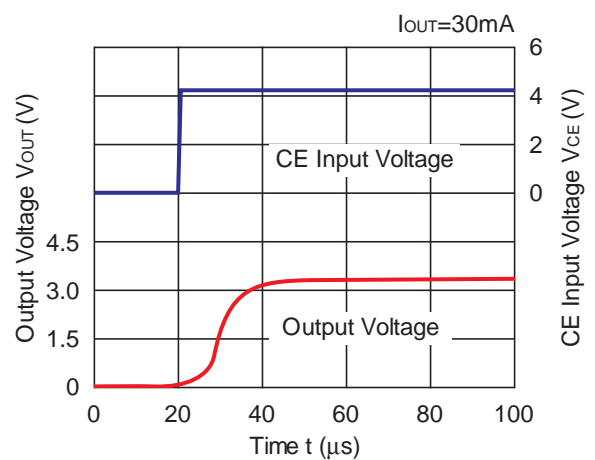

# RP102x

NO.EA-141-160705

## RP102x331x

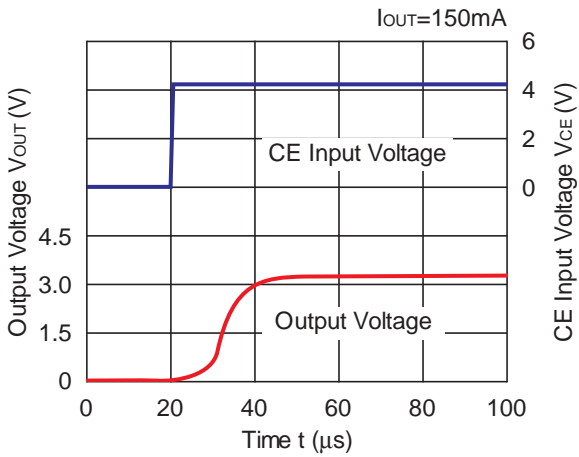

### 13) Turn OFF Speed with CE pin (D Version) ( $C_{IN}=1.0\mu F$ , $C_{OUT}=1.0\mu F$ , $T_{opt}=25^{\circ}C$ )

#### RP102x121D

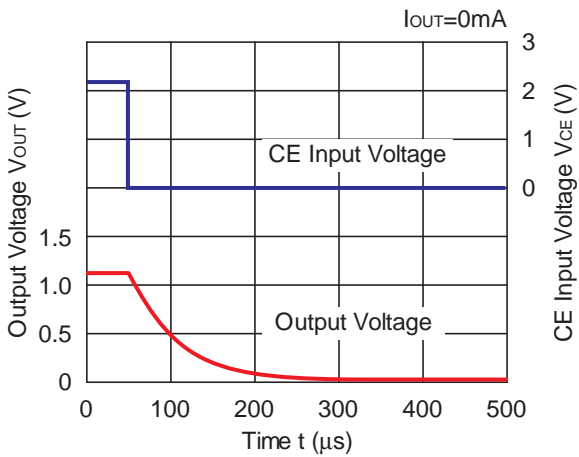

#### RP102x121D

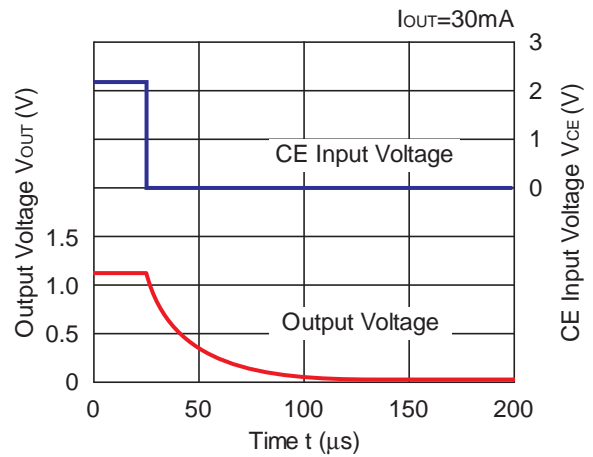

#### RP102x121D

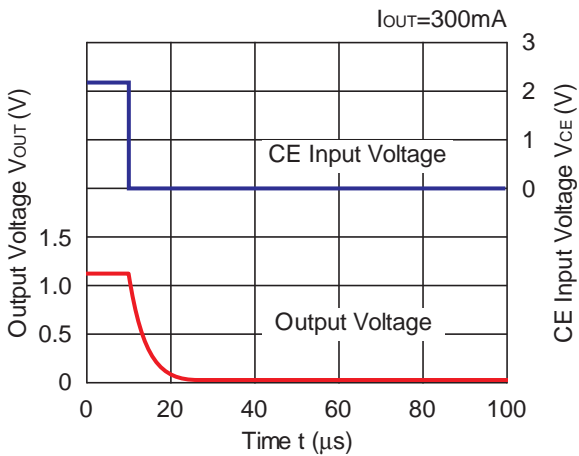

RP102x251x

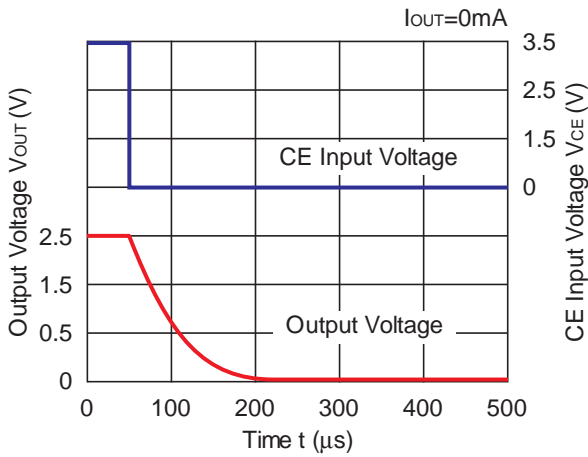

RP102x251x

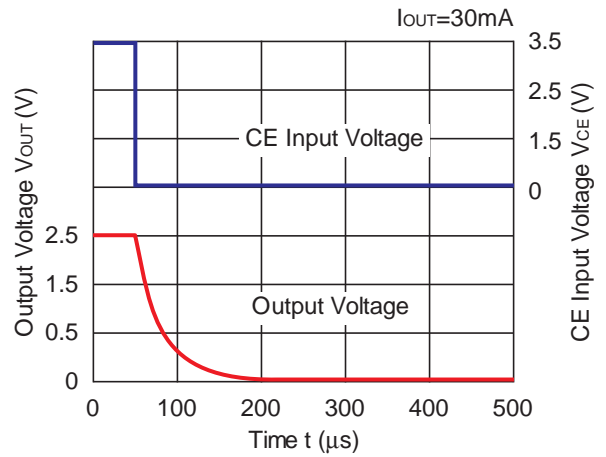

RP102x251x

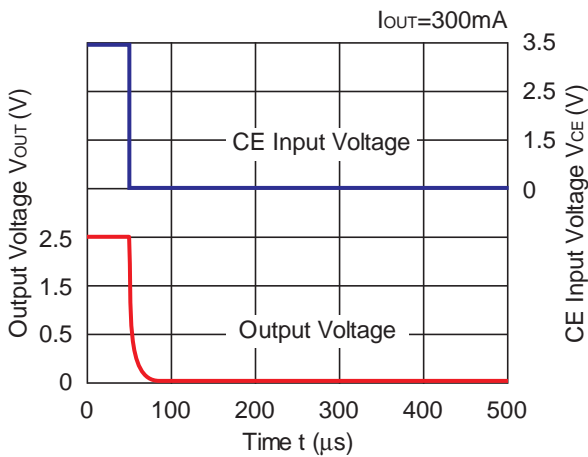

RP102x331x

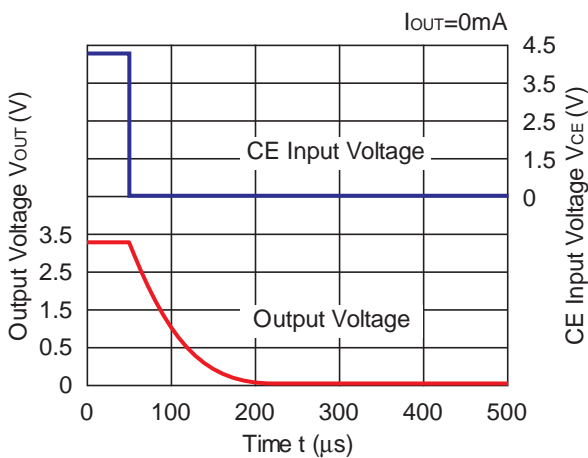

RP102x331x

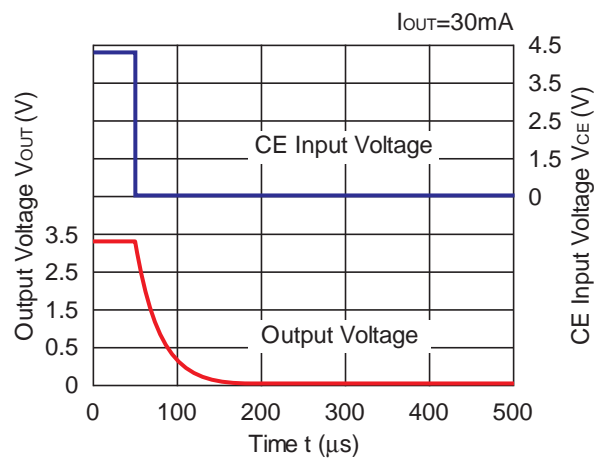

---

**RP102x**

---

NO.EA-141-160705

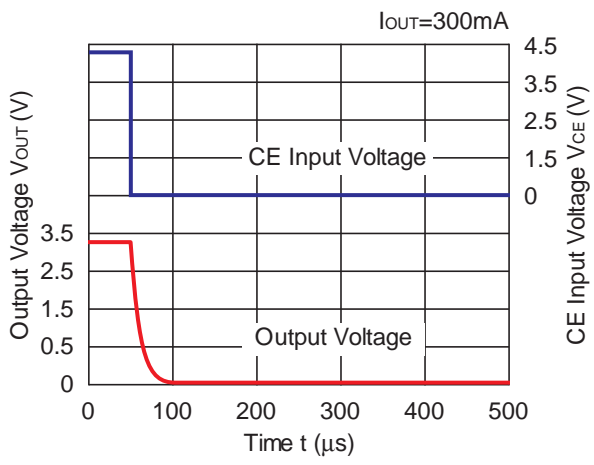
**RP102x331x**

## ESR vs. Output Current

When using these ICs, consider the following points:

The relations between  $I_{OUT}$  (Output Current) and ESR of an output capacitor are shown below.

The conditions when the white noise level is under  $40\mu V$  (Avg.) are marked as the hatched area in the graph.

### Measurement conditions

Frequency Band: 10Hz to 2MHz

Temperature:  $-40^{\circ}C$  to  $85^{\circ}C$

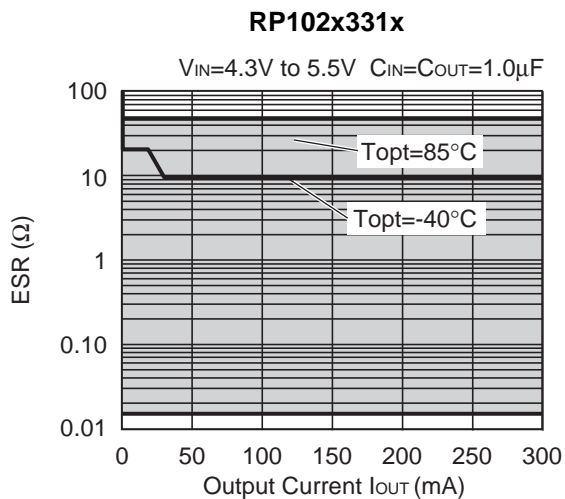
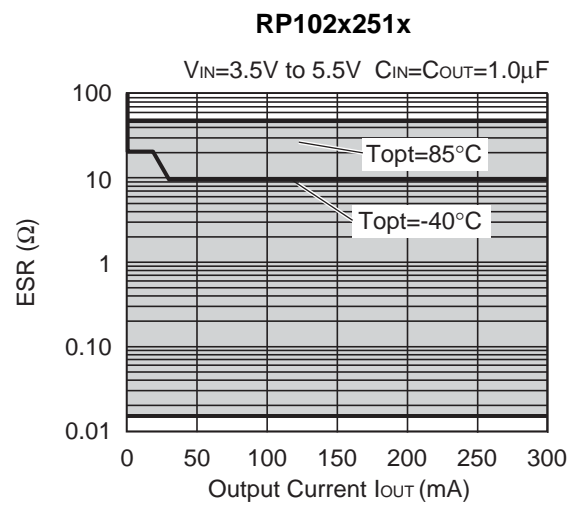
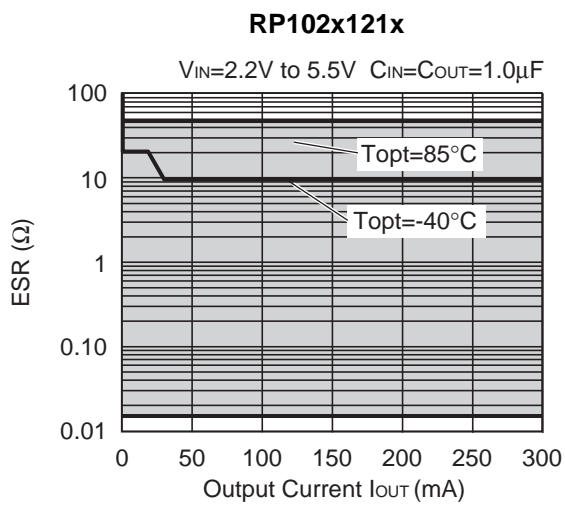

## PACKAGE INFORMATION

### Power Dissipation (WLCSP-4-P2)

This specification is at mounted on board. Power Dissipation ( $P_D$ ) depends on conditions of mounting on board. This specification is based on the measurement at the condition below:

#### Measurement Conditions

	Standard Land Pattern
Environment	Mounting on Board (Wind velocity=0m/s)
Board Material	Glass cloth epoxy plastic (Double-sided)
Board Dimensions	40mm x 40mm x 1.6mm
Copper Ratio	Top side: Approx. 50%, Back side: Approx. 50%
Through-hole	$\phi 0.5\text{mm} \times 4\text{pcs}$

#### Measurement Result

( $T_a=25^\circ\text{C}$ )

	Standard Land Pattern
Power Dissipation	530mW ( $T_{j\text{max}}=125^\circ\text{C}$ ) 662mW ( $T_{j\text{max}}=150^\circ\text{C}$ )
Thermal Resistance	$\theta_{ja}=(125-25^\circ\text{C})/0.53\text{W}=189^\circ\text{C/W}$

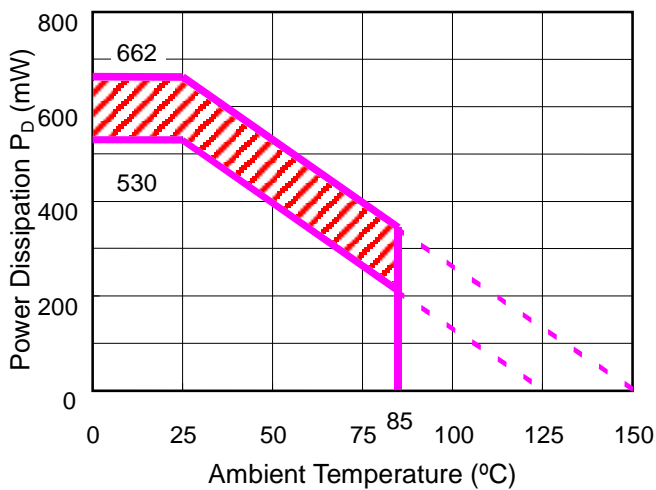

**Power Dissipation**

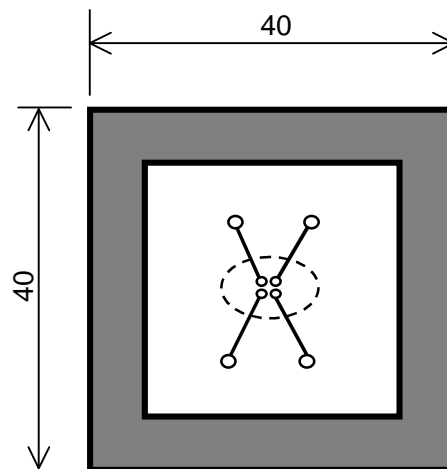

**Measurement Board Pattern**

IC Mount Area (Unit: mm)

The above graph shows the Power Dissipation of the package based on  $T_{j\text{max}}=125^\circ\text{C}$  and  $T_{j\text{max}}=150^\circ\text{C}$ . Operating the IC in the shaded area in the graph might have an influence on its lifetime. Operating time must be within the time limit described in the table below, in case of operating in the shaded area.

Operating Time	Estimated years (Operating 4 hours/day)
13,000 hours	9years

Package Dimensions (WLCSP-4-P2)

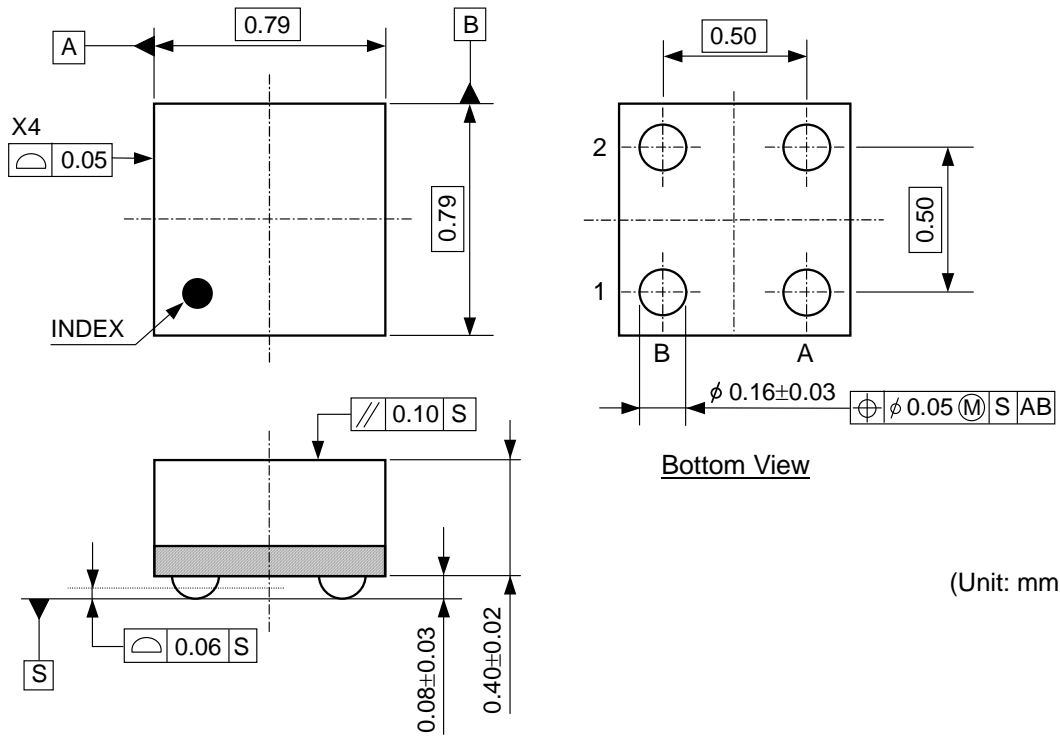

(Unit: mm)

Mark Specifications (WLCSP-4-P2)

①②: Lot Number ... Alphanumeric Serial Number

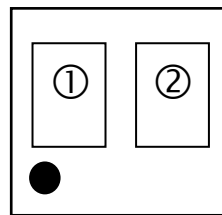

# RP102x

NO.EA-141-160705

## Power Dissipation (DFN(PLP)1820-6)

This specification is at mounted on board. Power Dissipation ( $P_D$ ) depends on conditions of mounting on board. This specification is based on the measurement at the condition below:

### Measurement Conditions

	Standard Land Pattern
Environment	Mounting on Board (Wind velocity=0m/s)
Board Material	Glass cloth epoxy plastic (Double-sided)
Board Dimensions	40mm x 40mm x 1.6mm
Copper Ratio	Top side: Approx. 50%, Back side: Approx. 50%
Through-hole	$\phi 0.54\text{mm} \times 30\text{pcs}$

### Measurement Result

( $T_a=25^\circ\text{C}$ )

	Standard Land Pattern
Power Dissipation	880mW( $T_{j\text{max}}=125^\circ\text{C}$ ) 1100mW( $T_{j\text{max}}=150^\circ\text{C}$ )
Thermal Resistance	$\theta_{ja}=(125-25^\circ\text{C})/0.88\text{W}=114^\circ\text{C/W}$

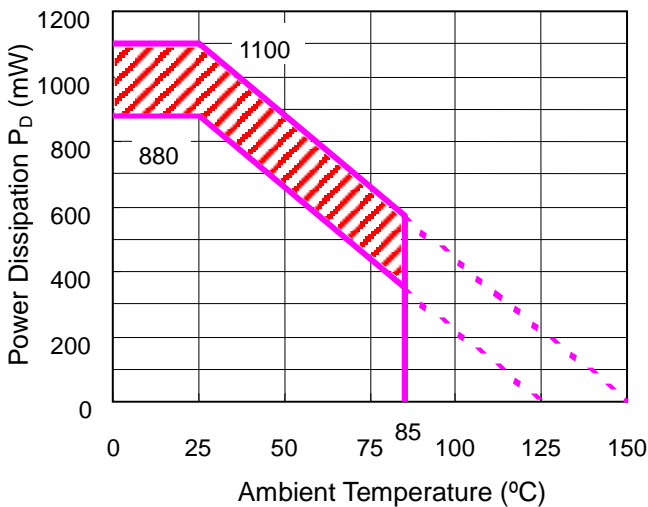

**Power Dissipation**

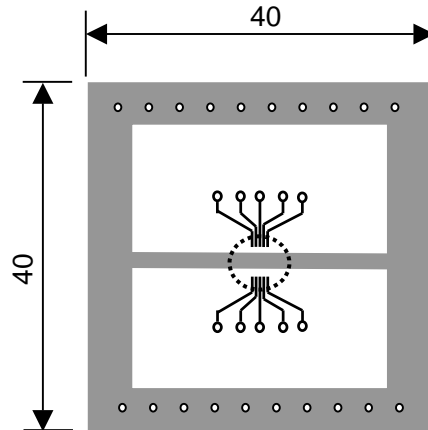

**Measurement Board Pattern**

○ IC Mount Area (Unit: mm)

The above graph shows the Power Dissipation of the package based on  $T_{j\text{max}}=125^\circ\text{C}$  and  $T_{j\text{max}}=150^\circ\text{C}$ . Operating the IC in the shaded area in the graph might have an influence on its lifetime.

Operating time must be within the time limit described in the table below, in case of operating in the shaded area.

Operating Time	Estimated years (Operating 4 hours/day)
13,000 hours	9years



Package Dimensions (DFN(PLP)1820-6)

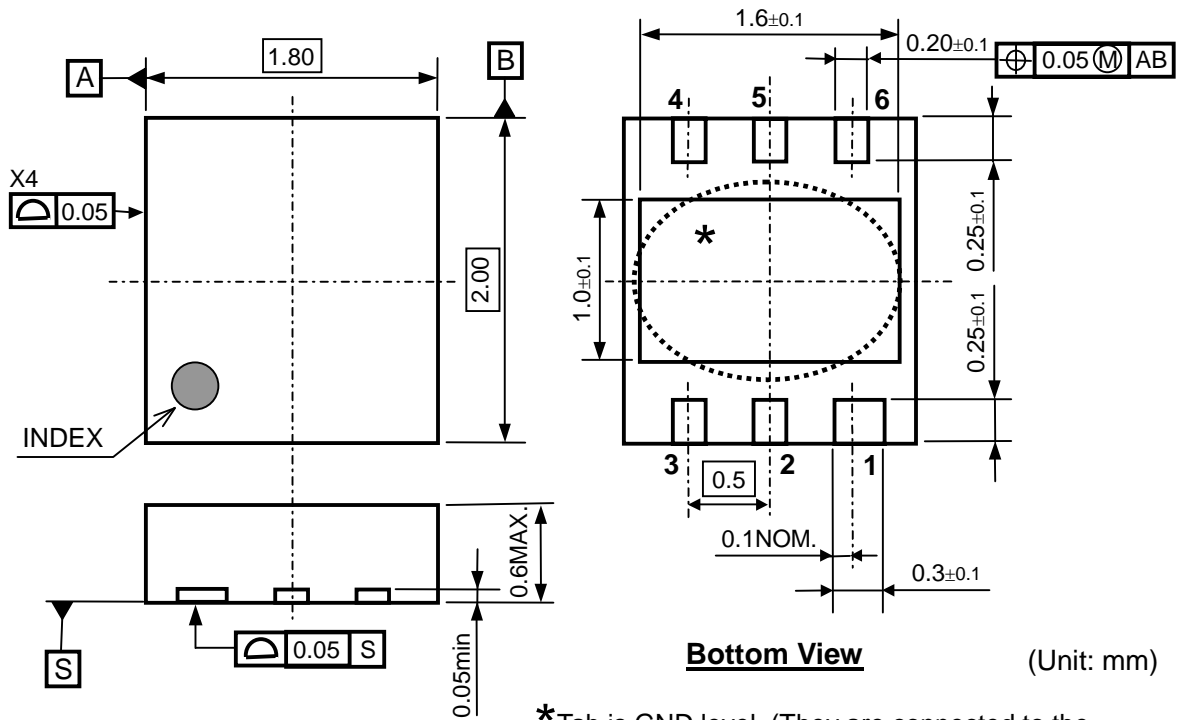

\*Tab is GND level. (They are connected to the reverse side of this IC.)  
The tab is better to be connected to the GND, but leaving it open is also acceptable.

Mark Specifications (DFN(PLP)1820-6)

- ①②③④: Product Code ... Refer to "RP102K Series Mark Specification Table".
- ⑤⑥: Lot Number ... Alphanumeric Serial Number

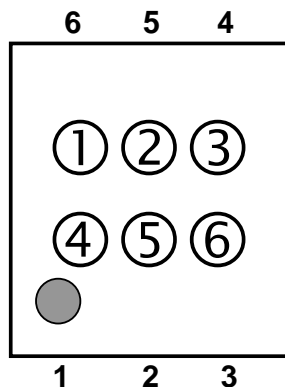

## RP102K Series Mark Specification Table

PKG: DFN(PLP)1820-6

### RP102Kxx1B

Part Number	①②③④	Vset
RP102K121B	<b>AC01</b>	1.2V
RP102K131B	<b>AC02</b>	1.3V
RP102K151B	<b>AC03</b>	1.5V
RP102K181B	<b>AC04</b>	1.8V
RP102K251B	<b>AC05</b>	2.5V
RP102K261B	<b>AC06</b>	2.6V
RP102K281B	<b>AC07</b>	2.8V
RP102K281B5	<b>AC08</b>	2.85V
RP102K291B	<b>AC09</b>	2.9V
RP102K301B	<b>AC10</b>	3.0V
RP102K331B	<b>AC11</b>	3.3V
RP102K181B5	<b>AC12</b>	1.85V
RP102K271B	<b>AC13</b>	2.7V
RP102K121B5	<b>AC14</b>	1.25V
RP102K311B	<b>AC15</b>	3.1V
RP102K171B5	<b>AC16</b>	1.75V
RP102K211B	<b>AC17</b>	2.1V
RP102K141B	<b>AC18</b>	1.4V
RP102K321B	<b>AC19</b>	3.2V
RP102K171B	<b>AC20</b>	1.7V
RP102K201B	<b>AC21</b>	2.0V
RP102K291B5	<b>AC22</b>	2.95V
RP102K321B5	<b>AC23</b>	3.25V
RP102K161B	<b>AC24</b>	1.6V
RP102K191B	<b>AC25</b>	1.9V
RP102K221B	<b>AC26</b>	2.2V
RP102K231B	<b>AC27</b>	2.3V
RP102K241B	<b>AC28</b>	2.4V

### RP102Kxx1D

Part Number	①②③④	Vset
RP102K121D	<b>AD01</b>	1.2V
RP102K131D	<b>AD02</b>	1.3V
RP102K151D	<b>AD03</b>	1.5V
RP102K181D	<b>AD04</b>	1.8V
RP102K251D	<b>AD05</b>	2.5V
RP102K261D	<b>AD06</b>	2.6V
RP102K281D	<b>AD07</b>	2.8V
RP102K281D5	<b>AD08</b>	2.85V
RP102K291D	<b>AD09</b>	2.9V
RP102K301D	<b>AD10</b>	3.0V
RP102K331D	<b>AD11</b>	3.3V
RP102K181D5	<b>AD12</b>	1.85V
RP102K271D	<b>AD13</b>	2.7V
RP102K121D5	<b>AD14</b>	1.25V
RP102K311D	<b>AD15</b>	3.1V
RP102K171D5	<b>AD16</b>	1.75V
RP102K211D	<b>AD17</b>	2.1V
RP102K141D	<b>AD18</b>	1.4V
RP102K321D	<b>AD19</b>	3.2V
RP102K171D	<b>AD20</b>	1.7V
RP102K201D	<b>AD21</b>	2.0V
RP102K291D5	<b>AD22</b>	2.95V
RP102K321D5	<b>AD23</b>	3.25V
RP102K161D	<b>AD24</b>	1.6V
RP102K191D	<b>AD25</b>	1.9V
RP102K221D	<b>AD26</b>	2.2V
RP102K231D	<b>AD27</b>	2.3V
RP102K241D	<b>AD28</b>	2.4V

**Power Dissipation (SOT-23-5)**

This specification is at mounted on board. Power Dissipation ( $P_D$ ) depends on conditions of mounting on board. This specification is based on the measurement at the condition below:

(Power Dissipation (SOT-23-5) is substitution of SOT-23-6.)

Measurement Conditions

	Standard Test Land Pattern
Environment	Mounting on Board (Wind velocity=0m/s)
Board Material	Glass cloth epoxy plastic (Double sided)
Board Dimensions	40mm * 40mm * 1.6mm
Copper Ratio	Top side: Approx. 50%, Back side: Approx. 50%
Through-holes	$\phi$ 0.5mm * 44pcs

Measurement Result

( $T_a=25^\circ\text{C}$ )

	Standard Test Land Pattern	Free Air
Power Dissipation	420mW( $T_{jmax}=125^\circ\text{C}$ ) 525mW( $T_{jmax}=150^\circ\text{C}$ )	250mW( $T_{jmax}=125^\circ\text{C}$ )
Thermal Resistance	$\theta_{ja} = (125-25^\circ\text{C})/0.42\text{W} = 263^\circ\text{C/W}$	400 $^\circ\text{C/W}$

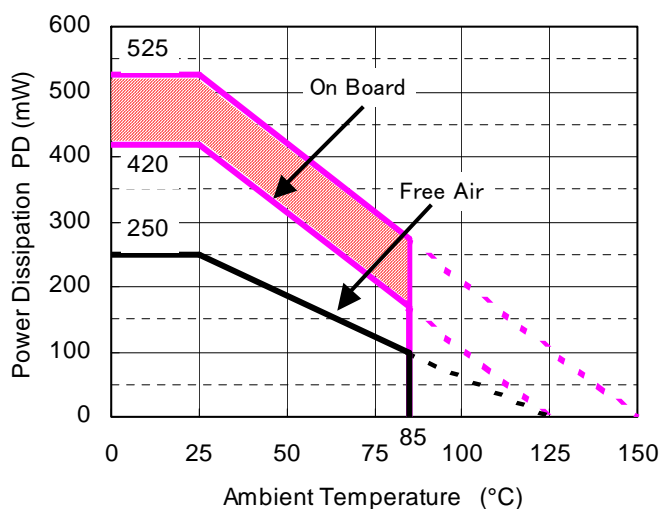

**Power Dissipation**

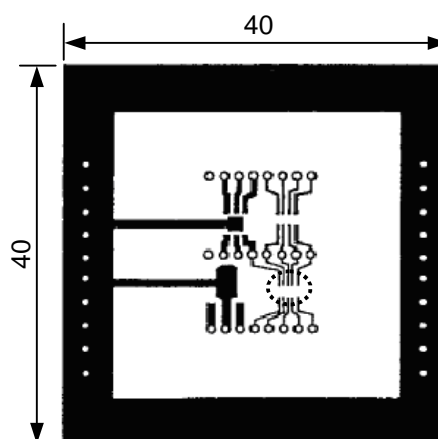

**Measurement Board Pattern**

○ IC Mount Area (Unit: mm)

The above graph shows the Power Dissipation of the package based on  $T_{jmax}=125^\circ\text{C}$  and  $T_{jmax}=150^\circ\text{C}$ . Operating the IC in the shaded area in the graph might have an influence its lifetime. Operating time must be within the time limit described in the table below, in case of operating in the shaded area.

Operating Time	Estimated years (Operating four hours/day)
2,300 hours	1.5years

---

**RP102x**

---

NO.EA-141-160705

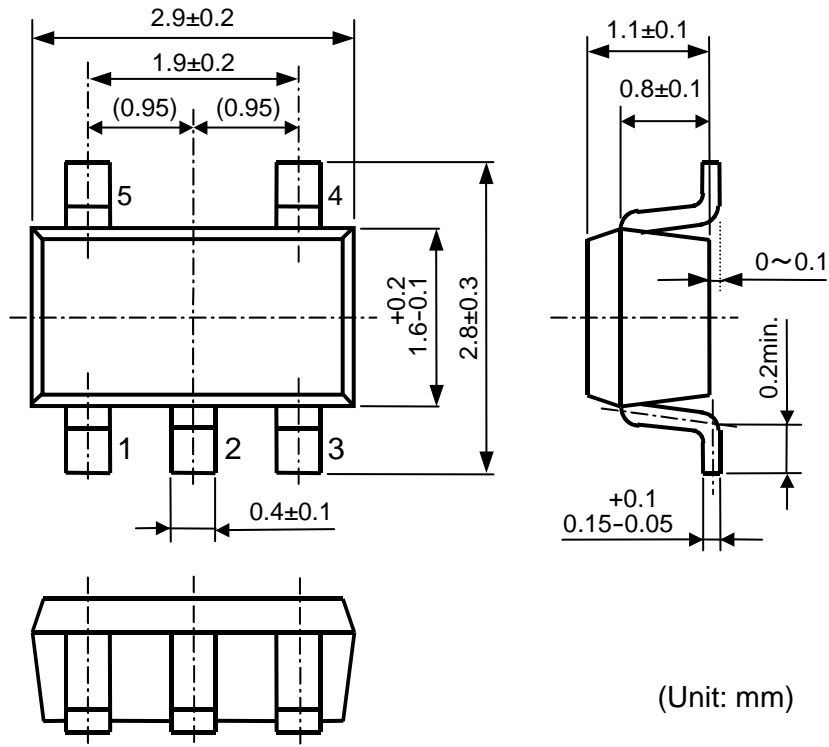
**Package Dimensions (SOT-23-5)****Mark Specifications (SOT-23-5)**

- ①②③: Product Code ... Refer to "RP102N Series Mark Specification Table".  
④⑤: Lot Number ... Alphanumeric Serial Number

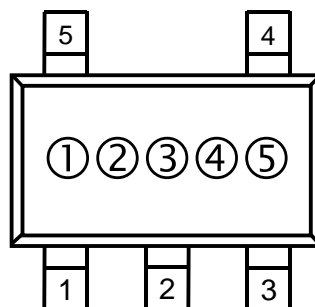

## RP102N Series Mark Specification Table

PKG: SOT-23-5

### RP102Nxx1B

Part Number	①②③	Vset
RP102N121B	<b>60A</b>	1.2V
RP102N131B	<b>60B</b>	1.3V
RP102N151B	<b>60C</b>	1.5V
RP102N181B	<b>60D</b>	1.8V
RP102N251B	<b>60E</b>	2.5V
RP102N261B	<b>60F</b>	2.6V
RP102N281B	<b>60G</b>	2.8V
RP102N281B5	<b>60H</b>	2.85V
RP102N291B	<b>60J</b>	2.9V
RP102N301B	<b>60K</b>	3.0V
RP102N331B	<b>60L</b>	3.3V
RP102N181B5	<b>60M</b>	1.85V
RP102N271B	<b>60N</b>	2.7V
RP102N121B5	<b>60P</b>	1.25V
RP102N311B	<b>60Q</b>	3.1V
RP102N171B5	<b>60R</b>	1.75V
RP102N211B	<b>60S</b>	2.1V
RP102N141B	<b>60T</b>	1.4V
RP102N321B	<b>60U</b>	3.2V
RP102N171B	<b>60V</b>	1.7V
RP102N201B	<b>60W</b>	2.0V
RP102N291B5	<b>60X</b>	2.95V
RP102N321B5	<b>60Y</b>	3.25V
RP102N161B5	<b>60Z</b>	1.6V
RP102N191B5	<b>62A</b>	1.9V
RP102N221B5	<b>62B</b>	2.2V
RP102N231B5	<b>62C</b>	2.3V
RP102N241B5	<b>62D</b>	2.4V

### RP102Nxx1D

Part Number	①②③	Vset
RP102N121D	<b>61A</b>	1.2V
RP102N131D	<b>61B</b>	1.3V
RP102N151D	<b>61C</b>	1.5V
RP102N181D	<b>61D</b>	1.8V
RP102N251D	<b>61E</b>	2.5V
RP102N261D	<b>61F</b>	2.6V
RP102N281D	<b>61G</b>	2.8V
RP102N281D5	<b>61H</b>	2.85V
RP102N291D	<b>61J</b>	2.9V
RP102N301D	<b>61K</b>	3.0V
RP102N331D	<b>61L</b>	3.3V
RP102N181D5	<b>61M</b>	1.85V
RP102N271D	<b>61N</b>	2.7V
RP102N121D5	<b>61P</b>	1.25V
RP102N311D	<b>61Q</b>	3.1V
RP102N171D5	<b>61R</b>	1.75V
RP102N211D	<b>61S</b>	2.1V
RP102N141D	<b>61T</b>	1.4V
RP102N321D	<b>61U</b>	3.2V
RP102N171D	<b>61V</b>	1.7V
RP102N201D	<b>61W</b>	2.0V
RP102N291D5	<b>61X</b>	2.95V
RP102N321D5	<b>61Y</b>	3.25V
RP102N161D	<b>61Z</b>	1.6V
RP102N191D	<b>63A</b>	1.9V
RP102N221D	<b>63B</b>	2.2V
RP102N231D	<b>63C</b>	2.3V
RP102N241D	<b>63D</b>	2.4V



1. The products and the product specifications described in this document are subject to change or discontinuation of production without notice for reasons such as improvement. Therefore, before deciding to use the products, please refer to Ricoh sales representatives for the latest information thereon.
2. The materials in this document may not be copied or otherwise reproduced in whole or in part without prior written consent of Ricoh.
3. Please be sure to take any necessary formalities under relevant laws or regulations before exporting or otherwise taking out of your country the products or the technical information described herein.
4. The technical information described in this document shows typical characteristics of and example application circuits for the products. The release of such information is not to be construed as a warranty of or a grant of license under Ricoh's or any third party's intellectual property rights or any other rights.
5. The products listed in this document are intended and designed for use as general electronic components in standard applications (office equipment, telecommunication equipment, measuring instruments, consumer electronic products, amusement equipment etc.). Those customers intending to use a product in an application requiring extreme quality and reliability, for example, in a highly specific application where the failure or misoperation of the product could result in human injury or death (aircraft, spacevehicle, nuclear reactor control system, traffic control system, automotive and transportation equipment, combustion equipment, safety devices, life support system etc.) should first contact us.
6. We are making our continuous effort to improve the quality and reliability of our products, but semiconductor products are likely to fail with certain probability. In order to prevent any injury to persons or damages to property resulting from such failure, customers should be careful enough to incorporate safety measures in their design, such as redundancy feature, fire containment feature and fail-safe feature. We do not assume any liability or responsibility for any loss or damage arising from misuse or inappropriate use of the products.
7. Anti-radiation design is not implemented in the products described in this document.
8. The X-ray exposure can influence functions and characteristics of the products. Confirm the product functions and characteristics in the evaluation stage.
9. WLCSP products should be used in light shielded environments. The light exposure can influence functions and characteristics of the products under operation or storage.
10. There can be variation in the marking when different AOI (Automated Optical Inspection) equipment is used. In the case of recognizing the marking characteristic with AOI, please contact Ricoh sales or our distributor before attempting to use AOI.
11. Please contact Ricoh sales representatives should you have any questions or comments concerning the products or the technical information.



**Ricoh is committed to reducing the environmental loading materials in electrical devices with a view to contributing to the protection of human health and the environment.**

Ricoh has been providing RoHS compliant products since April 1, 2006 and Halogen-free products since April 1, 2012.

**RICOH** RICOH ELECTRONIC DEVICES CO., LTD.

<https://www.e-devices.ricoh.co.jp/en/>

#### Sales & Support Offices

##### **Ricoh Electronic Devices Co., Ltd.**

##### **Shin-Yokohama Office (International Sales)**

2-3, Shin-Yokohama 3-chome, Kohoku-ku, Yokohama-shi, Kanagawa, 222-8530, Japan  
Phone: +81-50-3814-7687 Fax: +81-45-474-0074

##### **Ricoh Americas Holdings, Inc.**

675 Campbell Technology Parkway, Suite 200 Campbell, CA 95008, U.S.A.  
Phone: +1-408-610-3105

##### **Ricoh Europe (Netherlands) B.V.**

##### **Semiconductor Support Centre**

Prof. W.H. Keesomlaan 1, 1183 DJ Amstelveen, The Netherlands  
Phone: +31-20-5474-309

##### **Ricoh International B.V. - German Branch**

##### **Semiconductor Sales and Support Centre**

Oberrather Strasse 6, 40472 Düsseldorf, Germany  
Phone: +49-211-6546-0

##### **Ricoh Electronic Devices Korea Co., Ltd.**

3F, Haesung Bldg, 504, Teheran-ro, Gangnam-gu, Seoul, 135-725, Korea  
Phone: +82-2-2135-5700 Fax: +82-2-2051-5713

##### **Ricoh Electronic Devices Shanghai Co., Ltd.**

Room 403, No.2 Building, No.690 Bibo Road, Pu Dong New District, Shanghai 201203,  
People's Republic of China  
Phone: +86-21-5027-3200 Fax: +86-21-5027-3299

##### **Ricoh Electronic Devices Shanghai Co., Ltd.**

##### **Shenzhen Branch**

1205, Block D (Jinlong Building), Kingkey 100, Hongbao Road, Luohu District,  
Shenzhen, China  
Phone: +86-755-8348-7600 Ext 225

##### **Ricoh Electronic Devices Co., Ltd.**

##### **Taipei office**

Room 109, 10F-1, No.51, Hengyang Rd., Taipei City, Taiwan (R.O.C.)  
Phone: +886-2-2313-1621/1622 Fax: +886-2-2313-1623

