

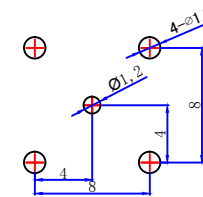

Product NO.		DOSIN-801-0469		
REV	DESCRIPTION	DWN	DATE	APPROVEN
A	First issue	CHEN	2017/11/02	John kine

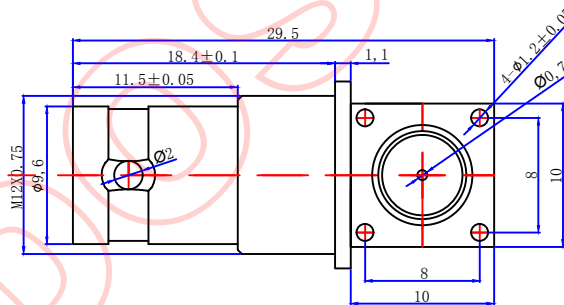
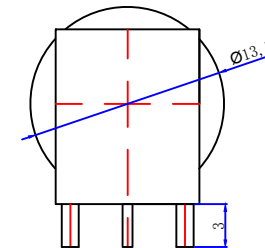
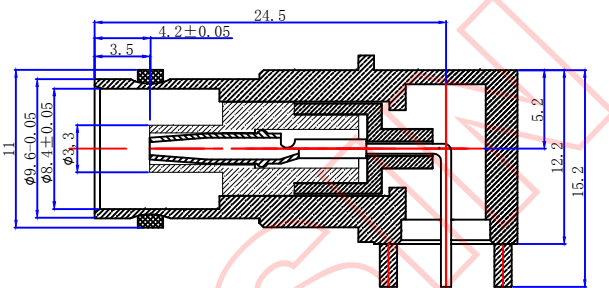
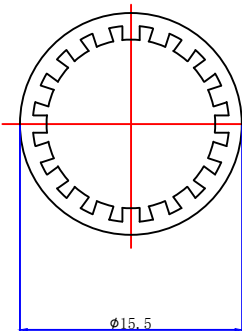
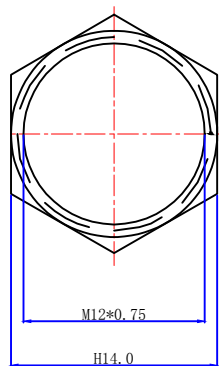

### Specifications

Impedance: 75 Ohms  
 Frequency Range: DC~3G  
 VSWR: 1.3MAX  
 Working Voltage: 500V rms @ sea level  
 Insulation Resistance: 5000 Ohms min  
 Temperature Range: -55°C TO +155°C  
 Relative Temperature: ≤95% (40°C ±2°C)  
 Drawings products are in line with ROHS standards

NOTE:

Tolerance

0-6 ±0.2  
 6-30 ±0.3  
 30-120 ±0.5  
 Angular ±2°



Dosin Industrial(H.K)Co.Ltd

E-mail: dosin2005@163.com  
 dosin2005@dosing-china.com  
 Web: http://www.dosin.com  
 TEL: (0086)769-81153906  
 FAX: (0086)769-81875836

东莞市德索五金电子制品有限公司

Dosin Hardware Electronics Co.,Ltd

Name: BNC JACK FOR PCB CONNECTOR DNN

SIZE A Product NO. DOSIN-801-0469 REV A

DateTime 2017/11/02 CAD FILE D/company drawings/BD SHEET: 1 OF 1

E	WASHER	IRON	NICKEL	1
D	NUT	BRASS	NICKEL	1
C	INSULATOR	POM	WHITE	1
B	CONTACT PLATINC	BRASS	GOLD	1
A	BODY	ZINC	NICKEL	1
NO	DESCRIPTION	MATERIAL	FINISHED	QTY

DRAWN  
 Zelin. CHEN  
 CHECKED

APPROVALS  
 John

View

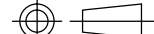

UNIT

MM

SCALE

1:1

A

B

King

D

E

F

G