

High speed 1200 V TRENCHSTOP™ IGBT 7 Technology co-packed with full rated current, soft-commutating, ultra-fast recovery and low Q_{rr} emitter controlled 7 Rapid diode

Features

- $V_{CE} = 1200\text{ V}$
- $I_C = 50\text{ A}$
- Maximum junction temperature $T_{vjmax} = 175^\circ\text{C}$
- Best-in-class high speed IGBT co-packed with full rated current, low Q_{rr} and soft-commutating high speed diode
- Low saturation voltage $V_{CEsat} = 1.7\text{ V}$ at $T_{vj} = 25^\circ\text{C}$
- Optimized for high efficiency in high speed hard switching topologies (2-L inverter, 3-L NPC T-type, ...)
- Easy paralleling capability due to positive temperature coefficient in V_{CEsat}
- Pb-free lead plating; RoHS compliant
- Complete product spectrum and PSpice Models: <http://www.infineon.com/igbt/>

Potential applications

- Industrial UPS
- EV-Charging
- String inverter
- Welding

Product validation

- Qualified for industrial applications according to the relevant tests of JEDEC47/20/22

Description

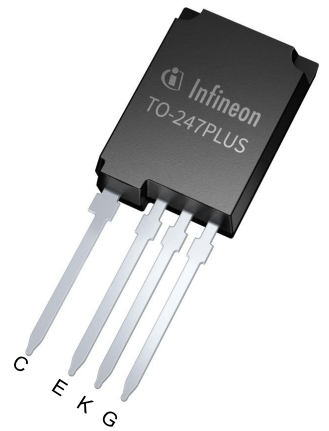

- Lead-free
- Green
- Halogen-free
- RoHS

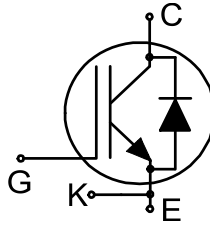

Type	Package	Marking
IKY50N120CH7	PG-TO247-4-PLUS-NN5.1	K50MCH7

Table of contents

	Description	1
	Features	1
	Potential applications	1
	Product validation	1
	Table of contents	2
1	Package	3
2	IGBT	3
3	Diode	5
4	Characteristics diagrams	7
5	Package outlines	14
6	Testing conditions	15
	Revision history	16
	Disclaimer	17

1 Package

Table 1 Characteristic values

Parameter	Symbol	Note or test condition	Values			Unit
			Min.	Typ.	Max.	
Internal emitter inductance measured 5 mm (0.197 in.) from case	L_E			13		nH
Storage temperature	T_{stg}		-55		150	°C
Soldering temperature	T_{sold}	wave soldering 1.6 mm (0.063 in.) from case for 10 s			260	°C
Thermal resistance, junction-ambient	$R_{th(j-a)}$				40	K/W
IGBT thermal resistance, junction-case	$R_{th(j-c)}$			0.29	0.38	K/W
Diode thermal resistance, junction-case	$R_{th(j-c)}$			0.51	0.66	K/W

2 IGBT

Table 2 Maximum rated values

Parameter	Symbol	Note or test condition	Values	Unit	
Collector-emitter voltage	V_{CE}	$T_{vj} \geq 25\text{ °C}$	1200	V	
DC collector current, limited by T_{vjmax}	I_C	limited by bondwire	$T_c = 25\text{ °C}$	75	A
			$T_c = 100\text{ °C}$	65	
Pulsed collector current, t_p limited by T_{vjmax}	I_{Cpulse}		200	A	
Turn-off safe operating area		$V_{CC} \leq 800\text{ V}$, $V_{CE,peak} < 1200\text{ V}$, $V_{GE} = 0/15\text{ V}$, $R_{Goff} \geq 23\ \Omega$, $T_{vj} \leq 175\text{ °C}$	200	A	
Gate-emitter voltage	V_{GE}		± 20	V	
Transient gate-emitter voltage	V_{GE}	$t_p \leq 0.5\ \mu\text{s}$, $D < 0.001$	± 25	V	
Power dissipation	P_{tot}		$T_c = 25\text{ °C}$	398	W
			$T_c = 100\text{ °C}$	199	

Table 3 Characteristic values

Parameter	Symbol	Note or test condition	Values			Unit
			Min.	Typ.	Max.	
Collector-emitter saturation voltage	V_{CEsat}	$I_C = 50\text{ A}$, $V_{GE} = 15\text{ V}$	$T_{vj} = 25\text{ °C}$	1.7	2.15	V
			$T_{vj} = 175\text{ °C}$	2		

(table continues...)

Table 3 (continued) Characteristic values

Parameter	Symbol	Note or test condition	Values			Unit
			Min.	Typ.	Max.	
Gate-emitter threshold voltage	V_{GEth}	$I_C = 0.8 \text{ mA}, V_{CE} = V_{GE}$	4.7	5.5	6.2	V
Zero gate-voltage collector current	I_{CES}	$V_{CE} = 1200 \text{ V}, V_{GE} = 0 \text{ V}$	$T_{vj} = 25 \text{ }^\circ\text{C}$		40	μA
			$T_{vj} = 175 \text{ }^\circ\text{C}$		3500	
Gate-emitter leakage current	I_{GES}	$V_{CE} = 0 \text{ V}, V_{GE} = 20 \text{ V}$			100	nA
Transconductance	g_{fs}	$I_C = 50 \text{ A}, V_{CE} = 20 \text{ V}$		93		S
Input capacitance	C_{ies}	$V_{CE} = 25 \text{ V}, V_{GE} = 0 \text{ V}, f = 100 \text{ kHz}$		6.6		nF
Output capacitance	C_{oes}	$V_{CE} = 25 \text{ V}, V_{GE} = 0 \text{ V}, f = 100 \text{ kHz}$		134		pF
Reverse transfer capacitance	C_{res}	$V_{CE} = 25 \text{ V}, V_{GE} = 0 \text{ V}, f = 100 \text{ kHz}$		38		pF
Gate charge	Q_G	$V_{CC} = 960 \text{ V}, I_C = 50 \text{ A}, V_{GE} = 15 \text{ V}$		372		nC
Turn-on delay time	$t_{d(on)}$	$V_{CC} = 600 \text{ V}, V_{GE} = 0/15 \text{ V}, R_{G(on)} = 8 \text{ } \Omega, R_{G(off)} = 8 \text{ } \Omega$	$T_{vj} = 25 \text{ }^\circ\text{C}, I_C = 50 \text{ A}$		35	ns
			$T_{vj} = 175 \text{ }^\circ\text{C}, I_C = 50 \text{ A}$		33	
Rise time (inductive load)	t_r	$V_{CC} = 600 \text{ V}, V_{GE} = 0/15 \text{ V}, R_{G(on)} = 8 \text{ } \Omega, R_{G(off)} = 8 \text{ } \Omega$	$T_{vj} = 25 \text{ }^\circ\text{C}, I_C = 50 \text{ A}$		13	ns
			$T_{vj} = 175 \text{ }^\circ\text{C}, I_C = 50 \text{ A}$		16	
Turn-off delay time	$t_{d(off)}$	$V_{CC} = 600 \text{ V}, V_{GE} = 0/15 \text{ V}, R_{G(on)} = 8 \text{ } \Omega, R_{G(off)} = 8 \text{ } \Omega$	$T_{vj} = 25 \text{ }^\circ\text{C}, I_C = 50 \text{ A}$		331	ns
			$T_{vj} = 175 \text{ }^\circ\text{C}, I_C = 50 \text{ A}$		423	
Fall time (inductive load)	t_f	$V_{CC} = 600 \text{ V}, V_{GE} = 0/15 \text{ V}, R_{G(on)} = 8 \text{ } \Omega, R_{G(off)} = 8 \text{ } \Omega$	$T_{vj} = 25 \text{ }^\circ\text{C}, I_C = 50 \text{ A}$		42	ns
			$T_{vj} = 175 \text{ }^\circ\text{C}, I_C = 50 \text{ A}$		117	
Turn-on energy	E_{on}	$V_{CC} = 600 \text{ V}, V_{GE} = 0/15 \text{ V}, R_{G(on)} = 8 \text{ } \Omega, R_{G(off)} = 8 \text{ } \Omega$	$T_{vj} = 25 \text{ }^\circ\text{C}, I_C = 50 \text{ A}$		1.09	mJ
			$T_{vj} = 175 \text{ }^\circ\text{C}, I_C = 50 \text{ A}$		1.89	
Turn-off energy	E_{off}	$V_{CC} = 600 \text{ V}, V_{GE} = 0/15 \text{ V}, R_{G(on)} = 8 \text{ } \Omega, R_{G(off)} = 8 \text{ } \Omega$	$T_{vj} = 25 \text{ }^\circ\text{C}, I_C = 50 \text{ A}$		1.33	mJ
			$T_{vj} = 175 \text{ }^\circ\text{C}, I_C = 50 \text{ A}$		2.76	

(table continues...)

Table 3 (continued) Characteristic values

Parameter	Symbol	Note or test condition	Values			Unit	
			Min.	Typ.	Max.		
Total switching energy	E_{ts}	$V_{CC} = 600\text{ V}, V_{GE} = 0/15\text{ V}, R_{G(on)} = 8\ \Omega, R_{G(off)} = 8\ \Omega$	$T_{vj} = 25\text{ }^\circ\text{C}, I_C = 50\text{ A}$		2.42		mJ
			$T_{vj} = 175\text{ }^\circ\text{C}, I_C = 50\text{ A}$		4.65		
Operating junction temperature	T_{vj}		-40		175	$^\circ\text{C}$	

Note: Electrical Characteristic, at $T_{vj} = 25^\circ\text{C}$, unless otherwise specified.

3 Diode

Table 4 Maximum rated values

Parameter	Symbol	Note or test condition	Values	Unit	
Diode forward current, limited by T_{vjmax}	I_F	limited by bondwire	$T_c = 25\text{ }^\circ\text{C}$	70	A
			$T_c = 100\text{ }^\circ\text{C}$	51	
Diode pulsed current, t_p limited by T_{vjmax}	I_{Fpulse}		200	A	
Power dissipation	P_{tot}		$T_c = 25\text{ }^\circ\text{C}$	226	W
			$T_c = 100\text{ }^\circ\text{C}$	113	

Table 5 Characteristic values

Parameter	Symbol	Note or test condition	Values			Unit	
			Min.	Typ.	Max.		
Diode forward voltage	V_F	$I_F = 50\text{ A}$	$T_{vj} = 25\text{ }^\circ\text{C}$		2.5	3	V
			$T_{vj} = 175\text{ }^\circ\text{C}$		2.3		
Diode reverse recovery time	t_{rr}	$V_R = 600\text{ V}, R_{G(on)} = 8\ \Omega$	$T_{vj} = 25\text{ }^\circ\text{C}, I_F = 50\text{ A}$		86		ns
			$T_{vj} = 175\text{ }^\circ\text{C}, I_F = 50\text{ A}$		169		
Diode reverse recovery charge	Q_{rr}	$V_R = 600\text{ V}, R_{G(on)} = 8\ \Omega$	$T_{vj} = 25\text{ }^\circ\text{C}, I_F = 50\text{ A}$		1.71		μC
			$T_{vj} = 175\text{ }^\circ\text{C}, I_F = 50\text{ A}$		5.48		
Diode peak reverse recovery current	I_{rrm}	$V_R = 600\text{ V}, R_{G(on)} = 8\ \Omega$	$T_{vj} = 25\text{ }^\circ\text{C}, I_F = 50\text{ A}$		60		A
			$T_{vj} = 175\text{ }^\circ\text{C}, I_F = 50\text{ A}$		106		

(table continues...)

Table 5 (continued) Characteristic values

Parameter	Symbol	Note or test condition	Values			Unit	
			Min.	Typ.	Max.		
Diode peak rate of fall of reverse recovery current	di_{rr}/dt	$V_R = 600 \text{ V}, R_{G(on)} = 8 \text{ } \Omega$	$T_{vj} = 25 \text{ } ^\circ\text{C},$ $I_F = 50 \text{ A}$		-1500		A/ μs
			$T_{vj} = 175 \text{ } ^\circ\text{C},$ $I_F = 50 \text{ A}$		-2490		
Reverse recovery energy	E_{rec}	$V_R = 600 \text{ V}, R_{G(on)} = 8 \text{ } \Omega$	$T_{vj} = 25 \text{ } ^\circ\text{C},$ $I_F = 50 \text{ A}$		0.64		mJ
			$T_{vj} = 175 \text{ } ^\circ\text{C},$ $I_F = 50 \text{ A}$		2.3		
Operating junction temperature	T_{vj}			-40		175	$^\circ\text{C}$

Note: For optimum lifetime and reliability, Infineon recommends operating conditions that do not exceed 80% of the maximum ratings stated in this datasheet.

Dynamic test circuit, parasitic inductance $L_\sigma = 30 \text{ nH}$, $C_\sigma = 18 \text{ pF}$

4 Characteristics diagrams

Reverse bias safe operating area

$I_C = f(V_{CE})$
 $V_{GE} = 0/15\text{ V}, T_{vj} \leq 175\text{ °C}$

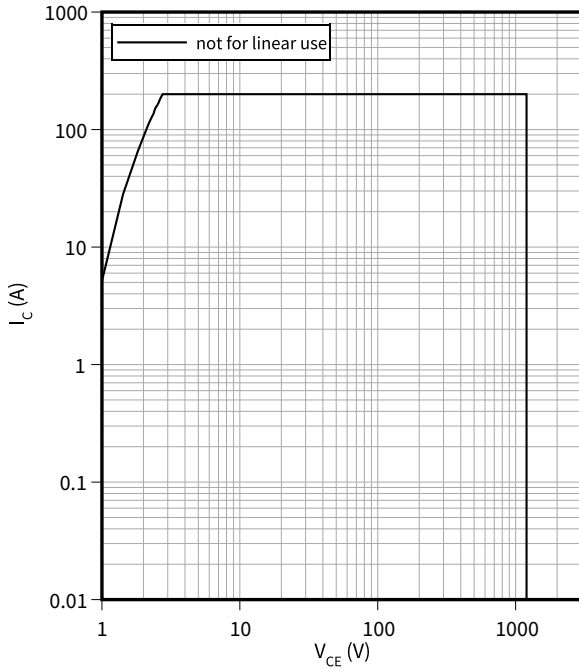

Typical output characteristic

$I_C = f(V_{CE})$
 $T_{vj} = 25\text{ °C}$

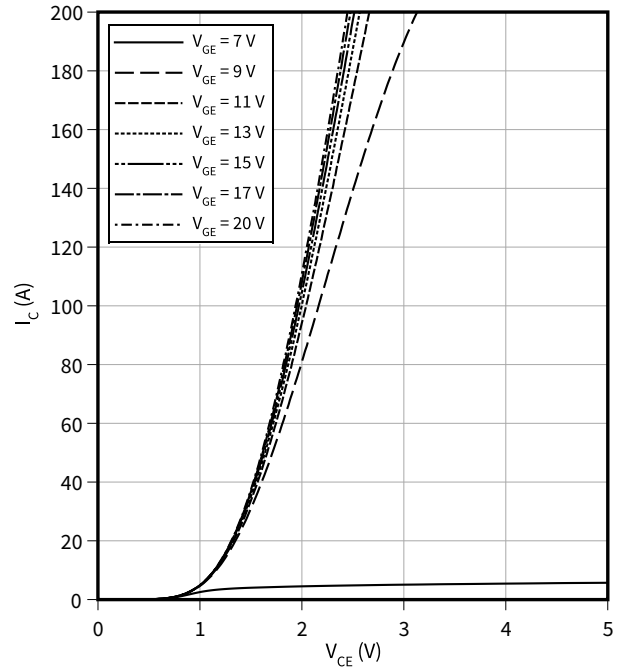

Typical output characteristic

$I_C = f(V_{CE})$
 $T_{vj} = 175\text{ °C}$

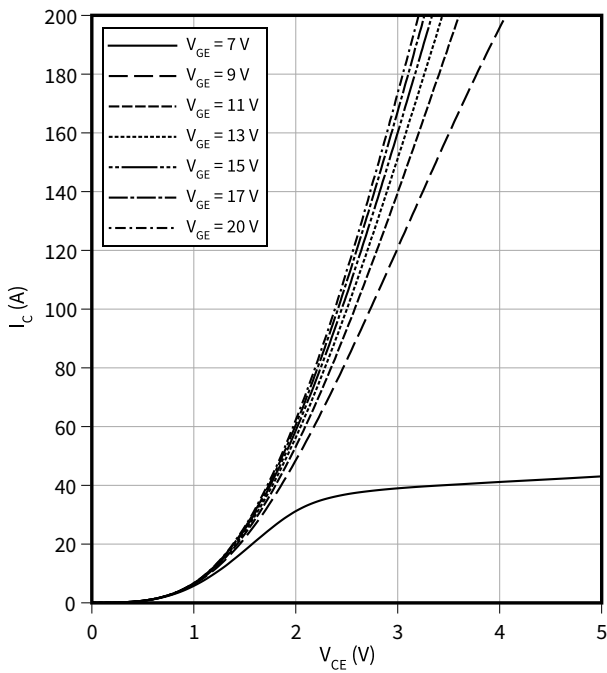

Typical transfer characteristic

$I_C = f(V_{GE})$
 $V_{CE} = 20\text{ V}$

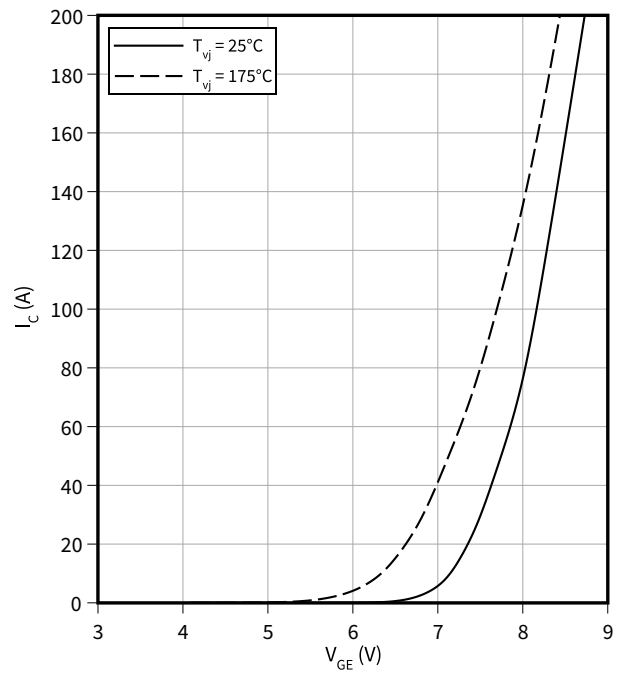

4 Characteristics diagrams

Typical collector-emitter saturation voltage as a function of junction temperature

$V_{CEsat} = f(T_{vj})$
 $V_{GE} = 15 \text{ V}$

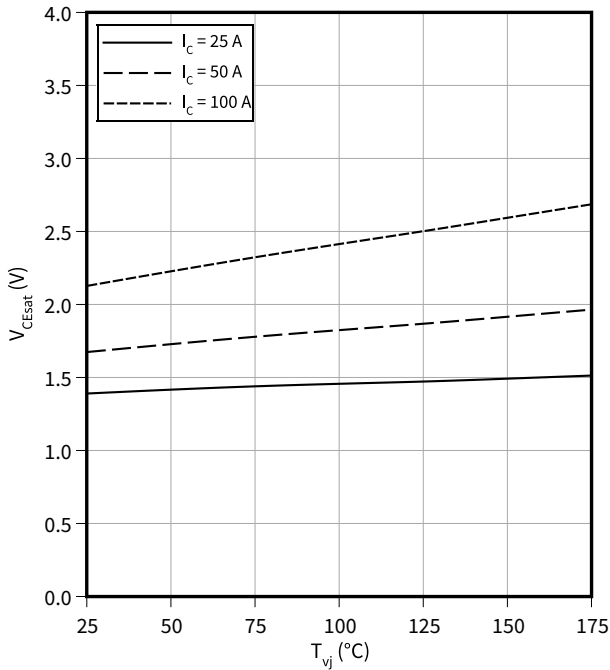

Gate-emitter threshold voltage as a function of junction temperature

$V_{Geth} = f(T_{vj})$
 $I_c = 0.8 \text{ mA}$

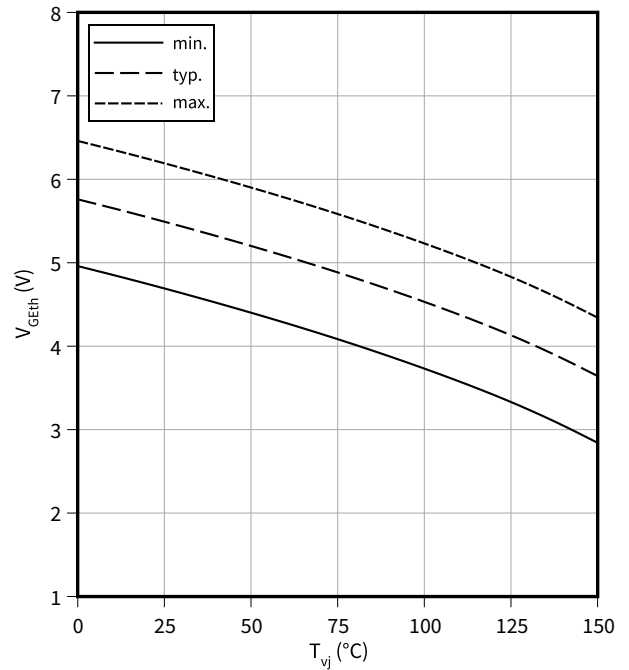

Typical switching times as a function of collector current

$t = f(I_c)$
 $V_{CC} = 600 \text{ V}, T_{vj} = 175 \text{ °C}, V_{GE} = 0/15 \text{ V}, R_G = 8 \text{ } \Omega$

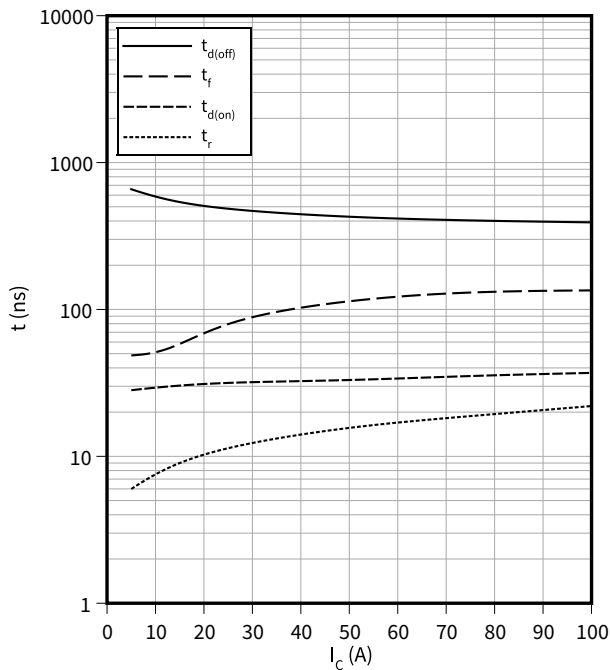

Typical switching times as a function of gate resistor

$t = f(R_G)$
 $I_c = 50 \text{ A}, V_{CC} = 600 \text{ V}, T_{vj} = 175 \text{ °C}, V_{GE} = 0/15 \text{ V}$

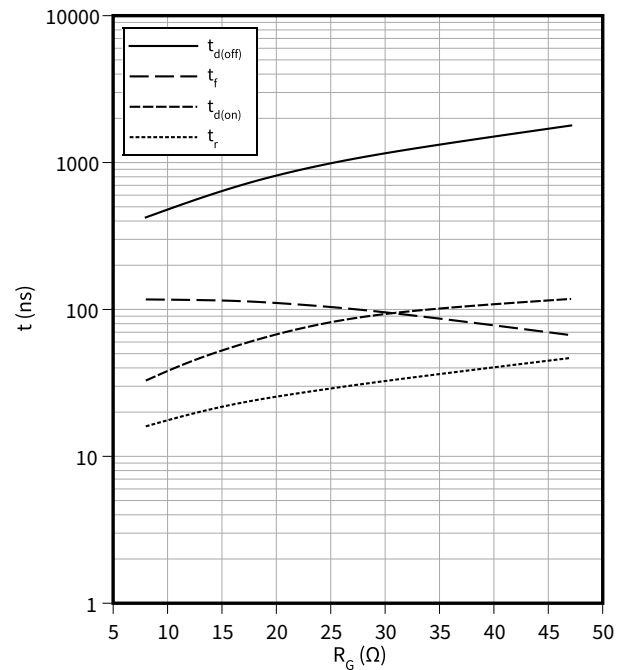

4 Characteristics diagrams

Typical switching times as a function of junction temperature

$t = f(T_{vj})$

$I_C = 50 \text{ A}, V_{CC} = 600 \text{ V}, V_{GE} = 0/15 \text{ V}, R_G = 8 \Omega$

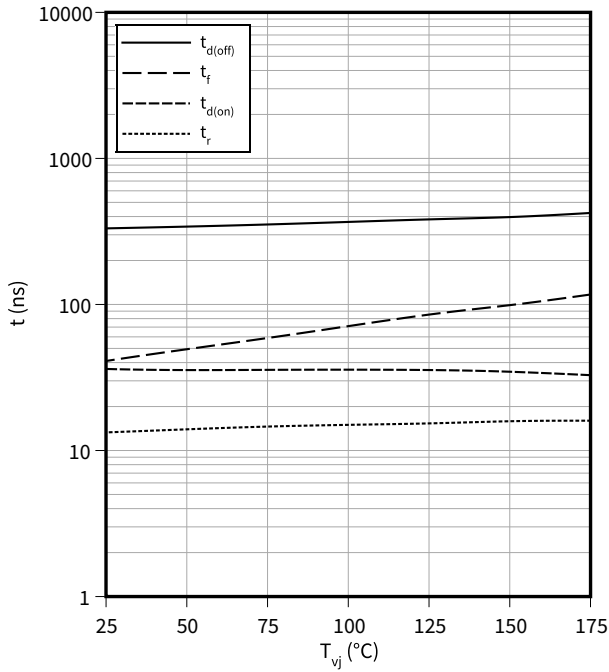

Typical switching energy losses as a function of collector current

$E = f(I_C)$

$V_{CC} = 600 \text{ V}, T_{vj} = 175 \text{ °C}, V_{GE} = 0/15 \text{ V}, R_G = 8 \Omega$

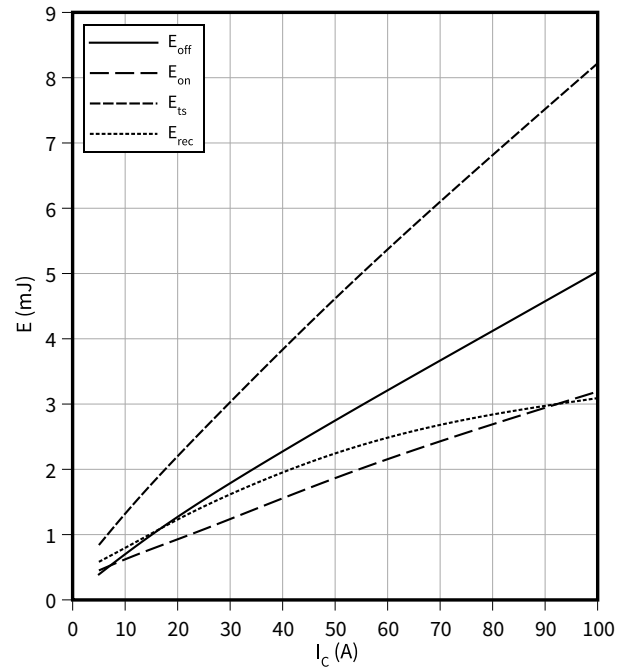

Typical switching energy losses as a function of gate resistor

$E = f(R_G)$

$I_C = 50 \text{ A}, V_{CC} = 600 \text{ V}, T_{vj} = 175 \text{ °C}, V_{GE} = 0/15 \text{ V}$

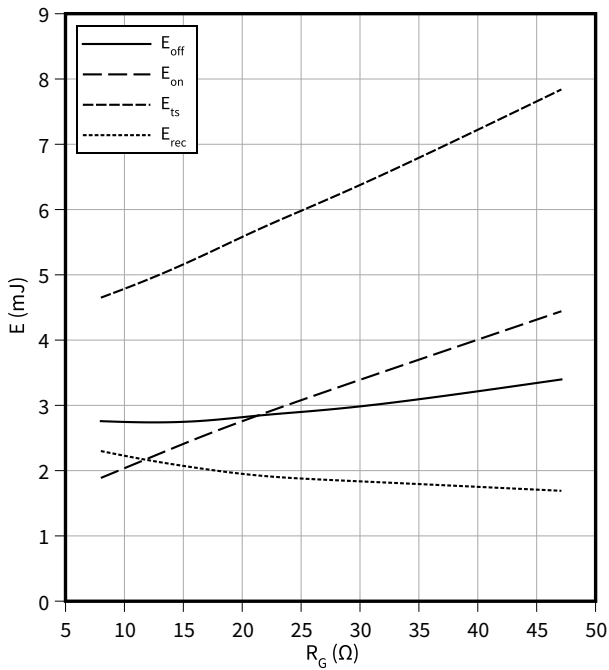

Typical switching energy losses as a function of junction temperature

$E = f(T_{vj})$

$I_C = 50 \text{ A}, V_{CC} = 600 \text{ V}, V_{GE} = 0/15 \text{ V}, R_G = 8 \Omega$

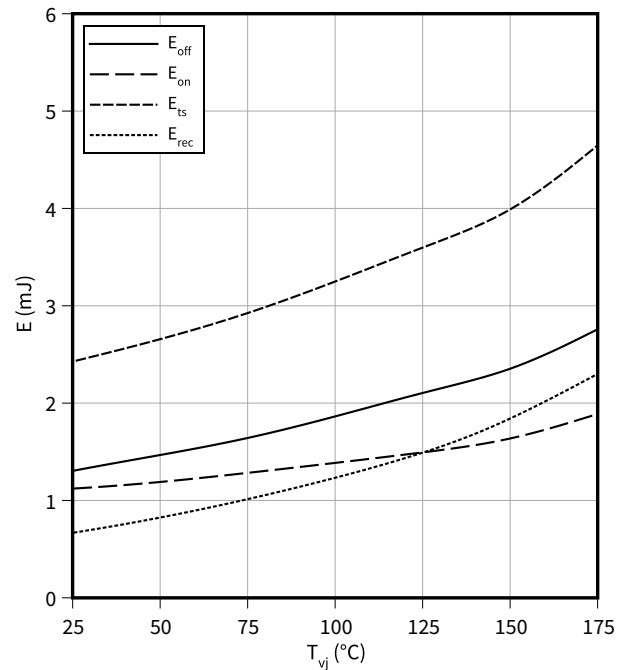

4 Characteristics diagrams

Typical switching energy losses as a function of collector emitter voltage

$E = f(V_{CE})$

$I_C = 50 \text{ A}, V_{GE} = 0/15 \text{ V}, T_{vj} = 175 \text{ °C}, R_G = 8 \text{ } \Omega$

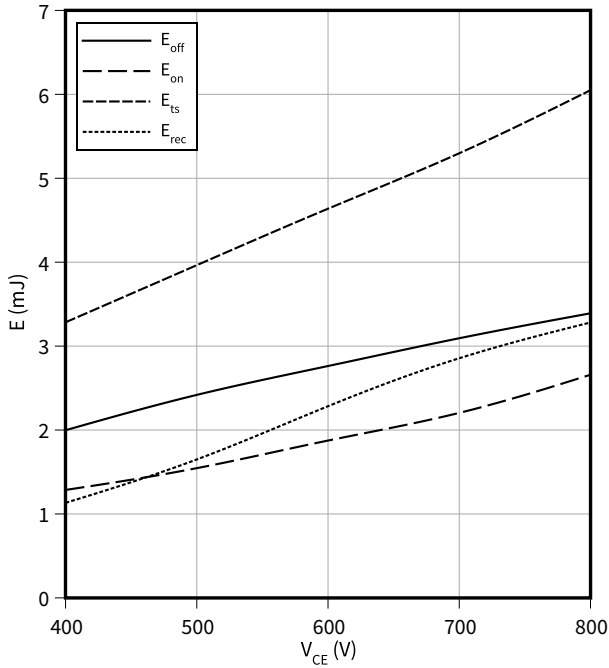

Typical gate charge

$V_{GE} = f(Q_G)$

$I_C = 50 \text{ A}$

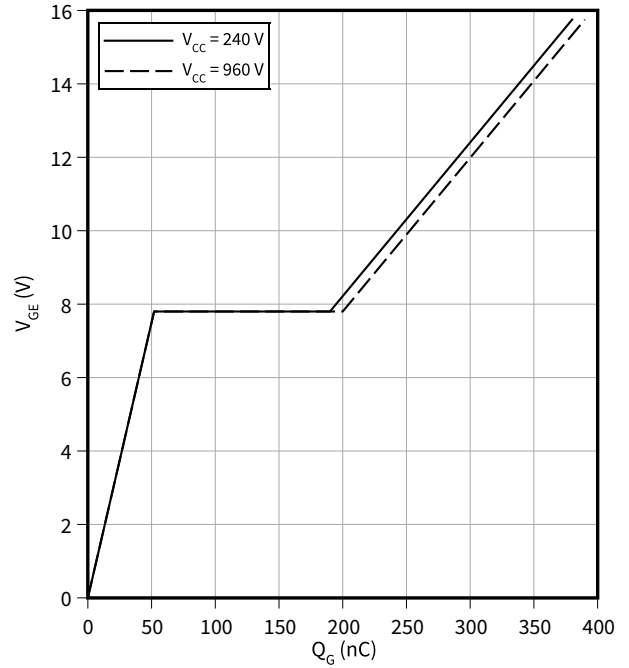

Typical capacitance as a function of collector-emitter voltage

$C = f(V_{CE})$

$f = 100 \text{ kHz}, V_{GE} = 0 \text{ V}$

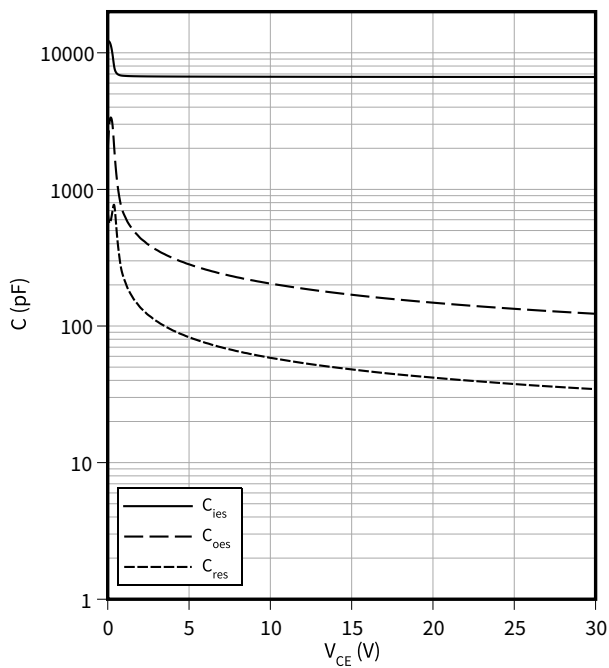

IGBT transient thermal impedance as a function of pulse width

$Z_{th(j-c)} = f(t_p)$

$D = t_p/T$

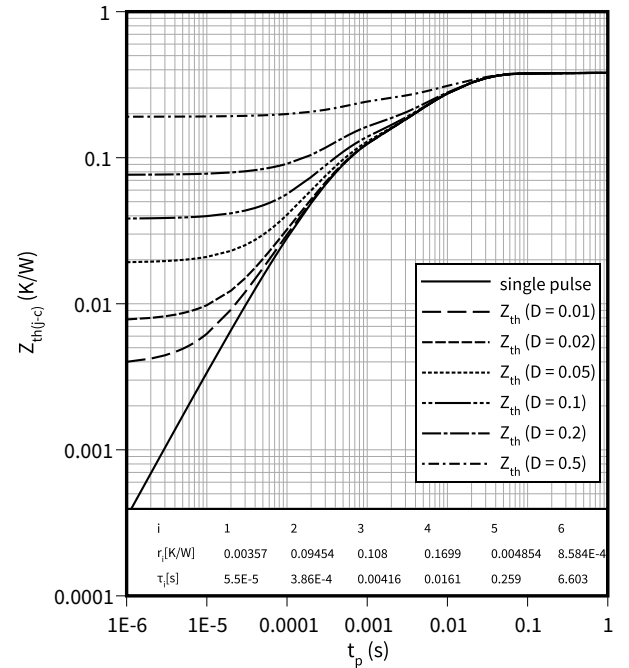

4 Characteristics diagrams

Diode transient thermal impedance as a function of pulse width

$Z_{th(j-c)} = f(t_p)$
 $D = t_p/T$

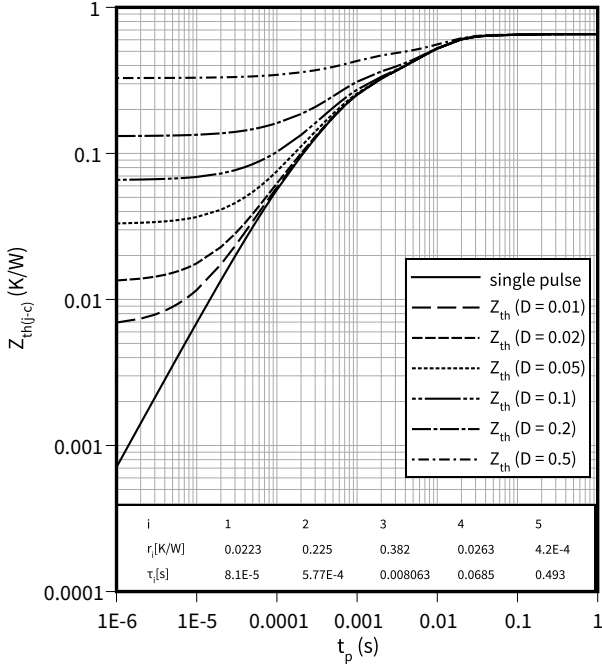

Typical diode forward current as a function of forward voltage

$I_F = f(V_F)$

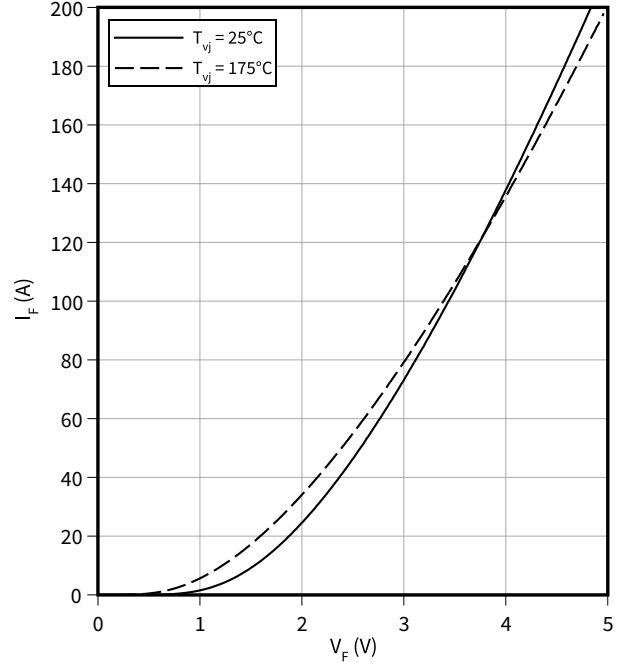

Typical diode forward voltage as a function of junction temperature

$V_F = f(T_{vj})$

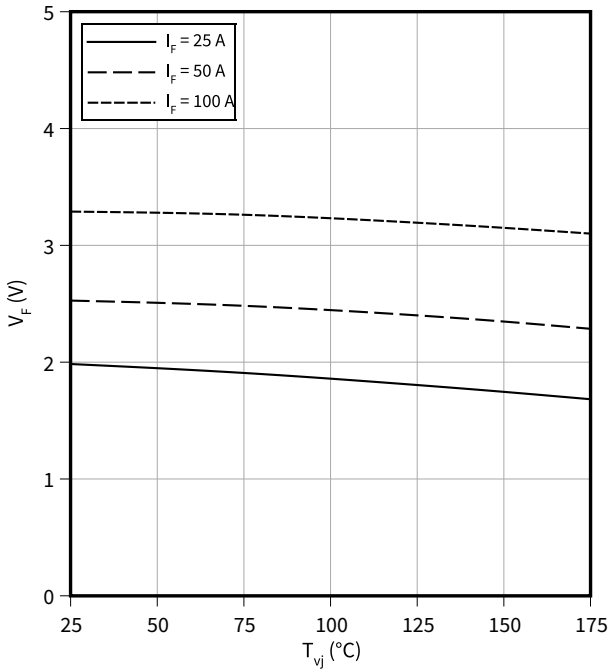

Typical reverse recovery time as a function of diode current slope

$t_{rr} = f(di_F/dt)$
 $V_R = 600 \text{ V}, I_F = 50 \text{ A}$

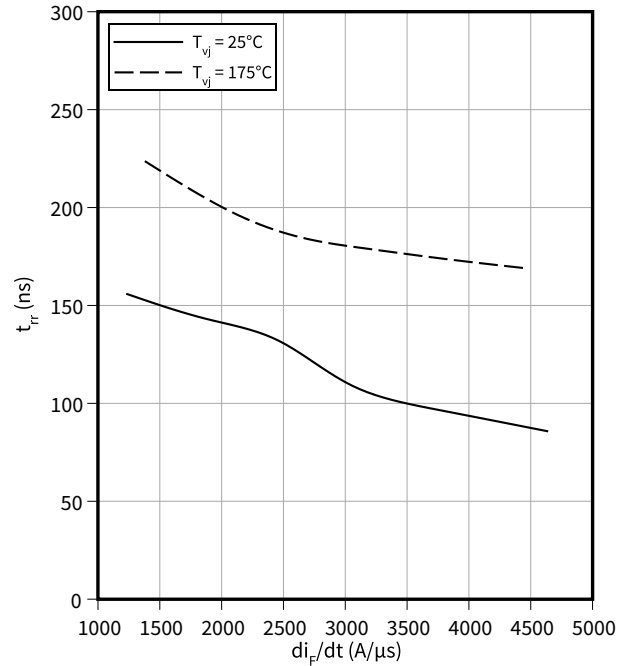

4 Characteristics diagrams

Typical reverse recovery charge as a function of diode current slope

$Q_{rr} = f(di_F/dt)$

$V_R = 600\text{ V}, I_F = 50\text{ A}$

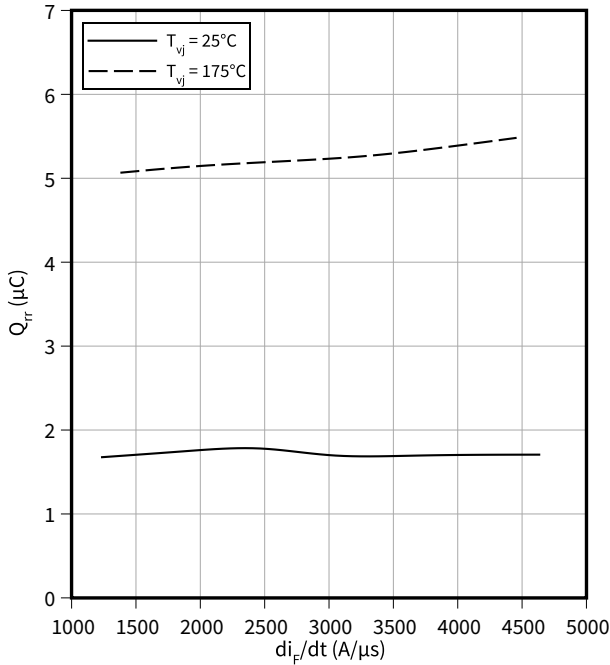

Typical reverse recovery current as a function of diode current slope

$I_{rrm} = f(di_F/dt)$

$V_R = 600\text{ V}, I_F = 50\text{ A}$

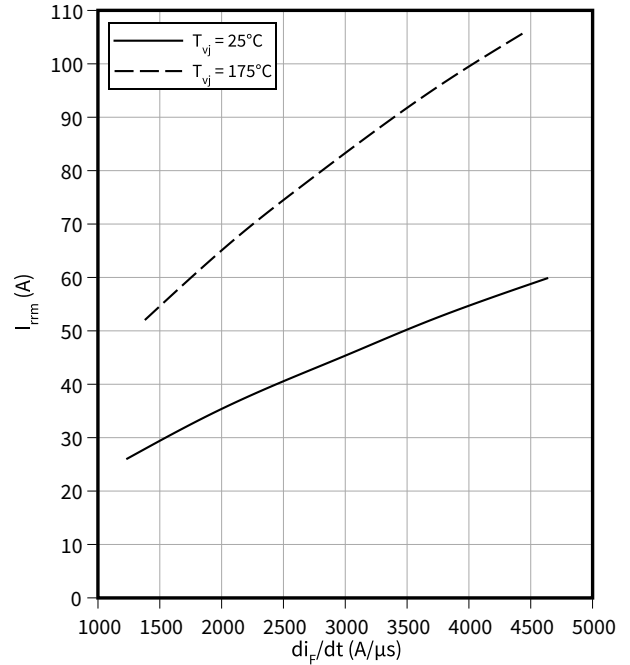

Typical diode peak rate of fall of reverse recovery current as a function of diode current slope

$di_{rr}/dt = f(di_F/dt)$

$V_R = 600\text{ V}, I_F = 50\text{ A}$

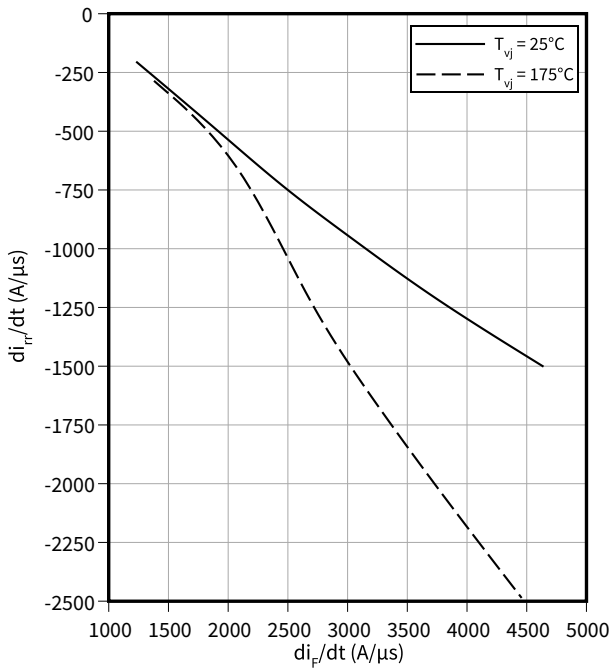

Typical reverse energy losses as a function of diode current slope

$E_{rec} = f(di_F/dt)$

$V_R = 600\text{ V}, I_F = 50\text{ A}$

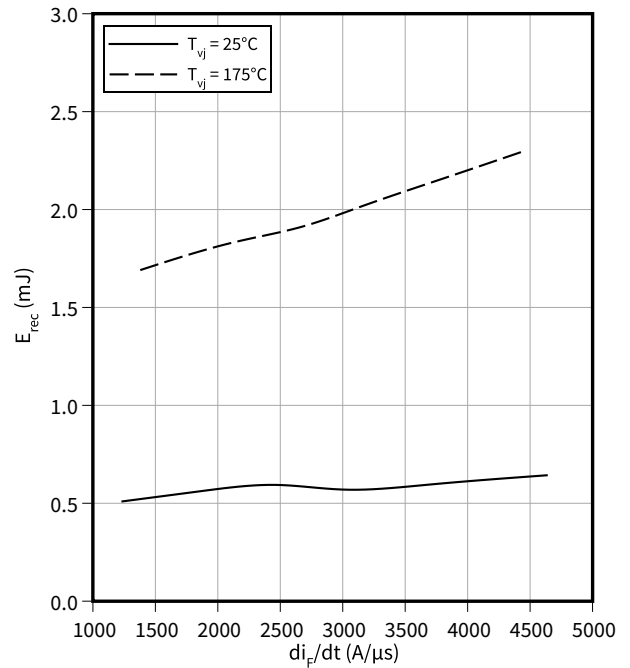

Typical diode current slope as a function of gate resistor

$$di_F/dt = f(R_G)$$

$V_R = 600 \text{ V}$, $I_F = 50 \text{ A}$

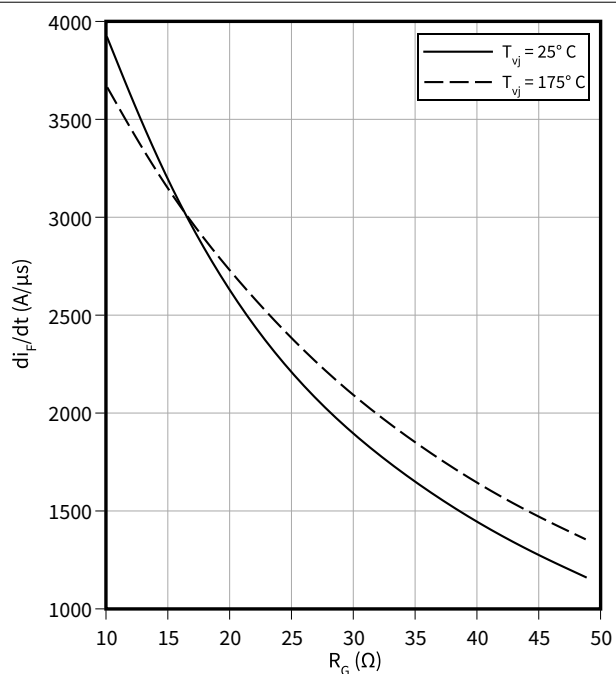

5 Package outlines

PG-TO247-4-PLUS-NN5.1

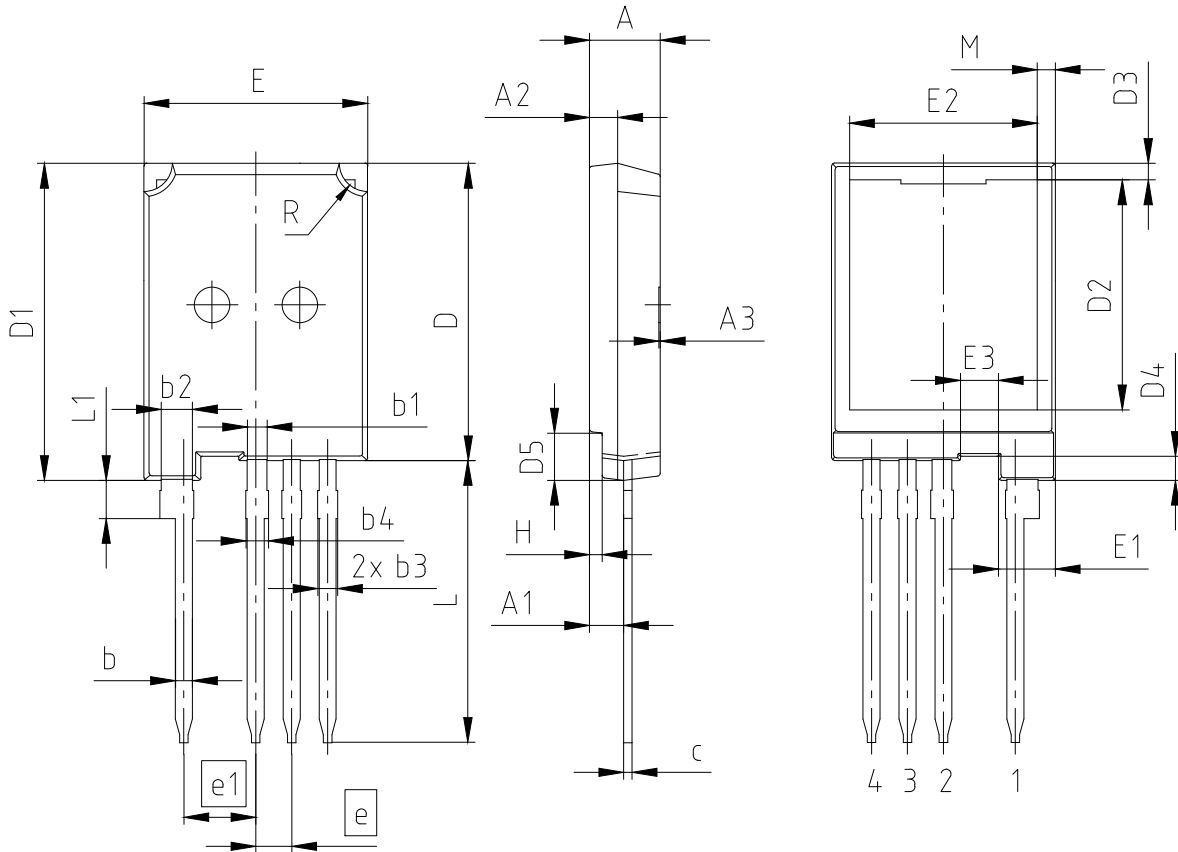

NOTES:
 PACKAGE SURFACE ROUTE BETWEEN PIN 1 & PIN 2 WILL BE 5.1 mm MIN.
 ALL b... AND c DIMENSIONS INCLUDING PLATING EXPECT AREA OF CUTTING

PACKAGE - GROUP NUMBER:		PG-TO247-4-U10			
DIMENSIONS	MILLIMETERS		DIMENSIONS	MILLIMETERS	
	MIN.	MAX.		MIN.	MAX.
A	4.90	5.10	E	15.70	15.90
A1	2.31	2.51	E1	3.90	4.10
A2	1.90	2.10	E2	13.10	13.50
b	1.16	1.29	E3	2.58	2.78
b1	1.36	1.49	e	2.54	
b2	2.16	2.29	e1	5.08	
b3	1.16	1.45	H	0.80	1.00
b4	1.16	1.65	N	4	
c	0.59	0.66	L	19.80	20.10
D	20.90	21.10	L1	2.55	2.85
D1	22.30	22.50	M	0.97	1.57
D2	15.95	16.55	R	1.90	2.10
D3	1.00	1.35			
D4	1.60	1.80			
D5	3.24	3.44			

Figure 1

6 Testing conditions



Figure 2

Revision history

Document revision	Date of release	Description of changes
0.10	2022-05-02	Target datasheet
0.20	2022-06-01	Editorial changes
1.00	2022-11-29	Final datasheet
1.10	2023-01-17	Change of product outline drawing on page 14
1.20	2023-07-21	Figures on page 10 updated Editorial changes

Trademarks

All referenced product or service names and trademarks are the property of their respective owners.

Edition 2023-07-21

Published by

Infineon Technologies AG

81726 Munich, Germany

© 2023 Infineon Technologies AG

All Rights Reserved.

Do you have a question about any aspect of this document?

Email: erratum@infineon.com

Document reference

IFX-ABB387-005

Important notice

The information given in this document shall in no event be regarded as a guarantee of conditions or characteristics ("Beschaffheitsgarantie").

With respect to any examples, hints or any typical values stated herein and/or any information regarding the application of the product, Infineon Technologies hereby disclaims any and all warranties and liabilities of any kind, including without limitation warranties of non-infringement of intellectual property rights of any third party.

In addition, any information given in this document is subject to customer's compliance with its obligations stated in this document and any applicable legal requirements, norms and standards concerning customer's products and any use of the product of Infineon Technologies in customer's applications.

The data contained in this document is exclusively intended for technically trained staff. It is the responsibility of customer's technical departments to evaluate the suitability of the product for the intended application and the completeness of the product information given in this document with respect to such application.

Please note that this product is not qualified according to the AEC Q100 or AEC Q101 documents of the Automotive Electronics Council.

Warnings

Due to technical requirements products may contain dangerous substances. For information on the types in question please contact your nearest Infineon Technologies office.

Except as otherwise explicitly approved by Infineon Technologies in a written document signed by authorized representatives of Infineon Technologies, Infineon Technologies' products may not be used in any applications where a failure of the product or any consequences of the use thereof can reasonably be expected to result in personal injury.