

TSA40N25M

250V N-Channel MOSFET

General Description

This Power MOSFET is produced using Truesemi's advanced planar stripe DMOS technology. This advanced technology has been especially tailored to minimize on-state resistance, provide superior switching performance, and withstand high energy pulse in the avalanche and commutation mode. These devices are well suited for high efficiency switched mode power supplies, active power factor correction based on half bridge topology.

Features

- 40A,250V,Max.RDS(on)=85mΩ @ VGS=10V
- Low gate charge:Qg=62nC (Typ.)
- Low reverse transfer capacitance: Crss=40pF (Typ.)
- Lower EMI noise
- 100% avalanche tested
- RoHS compliant device

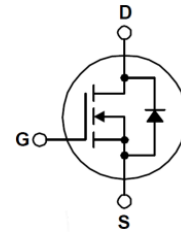
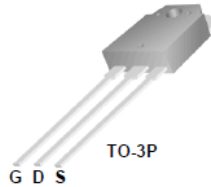

Absolute Maximum Ratings T_C=25°C unless otherwise specified

Symbol	Parameter	TSA40N25M	Units
V _{DSS}	Drain-Source Voltage	250	V
V _{GS}	Gate-Source Voltage	± 30	V
I _D	Drain Current	T _C = 25°C	40
		T _C = 100°C	25.3
I _{DM}	Pulsed Drain Current (Note 1)	160	A
E _{AS}	Single Pulsed Avalanche Energy (Note 2)	1000	mJ
I _{AR}	Repetitive avalanche current (Note 1)	40	A
E _{AR}	Repetitive Avalanche Energy (Note 1)	5.8	mJ
P _D	Power Dissipation	260	W
T _J , T _{STG}	Operating and Storage Temperature Range	-55 to +150	°C

* Drain current limited by maximum junction temperature.

Thermal Resistance Characteristics

Symbol	Parameter	Rating	Units
R _{θJC}	Thermal Resistance,Junction-to-Case	Max.0.48	°C/W
R _{θJA}	Thermal Resistance,Junction-to-Ambient	Max.62.5	°C/W

Electrical Characteristics $T_C=25^\circ\text{C}$ unless otherwise specified

Symbol	Parameter	Test Conditions	Min	Typ	Max	Units
--------	-----------	-----------------	-----	-----	-----	-------

On Characteristics

V_{GS}	Gate Threshold Voltage	$V_{DS} = V_{GS}, I_D = 250 \mu\text{A}$	2.0	--	4.0	V
$R_{DS(ON)}$	Static Drain-Source On-Resistance	$V_{GS} = 10 \text{ V}, I_D = 20 \text{ A}$	--	70	85	m Ω

Off Characteristics

BV_{DSS}	Drain-Source Breakdown Voltage	$V_{GS} = 0 \text{ V}, I_D = 250 \mu\text{A}$	250	--	--	V
$\Delta BV_{DSS} / \Delta T_J$	Breakdown Voltage Temperature Coefficient	$I_D = 250 \mu\text{A}$, Referenced to 25°C	--	1	--	V/ $^\circ\text{C}$
I_{DSS}	Zero Gate Voltage Drain Current	$V_{DS} = 250 \text{ V}, V_{GS} = 0 \text{ V}$	--	--	10	μA
		$V_{DS} = 250 \text{ V}, T_J = 125^\circ\text{C}$	--	--	100	μA
I_{GSSF}	Gate-Body Leakage Current, Forward	$V_{GS} = 20 \text{ V}, V_{DS} = 0 \text{ V}$	--	--	100	nA
I_{GSSR}	Gate-Body Leakage Current, Reverse	$V_{GS} = -20 \text{ V}, V_{DS} = 0 \text{ V}$	--	--	-100	nA

Dynamic Characteristics

C_{iss}	Input Capacitance	$V_{DS} = 25 \text{ V}, V_{GS} = 0 \text{ V}, f = 1.0 \text{ MHz}$	--	2704	--	pF
C_{oss}	Output Capacitance		--	325	--	pF
C_{rss}	Reverse Transfer Capacitance		--	40	--	pF

Switching Characteristics

$t_{d(on)}$	Turn-On Time	$V_{DS} = 125 \text{ V}, I_D = 20 \text{ A}, R_G = 25 \Omega$ (Note 3,4)	--	42	--	ns
t_r	Turn-On Rise Time		--	26	--	ns
$t_{d(off)}$	Turn-Off Delay Time		--	155	--	ns
t_f	Turn-Off Fall Time		--	32	--	ns
Q_g	Total Gate Charge	$V_{DS} = 125 \text{ V}, I_D = 20 \text{ A}, V_{GS} = 10 \text{ V}$ (Note 3,4)	--	62	--	nC
Q_{gs}	Gate-Source Charge		--	16	--	nC
Q_{gd}	Gate-Drain Charge		--	18	--	nC

Source-Drain Diode Maximum Ratings and Characteristics

I_S	Continuous Source-Drain Diode Forward Current	--	--	40	A	
I_{SM}	Pulsed Source-Drain Diode Forward Current	--	--	160		
V_{SD}	Source-Drain Diode Forward Voltage	$I_S = 40 \text{ A}, V_{GS} = 0 \text{ V}$	--	--	1.4	V
t_{rr}	Reverse Recovery Time	$I_S = 20 \text{ A}, V_{GS} = 0 \text{ V}$	--	167	--	ns
Q_{rr}	Reverse Recovery Charge	$di_F/dt = 100 \text{ A}/\mu\text{s}$ (Note 3,4)	--	1.25	--	μC

NOTES:

1. Repetitive Rating: Pulse width limited by safe operating area
2. $L=1\text{mH}, I_{AS}=40\text{A}, V_{DD}=50\text{V}, R_G=25 \Omega$, Starting $T_J=25^\circ\text{C}$
3. Pulse test: Pulse width $\leq 300\mu\text{s}$, Duty cycle $\leq 2\%$
4. Essentially independent of operating temperature typical characteristics

Typical Electrical Characteristics Curves

Fig. 1 Typical Output Characteristics

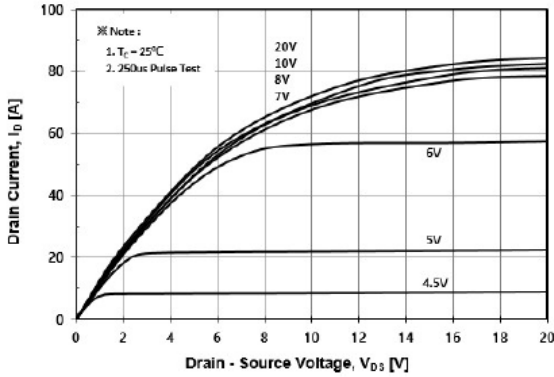

Fig. 2 Typical Transfer Characteristics

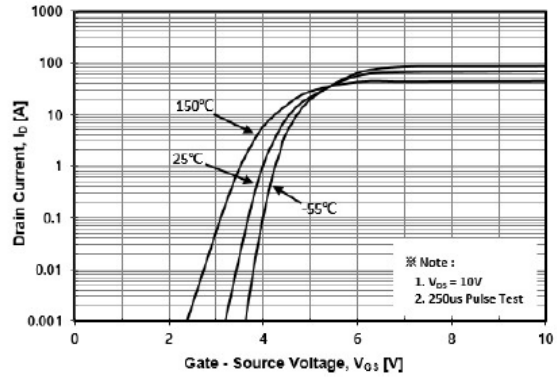

Fig.3 On-Resistance Variation with Drain Current and Gate Voltage

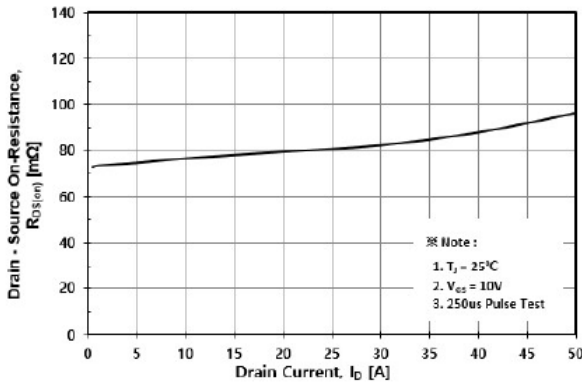

Fig. 4 Body Diode Forward Voltage Variation with Source Current

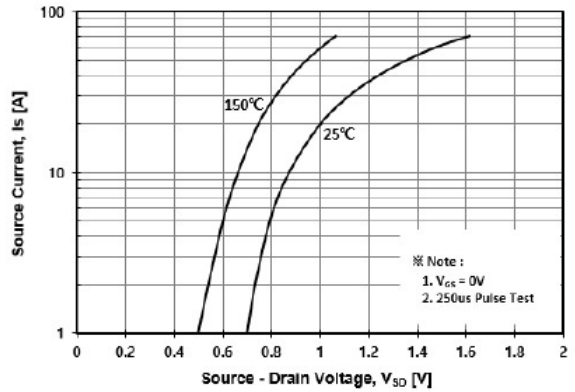

Fig. 5 Typical Capacitance Characteristics

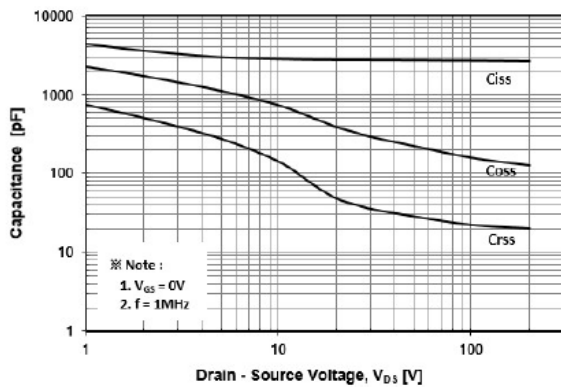
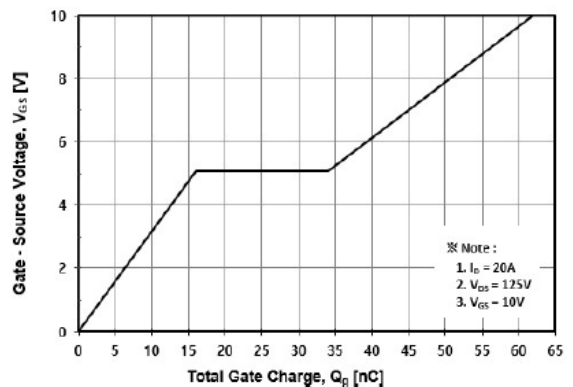

Fig. 6 Typical Total Gate Charge Characteristics



Typical Electrical Characteristics Curves

Fig. 7 Breakdown Voltage Variation vs. Temperature

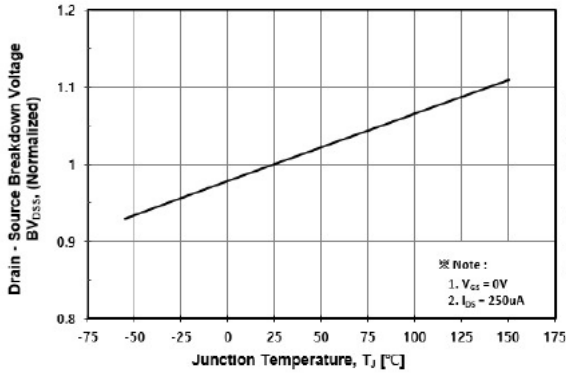

Fig. 8 On-Resistance Variation vs. Temperature

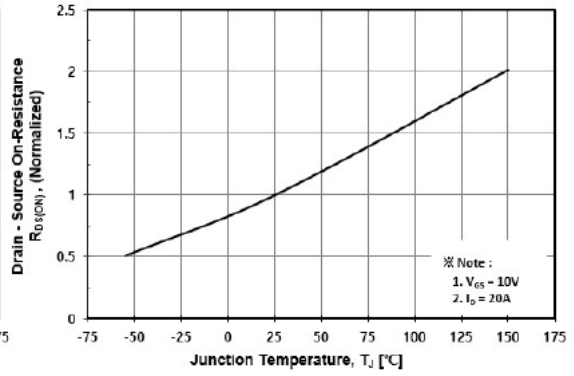

Fig. 9 Maximum Drain Current vs. Case Temperature

Fig. 9 Maximum Drain Current vs. Case Temperature

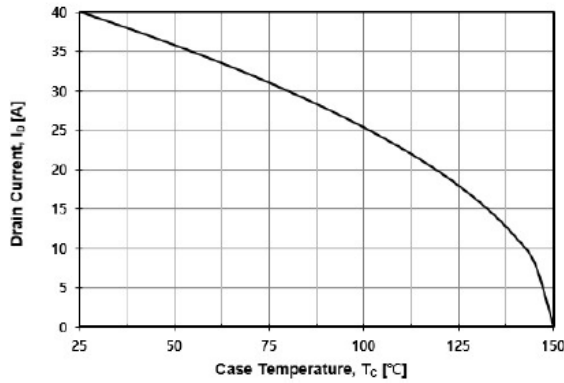

Fig. 10 Maximum Safe Operating Area

Fig. 10 Maximum Safe Operating Area

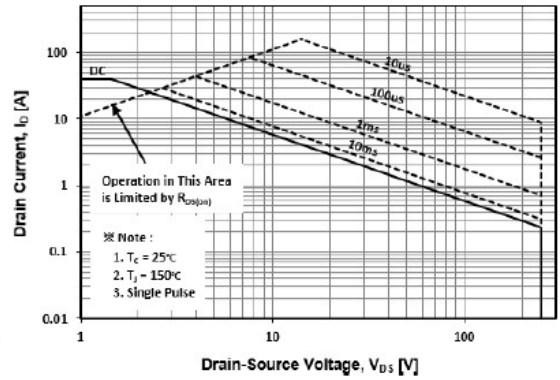

Fig. 11 Transient Thermal Impedance

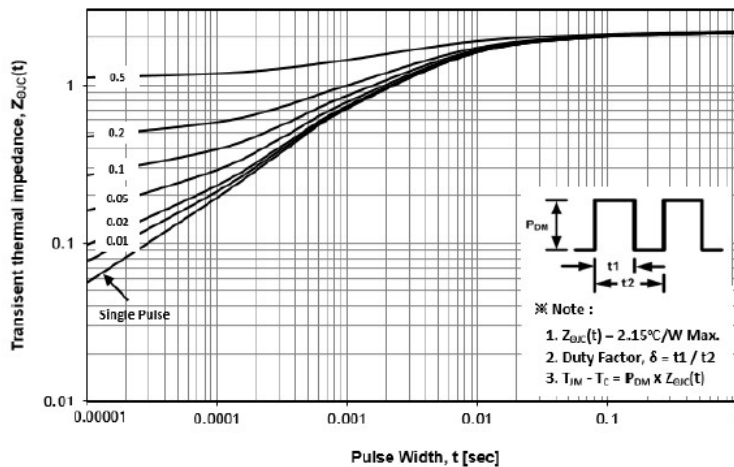

Fig. 12 Gate Charge Test Circuit & Waveform

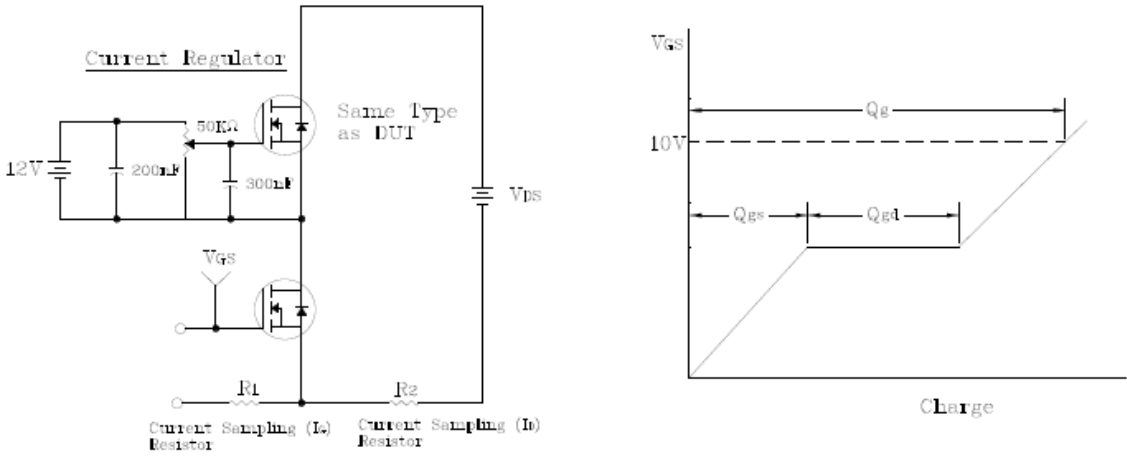

Fig. 13 Resistive Switching Test Circuit & Waveform

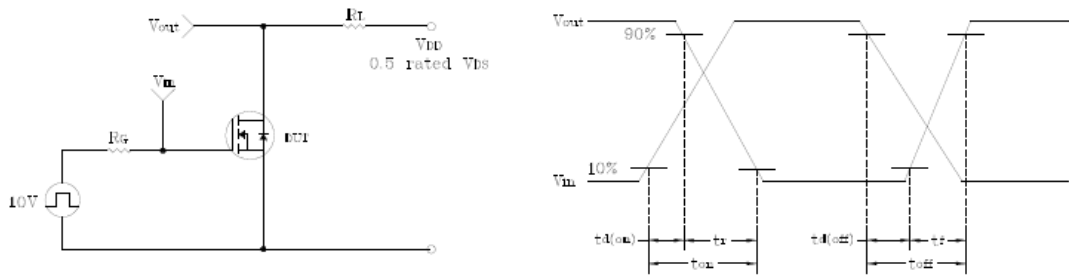

Fig. 14 EAS Test Circuit & Waveform

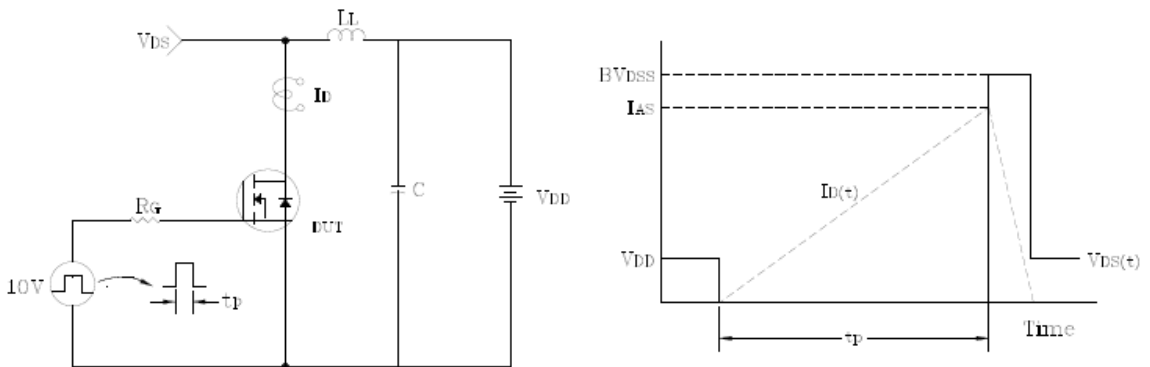

Fig. 15 Diode Reverse Recovery Time Test Circuit & Waveform

