

# SPL UL90AT08

## Metal Can® TO56

Nanostack Pulsed Laser Diode in TO-56 Package  
120 W Peak Power

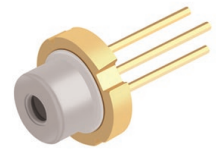

### Applications

- 3D Sensing
- CCTV Surveillance
- Electronic Equipment
- Industrial Automation (Machine Controls, Light Barriers, Vision Controls)
- LIDAR, Pre-Crash, ACC
- Measurement Levelling

### Features:

- Laser wavelength 905 nm
- Suited for short laser pulses from 1 to 100 ns
- Nanostack laser technology including 3 epitaxially stacked emitters
- Robust TO-can package for high volume applications
- Not released for automotive applications

### Ordering Information

Type	Peak output power typ. $P_{opt}$	Ordering Code
SPL UL90AT08	120 W	Q65112A2621

## Maximum Ratings

 $T_s = 25\text{ °C}$ 

Parameter	Symbol		Values
Operating temperature	$T_{op}$	min.	-40 °C
		max.	85 °C
Storage temperature	$T_{stg}$	min.	-40 °C
		max.	100 °C
Forward current	$I_F$	max.	40 A
Pulse width (FWHM)	$t_p$	max.	100 ns
Duty cycle	dc	max.	0.1 %
Reverse voltage <sup>1)</sup>	$V_R$	max.	3 V
Soldering temperature	$T_s$	max.	260 °C

## Characteristics

$I_F = 40 \text{ A}$ ;  $t_p = 100 \text{ ns}$ ;  $D = 0.01 \%$ ;  $T_s = 25 \text{ °C}$

Parameter	Symbol		Values
Number of emitters	n		3
Operating voltage	$V_{op}$	typ.	11 V
Peak wavelength	$\lambda_{peak}$	min. typ. max.	895 nm 905 nm 915 nm
Spectral bandwidth at 50% $I_{rel,max}$ (FWHM)	$\Delta\lambda$	typ.	7 nm
Peak output power	$P_{opt}$	typ.	125 W
Beam divergence (FWHM) parallel to pn-junction	$\Theta_{  }$	typ.	10 °
Beam divergence (FWHM) perpendicular to pn-junction	$\Theta_{\perp}$	typ.	25 °
Threshold current	$I_{th}$	typ.	0.6 A
Laser aperture (FWHM) parallel to pn-junction	$W_{  }$	typ.	220 $\mu\text{m}$
Laser aperture (FWHM) perpendicular to pn-junction	$W_{\perp}$	typ.	10 $\mu\text{m}$
Thermal resistance junction solder point real <sup>2)</sup>	$R_{thJS}$	typ.	25 K / W

## Relative Spectral Emission <sup>3), 4)</sup>

$I_{rel} = f(\lambda)$ ;  $I_F = 40\text{A}$ ;  $P_{opt} = 125\text{W}$ ;  $t_p = 100\text{ns}$ ;  $D = 0.01\%$

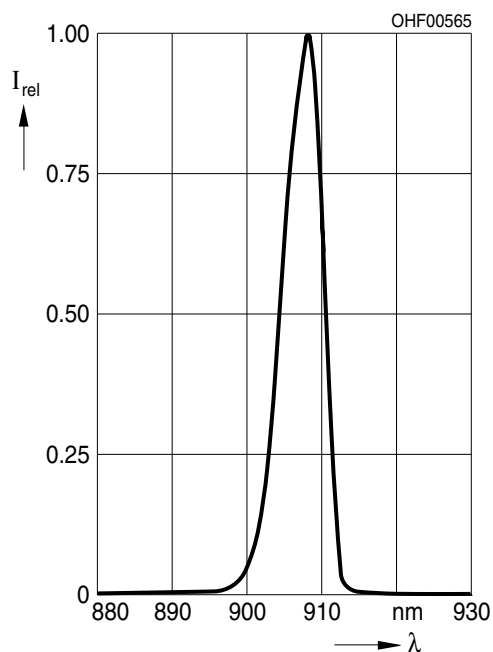

**Far-Field Distribution Perpendicular to pn-Junction** <sup>3), 4)</sup>

$$I_{\text{rel}} = f(\Theta_{\perp}); P_{\text{opt}} = 125\text{W}; t_p = 100\text{ns}; D = 0.01\%$$

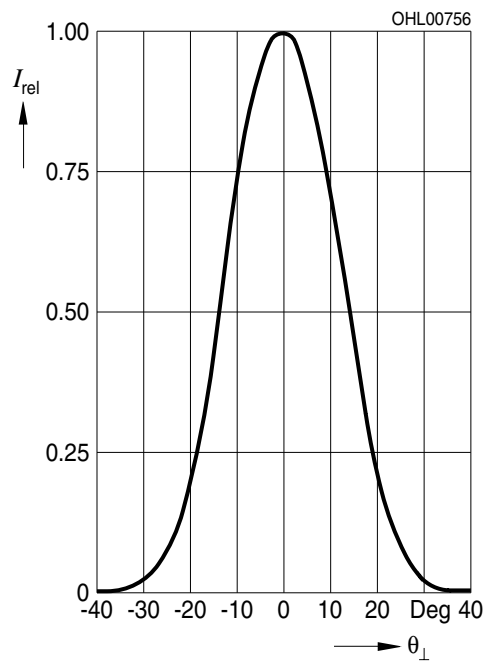
**Far-Field Distribution Parallel to pn-Junction** <sup>3), 4)</sup>

$$I_{\text{rel}} = f(\Theta_{\parallel}); P_{\text{opt}} = 125\text{W}; t_p = 100\text{ns}; D = 0.01\%$$

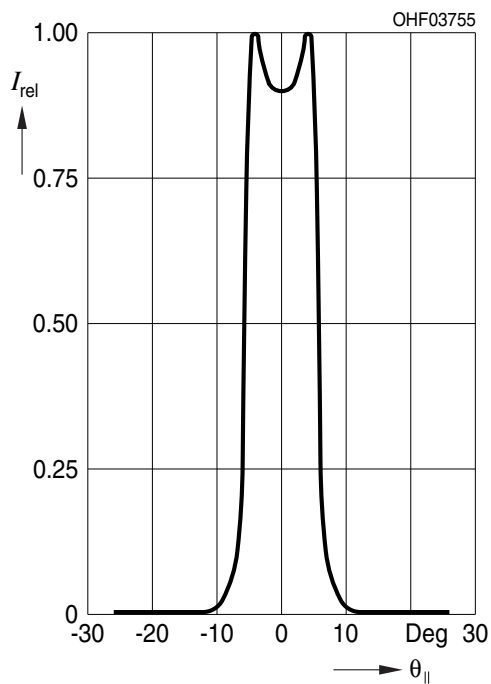

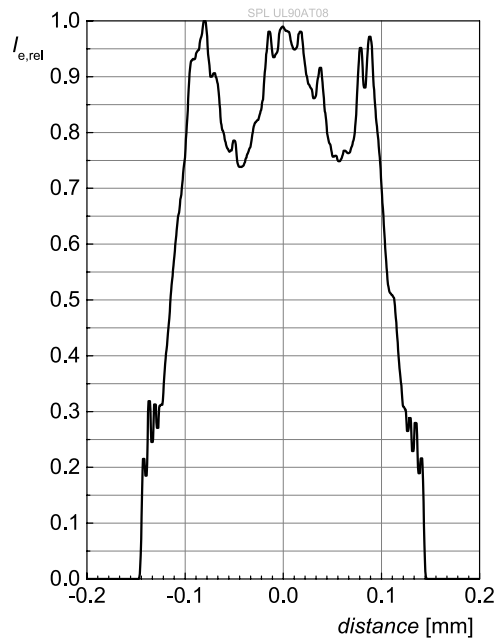
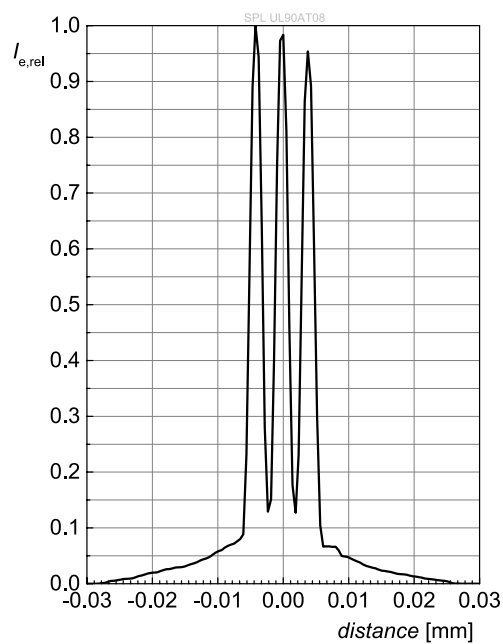
**Near-Field Distribution Parallel to pn-Junction** 3), 4) $I_{\text{rel}} = f(\Theta_{\parallel}); P_{\text{opt}} = 125\text{W}; t_p = 100\text{ns}; D = 0.01\%$ **Near-Field Distribution Perpendicular to pn-Junction** 3), 4) $I_{\text{rel}} = f(\Theta_{\perp}); P_{\text{opt}} = 125\text{W}; t_p = 100\text{ns}; D = 0.01\%$ 

### Optical Output Power <sup>3), 4)</sup>

$$P_{opt} = f(I_F)$$

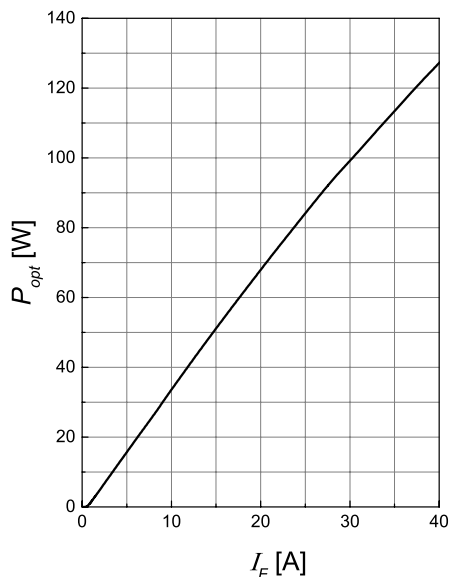

### Centroid Wavelength <sup>3)</sup>

$$\lambda_{centroid} = f(T_S); I_F = 40A; t_p = 100ns; D = 0.01\%$$

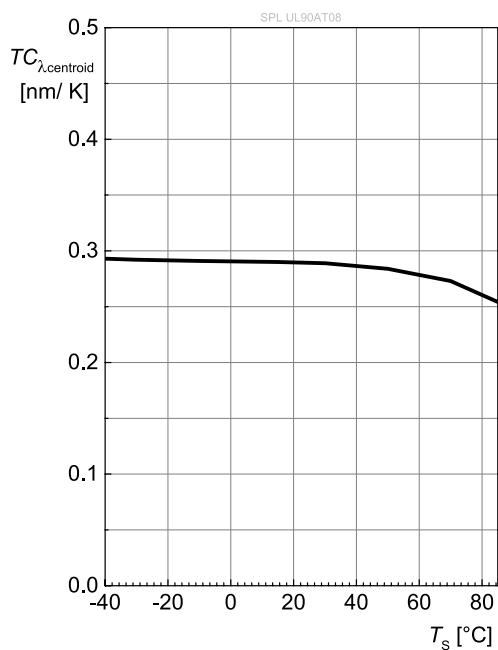

### Centroid Wavelength <sup>3)</sup>

$$\lambda_{centroid} = f(T_S); I_F = 40A; t_p = 100ns; D = 0.01\%$$

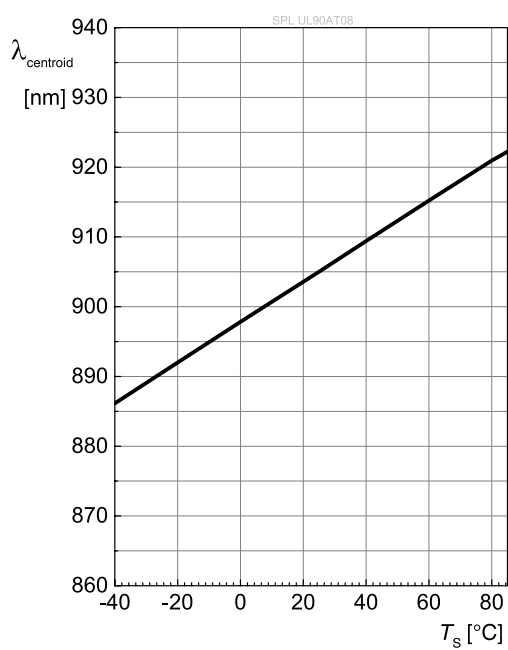

## Peak Output Power

$$P_{\text{opt}} = f(T_s); I_F = 40\text{A}; t_p = 100\text{ns}; D = 0.01\%$$

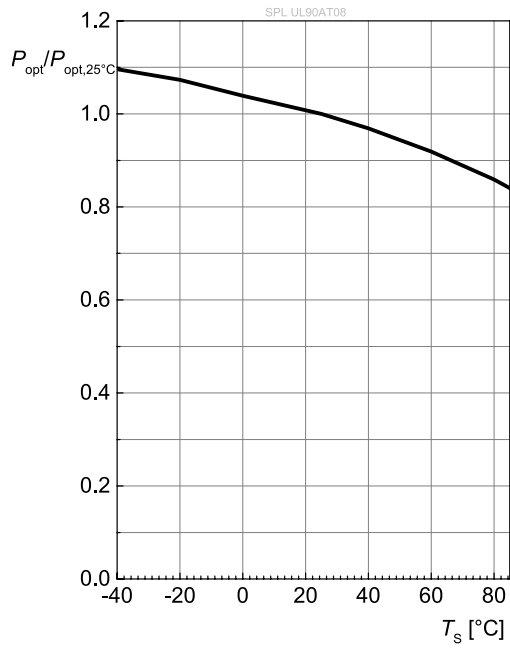

Dimensional Drawing <sup>5)</sup>

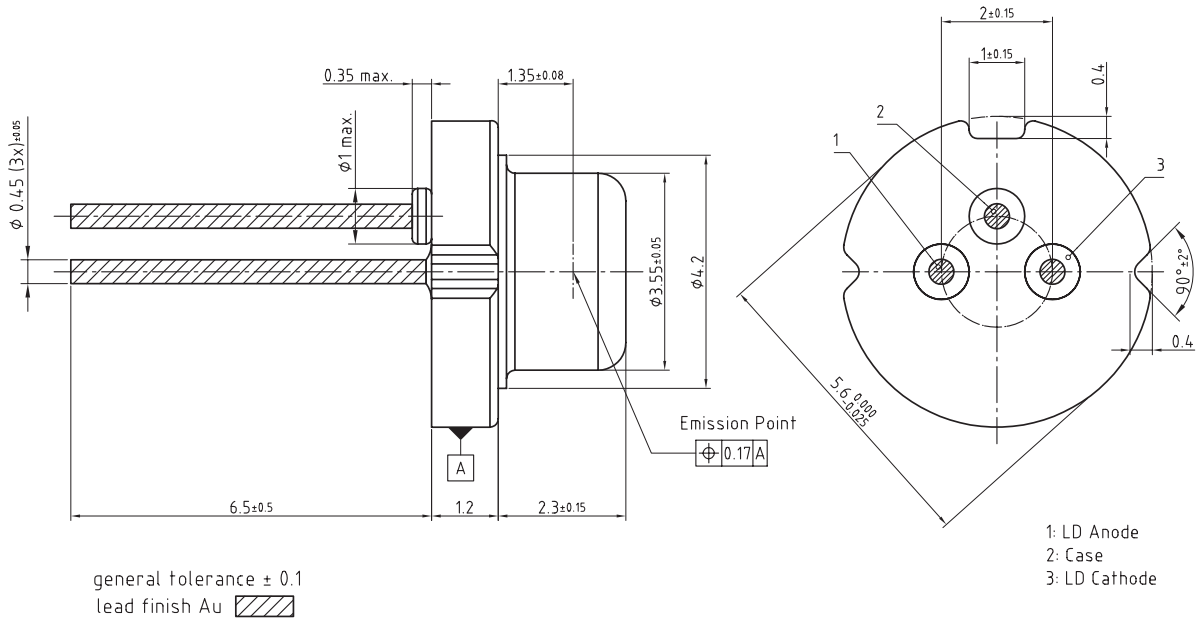

C63062-A4285-A1-01

Further Information

Approximate Weight: 312.0 mg



## Notes

Depending on the mode of operation, these devices emit highly concentrated visible and non visible light which can be hazardous to the human eye. Products which incorporate these devices have to follow the safety precautions given in IEC 60825-1.

Subcomponents of this device contain, in addition to other substances, metal filled materials including silver. Metal filled materials can be affected by environments that contain traces of aggressive substances. Therefore, we recommend that customers minimize device exposure to aggressive substances during storage, production, and use. Devices that showed visible discoloration when tested using the described tests above did show no performance deviations within failure limits during the stated test duration. Respective failure limits are described in the IEC60810.

For further application related information please visit [www.osram-os.com/appnotes](http://www.osram-os.com/appnotes)

Products which incorporate these devices have to follow the safety precautions given in IEC 60825-1 and IEC 62471.

## Disclaimer

### Attention please!

The information describes the type of component and shall not be considered as assured characteristics. Terms of delivery and rights to change design reserved. Due to technical requirements components may contain dangerous substances.

For information on the types in question please contact our Sales Organization.

If printed or downloaded, please find the latest version on the OSRAM OS website.

### Packing

Please use the recycling operators known to you. We can also help you – get in touch with your nearest sales office.

By agreement we will take packing material back, if it is sorted. You must bear the costs of transport. For packing material that is returned to us unsorted or which we are not obliged to accept, we shall have to invoice you for any costs incurred.

### Product safety and functional safety devices/applications or medical devices/applications

OSRAM OS components are not developed, constructed or tested for the application as safety relevant component or for the application in medical devices.

OSRAM OS products are not qualified at module and system level for such application.

An entire (100%) testing shall be performed after assembly of the OSRAM OS product to the final product. OSRAM OS product are not qualified at module and system level for such application. Customer is fully responsible and accountable for detection capability in case of sudden changes in electro-optical characteristics at component level.

In case Buyer – or Customer supplied by Buyer– considers using OSRAM OS components in product safety and functional safety devices/applications or medical devices/applications, Buyer and/or Customer has to inform the local sales partner of OSRAM OS immediately and OSRAM OS and Buyer and /or Customer will analyze and coordinate the customer-specific request between OSRAM OS and Buyer and/or Customer.

The user of the application needs to be aware that the skin must not be exposed to the laser radiation and it can be hazardous to the human eye, depending on the mode of operation. The application shall only be operated within the range approved in the specifications released by OSRAM OS.

OSRAM OS refuses any and all kind of liability in case these instructions are not followed.

## Glossary

- 1) **Reverse Operation:** Reverse Operation of 10 hours is permissible in total. Continuous reverse operation is not allowed.
- 2) **Thermal resistance:** junction - soldering point, of the device only, mounted on an ideal heatsink (e.g. metal block)
- 3) **Typical Values:** Due to the special conditions of the manufacturing processes of semiconductor devices, the typical data or calculated correlations of technical parameters can only reflect statistical figures. These do not necessarily correspond to the actual parameters of each single product, which could differ from the typical data and calculated correlations or the typical characteristic line. If requested, e.g. because of technical improvements, these typ. data will be changed without any further notice.
- 4) **Testing temperature:** TA = 25°C (unless otherwise specified)
- 5) **Tolerance of Measure:** Unless otherwise noted in drawing, tolerances are specified with  $\pm 0.1$  and dimensions are specified in mm.

---

## Revision History

Version	Date	Change
1.0	2019-04-08	Initial Version
1.2	2019-05-13	Characteristics Electro - Optical Characteristics (Diagrams)
1.3	2019-07-03	Characteristics

Published by OSRAM Opto Semiconductors GmbH EU RoHS and China RoHS compliant product  
Leibnizstraße 4, D-93055 Regensburg  
www.osram-os.com © All Rights Reserved.



此产品符合欧盟 RoHS 指令的要求；  
按照中国的相关法规和标准，不含有毒有害物质或元素。