



概述

EL357是一块小外形的贴片光电耦合器件，适合表面贴装生产。EC357是由一个砷化镓发光二极管和一个光电晶体管组成的光电耦合器，它的体积比DIP小，适用于高密度表面贴装应用，如可编程控制器等。

特性

- 电流转换比 (CTR)范围: 80~600% ($I_F=5\text{mA}$, $V_{CE}=5\text{V}$)
- 输入-输出隔离电压($V_{iso}=3750\text{Vrms}$)
- 集电极-发射极击穿电压 $BV_{CEO}\geq 80\text{V}$
- 工作温度: $-55\sim 110^\circ\text{C}$

应用参数

- 开关电源，智能电表
- 工业控制，测量仪器
- 办公设备，比如复印机
- 家用电器，比如空调、风扇、热水器等

结构原理图和封装

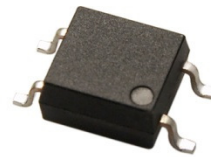
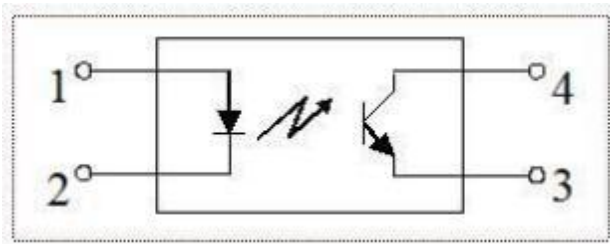

极限参数($T_a=25^\circ\text{C}$)

参数		符号	额定值	单位
输入	正向电流	I_F	50	mA
	正向脉冲电流	I_{FP}	1	A
	反向电压	V_R	6	V
	功耗	P	70	mW
	结温	T_j	125	$^\circ\text{C}$
输出	集电极功耗	P_C	150	mW
	集电极电流	I_C	50	mA
	集电极-发射极电压	V_{CEO}	80	V
	发射极-集电极电压	V_{ECO}	7	V
	结温	T_j	125	$^\circ\text{C}$
总功耗		P_{tot}	200	mW
隔离电压		V_{iso}	5000	V_{rms}
工作温度		T_{opr}	$-55\sim 110$	$^\circ\text{C}$
储存温度		T_{stg}	$-55\sim 125$	$^\circ\text{C}$
焊接温度		T_{sol}	260	$^\circ\text{C}$



光电特性(Ta=25 ° C)

Parameter		Symbol	Condition	Min.	Typ.	Max.	Unit
输入	正向电压	V_F	$I_F=20\text{mA}$		1.2	1.4	V
	反向电流	I_R	$V_R=5\text{V}$	-	-	10	μA
	终端电容	C_t	$V=0, f=1\text{kHz}$	-	30	250	pF
输出	集电极暗电流	I_{CEO}	$V_{CE}=70\text{V}$	-	-	100	nA
	集电极-发射极击穿电压	BV_{CEO}	$I_C=0.1\text{mA}, I_F=0$	80	-	-	V
	发射极-集电极击穿电压	BV_{ECO}	$I_E=0.1\text{mA}, I_F=0$	7	-	-	V
传输特性	电流转换比	CTR	$I_F=5\text{mA}, V_{CE}=5\text{V}$	50	-	400	%
	集电极-发射极饱和压降	$V_{CE(sat)}$	$I_F=20\text{mA}, I_C=1\text{mA}$	-	0.1	0.2	V
	隔离电阻	R_{ISO}	DC1000V, 40~60% R.H.	1×10^{11}	-	-	Ω
	隔离电容	C_f	$V=0, f=1\text{MHz}$	-	0.6	1.0	pF
	集电极-发射极电容	C_{CE}	$V=0, f=1\text{MHz}$		10		pF
	截止频率	F_c	$V_{CE}=5\text{V}, I_C=2\text{mA},$ $R_L=100\Omega, -3\text{dB}$	-	80	-	kHz
开关时间	上升时间	T_r	$V_{CE}=10\text{V}, I_C=2\text{mA},$ $R_L=100\Omega$	-	4	18	μs
	下降时间	T_f		-	3	18	μs

* CTR= $I_C/I_F \times 100\%$

CTR分级表

型号	分级标准	I_C (mA)		对应CTR (%)	
		$I_F = 5\text{mA}, V_{CE} = 5\text{V}, T_a = 25^\circ\text{C}$		$I_F = 5\text{mA}, V_{CE} = 5\text{V}, T_a = 25^\circ\text{C}$	
		Min	Max	Min	Max
EL357	Blank	2.5	30.0	50	600
	A	4.0	8.0	80	160
	B	6.5	13.0	130	260
	C	10.0	20.0	200	400
	D	15.0	30.0	300	600
	A or B	4.0	13.0	80	160
	B or C	6.5	20.0	130	400
	C or D	10.0	30.0	200	600
	A,B or C	4.0	20.0	80	400
	B,C or D	6.5	30.0	130	600
	A,B,C or D	4.0	30.0	80	600



测试电路

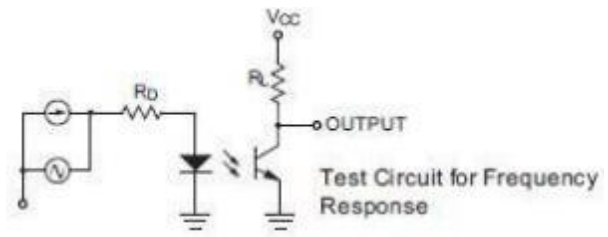
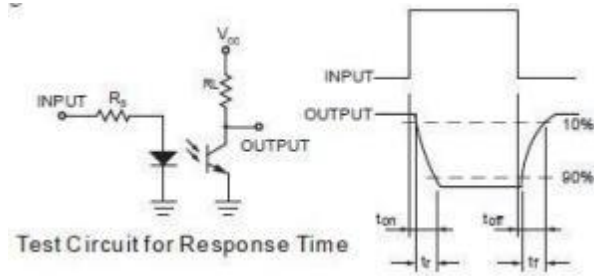

典型特性

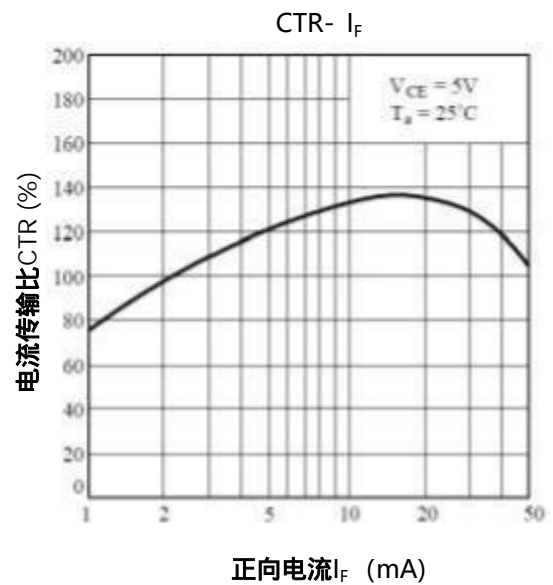
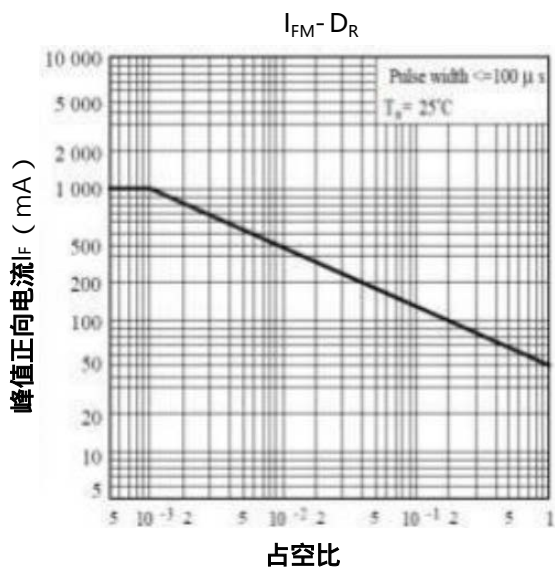
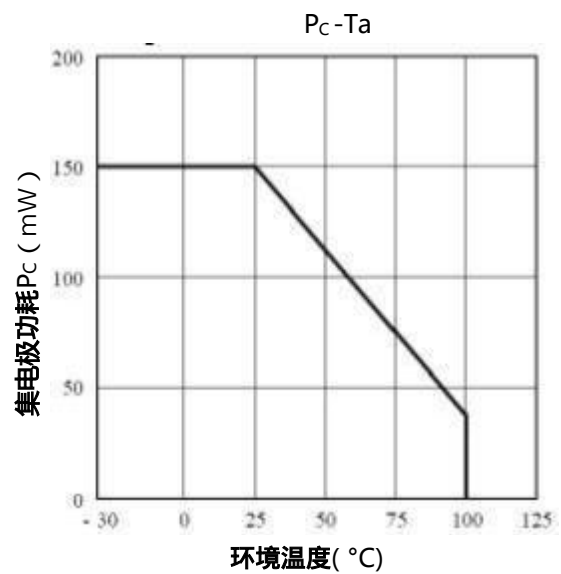
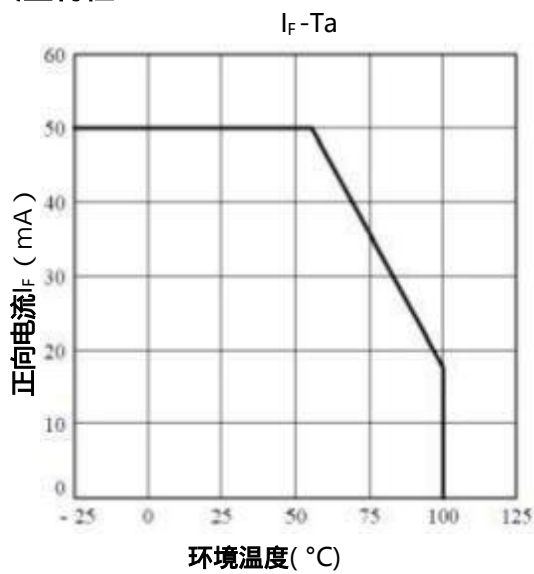

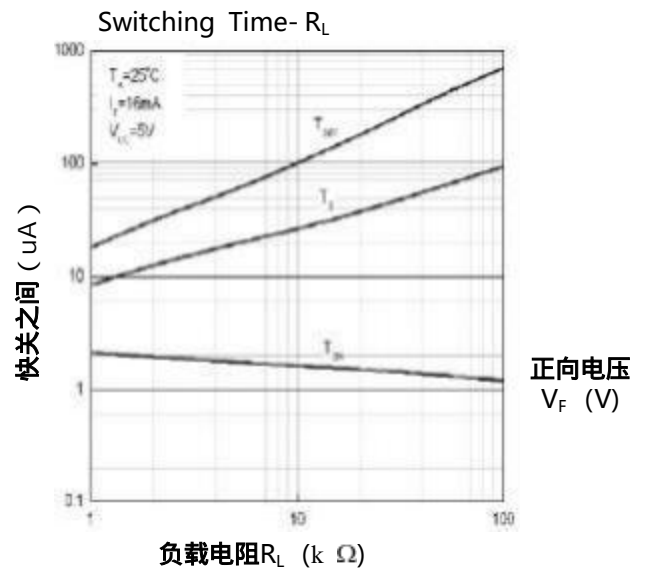
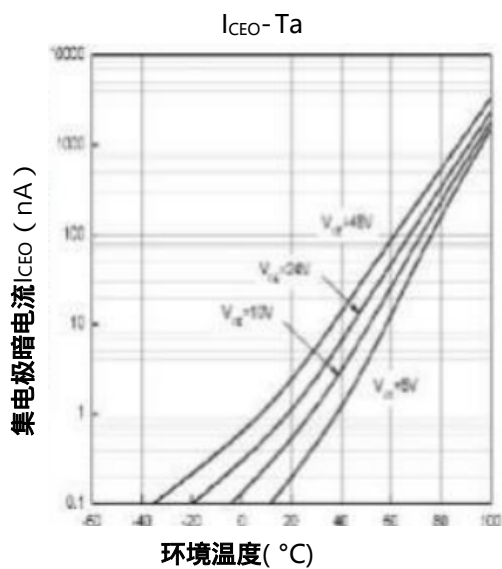
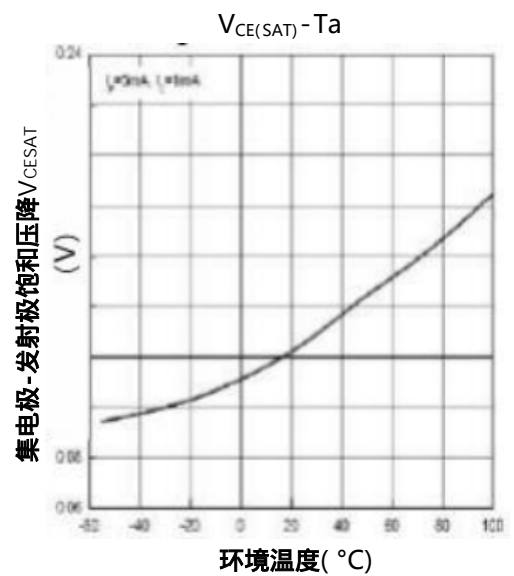
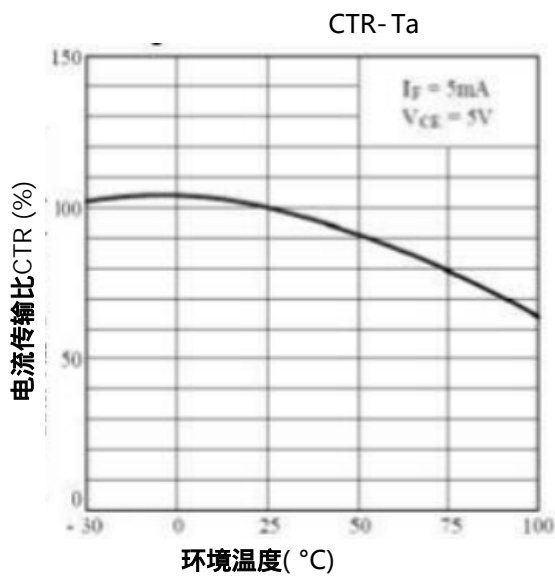
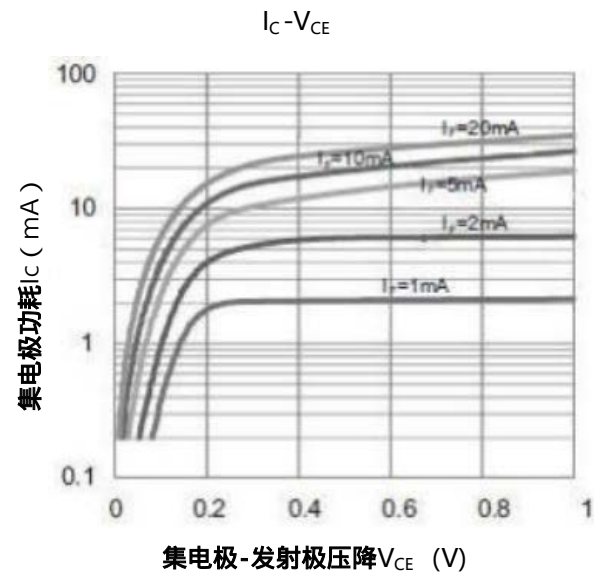
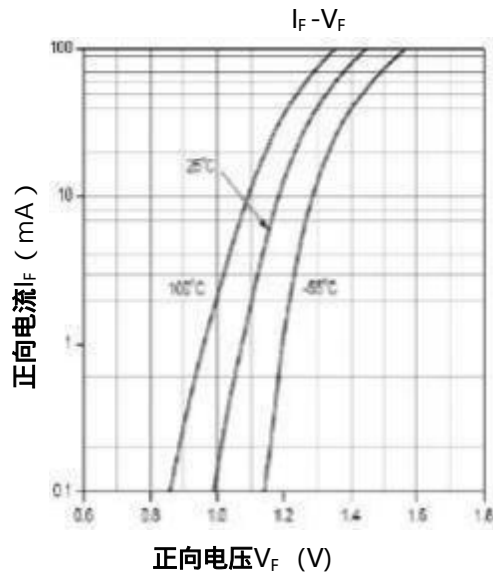

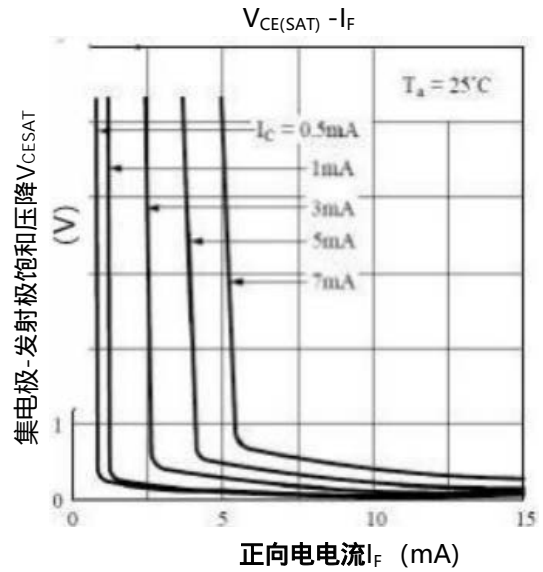
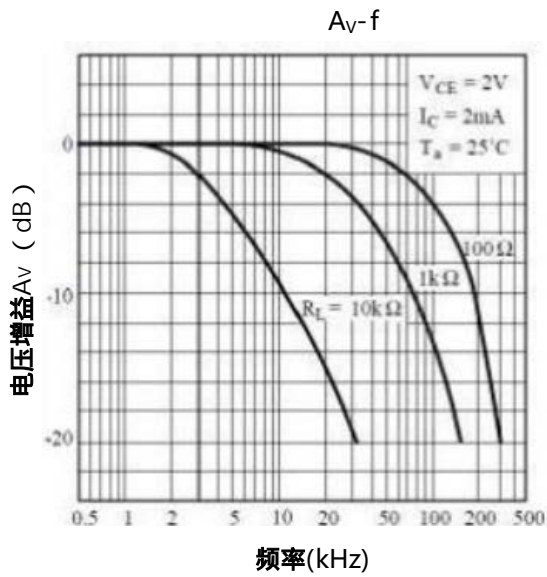

回流焊温度曲线图

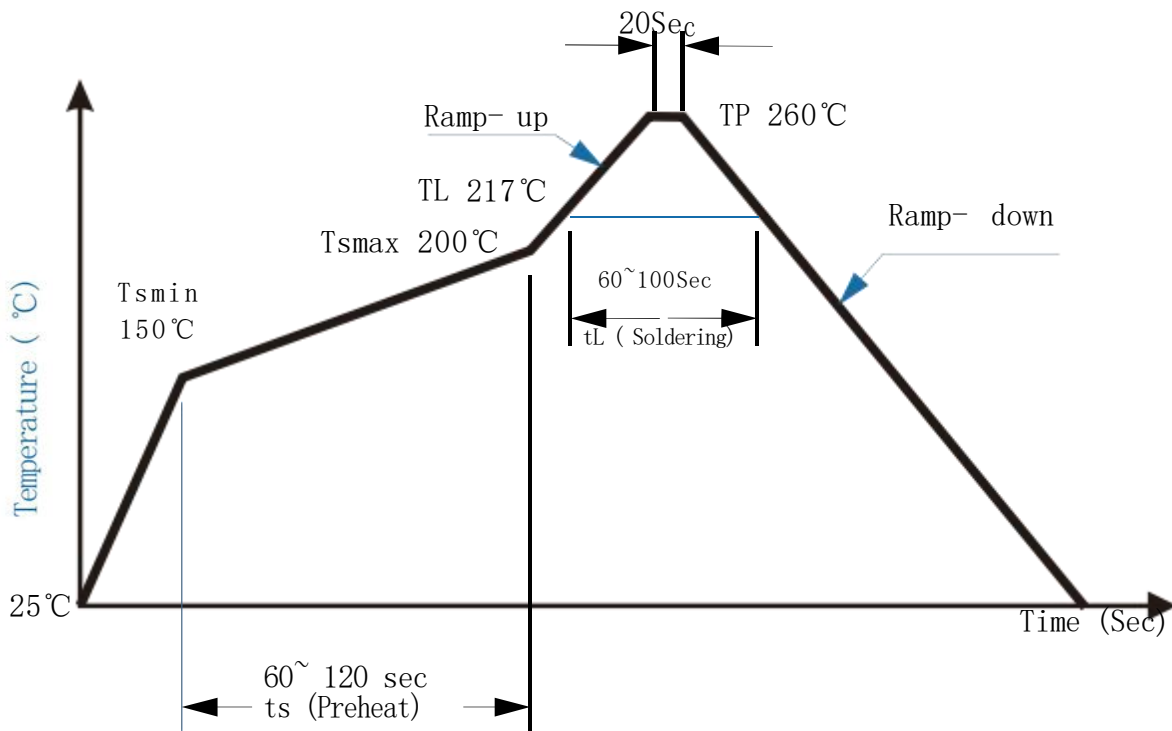



外形尺寸 (单位: mm)

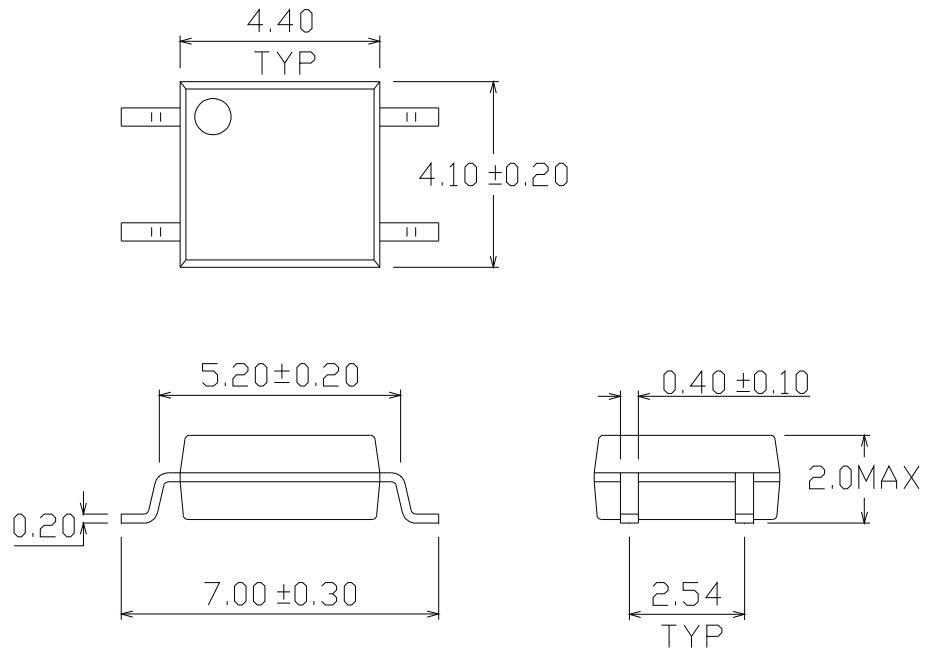



Attention

- Any and all HUA XUANYANG ELECTRONICS products described or contained herein do not have specifications that can handle applications that require extremely high levels of reliability, such as life-support systems, aircraft's control systems, or other applications whose failure can be reasonably expected to result in serious physical and/or material damage. Consult with your HUA XUANYANG ELECTRONICS representative nearest you before using any HUA XUANYANG ELECTRONICS products described or contained herein in such applications.
- HUA XUANYANG ELECTRONICS assumes no responsibility for equipment failures that result from using products at values that exceed, even momentarily, rated values (such as maximum ratings, operating condition ranges, or other parameters) listed in products specifications of any and all HUA XUANYANG ELECTRONICS products described or contained herein.
- Specifications of any and all HUA XUANYANG ELECTRONICS products described or contained herein stipulate the performance, characteristics, and functions of the described products in the independent state, and are not guarantees of the performance, characteristics, and functions of the described products as mounted in the customer's products or equipment. To verify symptoms and states that cannot be evaluated in an independent device, the customer should always evaluate and test devices mounted in the customer's products or equipment.
- HUA XUANYANG ELECTRONICS CO.,LTD. strives to supply high-quality high-reliability products. However, any and all semiconductor products fail with some probability. It is possible that these probabilistic failures could give rise to accidents or events that could endanger human lives, that could give rise to smoke or fire, or that could cause damage to other property. When designing equipment, adopt safety measures so that these kinds of accidents or events cannot occur. Such measures include but are not limited to protective circuits and error prevention circuits for safe design, redundant design, and structural design.
- In the event that any or all HUA XUANYANG ELECTRONICS products(including technical data, services) described or contained herein are controlled under any of applicable local export control laws and regulations, such products must not be exported without obtaining the export license from the authorities concerned in accordance with the above law.
- No part of this publication may be reproduced or transmitted in any form or by any means, electronic or mechanical, including photocopying and recording, or any information storage or retrieval system, or otherwise, without the prior written permission of HUA XUANYANG ELECTRONICS CO.,LTD.
- Information (including circuit diagrams and circuit parameters) herein is for example only ; it is not guaranteed for volume production. HUA XUANYANG ELECTRONICS believes information herein is accurate and reliable, but no guarantees are made or implied regarding its use or any infringements of intellectual property rights or other rights of third parties.
- Any and all information described or contained herein are subject to change without notice due to product/technology improvement, etc. When designing equipment, refer to the "Delivery Specification" for the HUA XUANYANG ELECTRONICS product that you intend to use.