

PMx Gateway Datasheet



The Sure Cross® wireless system is a radio frequency network with integrated I/O that operates in most environments to eliminate the need for wiring runs.

PM2 Gateway Models

Models	Frequency	Environmental Rating	I/O
DX80G9M6S-PM2	900 MHz ISM Band	IP67, NEMA 6	Inputs: Four selectable discrete, two 0–20 mA Outputs: Four sourcing discrete, two 0–20 mA analog I/O is automatically mapped to the PM2 Node using the Gateway's menu system
DX80G2M6S-PM2	2.4 GHz ISM Band		



DX80...C (IP20; NEMA 1) models are also available. To order this model with an IP20 housing, add a C to the end of the model number: For example, DX80G9M6S-PM2C.

Configuration Instructions

Configure the DIP Switches

Before changing DIP switch positions, disconnect the power⁽¹⁾. Any changes made to the DIP switches are not recognized until after power is cycled to the device. For parameters not set using the DIP switches, use the configuration software to make configuration changes. For parameters set using the DIP switches, the DIP switch positions override any changes made using the configuration software.

Access the Internal DIP Switches

Follow these steps to access the internal DIP switches.

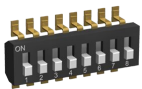

1. Unscrew the four screws that mount the cover to the bottom housing.
2. Remove the cover from the housing without damaging the ribbon cable or the pins the cable plugs into.
3. Gently unplug the ribbon cable from the board mounted into the bottom housing. Skip this step if there is no ribbon cable (integrated battery models) or the ribbon cable is glued down (for C housing models).
4. Remove the black cover plate from the bottom of the device's cover.
The DIP switches are located behind the rotary dials.
5. Make the necessary changes to the DIP switches.
6. Place the black cover plate back into position and gently push into place.
7. If necessary, plug the ribbon cable in after verifying that the blocked hole lines up with the missing pin.
8. Mount the cover back onto the housing.

⁽¹⁾ For devices powered by batteries integrated into the housing, triple-click button 2, then double-click button 2 to reset the device without removing the battery.

DIP Switch Settings

Device Settings	Switches					
	1	2	3	4	5	6 ⁽¹⁾
900 MHz transmit power level: 1 Watt (30 dBm)	OFF*					
900 MHz transmit power level: 250 mW (24 dBm), DX80 compatibility mode	ON					
Modbus or UCT configured (overrides DIP switches 3-8)		OFF*				
DIP switch configured		ON				
Inputs sourcing (PNP)			OFF*			
Inputs sinking (NPN)			ON			
Link loss output: zero				OFF*	OFF*	
Link loss output: one				OFF	ON	
Link loss output: hold last state				ON	OFF	
Link loss output: user configuration				ON	ON	
0 to 20 mA scale						OFF*
4 to 20 mA scale						ON

* Default configuration

Analog Input and Output Scale

Use the DIP switch to select which current scale to use for all the device's analog inputs and outputs: 0 to 20 mA or 4 to 20 mA. When using a 4-20 mA sensor with a 0-20 mA input, the sensor uses the 4-20 mA section of the total range. Using a 4-20 mA with a 0-20 mA input allows you to determine when you have an error condition with the sensor. A normal input reading between 4 and 20 mA indicates a functioning sensor whereas a value below 4 mA indicates an error condition, such as a broken wire or loose connection. This DIP switch is used only on the 0 to 20 mA models, not the 0 to 10V models.

Discrete Input Type

Select the type of discrete input sensors to use with this device: sourcing (PNP) sensors or sinking (NPN) sensors.

Link Loss Outputs

The Sure Cross® wireless devices use a deterministic radio link time-out method to address RF link interruption or failure. When a radio link fails, all pertinent wired outputs are set to defined states until the link is recovered, ensuring that disruptions in the communications link result in predictable system behavior.

Following a radio link time-out, all outputs linked to the Node in question are set to de-energize (discrete outputs to zero, analog outputs to 0 mA or 4 mA), energize (discrete outputs to one, analog outputs to 20 mA), or hold the last stable state/value. Use the DIP switches to select the link loss output state.

Modbus/Software or DIP Switch Configured

In Modbus/Software Configured mode, use the DX80 Performance Configuration Software or a Modbus command to change the device parameters. DIP switch positions 3 through 8 are ignored. In DIP Switch Configured mode, use the DIP switches to configure the parameters listed in the table.

Transmit Power Levels

The 900 MHz radios transmit at 1 Watt (30 dBm) or 250 mW (24 dBm). The 250 mW mode reduces the radio's range but improves the battery life in short-range applications. For 2.4 GHz models, this DIP switch is disabled. The transmit power for 2.4 GHz is fixed at about 65 mW EIRP (18 dBm).

Wire Your Sure Cross® Device

Use the following wiring diagrams to first wire the sensors and then apply power to the Sure Cross devices.

⁽¹⁾ Not used when configured for 0-10 V I/O.

Terminal Blocks (PM2 and PM2C Models)

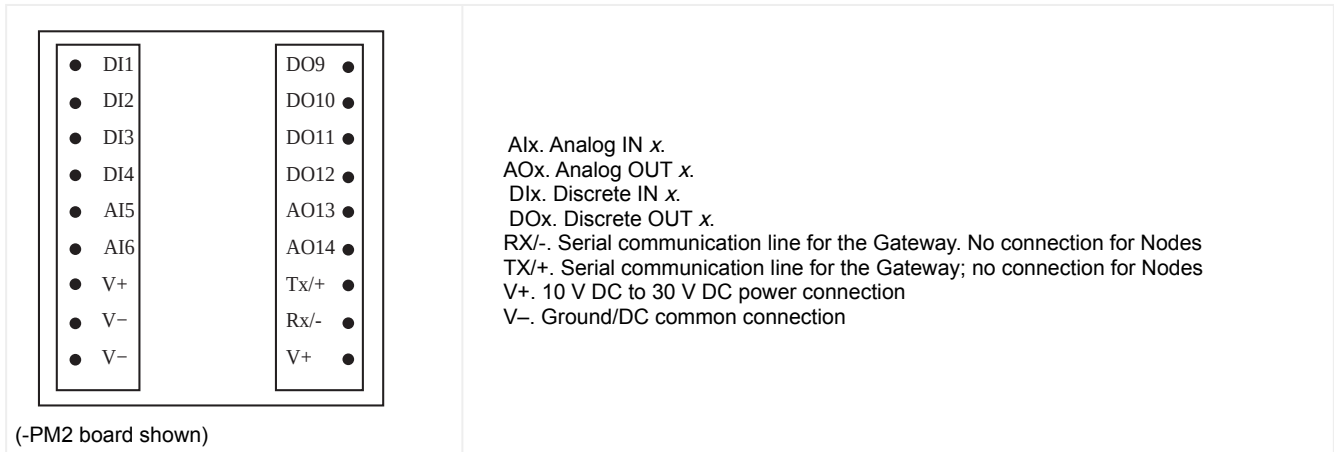

Connecting power to the communication pins will cause permanent damage. For the DX8x..C models, PWR in the wiring diagram refers to V+ on the wiring board and GND in the wiring diagram refers to V- on the wiring board.

Do not exceed analog input ratings for analog inputs. Only connect sensor outputs to analog inputs.

To power the sensor using the switch power output (SPx), replace the PWR with SPx in these wiring diagrams.

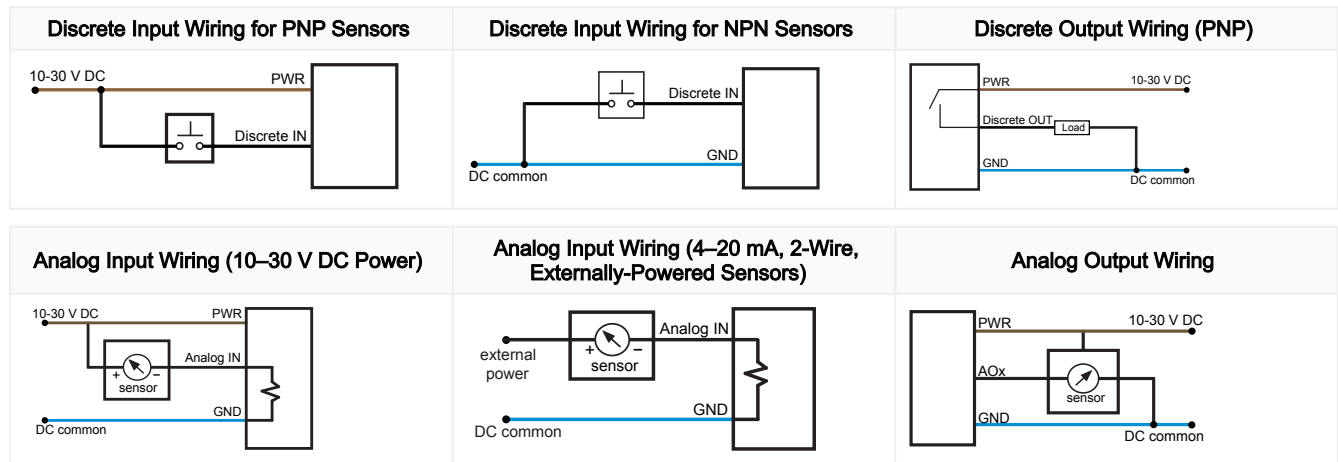

Bind the DX80 Nodes to the DX80 Gateway and Assign the Node Address

Before beginning the binding procedure, apply power to all the devices. Separate radios by 2 meters when running the binding procedure. Put only one Gateway into binding at a time to prevent binding to the wrong Gateway.

1. Enter binding mode on the Gateway.
 - For housed DX80 Gateways, triple-click the right-hand button. LEDs alternately flash red.
 - For board level DX80 Gateways, triple-click the binding button. LED flashes green and red.
2. Use both of the Node's rotary dials to assign the Node Address defined in the Gateway's datasheet.

The left rotary dial represents the tens digit (0 through 4) and the right dial represents the ones digit (0 through 9) of the Node Address.
3. To enter binding mode on the Node, triple-click button 2.

The Node enters binding mode and locates the Gateway in binding mode. The red LEDs flash alternately. The Node automatically exits binding mode. After the Node is bound, the LEDs are both solid red for a few seconds. The Node cycles its power, then enters Run mode. For the pre-mapped kits (PMx), the Node's rotary dials must be set based on the mapping defined by the Gateway. For more information, refer to the mapping tables in the MAPIO Menu section of the Gateway's datasheet.
4. Label the Node with the assigned address for future references.
5. Repeat steps 2 through 4 for all Nodes that need to communicate to this Gateway.
6. Exit binding mode on the Gateway by single-clicking either button 1 or button 2.

For Gateways with single line LCDs, after binding your Nodes to the Gateway, make note of the binding code displayed under the Gateway's *DVCFG menu, XADR submenu on the LCD. Knowing the binding code prevents having to re-bind all Nodes if your Gateway is ever replaced.

LED Behavior for the Gateways and Nodes

Verify all devices are communicating properly. Nodes do not sample inputs until they are communicating with the Gateway. The radios and antennas must be a minimum distance apart to function properly. Recommended minimum distances are:

- 900 MHz 150 mW and 250 mW radios: 6 feet
- 900 MHz 1 Watt radios: 15 feet
- 2.4 GHz 65 mW radios: 1 foot

LED behavior

Devices with Two LEDs		Devices with One LED	Gateway Status	Node Status
LED 1	LED 2			
Green		Green	Power is on	N/A
Flashing green			N/A	Radio link is okay
Flashing red	Flashing red	Flashing red	Device error	Device error
	Flashing amber	Green and red flash (amber) together	Modbus communication active	N/A
	Flashing red	Flashing red	Modbus communication error	No radio link (flashes once every 3 s)
Flashing red (alternately)	Flashing red (alternately)	Green and red flash alternately	Device is in binding mode	Device is in binding mode
		Red	Gateway is trying to conduct a Site Survey with a Node that doesn't exist	
		Green and red solid (amber) together	No radio communication detected	
Red (4 s)	Red (4 s)	Green/red solid (amber) for 4 seconds, then flash 4 times		Binding mode is complete

For Gateway systems, the Modbus communication LEDs refer to the communication between the Gateway and its host system (if applicable). For Gateway and Ethernet Bridge systems, active Modbus communication refers to the communication between the Gateway and the Ethernet Bridge. For GatewayPro systems, the Modbus communication LEDs refer to the communication internal to the GatewayPro.

Conducting a Site Survey (Gateway and Nodes)

A Site Survey, also known as a Radio Signal Strength Indication (RSSI), analyzes the radio communications link between the Gateway and any Node within the network by analyzing the radio signal strength of received data packets and reporting the number of missed packets that required a retry.

Perform a Site Survey before permanently installing the radio network to ensure reliable communication. Activate Site Survey mode from either the Gateway buttons or the Gateway Modbus holding register 15. Only the Gateway can initiate a Site Survey, and the Site Survey analyzes the radio communications link with one Node at a time.

SITE (Site Survey) Menu

The **SITE** menu displays the results of a Site Survey conducted with this Gateway.

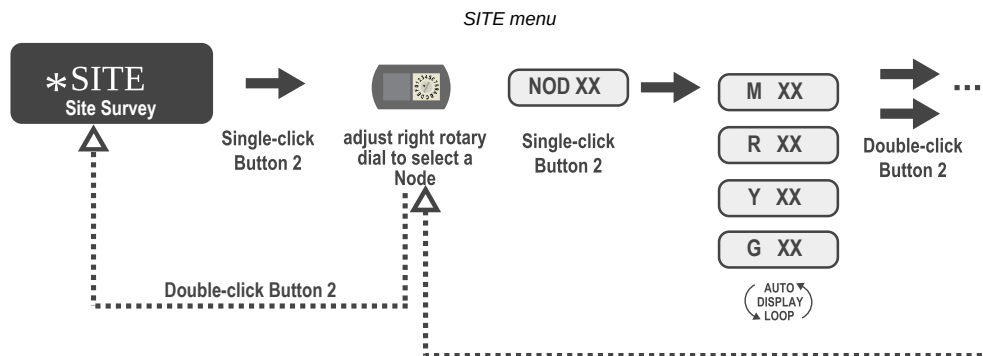

The **SITE** menu displays the device number of the Node the Site Survey was conducted with as well as the missed, green, yellow, and red received packet count. The **SITE** menu is only available on the Gateways. To access the **SITE** menu, single-click button 1 to scroll across the menu levels until reaching the Site Survey (**SITE**) menu.

See ["Conduct a Site Survey Using the Menu System"](#) on page 5.

See ["Interpreting the Site Survey Results"](#) on page 5.

Conduct a Site Survey Using the Menu System



Initiate a Site Survey using the Gateway's buttons and menu system.

1. Remove the Gateway's rotary dial access cover.
2. Set the Gateway's rotary dials to the desired Node number.
For example, to check the status of Node 1, set the Gateway's left rotary dial to 0 and the right rotary dial to 1. To check the status of Node 32, set the Gateway's left rotary dial to 3 and the right rotary dial to 2.
The Gateway is now enabled to read the status of the selected Node. The display scrolls through the Node's I/O status.
3. Single-click button 1 to scroll across the menu levels until reaching the Site Survey (SITE) menu.
4. Single-click button 2 to enter the Site Survey menu.
5. Single-click button 2 to begin conducting a Site Survey with the Node selected in step 2.
The Gateway analyzes the quality of the signal from the selected Node by counting the number of data packets it receives from the Node.
6. Examine reception readings (M, R, Y, G) of the Gateway at various locations.
Site survey results display as a percentage. M represents the percent of missed packets while R, Y, and G represent the percent of received packets at a given signal strength.
M = Percent of missed packets; R = RED marginal signal; Y = YELLOW good signal; G = GREEN excellent signal. Record the results if you need troubleshooting assistance from the factory.
7. Change the Gateway's rotary dials to conduct a Site Survey with another Node and repeat steps 2 through 6.
8. To end the Site Survey, double-click the Gateway's button 2.
9. Change the Gateway's rotary dials back to 0.
The LCD displays the device readings for the Gateway.
10. Double-click button 2 to move back to the top level menu.
11. Single-click button 1 to return to RUN mode.
12. Install the rotary dial access cover, referring to the Installation section of the manual to create an IP67 seal.

Interpreting the Site Survey Results

Site Survey results are listed as a percentage of data packets received and indicate the signal strength of the received signal.

Site survey results

	Result	Description
	Green	Packets received at a strong signal strength. A strong signal strength is greater than -90 dBm at the receiver.
	Yellow	Packets received at a good signal strength. A good signal is between -90 and -100 dBm at the receiver.
	Red	Packets received at a weak signal strength. A weak signal is less than -100 dBm at the receiver.
	Missed	Packets not received on the first transmission and requiring a retry.

Judging if the reliability of a network's signal meets the needs of the application is not just a matter of green, yellow, and red packets received. In normal operating mode, when data packets are not received, the transmitter re-sends the packet until all data is received.

For slow monitoring applications such as a tank farm, where data is required in terms of seconds or minutes, receiving most of the data in the 'red' range, indicating a weak but reliable signal, transmits enough data for accurate monitoring. Nodes positioned near the outside range of the radio signal may have 90% of the data packets received in the red zone, again indicating a weak, but reliable signal.

We recommend keeping the missed packets average to less than 25%. When the network misses more than 25% of the data packets, the signal is usually too unreliable or obstacles may be interfering with the signal. When Site Survey reports the missed packets are 25% or higher, improve the radio system performance by:

- **Mounting the network's antennas higher** to clear obstacles in the area and improve the line of sight between Sure Cross® devices
- **Using higher gain antennas** to focus the energy of the radio signal in a specific direction and extend the signal's range
- **Adding data radios to the network** to extend the range of a radio network. For more information on data radios, please refer to Banner's white paper on range extension on www.bannerengineering.com/wireless.

MAPIO Menu for the PM2 Gateway

The PM2 Gateway and Node use the LCD menu system to automatically map I/O. The Node's rotary dials need to be set properly for the I/O mapping to work.

The first map in the list is the factory default setting. In addition to the MAPIO menu, an entry was added to the bottom of the DVCFG menu to display the currently selected I/O map.

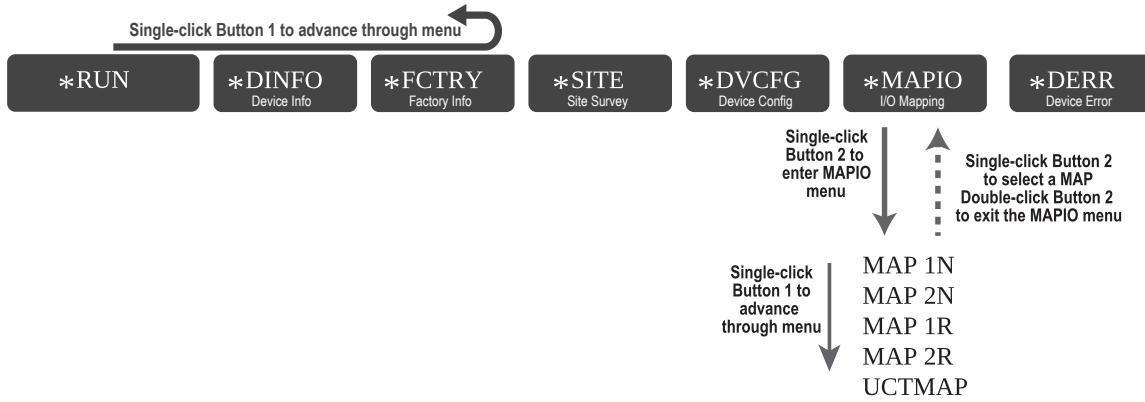

MAP 1N

MAP 1N maps the I/O between the PM2 Gateway and one PM2 Node. Verify Node 1's rotary dials are set to 01.

Gateway	Maps to	Node 1
Discrete IN 1	→	Discrete OUT 9
Discrete IN 2	→	Discrete OUT 10
Discrete IN 3	→	Discrete OUT 11
Discrete IN 4	→	Discrete OUT 12
Analog IN 5	→	Analog OUT 13
Analog IN 6	→	Analog OUT 14
Discrete OUT 9	←	Discrete IN 1
Discrete OUT 10	←	Discrete IN 2
Discrete OUT 11	←	Discrete IN 3
Discrete OUT 12	←	Discrete IN 4
Analog OUT 13	←	Analog IN 5
Analog OUT 14	←	Analog IN 6

MAP 2N

MAP 2N maps the I/O between the PM2 Gateway and two PM2 Nodes. Verify Node 1's rotary dials are set to 01 and Node 2's rotary dials are set to 02.

Gateway	Maps to	Node 1	Node 2
Discrete IN 1	→	Discrete OUT 9	
Discrete IN 2	→	Discrete OUT 10	
Discrete IN 3	→		Discrete OUT 9
Discrete IN 4	→		Discrete OUT 10
Analog IN 5	→	Analog OUT 13	
Analog IN 6	→		Analog OUT 13
Discrete OUT 9	←	Discrete IN 1	

Continued on page 7

Continued from page 6

Gateway	Maps to	Node 1	Node 2
Discrete OUT 10	←	Discrete IN 2	
Discrete OUT 11	←		Discrete IN 1
Discrete OUT 12	←		Discrete IN 2
Analog OUT 13	←	Analog IN 5	
Analog OUT 14	←		Analog IN 5

MAP 1R

MAP 1R maps the I/O from Node 1 to Node 7, using the Gateway as a repeater. Verify each Node's rotary dials are set to the appropriate ID. Set Node 1 to 01, set Node 2 to 02, through Node 7 set to 07.

Node 1	Maps to	Node 7
Discrete IN 1	→	Discrete OUT 9
Discrete IN 2	→	Discrete OUT 10
Discrete IN 3	→	Discrete OUT 11
Discrete IN 4	→	Discrete OUT 12
Analog IN 5	→	Analog OUT 13
Analog IN 6	→	Analog OUT 14
Discrete OUT 9	←	Discrete IN 1
Discrete OUT 10	←	Discrete IN 2
Discrete OUT 11	←	Discrete IN 3
Discrete OUT 12	←	Discrete IN 4
Analog OUT 13	←	Analog IN 5
Analog OUT 14	←	Analog IN 6

MAP 2R

Map 2R maps the I/O from Node 1 and Node 2 to Node 7, using the Gateway as a repeater. Verify Node 1's rotary dials are set to 01, Node 2's rotary dials are set to 02, and Node 7's rotary dials are set to 07.

Node 7	Maps to	Node 1	Node 2
Discrete IN 1	→	Discrete OUT 9	
Discrete IN 2	→	Discrete OUT 10	
Discrete IN 3	→		Discrete OUT 9
Discrete IN 4	→		Discrete OUT 10
Analog IN 5	→	Analog OUT 13	
Analog IN 6	→		Analog OUT 13
Discrete OUT 9	←	Discrete IN 1	
Discrete OUT 10	←	Discrete IN 2	
Discrete OUT 11	←		Discrete IN 1
Discrete OUT 12	←		Discrete IN 2
Analog OUT 13	←	Analog IN 5	
Analog OUT 14	←		Analog IN 5

UCTMAP

Select UCTMAP to use the User Configuration Tool (UCT) software to map I/O between the Gateway and its Nodes.

Installing Your Sure Cross® Radios

Please refer to one of these instruction manuals to install your wireless network components.

- DX80 Performance Wireless I/O Network Instruction Manual: [132607](#)
- MultiHop Data Radio Instruction Manual: [151317](#)

PM2 Modbus Registers

I/O	Modbus Holding Register		I/O Type	I/O Range		Holding Register Representation	
	Gateway	Any Node		Min. Value	Max. Value	Min. (Dec.)	Max. (Dec.)
1	1	1 + (Node# × 16)	Discrete IN 1	0	1	0	1
2	2	2 + (Node# × 16)	Discrete IN 2	0	1	0	1
3	3	3 + (Node# × 16)	Discrete IN 3	0	1	0	1
4	4	4 + (Node# × 16)	Discrete IN 4	0	1	0	1
5	5	5 + (Node# × 16)	Analog IN 5 (mA)	0.0	20.0	0	65535
6	6	6 + (Node# × 16)	Analog IN 6 (mA)	0.0	20.0	0	65535
7	7	7 + (Node# × 16)	Reserved				
8	8	8 + (Node# × 16)	Device Message				
9	9	9 + (Node# × 16)	Discrete OUT 9	0	1	0	1
10	10	10 + (Node# × 16)	Discrete OUT 10	0	1	0	1
11	11	11 + (Node# × 16)	Discrete OUT 11	0	1	0	1
12	12	12 + (Node# × 16)	Discrete OUT 12	0	1	0	1
13	13	13 + (Node# × 16)	Analog OUT 13 (mA)	0.0	20.0	0	65535
14	14	14 + (Node# × 16)	Analog OUT 14 (mA)	0.0	20.0	0	65535
15	15	15 + (Node# × 16)	Control Message				
16	16	16 + (Node# × 16)	Reserved				

Specifications

Radio Specifications for Performance Models

Supplied Antenna

A 2 dB antenna ships with this device. High-gain antennas are available, but the transmit power and range depends on the antenna gain, environment, and line of sight. Always verify your wireless network's range by performing a Site Survey.

Radio Transmit Power (900 MHz, 1 Watt radios)

Conducted: 30 dBm (1 W)
EIRP with the supplied 2 dB antenna: < 36 dBm

Radio Transmit Power (2.4 GHz radios)

Conducted: < 18 dBm (65 mW)
EIRP with the supplied 2 dB antenna: < 20 dBm (100 mW)

Radio Range

900 MHz (in 1 Watt mode): Up to 9.6 km (6 miles) with the supplied 2 dB antenna
2.4 GHz: Up to 3.2 km (2 miles) with the supplied 2 dB antenna

Antenna Minimum Separation Distance

900 MHz (transmitting at 1 Watt): 4.57 m (15 ft) with the supplied 2 dB antenna
2.4 GHz: 0.3 m (1 ft) with the supplied 2 dB antenna

Link Timeout (Performance)

Gateway: Configurable via User Configuration Software
Node: Defined by Gateway

Spread Spectrum Technology

FHSS (Frequency Hopping Spread Spectrum)

Antenna Connection

Ext. Reverse Polarity SMA, 50 Ohms
Max Tightening Torque: 0.45 N·m (4 lbf·in)

900 MHz Compliance (SX7023EXT Radio Module)

Radio module is indicated by the product label marking
Contains FCC ID: UE3SX7023EXT: FCC Part 15, Subpart C, 15.247
Contains IC: 7044A-SX7023EXT

900 MHz Compliance (RM1809 Radio Module)

Radio module is indicated by the product label marking
Contains FCC ID: UE3RM1809: FCC Part 15, Subpart C, 15.247
Contains IC: 7044A-RM1809
IFT: RCPBARM13-2283



2.4 GHz Compliance (DX80-2400 Radio Module)

Radio module is indicated by the product label marking
Contains FCC ID: UE300DX80-2400: FCC Part 15, Subpart C, 15.247
Radio Equipment Directive (RED) 2014/53/EU
Contains IC: 7044A-DX8024
ANATEL: 15966-21-04042



2.4 GHz Compliance (SX243 Radio Module)

Radio module is indicated by the product label marking
Contains FCC ID: UE3SX243: FCC Part 15, Subpart C,
15.247

Radio Equipment Directive (RED) 2014/53/EU
ETSI/EN: EN 300 328 V2.2.2 (2019-07) [RED HarmStds]

Contains IC: 7044A-SX243
ANATEL: 03737-22-04042

**RS-485 Communication Specifications****Communication Hardware (RS-485)**

Interface: 2-wire half-duplex RS-485

Baud rates: 9.6k, 19.2k (default), or 38.4k
Data format: 8 data bits, no parity, 1 stop bit

PM2 Specifications**Supply Voltage**

10 V DC to 30 V DC (Outside the USA: 12 V DC to 24 V DC,
 $\pm 10\%$)⁽¹⁾

Power Consumption

900 MHz Consumption: Maximum current draw is < 100 mA
and typical current draw is < 50 mA at 24 V DC. (2.4 GHz
consumption is less.)

Wiring Access

Two 1/2-inch NPT ports

Housing

Polycarbonate housing and rotary dial cover; polyester labels;
EDPM rubber cover gasket; nitrile rubber, non-sulphur cured
button covers

Weight: 0.26 kg (0.57 lbs)

Mounting: #10 or M5 (SS M5 hardware included)

Max. Tightening Torque: 0.56 N·m (5 lbf·in)

Interface

Two bi-color LED indicators, Two buttons, Six character LCD

Discrete Inputs

Four, DIP switch selectable between PNP and NPN

Rating: 3 mA max current at 30 V DC

Sample Rate: 62.5 milliseconds

Report Rate: On change of state

Discrete Input ON Condition

PNP: Greater than 8 V

NPN: Less than 0.7 V

Discrete Input OFF Condition

PNP: Less than 5 V

NPN: Greater than 2 V or open

Discrete Outputs

Four PNP

Update Rate: 125 milliseconds

ON Condition: Supply minus 2 V

OFF Condition: Less than 2 V

Output State Following Timeout: OFF

Discrete Output Rating (PNP)

100 mA max current at 30 V DC

ON-State Saturation: Less than 3 V at 100 mA

OFF-state Leakage: Less than 10 μ A

Analog Outputs

Two, 0 to 20 mA

Update Rate: 125 milliseconds

Accuracy: 0.1% of full scale +0.01% per °C

Resolution: 12-bit

Analog Inputs

Two, 0 to 20 mA

Input Rating: 24 mA

Impedance: Approximately 220 Ohms

Sample Rate: 62.5 milliseconds

Report Rate: 1 second or On Change of State (1% change in
value)

Accuracy: 0.2% of full scale +0.01% per °C

Resolution: 12-bit

Certifications

Banner Engineering BV
Park Lane, Culliganlaan 2F bus 3
1831 Diegem, BELGIUM



Turck Banner LTD Blenheim House
Blenheim Court
Wickford, Essex SS11 8YT
GREAT BRITAIN

(CE/UKCA approval only applies to 2.4 GHz models)

⁽¹⁾ For European applications, power this device from a Limited Power
Source as defined in EN 60950-1.

Environmental Specifications (IP67 Housing Models)**Operating Conditions**

-40 °C to +85 °C (-40 °F to +185 °F) (Electronics); -20 °C to
+80 °C (-4 °F to +176 °F) (LCD)

95% maximum relative humidity (non-condensing)

Radiated Immunity: 10 V/m (EN 61000-4-3)

Shock and Vibration

All models meet IEC 60068-2-6 and IEC 60068-2-27 testing
criteria

Shock: 30G 11 ms duration, half sine wave per IEC
60068-2-27

Vibration: 10 Hz to 55 Hz, 0.5 mm peak-to-peak amplitude per
IEC 60068-2-6

Environmental Ratings

IEC IP67; NEMA 6

For installation and waterproofing instructions, go
to www.bannerengineering.com and search for the complete
instruction manual (p/n 132607)

Operating the devices at the maximum operating conditions for extended periods can shorten the life of the device.

Environmental Specifications for the C Housings

Operating Conditions

−40 °C to +85 °C (−40 °F to +185 °F) (Electronics); −20 °C to +80 °C (−4 °F to +176 °F) (LCD)

95% maximum relative humidity (non-condensing)

Radiated Immunity: 10 V/m (EN 61000-4-3)

Shock and Vibration

All models meet IEC 60068-2-6 and IEC 60068-2-27 testing criteria

Shock: 30G 11 ms duration, half sine wave per IEC 60068-2-27

Vibration: 10 Hz to 55 Hz, 0.5 mm peak-to-peak amplitude per IEC 60068-2-6

Environmental Ratings

"C" Housing Models/External wiring terminals: IEC IP20; NEMA 1

Refer to the Sure Cross® DX80 Performance (p/n [132607](#)) or the Sure Cross® MultiHop (p/n [151317](#)) instruction manual for installation and waterproofing instructions.

Operating the devices at the maximum operating conditions for extended periods can shorten the life of the device.

FCC Part 15 Class A for Intentional Radiators

This equipment has been tested and found to comply with the limits for a Class A digital device, pursuant to part 15 of the FCC Rules. These limits are designed to provide reasonable protection against harmful interference when the equipment is operated in a commercial environment. This equipment generates, uses, and can radiate radio frequency energy and, if not installed and used in accordance with the instruction manual, may cause harmful interference to radio communications. Operation of this equipment in a residential area is likely to cause harmful interference in which case the user will be required to correct the interference at his own expense.

Industry Canada Statement for Intentional Radiators

This device contains licence-exempt transmitters(s)/receiver(s) that comply with Innovation, Science and Economic Development Canada's licence-exempt RSS(s). Operation is subject to the following two conditions:

1. This device may not cause interference.
2. This device must accept any interference, including interference that may cause undesired operation of the device.

Cet appareil contient des émetteurs/récepteurs exemptés de licence conformes à la norme Innovation, Sciences, et Développement économique Canada. L'exploitation est autorisée aux deux conditions suivantes:

1. L'appareil ne doit pas produire de brouillage.
2. L'utilisateur de l'appareil doit accepter tout brouillage radioélectrique subi, même si le brouillage est susceptible d'en compromettre le fonctionnement.

Included with Model

The following items ship with the PM2 and PM8 radios.

- One 1/2-inch NPT plug (not included with IP20 "C" models)
- Two 1/2-inch nylon gland fittings (not included with IP20 "C" models)
- **BWA-902-C** (900 MHz) or **BWA-202-C** (2.4 GHz) Antenna, 2 dBd Omni, Rubber Swivel RP-SMA Male
- **BWA-HW-011** IP20 Screw Terminal Headers (2 pack) (IP20 "C" models only)

Warnings

WARNING:



- **Do not use this device for personnel protection**
- Using this device for personnel protection could result in serious injury or death.
- This device does not include the self-checking redundant circuitry necessary to allow its use in personnel safety applications. A device failure or malfunction can cause either an energized (on) or de-energized (off) output condition.

IMPORTANT: Please download the complete Performance PM2 Gateway technical documentation, available in multiple languages, from www.bannerengineering.com for details on the proper use, applications, Warnings, and installation instructions of this device.

IMPORTANT: Por favor descargue desde www.bannerengineering.com toda la documentación técnica de los Performance PM2 Gateway, disponibles en múltiples idiomas, para detalles del uso adecuado, aplicaciones, advertencias, y las instrucciones de instalación de estos dispositivos.

IMPORTANT: Veuillez télécharger la documentation technique complète des Performance PM2 Gateway sur notre site www.bannerengineering.com pour les détails sur leur utilisation correcte, les applications, les notes de sécurité et les instructions de montage.

Install and properly ground a qualified surge suppressor when installing a remote antenna system. Remote antenna configurations installed without surge suppressors invalidate the manufacturer's warranty. Keep the ground wire as short as possible and make all ground connections to a single-point ground system to ensure no ground loops are created. No surge suppressor can absorb all lightning strikes; do not touch the Sure Cross® device or any equipment connected to the Sure Cross® device during a thunderstorm.

Exporting Sure Cross® Radios. It is our intent to fully comply with all national and regional regulations regarding radio frequency emissions. **Customers who want to re-export this product to a country other than that to which it was sold must ensure the device is approved in the destination country.** The Sure Cross wireless products were certified for use in these countries using the antenna that ships with the product. When using other antennas, verify you are not exceeding the transmit power levels allowed by local governing agencies. This device has been designed to operate with the antennas listed on Banner Engineering's website and having a maximum gain of 9 dBm. Antennas not included in this list or having a gain greater than 9 dBm are strictly prohibited for use with this device. The required antenna impedance is 50 ohms. To reduce potential radio interference to other users, the antenna type and its gain should be so chosen such that the equivalent isotropically radiated power (EIRP) is not more than that permitted for successful communication. Consult with Banner Engineering Corp. if the destination country is not on this list.

IMPORTANT:

- **Never operate a 1 Watt radio without connecting an antenna**
- Operating 1 Watt radios without an antenna connected will damage the radio circuitry.
- To avoid damaging the radio circuitry, never apply power to a Sure Cross® Performance or Sure Cross MultiHop (1 Watt) radio without an antenna connected.

IMPORTANT:

- **Electrostatic discharge (ESD) sensitive device**
- ESD can damage the device. Damage from inappropriate handling is not covered by warranty.
- Use proper handling procedures to prevent ESD damage. Proper handling procedures include leaving devices in their anti-static packaging until ready for use; wearing anti-static wrist straps; and assembling units on a grounded, static-dissipative surface.

Banner Engineering Corp Limited Warranty

Banner Engineering Corp. warrants its products to be free from defects in material and workmanship for one year following the date of shipment. Banner Engineering Corp. will repair or replace, free of charge, any product of its manufacture which, at the time it is returned to the factory, is found to have been defective during the warranty period. This warranty does not cover damage or liability for misuse, abuse, or the improper application or installation of the Banner product.

THIS LIMITED WARRANTY IS EXCLUSIVE AND IN LIEU OF ALL OTHER WARRANTIES WHETHER EXPRESS OR IMPLIED (INCLUDING, WITHOUT LIMITATION, ANY WARRANTY OF MERCHANTABILITY OR FITNESS FOR A PARTICULAR PURPOSE), AND WHETHER ARISING UNDER COURSE OF PERFORMANCE, COURSE OF DEALING OR TRADE USAGE.

This Warranty is exclusive and limited to repair or, at the discretion of Banner Engineering Corp., replacement. **IN NO EVENT SHALL BANNER ENGINEERING CORP. BE LIABLE TO BUYER OR ANY OTHER PERSON OR ENTITY FOR ANY EXTRA COSTS, EXPENSES, LOSSES, LOSS OF PROFITS, OR ANY INCIDENTAL, CONSEQUENTIAL OR SPECIAL DAMAGES RESULTING FROM ANY PRODUCT DEFECT OR FROM THE USE OR INABILITY TO USE THE PRODUCT, WHETHER ARISING IN CONTRACT OR WARRANTY, STATUTE, TORT, STRICT LIABILITY, NEGLIGENCE, OR OTHERWISE.**

Banner Engineering Corp. reserves the right to change, modify or improve the design of the product without assuming any obligations or liabilities relating to any product previously manufactured by Banner Engineering Corp. Any misuse, abuse, or improper application or installation of this product or use of the product for personal protection applications when the product is identified as not intended for such purposes will void the product warranty. Any modifications to this product without prior express approval by Banner Engineering Corp will void the product warranties. All specifications published in this document are subject to change; Banner reserves the right to modify product specifications or update documentation at any time. Specifications and product information in English supersedes that which is provided in any other language. For the most recent version of any documentation, refer to: www.bannerengineering.com.

For patent information, see www.bannerengineering.com/patents.

Notas Adicionales (con Antena)

Información México: La operación de este equipo está sujeta a las siguientes dos condiciones: 1) es posible que este equipo o dispositivo no cause interferencia perjudicial y 2) este equipo debe aceptar cualquier interferencia, incluyendo la que pueda causar su operación no deseada.

Banner es una marca registrada de Banner Engineering Corp. y podrán ser utilizadas de manera indistinta para referirse al fabricante. "Este equipo ha sido diseñado para operar con las antenas tipo Omnidireccional para una ganancia máxima de antena de 6 dBd y Yagi para una ganancia máxima de antena 10 dBd que en seguida se enlistan. También se incluyen aquellas con aprobación ATEX tipo Omnidireccional

siempre que no excedan una ganancia máxima de antena de 6dBd. El uso con este equipo de antenas no incluidas en esta lista o que tengan una ganancia mayor que 6 dBd en tipo omnidireccional y 10 dBd en tipo Yagi, quedan prohibidas. La impedancia requerida de la antena es de 50 ohms."

Approved Antennas

- BWA-9O2-C**--Antena, Omni 902-928 MHz, 2 dBd, junta de caucho, RP-SMA Macho
- BWA-9O5-C**--Antena, Omni 902-928 MHz, 5 dBd, junta de caucho, RP-SMA Macho
- BWA-9O6-A**--Antena, Omni 902-928 MHz, 6 dBd, fibra de vidrio, 1800mm, N Hembra
- BWA-9Y10-A**--Antena, Yagi, 900 MHz, 10 dBd, N Hembra

Mexican Importer

Banner Engineering de México, S. de R.L. de C.V. | David Alfaro Siqueiros 103 Piso 2 Valle oriente | San Pedro Garza Garcia Nuevo León, C. P. 66269

81 8363.2714

Document title: Sure Cross® Performance PM2 Gateway with IO Mapping

Part number: 173566

Revision: H

Original Instructions

© Banner Engineering Corp. All rights reserved.



173566