

Notice for TAIYO YUDEN Products

Please read this notice before using the TAIYO YUDEN products.

⚠ REMINDERS

Product Information in this Catalog

Product information in this catalog is as of March 2023. All of the contents specified herein and production status of the products listed in this catalog are subject to change without notice due to technical improvement of our products, etc. Therefore, please check for the latest information carefully before practical application or use of our products.

Please note that TAIYO YUDEN shall not be in any way responsible for any damages and defects in products or equipment incorporating our products, which are caused under the conditions other than those specified in this catalog or individual product specification sheets.

Approval of Product Specifications

Please contact TAIYO YUDEN for further details of product specifications as the individual product specification sheets are available. When using our products, please be sure to approve our product specifications or make a written agreement on the product specification with TAIYO YUDEN in advance.

Pre-Evaluation in the Actual Equipment and Conditions

Please conduct validation and verification of our products in actual conditions of mounting and operating environment before using our products.

Limited Application

1. Equipment Intended for Use

The products listed in this catalog are intended for general-purpose and standard use in general electronic equipment for consumer (e.g., AV equipment, OA equipment, home electric appliances, office equipment, information and communication equipment including, without limitation, mobile phone, and PC) and other equipment specified in this catalog or the individual product specification sheets, or the equipment approved separately by TAIYO YUDEN.

TAIYO YUDEN has the product series intended for use in the following equipment. Therefore, when using our products for these equipment, please check available applications specified in this catalog or the individual product specification sheets and use the corresponding products.

Application	Product Series		Quality Grade ^{*3}
	Equipment ^{*1}	Category (Part Number Code ^{*2})	
Automotive	Automotive Electronic Equipment (POWERTRAIN, SAFETY)	A	1
	Automotive Electronic Equipment (BODY & CHASSIS, INFOTAINMENT)	C	2
Industrial	Telecommunications Infrastructure and Industrial Equipment	B	2
Medical	Medical Devices classified as GHTF Class C (Japan Class III)	M	2
	Medical Devices classified as GHTF Classes A or B (Japan Classes I or II)	L	3
Consumer	General Electronic Equipment	S	3
	Only for Mobile Devices ^{*4}	E	4

*Notes: 1. Based on the general specifications required for electronic components for such equipment, which are recognized by TAIYO YUDEN, the use of each product series for the equipment is recommended. Please be sure to contact TAIYO YUDEN before using our products for equipment other than those covered by the product series.

2. On each of our part number, the 2nd code from the left is a code indicating the "Category" as shown in the above table. For details, please check the explanatory materials regarding the part numbering system of each of our products.

3. Each product series is assigned a "Quality Grade" from 1 to 4 in order of higher quality. Please do not incorporate a product into any equipment with a higher Quality Grade than the Quality Grade of such product without the prior written consent of TAIYO YUDEN.

4. The applications covered by this product series are limited to mobile devices (smartphone, tablet PC, smartwatch, handheld game console, etc.) among general electronic equipment for consumer. The design, specifications and operating environment, etc. differ from those of the product series for "General Electronic Equipment" (Category: S), so please check the individual product specification sheets for details. The product series for "General Electronic Equipment" (Category: S) can also be used for mobile devices.

▶ This catalog contains the typical specification only due to the limitation of space. When you consider the purchase of our products, please check our product specification sheets. For details of each product (characteristics graph, reliability information, precautions for use, and so on), see our website (<http://www.ty-top.com/>).

2. Equipment Requiring Inquiry

Please be sure to contact TAIYO YUDEN for further information before using the products listed in this catalog for the following equipment (excluding intended equipment as specified in this catalog or the individual product specification sheets) which may cause loss of human life, bodily injury, serious property damage and/or serious public impact due to a failure or defect of the products and/or malfunction attributed thereto.

- (1) Transportation equipment (automotive powertrain control system, train control system, and ship control system, etc.)
- (2) Traffic signal equipment
- (3) Disaster prevention equipment, crime prevention equipment
- (4) Medical devices classified as GHTF Class C (Japan Class III)
- (5) Highly public information network equipment, data-processing equipment (telephone exchange, and base station, etc.)
- (6) Any other equipment requiring high levels of quality and/or reliability equal to the equipment listed above

3. Equipment Prohibited for Use

Please do not incorporate our products into the following equipment requiring extremely high levels of safety and/or reliability.

- (1) Aerospace equipment (artificial satellite, rocket, etc.)
- (2) Aviation equipment *1
- (3) Medical devices classified as GHTF Class D (Japan Class IV), implantable medical devices *2
- (4) Power generation control equipment (nuclear power, hydroelectric power, thermal power plant control system, etc.)
- (5) Undersea equipment (submarine repeating equipment, etc.)
- (6) Military equipment
- (7) Any other equipment requiring extremely high levels of safety and/or reliability equal to the equipment listed above

*Notes: 1. There is a possibility that our products can be used only for aviation equipment that does not directly affect the safe operation of aircraft (e.g., in-flight entertainment, cabin light, electric seat, cooking equipment) if such use meets requirements specified separately by TAIYO YUDEN. Please be sure to contact TAIYO YUDEN for further information before using our products for such aviation equipment.

2. Implantable medical devices contain not only internal unit which is implanted in a body, but also external unit which is connected to the internal unit.

4. Limitation of Liability

Please note that unless you obtain prior written consent of TAIYO YUDEN, TAIYO YUDEN shall not be in any way responsible for any damages incurred by you or third parties arising from use of the products listed in this catalog for any equipment that is not intended for use by TAIYO YUDEN, or any equipment requiring inquiry to TAIYO YUDEN or prohibited for use by TAIYO YUDEN as described above.

■ Safety Design

When using our products for high safety and/or reliability-required equipment or circuits, please fully perform safety and/or reliability evaluation. In addition, please install (i) systems equipped with a protection circuit and a protection device and/or (ii) systems equipped with a redundant circuit or other system to prevent an unsafe status in the event of a single fault for a failsafe design to ensure safety.

■ Intellectual Property Rights

Information contained in this catalog is intended to convey examples of typical performances and/or applications of our products and is not intended to make any warranty with respect to the intellectual property rights or any other related rights of TAIYO YUDEN or any third parties nor grant any license under such rights.

■ Limited Warranty

Please note that the scope of warranty for our products is limited to the delivered our products themselves conforming to the product specifications specified in the individual product specification sheets, and TAIYO YUDEN shall not be in any way responsible for any damages resulting from a failure or defect in our products. Notwithstanding the foregoing, if there is a written agreement (e.g., supply and purchase agreement, quality assurance agreement) signed by TAIYO YUDEN and your company, TAIYO YUDEN will warrant our products in accordance with such agreement, provided, however, that our products shall be used for general-purpose and standard use in the equipment specified in this catalog or the individual product specification sheets.

■ TAIYO YUDEN's Official Sales Channel

The contents of this catalog are applicable to our products which are purchased from our sales offices or authorized distributors (hereinafter "TAIYO YUDEN's official sales channel"). Please note that the contents of this catalog are not applicable to our products purchased from any seller other than TAIYO YUDEN's official sales channel.

■ Caution for Export

Some of our products listed in this catalog may require specific procedures for export according to "U.S. Export Administration Regulations", "Foreign Exchange and Foreign Trade Control Law" of Japan, and other applicable regulations. Should you have any questions on this matter, please contact our sales staff.

▶ This catalog contains the typical specification only due to the limitation of space. When you consider the purchase of our products, please check our product specification sheets. For details of each product (characteristics graph, reliability information, precautions for use, and so on), see our website (<http://www.ty-top.com/>).

Automotive Application Guide

We classify automotive electronic equipment into the following four application categories and set usable application categories for each of our products. Therefore, we have the corresponding product series (the 2nd code from the left side of the part number is “A” or “C”). When using our products for automotive electronic equipment, please be sure to check such application categories and use the corresponding product series accordingly. Should you have any questions on this matter, please contact us.

Product Series (The 2nd Code from the Left Side of the Part Number)	Category	Automotive Electronic Equipment (Typical Example)
A	POWERTRAIN	<ul style="list-style-type: none"> • Engine ECU (Electronically Controlled Fuel Injector) • Cruise Control Unit • 4WS (4 Wheel Steering) • Transmission • Power Steering • HEV/PHV/EV Core Control (Battery, Inverter, DC-DC) • Automotive Locator (Car location information providing device), etc.
	SAFETY	<ul style="list-style-type: none"> • ABS (Anti-Lock Brake System) • ESC (Electronic Stability Control) • Airbag • ADAS (Equipment that directly controls running, turning and stopping), etc.
C	BODY & CHASSIS	<ul style="list-style-type: none"> • Wiper • Automatic Door • Power Window • Keyless Entry System • Electric Door Mirror • Automobile Digital Mirror • Interior Lighting • Automobile Air Conditioning System • TPMS (Tire Pressure Monitoring System) • Anti-Theft Device (Immobilizer) • ADAS (Sensor, Equipment that is not interlocked with safety equipment or powertrain), etc.
	INFOTAINMENT	<ul style="list-style-type: none"> • Car Infotainment System • ITS/Telematics System • Instrument Cluster Panel • Dashcam (genuine products for automotive manufacturer), etc.

Multilayer Ceramic Capacitors for Automotive Powertrain and Safety

REFLOW

AEC-Q200

■ PART NUMBER

M	A	A	S	J	3	1	L	A	B	7	1	0	6	K	T	N	A	0	1
①	②	③	④	⑤	⑥	⑦	⑧	⑨	⑩										

① Series

Code (1)(2)(3)(4)	
MAAS	Multilayer Ceramic Capacitor (High dielectric type) for Automotive Powertrain and Safety

(1) Product Group

Code	
M	Multilayer Ceramic Capacitor

(3) Type

Code	
A	2 terminals

(2) Category

Code	Recommended equipment	Quality Grade
A	Automotive Electronic Equipment (Powertrain, Safety)	1

(4) Features, Characteristics

Code	
S	Standard/General

② Rated voltage

Code	Rated voltage [VDC]
A	4
J	6.3
L	10
E	16
T	25
U	50
H	100

④ Thickness

Code	Thickness [mm]
3	0.3
5	0.5
8	0.8
Q	1.15
G	1.25
L	1.6
N	1.9
M	2.5

③ Dimension (L × W)

Code	L × W [mm]	JIS(mm)	EIA(inch)
06	0.6 × 0.3	0603	0201
10	1.0 × 0.5	1005	0402
16	1.6 × 0.8	1608	0603
21	2.0 × 1.25	2012	0805
31	3.2 × 1.6	3216	1206
32	3.2 × 2.5	3225	1210

⑤ Dimension tolerance

Code	Dimension code	L [mm]	W [mm]	T [mm]	Thickness code
A	10	1.0±0.10	0.5±0.10	0.5±0.10	5
	16	1.6+0.15/-0.05	0.8+0.15/-0.05	0.8+0.15/-0.05	8
	21	2.0+0.15/-0.05	1.25+0.15/-0.05	1.25+0.15/-0.05	G
	31	3.2±0.20	1.6±0.20	1.6±0.20	L
	32	3.2±0.30	2.5±0.30	2.5±0.30	M
B	21	2.0+0.20/-0	1.25+0.20/-0	1.25+0.20/-0	G
	31	3.2±0.30	1.6±0.30	1.6±0.30	L
C	10	1.0+0.20/-0	0.5+0.20/-0	0.5+0.20/-0	5
	21	2.0+0.25/-0	1.25+0.25/-0	1.25+0.25/-0	G
H	31	3.2±0.15	1.6±0.15	1.15±0.10	Q
S	06	0.6±0.03	0.3±0.03	0.3±0.03	3
	10	1.0±0.05	0.5±0.05	0.5±0.05	5
	16	1.6±0.10	0.8±0.10	0.8±0.10	8
	21	2.0±0.10	1.25±0.10	1.25±0.10	G
	31	3.2±0.15	1.6±0.15	1.6±0.20	L
	32	3.2±0.30	2.5±0.20	1.9±0.20 2.5±0.20	N M

⑥ Temperature characteristics code

■ High dielectric type

Code	Applicable standard		Temperature range [°C]	Ref. Temp. [°C]	Capacitance change	Capacitance tolerance	Tolerance code
B7	EIA	X7R	-55 ~ +125	25	±15%	±10%	K
						±20%	M
C7	EIA	X7S	-55 ~ +125	25	±22%	±10%	K
						±20%	M
D7	EIA	X7T	-55 ~ +125	25	+22% / -33%	±10%	K
						±20%	M

⑦ Nominal capacitance

Code (example)	Nominal capacitance
101	100pF
102	1,000pF
103	0.01μF
104	0.1μF
105	1μF
106	10μF

⑨ Packaging

Code	Packaging
F	φ178mm Taping (2mm pitch)
T	φ178mm Taping (4mm pitch)
P	φ178mm Taping (4mm pitch, 1000 pcs/reel) 3225 type (Thickness code M)

⑩ Internal code

⑧ Capacitance tolerance

Code	Capacitance tolerance
K	±10%
M	±20%

■ STANDARD EXTERNAL DIMENSIONS

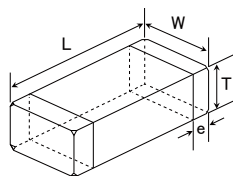

Type	JIS (mm)	EIA (inch)	Dimension [mm] (inch)				
			L	W	T	*1	e
MAAS□06	0603	0201	0.6±0.03 (0.024±0.001)	0.3±0.03 (0.012±0.001)	0.3±0.03 (0.012±0.001)	3	0.15±0.05 (0.006±0.002)
MAAS□10	1005	0402	1.0±0.05 (0.039±0.002)	0.5±0.05 (0.020±0.002)	0.5±0.05 (0.020±0.002)	5	0.25±0.10 (0.010±0.004)
MAAS□16	1608	0603	1.6±0.10 (0.063±0.004)	0.8±0.10 (0.031±0.004)	0.8±0.10 (0.031±0.004)	8	0.35±0.25 (0.014±0.010)
MAAS□21	2012	0805	2.0±0.10 (0.079±0.004)	1.25±0.10 (0.049±0.004)	1.25±0.10 (0.049±0.004)	G	0.5±0.25 (0.020±0.010)
MAAS□31	3216	1206	3.2±0.15 (0.126±0.006)	1.6±0.15 (0.063±0.006)	1.15±0.10 (0.045±0.004)	Q	0.5+0.35/-0.25 (0.020+0.014/-0.010)
					1.6±0.20 (0.063±0.008)	L	
MAAS□32	3225	1210	3.2±0.30 (0.126±0.012)	2.5±0.20 (0.098±0.008)	1.9±0.20 (0.075±0.008)	N	0.6±0.3 (0.024±0.012)
					2.5±0.20 (0.098±0.008)	M	

*1.Thickness code

■ STANDARD QUANTITY

Type			Thickness		Standard quantity [pcs]	
Code	JIS(mm)	EIA(inch)	[mm]	Code	Paper tape	Embossed tape
06	0603	0201	0.3	3	15000	—
10	1005	0402	0.5	5	10000	—
16	1608	0603	0.8	8	4000	—
21	2012	0805	1.25	G	—	3000
31	3216	1206	1.15	Q	—	3000
			1.6	L	—	2000
32	3225	1210	1.9	N	—	2000
			2.5	M	—	500(T), 1000(P)

■ PART NUMBER

- All the Multilayer Ceramic Capacitors of the catalog lineup are RoHS compliant.
- Capacitance tolerance code is applied to □ of part number.
- All the Multilayer Ceramic Capacitors in the catalog lineup are applicable for reflow-soldering.

Notes)

- The exchange of individual specifications is necessary depending on your application and/or circuit condition. Please contact TAIYO YUDEN's official sales channel.
- For Automotive (AEC-Q200 Qualified) products for POWERTRAIN and SAFETY. Please check "Automotive Application Guide" for further details before using the products.
 < AEC-Q200 : AEC-Q200 qualified >

All the Multilayer Ceramic Capacitors for Automotive products are tested based on the test conditions and methods defined in AEC-Q200 by family item.
 125°C products: AEC-Q200 Grade1 (we conduct the evaluation at the test condition of Grade1.)

Please consult with TAIYO YUDEN's official sales channel for the details of the product specifications and AEC-Q200 test results, etc., and please review and approve the product specifications before ordering.

- *1: For standard case size, please kindly refer to Dimension, Thickness, Dimension tolerance, and STANDARD EXTERNAL DIMENSIONS.

Multilayer Ceramic Capacitors (High dielectric type) for Automotive Powertrain and Safety

● 0603TYPE

【Temperature Characteristic B7 : X7R (−55~+125°C), D7 : X7T (−55~+125°C)】 0.3mm Thickness

New part number	Old part number (for reference)	Rated voltage [V]	Temperature characteristics	Capacitance [F]	Capacitance tolerance [%]	tan δ [%]	HTLT		Thickness*1 [mm]	Note
							Rated voltage x %			
MAAST063SB7101□FCA01	TMR063 B7101□P-F	25	X7R	100 p	±10, ±20	3.5	200	0.3±0.03		
MAAST063SB7151□FCA01	TMR063 B7151□P-F		X7R	150 p	±10, ±20	3.5	200	0.3±0.03		
MAAST063SB7221□FCA01	TMR063 B7221□P-F		X7R	220 p	±10, ±20	3.5	200	0.3±0.03		
MAAST063SB7331□FCA01	TMR063 B7331□P-F		X7R	330 p	±10, ±20	3.5	200	0.3±0.03		
MAAST063SB7471□FCA01	TMR063 B7471□P-F		X7R	470 p	±10, ±20	3.5	200	0.3±0.03		
MAAST063SB7681□FCA01	TMR063 B7681□P-F		X7R	680 p	±10, ±20	5	200	0.3±0.03		
MAAST063SB7102□FCA01	TMR063 B7102□P-F		X7R	1000 p	±10, ±20	3.5	200	0.3±0.03		
MAAST063SB7152□FCA01	TMR063 B7152□P-F		X7R	1500 p	±10, ±20	5	200	0.3±0.03		
MAAST063SB7222□FCA01	TMR063 B7222□P-F		X7R	2200 p	±10, ±20	5	200	0.3±0.03		
MAAST063SB7332□FCA01	TMR063 B7332□P-F		X7R	3300 p	±10, ±20	5	200	0.3±0.03		
MAASE063SB7101□FCA01	EMR063 B7101□P-F		X7R	100 p	±10, ±20	3.5	200	0.3±0.03		
MAASE063SB7151□FCA01	EMR063 B7151□P-F		X7R	150 p	±10, ±20	3.5	200	0.3±0.03		
MAASE063SB7221□FCA01	EMR063 B7221□P-F		X7R	220 p	±10, ±20	3.5	200	0.3±0.03		
MAASE063SB7331□FCA01	EMR063 B7331□P-F		X7R	330 p	±10, ±20	3.5	200	0.3±0.03		
MAASE063SB7471□FCA01	EMR063 B7471□P-F		X7R	470 p	±10, ±20	3.5	200	0.3±0.03		
MAASE063SB7681□FCA01	EMR063 B7681□P-F		X7R	680 p	±10, ±20	5	200	0.3±0.03		
MAASE063SB7102□FCA01	EMR063 B7102□P-F	X7R	1000 p	±10, ±20	3.5	200	0.3±0.03			
MAASE063SB7152□FCA01	EMR063 B7152□P-F	X7R	1500 p	±10, ±20	5	200	0.3±0.03			
MAASE063SB7222□FCA01	EMR063 B7222□P-F	X7R	2200 p	±10, ±20	5	200	0.3±0.03			
MAASE063SB7332□FCA01	EMR063 B7332□P-F	X7R	3300 p	±10, ±20	5	200	0.3±0.03			
MAASL063SB7101□FCA01	LMR063 B7101□P-F	10	X7R	100 p	±10, ±20	3.5	200	0.3±0.03		
MAASL063SB7151□FCA01	LMR063 B7151□P-F		X7R	150 p	±10, ±20	3.5	200	0.3±0.03		
MAASL063SB7221□FCA01	LMR063 B7221□P-F		X7R	220 p	±10, ±20	3.5	200	0.3±0.03		
MAASL063SB7331□FCA01	LMR063 B7331□P-F		X7R	330 p	±10, ±20	3.5	200	0.3±0.03		
MAASL063SB7471□FCA01	LMR063 B7471□P-F		X7R	470 p	±10, ±20	3.5	200	0.3±0.03		
MAASL063SB7681□FCA01	LMR063 B7681□P-F		X7R	680 p	±10, ±20	5	200	0.3±0.03		
MAASL063SB7102□FCA01	LMR063 B7102□P-F		X7R	1000 p	±10, ±20	3.5	200	0.3±0.03		
MAASL063SB7152□FCA01	LMR063 B7152□P-F		X7R	1500 p	±10, ±20	5	200	0.3±0.03		
MAASL063SB7222□FCA01	LMR063 B7222□P-F		X7R	2200 p	±10, ±20	5	200	0.3±0.03		
MAASL063SB7332□FCA01	LMR063 B7332□P-F		X7R	3300 p	±10, ±20	5	200	0.3±0.03		
MAASL063SB7472□FCA01	LMR063 B7472□P-F		X7R	4700 p	±10, ±20	5	200	0.3±0.03		
MAASL063SB7682□FCA01	LMR063 B7682□P-F		X7R	6800 p	±10, ±20	5	200	0.3±0.03		
MAASL063SB7103□FCA01	LMR063 B7103□P-F		X7R	0.01 μ	±10, ±20	5	200	0.3±0.03		
MAASJ063SD7223□FCA01	JMR063 D7223□P-F		6.3	X7T	0.022 μ	±10, ±20	7.5	200	0.3±0.03	
MAASJ063SD7333□FCA01	JMR063 D7333□P-F			X7T	0.033 μ	±10, ±20	7.5	200	0.3±0.03	
MAASJ063SD7473□FCA01	JMR063 D7473□P-F			X7T	0.047 μ	±10, ±20	7.5	200	0.3±0.03	
MAASJ063SD7104□FCA01	JMR063 D7104□P-F	X7T		0.1 μ	±10, ±20	10	200	0.3±0.03		

▶ This catalog contains the typical specification only due to the limitation of space. When you consider the purchase of our products, please check our specification.
 For details of each product (characteristics graph, reliability information, precautions for use, and so on), see our Web site (<http://www.ty-top.com/>).

PART NUMBER

1005TYPE

【Temperature Characteristic B7 : X7R (−55~+125°C), D7 : X7T (−55~+125°C)】 0.5mm Thickness

New part number	Old part number (for reference)	Rated voltage [V]	Temperature characteristics	Capacitance [F]	Capacitance tolerance [%]	tan δ [%]	HTLT	Thickness*1 [mm]	Note	
							Rated voltage x %			
MAASH105SB7221[FCA01	HMR105 B7221[V-F	100	X7R	220 p	±10, ±20	3.5	200	0.5±0.05		
MAASH105SB7331[FCA01	HMR105 B7331[V-F		X7R	330 p	±10, ±20	3.5	200	0.5±0.05		
MAASH105SB7471[FCA01	HMR105 B7471[V-F		X7R	470 p	±10, ±20	3.5	200	0.5±0.05		
MAASH105SB7681[FCA01	HMR105 B7681[V-F		X7R	680 p	±10, ±20	3.5	200	0.5±0.05		
MAASH105SB7102[FCA01	HMR105 B7102[V-F		X7R	1000 p	±10, ±20	3.5	200	0.5±0.05		
MAASH105SB7152[FCA01	HMR105 B7152[V-F		X7R	1500 p	±10, ±20	3.5	200	0.5±0.05		
MAASH105SB7222[FCA01	HMR105 B7222[V-F		X7R	2200 p	±10, ±20	3.5	200	0.5±0.05		
MAASH105SB7332[FCA01	HMR105 B7332[V-F		X7R	3300 p	±10, ±20	3.5	200	0.5±0.05		
MAASH105SB7472[FCA01	HMR105 B7472[V-F		X7R	4700 p	±10, ±20	3.5	200	0.5±0.05		
MAASH105SB7682[FCA01	HMR105 B7682[V-F		X7R	6800 p	±10, ±20	3.5	200	0.5±0.05		
MAASH105SB7103[FCA01	HMR105 B7103[V-F		X7R	0.01 μ	±10, ±20	3.5	200	0.5±0.05		
MAASU105SB7221[FCA01	UMR105 B7221[V-F		X7R	220 p	±10, ±20	3.5	200	0.5±0.05		
MAASU105SB7331[FCA01	UMR105 B7331[V-F		X7R	330 p	±10, ±20	3.5	200	0.5±0.05		
MAASU105SB7471[FCA01	UMR105 B7471[V-F		X7R	470 p	±10, ±20	3.5	200	0.5±0.05		
MAASU105SB7681[FCA01	UMR105 B7681[V-F	X7R	680 p	±10, ±20	3.5	200	0.5±0.05			
MAASU105SB7102[FNA01	UMF105 B7102[VHF	50	X7R	1000 p	±10, ±20	3.5	200	0.5±0.05		
MAASU105SB7222[FNA01	UMF105 B7222[VHF		X7R	2200 p	±10, ±20	3.5	200	0.5±0.05		
MAASU105SB7472[FNA01	UMF105 B7472[VHF		X7R	4700 p	±10, ±20	3.5	150	0.5±0.05		
MAASU105SB7103[FNA01	UMF105 B7103[VHF		X7R	0.01 μ	±10, ±20	3.5	150	0.5±0.05		
MAASU105SB7153[FCA01	UMR105 B7153[V-F		X7R	0.015 μ	±10, ±20	3.5	200	0.5±0.05		
MAASU105SB7223[FCA01	UMR105 B7223[V-F		X7R	0.022 μ	±10, ±20	3.5	200	0.5±0.05		
MAASU105SB7333[FCA01	UMR105 B7333[V-F		X7R	0.033 μ	±10, ±20	3.5	150	0.5±0.05		
MAASU105SB7473[FCA01	UMR105 B7473[V-F		X7R	0.047 μ	±10, ±20	3.5	150	0.5±0.05		
MAASU105AB7683[FCA01	UMR105AB7683[V-F		X7R	0.068 μ	±10, ±20	5	150	0.5±0.1		
MAASU105AB7104[FCA01	UMR105AB7104[V-F		X7R	0.1 μ	±10, ±20	5	150	0.5±0.1		
MAAST105SB7102[FNA01	TMF105 B7102[VHF		25	X7R	1000 p	±10, ±20	2.5	200	0.5±0.05	
MAAST105SB7222[FNA01	TMF105 B7222[VHF			X7R	2200 p	±10, ±20	2.5	200	0.5±0.05	
MAAST105SB7472[FNA01	TMF105 B7472[VHF			X7R	4700 p	±10, ±20	2.5	200	0.5±0.05	
MAAST105SB7103[FNA01	TMF105 B7103[VHF			X7R	0.01 μ	±10, ±20	3.5	200	0.5±0.05	
MAAST105SB7223[FNA01	TMF105 B7223[VHF	X7R		0.022 μ	±10, ±20	3.5	150	0.5±0.05		
MAAST105SB7473[FNA01	TMF105 B7473[VHF	X7R		0.047 μ	±10, ±20	3.5	150	0.5±0.05		
MAAST105AB7683[FCA01	TMR105AB7683[V-F	X7R		0.068 μ	±10, ±20	5	200	0.5±0.1		
MAAST105AB7104[FCA01	TMR105AB7104[V-F	X7R		0.1 μ	±10, ±20	5	200	0.5±0.1		
MAASE105SB7102[FNA01	EMF105 B7102[VHF	16		X7R	1000 p	±10, ±20	2.5	200	0.5±0.05	
MAASE105SB7222[FNA01	EMF105 B7222[VHF			X7R	2200 p	±10, ±20	2.5	200	0.5±0.05	
MAASE105SB7472[FNA01	EMF105 B7472[VHF			X7R	4700 p	±10, ±20	2.5	200	0.5±0.05	
MAASE105SB7103[FNA01	EMF105 B7103[VHF			X7R	0.01 μ	±10, ±20	3.5	200	0.5±0.05	
MAASE105SB7223[FNA01	EMF105 B7223[VHF			X7R	0.022 μ	±10, ±20	3.5	200	0.5±0.05	
MAASE105SB7473[FNA01	EMF105 B7473[VHF			X7R	0.047 μ	±10, ±20	3.5	200	0.5±0.05	
MAASE105SB7104[FNA01	EMF105 B7104[VHF		X7R	0.1 μ	±10, ±20	5	150	0.5±0.05		
MAASE105SB7224[FCA01	EMR105 B7224[V-F		X7R	0.22 μ	±10, ±20	10	150	0.5±0.05		
MAASL105SB7102[FNA01	LMF105 B7102[VHF		10	X7R	1000 p	±10, ±20	2.5	200	0.5±0.05	
MAASL105SB7222[FNA01	LMF105 B7222[VHF			X7R	2200 p	±10, ±20	2.5	200	0.5±0.05	
MAASL105SB7472[FNA01	LMF105 B7472[VHF			X7R	4700 p	±10, ±20	2.5	200	0.5±0.05	
MAASL105SB7103[FNA01	LMF105 B7103[VHF			X7R	0.01 μ	±10, ±20	3.5	200	0.5±0.05	
MAASL105SB7223[FNA01	LMF105 B7223[VHF			X7R	0.022 μ	±10, ±20	3.5	200	0.5±0.05	
MAASL105SB7473[FNA01	LMF105 B7473[VHF			X7R	0.047 μ	±10, ±20	3.5	200	0.5±0.05	
MAASL105SB7104[FNA01	LMF105 B7104[VHF	X7R		0.1 μ	±10, ±20	5	200	0.5±0.05		
MAASL105SB7224[FCA01	LMR105 B7224[V-F	X7R		0.22 μ	±10, ±20	10	150	0.5±0.05		
MAASL105AD7474[FCA01	LMR105AD7474[V-F	X7T		0.47 μ	±10, ±20	10	150	0.5±0.1		
MAASJ105SB7224[FCA01	JMR105 B7224[V-F	6.3		X7R	0.22 μ	±10, ±20	10	150	0.5±0.05	
MAASJ105AD7474[FCA01	JMR105AD7474[V-F			X7T	0.47 μ	±10, ±20	10	150	0.5±0.1	
MAASJ105CD7105[FCA01	JMR105CD7105[V-F			X7T	1 μ	±10, ±20	10	150	0.5+0.2/-0	
MAASA105CD7105[FCA01	AMR105CD7105[V-F	4		X7T	1 μ	±10, ±20	10	200	0.5+0.2/-0	

▶ This catalog contains the typical specification only due to the limitation of space. When you consider the purchase of our products, please check our specification.
For details of each product (characteristics graph, reliability information, precautions for use, and so on), see our Web site (<http://www.ty-top.com/>).

■ PART NUMBER

● 1608TYPE

【Temperature Characteristic B7 : X7R(−55~+125°C), C7 : X7S(−55~+125°C)】 0.8mm Thickness

New part number	Old part number (for reference)	Rated voltage [V]	Temperature characteristics	Capacitance [F]	Capacitance tolerance [%]	tan δ [%]	HHLT		Thickness*1 [mm]	Note	
							Rated voltage x %				
MAASH168SB7102□TCA01	HMR107 B7102□A-T	100	X7R	1000 p	±10, ±20	3.5	200	0.8±0.10			
MAASH168SB7152□TCA01	HMR107 B7152□A-T		X7R	1500 p	±10, ±20	3.5	200	0.8±0.10			
MAASH168SB7222□TCA01	HMR107 B7222□A-T		X7R	2200 p	±10, ±20	3.5	200	0.8±0.10			
MAASH168SB7332□TCA01	HMR107 B7332□A-T		X7R	3300 p	±10, ±20	3.5	200	0.8±0.10			
MAASH168SB7472□TCA01	HMR107 B7472□A-T		X7R	4700 p	±10, ±20	3.5	200	0.8±0.10			
MAASH168SB7682□TCA01	HMR107 B7682□A-T		X7R	6800 p	±10, ±20	3.5	200	0.8±0.10			
MAASH168SB7103□TCA01	HMR107 B7103□A-T		X7R	0.01 μ	±10, ±20	3.5	200	0.8±0.10			
MAASH168SB7153□TCA01	HMR107 B7153□A-T		X7R	0.015 μ	±10, ±20	3.5	200	0.8±0.10			
MAASH168SB7223□TCA01	HMR107 B7223□A-T		X7R	0.022 μ	±10, ±20	3.5	200	0.8±0.10			
MAASH168SB7333□TCA01	HMR107 B7333□A-T		X7R	0.033 μ	±10, ±20	3.5	200	0.8±0.10			
MAASH168SB7473□TCA01	HMR107 B7473□A-T		X7R	0.047 μ	±10, ±20	3.5	200	0.8±0.10			
MAASH168AB7104□TCA01	HMR107AB7104□A-T		X7R	0.1 μ	±10, ±20	3.5	200	0.8±0.10			
MAASU168SB7223□TNA01	UMF107 B7223□AHT		50	X7R	0.022 μ	±10, ±20	3.5	200	0.8±0.10		
MAASU168SB7473□TNA01	UMF107 B7473□AHT			X7R	0.047 μ	±10, ±20	3.5	200	0.8±0.10		
MAASU168SB7104□TNA01	UMF107 B7104□AHT			X7R	0.1 μ	±10, ±20	3.5	200	0.8±0.10		
MAASU168AC7224□TCA01	UMR107AC7224□A-T			X7R	0.22 μ	±10, ±20	3.5	200	0.8+0.15/-0.05		
MAAST168SB7223□TNA01	TMF107 B7223□AHT			25	X7R	0.022 μ	±10, ±20	3.5	200	0.8±0.10	
MAAST168SB7473□TNA01	TMF107 B7473□AHT				X7R	0.047 μ	±10, ±20	3.5	200	0.8±0.10	
MAAST168SB7104□TNA01	TMF107 B7104□AHT				X7R	0.1 μ	±10, ±20	3.5	200	0.8±0.10	
MAAST168SB7224□TNA01	TMF107 B7224□AHT				X7R	0.22 μ	±10, ±20	10	150	0.8±0.10	
MAAST168SB7474□TNA01	TMF107 B7474□AHT	X7R			0.47 μ	±10, ±20	10	150	0.8±0.10		
MAAST168SB7105□TCA01	TMR107 B7105□A-T	X7R			1 μ	±10, ±20	10	150	0.8±0.10		
MAASE168SB7223□TNA01	EMF107 B7223□AHT	16	X7R		0.022 μ	±10, ±20	3.5	200	0.8±0.10		
MAASE168SB7473□TNA01	EMF107 B7473□AHT		X7R		0.047 μ	±10, ±20	3.5	200	0.8±0.10		
MAASE168SB7104□TNA01	EMF107 B7104□AHT		X7R		0.1 μ	±10, ±20	3.5	200	0.8±0.10		
MAASE168SB7224□TNA01	EMF107 B7224□AHT		X7R		0.22 μ	±10, ±20	5	200	0.8±0.10		
MAASE168SB7474□TNA01	EMF107 B7474□AHT		X7R	0.47 μ	±10, ±20	10	150	0.8±0.10			
MAASE168SB7105□TNA01	EMF107 B7105□AHT		X7R	1 μ	±10, ±20	10	150	0.8±0.10			
MAASL168SB7223□TNA01	LMF107 B7223□AHT		10	X7R	0.022 μ	±10, ±20	3.5	200	0.8±0.10		
MAASL168SB7473□TNA01	LMF107 B7473□AHT			X7R	0.047 μ	±10, ±20	3.5	200	0.8±0.10		
MAASL168SB7104□TNA01	LMF107 B7104□AHT			X7R	0.1 μ	±10, ±20	3.5	200	0.8±0.10		
MAASL168SB7224□TNA01	LMF107 B7224□AHT			X7R	0.22 μ	±10, ±20	5	200	0.8±0.10		
MAASL168SB7474□TNA01	LMF107 B7474□AHT	X7R		0.47 μ	±10, ±20	10	150	0.8±0.10			
MAASL168SB7105□TNA01	LMF107 B7105□AHT	X7R		1 μ	±10, ±20	10	150	0.8±0.10			
MAASJ168SB7225□TCA01	JMR107 B7225KA-T	6.3		X7R	2.2 μ	±10, ±20	10	150	0.8±0.10		

● 2012TYPE

【Temperature Characteristic B7 : X7R(−55~+125°C), C7 : X7S(−55~+125°C), D7 : X7T(−55~+125°C)】 1.25mm Thickness

New part number	Old part number (for reference)	Rated voltage [V]	Temperature characteristics	Capacitance [F]	Capacitance tolerance [%]	tan δ [%]	HHLT		Thickness*1 [mm]	Note	
							Rated voltage x %				
MAASH21GSB7103□TNA01	HMF212 B7103□GHT	100	X7R	0.01 μ	±10, ±20	3.5	200	1.25±0.10			
MAASH21GSB7223□TNA01	HMF212 B7223□GHT		X7R	0.022 μ	±10, ±20	3.5	200	1.25±0.10			
MAASH21GSB7473□TNA01	HMF212 B7473□GHT		X7R	0.047 μ	±10, ±20	3.5	200	1.25±0.10			
MAASH21GSB7104□TNA01	HMF212 B7104□GHT		X7R	0.1 μ	±10, ±20	3.5	200	1.25±0.10			
MAASH21GSB7224□TNA01	HMF212 B7224□GHT		X7R	0.22 μ	±10, ±20	3.5	200	1.25±0.10			
MAASH21GAC7474□TCA01	HMR212AC7474□G-T		X7S	0.47 μ	±10, ±20	3.5	150	1.25+0.15/-0.05			
MAASH21GCC7105□TCA01	HMR212CC7105□G-T		X7S	1 μ	±10, ±20	3.5	150	1.25+0.25/-0			
MAASU21GSB7103□TNA01	UMF212 B7103□GHT		50	X7R	0.01 μ	±10, ±20	3.5	200	1.25±0.10		
MAASU21GSB7223□TNA01	UMF212 B7223□GHT			X7R	0.022 μ	±10, ±20	3.5	200	1.25±0.10		
MAASU21GSB7473□TNA01	UMF212 B7473□GHT			X7R	0.047 μ	±10, ±20	3.5	200	1.25±0.10		
MAASU21GSB7104□TNA01	UMF212 B7104□GHT			X7R	0.1 μ	±10, ±20	3.5	200	1.25±0.10		
MAASU21GSB7224□TNA01	UMF212 B7224□GHT			X7R	0.22 μ	±10, ±20	3.5	200	1.25±0.10		
MAASU21GAC7474□TCA01	UMR212AC7474□G-T			X7S	0.47 μ	±10, ±20	3.5	200	1.25 +0.15/-0.05		
MAASU21GSB7105□TNA01	UMF212 B7105□GHT			X7R	1 μ	±10, ±20	10	150	1.25±0.10		
MAAST21GSB7103□TNA01	TMF212 B7103□GHT			25	X7R	0.01 μ	±10, ±20	3.5	200	1.25±0.10	
MAAST21GSB7223□TNA01	TMF212 B7223□GHT				X7R	0.022 μ	±10, ±20	3.5	200	1.25±0.10	
MAAST21GSB7473□TNA01	TMF212 B7473□GHT				X7R	0.047 μ	±10, ±20	3.5	200	1.25±0.10	
MAAST21GSB7104□TNA01	TMF212 B7104□GHT		X7R		0.1 μ	±10, ±20	3.5	200	1.25±0.10		
MAAST21GSB7224□TNA01	TMF212 B7224□GHT		X7R		0.22 μ	±10, ±20	3.5	200	1.25±0.10		
MAAST21GSB7474□TNA01	TMF212 B7474□GHT		X7R		0.47 μ	±10, ±20	3.5	200	1.25±0.10		
MAAST21GSB7105□TNA01	TMF212 B7105□GHT	X7R	1 μ		±10, ±20	10	200	1.25±0.10			
MAAST21GSB7225□TNA01	TMF212 B7225□GHT	X7R	2.2 μ		±10, ±20	10	150	1.25±0.10			
MAASE21GSB7473□TNA01	EMF212 B7473□GHT	16	X7R		0.047 μ	±10, ±20	3.5	200	1.25±0.10		
MAASE21GSB7104□TNA01	EMF212 B7104□GHT		X7R		0.1 μ	±10, ±20	3.5	200	1.25±0.10		
MAASE21GSB7224□TNA01	EMF212 B7224□GHT		X7R	0.22 μ	±10, ±20	3.5	200	1.25±0.10			
MAASE21GSB7474□TNA01	EMF212 B7474□GHT		X7R	0.47 μ	±10, ±20	3.5	200	1.25±0.10			
MAASE21GSB7105□TNA01	EMF212 B7105□GHT		X7R	1 μ	±10, ±20	10	200	1.25±0.10			
MAASE21GSB7225□TNA01	EMF212 B7225□GHT		X7R	2.2 μ	±10, ±20	10	200	1.25±0.10			
MAASE21GAB7475□TNA01	EMF212AB7475□GHT		X7R	4.7 μ	±10, ±20	10	150	1.25+0.15/-0.05			
MAASL21GSB7473□TNA01	LMF212 B7473□GHT		10	X7R	0.047 μ	±10, ±20	3.5	200	1.25±0.10		
MAASL21GSB7104□TNA01	LMF212 B7104□GHT			X7R	0.1 μ	±10, ±20	3.5	200	1.25±0.10		
MAASL21GSB7224□TNA01	LMF212 B7224□GHT			X7R	0.22 μ	±10, ±20	3.5	200	1.25±0.10		
MAASL21GSB7474□TNA01	LMF212 B7474□GHT	X7R		0.47 μ	±10, ±20	3.5	200	1.25±0.10			
MAASL21GSB7105□TNA01	LMF212 B7105□GHT	X7R		1 μ	±10, ±20	10	200	1.25±0.10			
MAASL21GSB7225□TNA01	LMF212 B7225□GHT	X7R		2.2 μ	±10, ±20	10	200	1.25±0.10			
MAASL21GSB7475□TNA01	LMF212 B7475□GHT	X7R		4.7 μ	±10, ±20	10	150	1.25±0.10			
MAASL21GBD7106□TCA01	LMR212BD7106□G-T	X7T		10 μ	±10, ±20	10	150	1.25+0.2/-0			
MAASJ21GAB7106□TNA01	JMF212AB7106□GHT	6.3		X7R	10 μ	±10, ±20	10	150	1.25+0.15/-0.05		

▶ This catalog contains the typical specification only due to the limitation of space. When you consider the purchase of our products, please check our specification. For details of each product (characteristics graph, reliability information, precautions for use, and so on), see our Web site (<http://www.ty-top.com/>).

PART NUMBER

3216TYPE

【Temperature Characteristic B7 : X7R(−55~+125°C)】 1.15mm Thickness

New part number	Old part number (for reference)	Rated voltage [V]	Temperature characteristics	Capacitance [F]	Capacitance tolerance [%]	tan δ [%]	HTLT	Thickness*1 [mm]	Note
							Rated voltage x %		
MAASH31QHB7102□TNA01	HMF316 B7102□FHT	100	X7R	1000 p	±10, ±20	2.5	200	1.15±0.10	
MAASH31QHB7222□TNA01	HMF316 B7222□FHT		X7R	2200 p	±10, ±20	2.5	200	1.15±0.10	
MAASH31QHB7472□TNA01	HMF316 B7472□FHT		X7R	4700 p	±10, ±20	2.5	200	1.15±0.10	
MAASH31QHB7103□TNA01	HMF316 B7103□FHT		X7R	0.01 μ	±10, ±20	2.5	200	1.15±0.10	
MAASU31QHB7102□TNA01	UMF316 B7102□FHT	50	X7R	1000 p	±10, ±20	2.5	200	1.15±0.10	
MAASU31QHB7222□TNA01	UMF316 B7222□FHT		X7R	2200 p	±10, ±20	2.5	200	1.15±0.10	
MAASU31QHB7472□TNA01	UMF316 B7472□FHT		X7R	4700 p	±10, ±20	2.5	200	1.15±0.10	
MAASU31QHB7103□TNA01	UMF316 B7103□FHT		X7R	0.01 μ	±10, ±20	2.5	200	1.15±0.10	

【Temperature Characteristic B7 : X7R(−55~+125°C), C7 : X7S(−55~+125°C)】 1.6mm Thickness

New part number	Old part number (for reference)	Rated voltage [V]	Temperature characteristics	Capacitance [F]	Capacitance tolerance [%]	tan δ [%]	HTLT	Thickness*1 [mm]	Note
							Rated voltage x %		
MAASH31LSB7104□TNA01	HMF316 B7104□LHT	100	X7R	0.1 μ	±10, ±20	3.5	200	1.6±0.20	
MAASH31LSB7224□TNA01	HMF316 B7224□LHT		X7R	0.22 μ	±10, ±20	3.5	150	1.6±0.20	
MAASH31LSB7474□TNA01	HMF316 B7474□LHT		X7R	0.47 μ	±10, ±20	3.5	150	1.6±0.20	
MAASH31LSB7105□TCA01	HMR316 B7105□L-T		X7R	1 μ	±10, ±20	3.5	150	1.6±0.20	
MAASH31LBC7225□TCA01	HMR316BC7225□L-T	50	X7S	2.2 μ	±10, ±20	3.5	150	1.6±0.30	
MAASU31LSB7104□TNA01	UMF316 B7104□LHT		X7R	0.1 μ	±10, ±20	3.5	200	1.6±0.20	
MAASU31LSB7224□TNA01	UMF316 B7224□LHT		X7R	0.22 μ	±10, ±20	3.5	200	1.6±0.20	
MAASU31LSB7474□TNA01	UMF316 B7474□LHT		X7R	0.47 μ	±10, ±20	3.5	200	1.6±0.20	
MAASU31LSB7105□TNA01	UMF316 B7105□LHT	25	X7R	1 μ	±10, ±20	3.5	150	1.6±0.20	
MAASU31LBC7225□TCA01	UMR316BC7225□L-T		X7S	2.2 μ	±10, ±20	3.5	150	1.6±0.30	
MAASU31LBC7475□TCA01	UMR316BC7475□L-T		X7S	4.7 μ	±10, ±20	3.5	150	1.6±0.30	
MAAST31LSB7104□TNA01	TMF316 B7104□LHT		X7R	0.1 μ	±10, ±20	3.5	200	1.6±0.20	
MAAST31LSB7224□TNA01	TMF316 B7224□LHT	16	X7R	0.22 μ	±10, ±20	3.5	200	1.6±0.20	
MAAST31LSB7474□TNA01	TMF316 B7474□LHT		X7R	0.47 μ	±10, ±20	3.5	200	1.6±0.20	
MAAST31LSB7105□TNA01	TMF316 B7105□LHT		X7R	1 μ	±10, ±20	3.5	200	1.6±0.20	
MAAST31LSB7225□TNA01	TMF316 B7225□LHT		X7R	2.2 μ	±10, ±20	3.5	200	1.6±0.20	
MAAST31LAB7475□TNA01	TMF316AB7475□LHT	10	X7R	4.7 μ	±10, ±20	10	150	1.6±0.20	
MAASE31LSB7224□TNA01	EMF316 B7224□LHT		X7R	0.22 μ	±10, ±20	3.5	200	1.6±0.20	
MAASE31LSB7474□TNA01	EMF316 B7474□LHT		X7R	0.47 μ	±10, ±20	3.5	200	1.6±0.20	
MAASE31LSB7105□TNA01	EMF316 B7105□LHT		X7R	1 μ	±10, ±20	3.5	200	1.6±0.20	
MAASE31LSB7225□TNA01	EMF316 B7225□LHT	6.3	X7R	2.2 μ	±10, ±20	3.5	200	1.6±0.20	
MAASE31LAB7475□TNA01	EMF316AB7475□LHT		X7R	4.7 μ	±10, ±20	10	200	1.6±0.20	
MAASE31LAB7106□TNA01	EMF316AB7106□LHT		X7R	10 μ	±10, ±20	10	150	1.6±0.20	
MAASL31LSB7224□TNA01	LMF316 B7224□LHT		X7R	0.22 μ	±10, ±20	3.5	200	1.6±0.20	
MAASL31LSB7474□TNA01	LMF316 B7474□LHT	10	X7R	0.47 μ	±10, ±20	3.5	200	1.6±0.20	
MAASL31LSB7105□TNA01	LMF316 B7105□LHT		X7R	1 μ	±10, ±20	3.5	200	1.6±0.20	
MAASL31LSB7225□TNA01	LMF316 B7225□LHT		X7R	2.2 μ	±10, ±20	3.5	200	1.6±0.20	
MAASL31LAB7475□TNA01	LMF316AB7475□LHT		X7R	4.7 μ	±10, ±20	10	200	1.6±0.20	
MAASL31LAB7106□TNA01	LMF316AB7106□LHT	6.3	X7R	10 μ	±10, ±20	10	150	1.6±0.20	
MAASJ31LAB7106□TNA01	JMF316AB7106□LHT		X7R	10 μ	±10, ±20	10	200	1.6±0.20	

3225TYPE

【Temperature Characteristic B7 : X7R(−55~+125°C), C7 : X7S(−55~+125°C)】 2.5mm Thickness

New part number	Old part number (for reference)	Rated voltage [V]	Temperature characteristics	Capacitance [F]	Capacitance tolerance [%]	tan δ [%]	HTLT	Thickness*1 [mm]	Note
							Rated voltage x %		
MAASH32MSB7225□PNA01	HMF325 B7225□MHP	100	X7R	2.2 μ	±10, ±20	3.5	150	2.5±0.20	
MAASH32MAC7475□PCA01	HMR325AC7475□M-P		X7S	4.7 μ	±10, ±20	3.5	150	2.5±0.30	
MAASU32MSB7225□PNA01	UMF325 B7225□MHP	50	X7R	2.2 μ	±10, ±20	3.5	200	2.5±0.20	
MAASU32MSB7475□PNA01	UMF325 B7475□MHP		X7R	4.7 μ	±10, ±20	5	150	2.5±0.20	
MAASU32MAC7106□PCA01	UMR325AC7106□M-P	25	X7S	10 μ	±10, ±20	3.5	150	2.5±0.30	
MAAST32MSB7225□PNA01	TMF325 B7225□MHP		X7R	2.2 μ	±10, ±20	3.5	200	2.5±0.20	
MAAST32MSB7475□PNA01	TMF325 B7475□MHP	16	X7R	4.7 μ	±10, ±20	5	200	2.5±0.20	
MAAST32MSB7106□PNA01	TMF325 B7106□MHP		X7R	10 μ	±10, ±20	10	150	2.5±0.20	
MAASE32MSB7225□PNA01	EMF325 B7225□MHP	10	X7R	2.2 μ	±10, ±20	3.5	200	2.5±0.20	
MAASE32MSB7475□PNA01	EMF325 B7475□MHP		X7R	4.7 μ	±10, ±20	5	200	2.5±0.20	
MAASE32MSB7106□PNA01	EMF325 B7106□MHP	6.3	X7R	10 μ	±10, ±20	10	200	2.5±0.20	
MAASL32MSB7225□PNA01	LMF325 B7225□MHP		X7R	2.2 μ	±10, ±20	3.5	200	2.5±0.20	
MAASL32MSB7475□PNA01	LMF325 B7475□MHP	6.3	X7R	4.7 μ	±10, ±20	5	200	2.5±0.20	
MAASL32MSB7106□PNA01	LMF325 B7106□MHP		X7R	10 μ	±10, ±20	10	200	2.5±0.20	

▶ This catalog contains the typical specification only due to the limitation of space. When you consider the purchase of our products, please check our specification.
For details of each product (characteristics graph, reliability information, precautions for use, and so on), see our Web site (<http://www.ty-top.com/>).

PART NUMBER

【Temperature Characteristic B7 : X7R (−55~+125°C)】 1.9mm Thickness

New part number	Old part number (for reference)	Rated voltage [V]	Temperature characteristics	Capacitance [F]	Capacitance tolerance [%]	tan δ [%]	HTLT	Thickness*1 [mm]	Note
							Rated voltage x %		
MAASH32NSB7223□TNA01	HMF325 B7223□NHT	100	X7R	0.022 μ	±10, ±20	2.5	200	1.9±0.20	
MAASH32NSB7473□TNA01	HMF325 B7473□NHT		X7R	0.047 μ	±10, ±20	2.5	200	1.9±0.20	
MAASH32NSB7104□TNA01	HMF325 B7104□NHT		X7R	0.1 μ	±10, ±20	3.5	200	1.9±0.20	
MAASH32NSB7224□TNA01	HMF325 B7224□NHT		X7R	0.22 μ	±10, ±20	3.5	200	1.9±0.20	
MAASU32NSB7223□TNA01	UMF325 B7223□NHT	50	X7R	0.022 μ	±10, ±20	2.5	200	1.9±0.20	
MAASU32NSB7473□TNA01	UMF325 B7473□NHT		X7R	0.047 μ	±10, ±20	2.5	200	1.9±0.20	
MAASU32NSB7104□TNA01	UMF325 B7104□NHT		X7R	0.1 μ	±10, ±20	3.5	200	1.9±0.20	
MAASU32NSB7224□TNA01	UMF325 B7224□NHT		X7R	0.22 μ	±10, ±20	3.5	200	1.9±0.20	
MAASU32NSB7474□TNA01	UMF325 B7474□NHT	25	X7R	0.47 μ	±10, ±20	3.5	200	1.9±0.20	
MAASU32NSB7105□TNA01	UMF325 B7105□NHT		X7R	1 μ	±10, ±20	3.5	200	1.9±0.20	
MAAST32NSB7224□TNA01	TMF325 B7224□NHT		X7R	0.22 μ	±10, ±20	3.5	200	1.9±0.20	
MAAST32NSB7474□TNA01	TMF325 B7474□NHT		X7R	0.47 μ	±10, ±20	3.5	200	1.9±0.20	
MAAST32NSB7105□TNA01	TMF325 B7105□NHT	16	X7R	1 μ	±10, ±20	3.5	200	1.9±0.20	
MAASE32NSB7224□TNA01	EMF325 B7224□NHT		X7R	0.22 μ	±10, ±20	3.5	200	1.9±0.20	
MAASE32NSB7474□TNA01	EMF325 B7474□NHT		X7R	0.47 μ	±10, ±20	3.5	200	1.9±0.20	
MAASE32NSB7105□TNA01	EMF325 B7105□NHT	10	X7R	1 μ	±10, ±20	3.5	200	1.9±0.20	
MAASL32NSB7224□TNA01	LMF325 B7224□NHT		X7R	0.22 μ	±10, ±20	3.5	200	1.9±0.20	
MAASL32NSB7474□TNA01	LMF325 B7474□NHT		X7R	0.47 μ	±10, ±20	3.5	200	1.9±0.20	
MAASL32NSB7105□TNA01	LMF325 B7105□NHT		X7R	1 μ	±10, ±20	3.5	200	1.9±0.20	

► This catalog contains the typical specification only due to the limitation of space. When you consider the purchase of our products, please check our specification.
For details of each product (characteristics graph, reliability information, precautions for use, and so on), see our Web site (<http://www.ty-top.com/>).

Multilayer Ceramic Capacitors

PACKAGING

① Minimum Quantity

● Taped package

Type			Thickness		Standard Quantity [pcs]	
Code	JIS(mm)	EIA(inch)	[mm]	Code	Paper tape	Embossed tape
02	0201	008004	0.125	1	—	50000
04	0402	01005	0.2	2	—	40000
06	0603	0201	0.3	3	15000	—
1L	1005	0402	0.13	H	—	20000
			0.18	E	—	15000
			0.2	2	20000	—
			0.3	3	15000	—
10	1005	0402	0.5	5	10000	—
	0510 ※	0204	0.3	3	10000	—
16	1608	0603	0.45	K	4000	—
			0.7	7		
			0.8	8		
			0.8	8	3000 (Soft Termination)	3000 (Soft Termination)
	0816 ※	0306	0.5	5	—	4000
21	2012	0805	0.85	9	4000	—
			1.25	G	—	3000
			1.25	G	—	2000 (Soft Termination)
1220 ※	0508	0.85	9	4000	—	
31	3216	1206	0.85	9	4000	—
			1.15	Q	—	3000
			1.6	L	—	2000
32	3225	1210	0.85	9	—	2000
			1.15	Q		
			1.9	N		
			2.0 max	Y		
			2.5	M	—	500(T), 1000(P)
45	4532	1812	2.0 max	Y	—	1000
			2.5	M	—	500

注: ※LW Reverse type (MSRL, MCRL, MBRL, MLRL, MMRL)

② Taping material

※ No bottom tape for pressed carrier tape

- Card board carrier tape
- Embossed tape

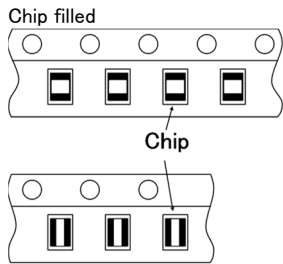
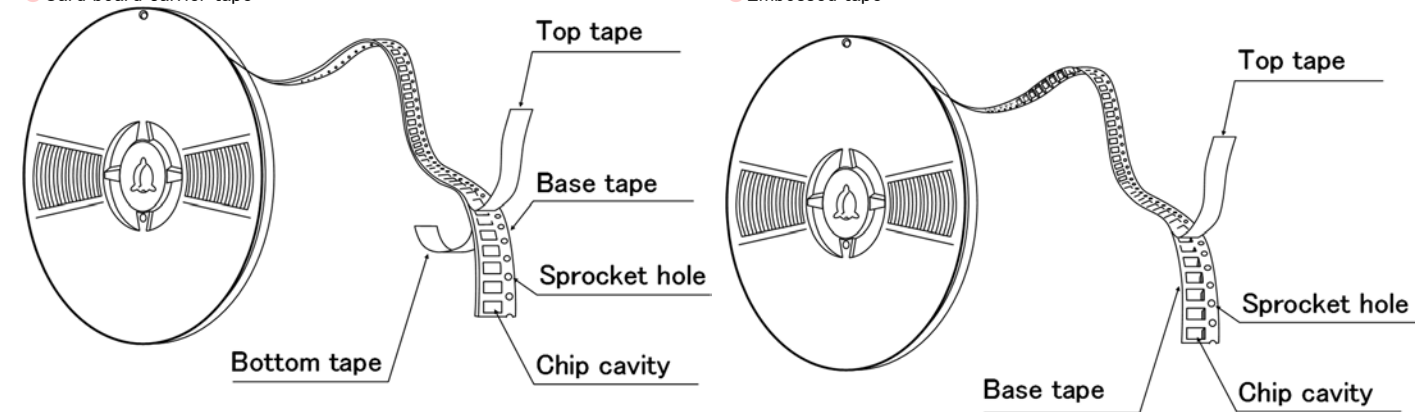

※ LW Reverse type.

③ Representative taping dimensions

● Paper Tape (8mm wide)

● Pressed carrier tape (2mm pitch)

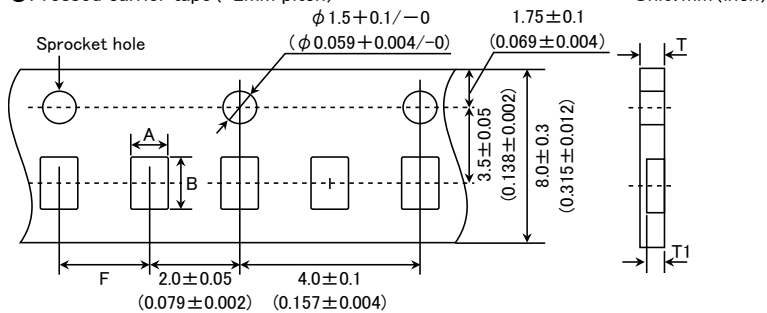

Type(EIA)	Chip Cavity		Insertion Pitch F	Tape Thickness	
	A	B		T	T1
0603 (0201)	0.37	0.67	2.0±0.05	0.45max.	0.42max.
0510 (0204) ※	0.65	1.15		0.4max.	0.3max.
1005 (0402) (*1 2)				0.45max.	0.42max.
1005 (0402) (*1 3)					

Note *1 Thickness, 2:0.2mm, 3:0.3mm. ※ LW Reverse type.

Unit: mm

● Punched carrier tape (2mm pitch)

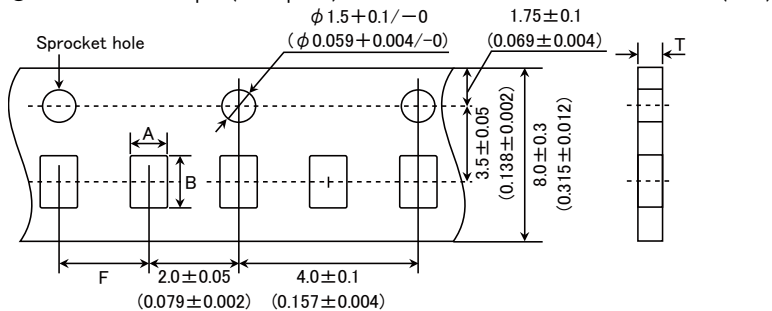

Type(EIA)	Chip Cavity		Insertion Pitch F	Tape Thickness
	A	B		T
1005 (0402)	0.65	1.15	2.0±0.05	0.8max.

Unit: mm

▶ This catalog contains the typical specification only due to the limitation of space. When you consider the purchase of our products, please check our specification. For details of each product (characteristics graph, reliability information, precautions for use, and so on), see our Web site (<http://www.ty-top.com/>).

● Punched carrier tape (4mm pitch)

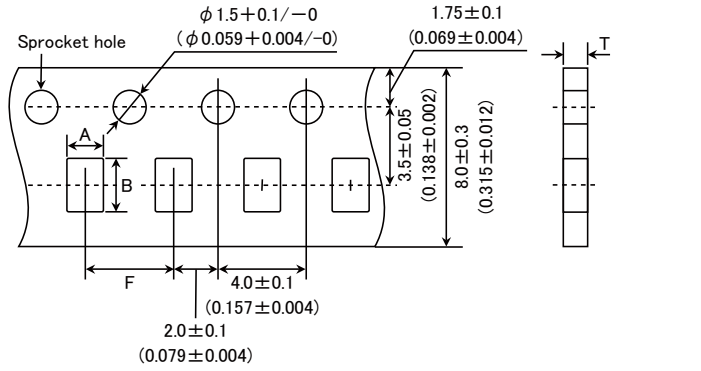

Type(EIA)	Chip Cavity		Insertion Pitch F	Tape Thickness	
	A	B		K	T
1608 (0603)	1.0	1.8	4.0 ± 0.1	1.1max.	1.1max.
0816 (0306) ※					
2012 (0805)					
1220 (0508) ※	1.65	2.4	4.0 ± 0.1	1.1max.	1.1max.
3216 (1206)	2.0	3.6			

Note: Taping size might be different depending on the size of the product. ※ LW Reverse type.

Unit: mm

● Embossed tape (4mm wide)

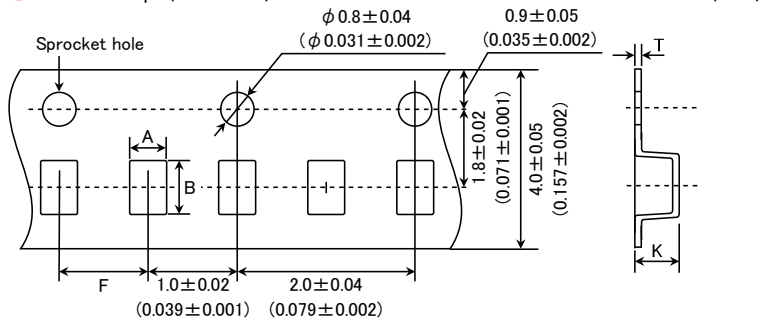

Type(EIA)	Chip Cavity		Insertion Pitch F	Tape Thickness	
	A	B		K	T
0201 (008004)	0.135	0.27	1.0 ± 0.02	0.5max.	0.25max.
0402 (01005)	0.23	0.43			

Unit: mm

● Embossed tape (8mm wide)

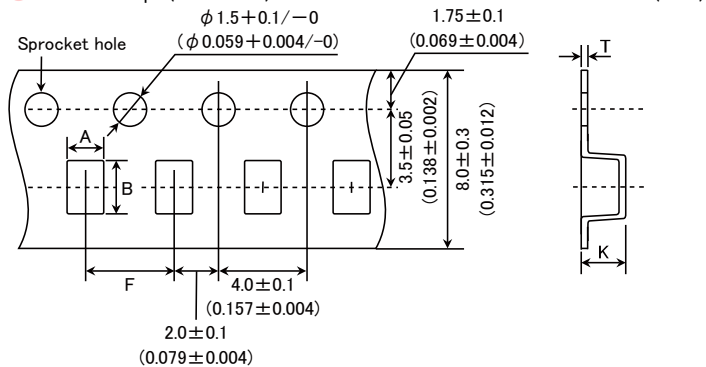

Type(EIA)	Chip Cavity		Insertion Pitch F	Tape Thickness	
	A	B		K	T
1005 (0402)	0.6	1.1	2.0 ± 0.1	0.6max	0.2 ± 0.1
0816 (0306) ※	1.0	1.8	4.0 ± 0.1	1.3max.	0.25 ± 0.1
2012 (0805)	1.65	2.4			
3216 (1206)	2.0	3.6			
3225 (1210)	2.8	3.6		3.4max.	0.6max.

Note: ※ LW Reverse type.

Unit: mm

► This catalog contains the typical specification only due to the limitation of space. When you consider the purchase of our products, please check our specification. For details of each product (characteristics graph, reliability information, precautions for use, and so on), see our Web site (<http://www.ty-top.com/>).

● Embossed tape (12mm wide) Unit: mm (inch)

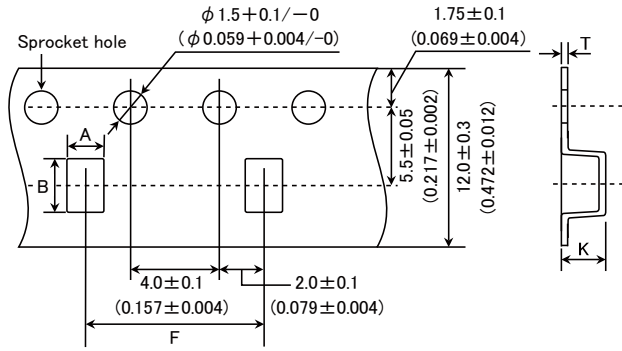

Type(EIA)	Chip Cavity		Insertion Pitch	Tape Thickness	
	A	B		K	T
3225 (1210)	3.1	4.0	8.0 ± 0.1	4.0max.	0.6max.
4532 (1812)	3.7	4.9	8.0 ± 0.1	4.0max.	0.6max.

Unit: mm

④ Trailer and Leader

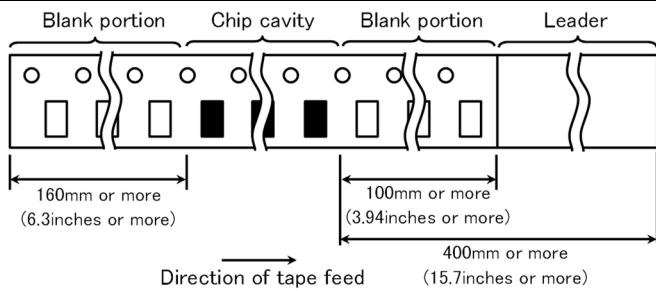

⑤ Reel size

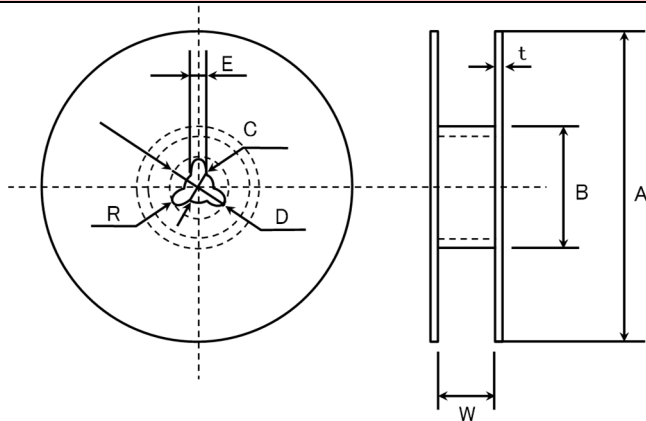

A	B	C	D	E	R
$\phi 178 \pm 2.0$	$\phi 50 \text{min.}$	$\phi 13.0 \pm 0.2$	$\phi 21.0 \pm 0.8$	2.0 ± 0.5	1.0

	T	W
4mm wide tape	1.5max.	5 ± 1.0
8mm wide tape	2.5max.	10 ± 1.5
12mm wide tape	2.5max.	14 ± 1.5

Unit: mm

⑥ Top Tape Strength

The top tape requires a peel-off force of 0.1 to 0.7N in the direction of the arrow as illustrated below.

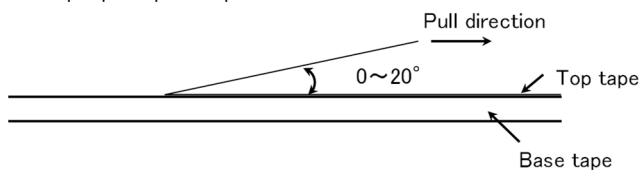

▶ This catalog contains the typical specification only due to the limitation of space. When you consider the purchase of our products, please check our specification. For details of each product (characteristics graph, reliability information, precautions for use, and so on), see our Web site (<http://www.ty-top.com/>).

Multilayer Ceramic Capacitors for Automotive Powertrain and Safety

■ RELIABILITY DATA

1. Operating Temperature Range	
Specified Value	X7R, X7S, X7T (−55°C to +125°C)
Test Methods and Remarks	Continuous use is available in this range. (reference temperature : 25°C)
2. Highest Operating temperature Range	
Specified Value	X7R, X7S, X7T (−55°C to +125°C)
Test Methods and Remarks	Maximum operating temperature at which capacitors can be continuously used with rated voltage applied.
3. Rated Voltage	
Specified Value	Please refer to the page of the "PART NUMBERS".
Test Methods and Remarks	Continuous maximum applied voltage. If an AC voltage is loaded on a DC voltage, the sum of the two peak voltages should be lower than the rated voltage of the capacitor.
4. Shape and Dimensions	
Specified Value	Please refer to the page of the "EXTERNAL DIMENSIONS".
5. Heat Treatment	
Test Methods and Remarks	Initial value shall be measured after test sample is heat-treated at 150+0/−10°C for an hour and kept at room temperature for 24 ± 2 hours.
6. Dielectric Withstanding Voltage (between terminals)	
Specified Value	No abnormality.
Test Methods and Remarks	Applied voltage : Rated voltage × 2.5 Duration : 1 to 5 seconds. Charging and discharging current shall be 50mA max.
7. Insulation Resistance	
Specified Value Note 1	Larger than whichever smaller of 500 MΩ · μF or 10000 MΩ
Test Methods and Remarks	Applied voltage : Rated voltage Duration : 60 ± 5 seconds. Charging and discharging current shall be 50mA max.
8. Capacitance and Tolerance	
Specified Value	±10% or ±20%
Test Methods and Remarks	Measurement frequency : 1kHz ± 10% (C ≤ 10 μF) Measurement voltage : 1 ± 0.2Vrms (C ≤ 10 μF) 0.5 ± 0.1V (6.3V rated voltage) Note 1
9. Dissipation factor (tan δ)	
Specified Value	Please refer to the page of the "PART NUMBERS".
Test Methods and Remarks	Measurement frequency : 1kHz ± 10% (C ≤ 10 μF) Measurement voltage : 1 ± 0.2Vrms (C ≤ 10 μF) 0.5 ± 0.1V (6.3V rated voltage) Note 1

► This catalog contains the typical specification only due to the limitation of space. When you consider the purchase of our products, please check our specification. For details of each product (characteristics graph, reliability information, precautions for use, and so on), see our Web site (<http://www.ty-top.com/>).

10. Temperature Characteristic (without DC bias)

Specified Value	X7R($\pm 15\%$), X7S($\pm 22\%$), X7T(+ 22%/- 33%)												
Test Methods and Remarks	Heat treatment specified in No.5 of the specification shall be conducted prior to test. Change of the maximum capacitance deviation in step 1 to 5.												
	<table border="1"> <thead> <tr> <th>step</th> <th>Temperature($^{\circ}\text{C}$)</th> </tr> </thead> <tbody> <tr> <td>1</td> <td>+25</td> </tr> <tr> <td>2</td> <td>Minimum operating temperature</td> </tr> <tr> <td>3</td> <td>+25</td> </tr> <tr> <td>4</td> <td>Maximum operating temperature</td> </tr> <tr> <td>5</td> <td>+25</td> </tr> </tbody> </table>	step	Temperature($^{\circ}\text{C}$)	1	+25	2	Minimum operating temperature	3	+25	4	Maximum operating temperature	5	+25
	step	Temperature($^{\circ}\text{C}$)											
	1	+25											
	2	Minimum operating temperature											
	3	+25											
4	Maximum operating temperature												
5	+25												

11. Adhesive Force of Terminal Electrodes

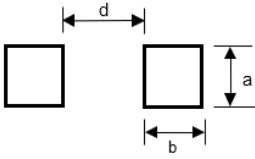
Specified Value	Appearance: Terminal electrodes shall be no exfoliation or a sign of exfoliation.																																				
Test Methods and Remarks	<table border="1"> <thead> <tr> <th></th> <th>0603 size</th> <th>1005 size</th> <th>larger than 1608 size</th> </tr> </thead> <tbody> <tr> <td>Applying force</td> <td>2N</td> <td>5N</td> <td>17.7N</td> </tr> <tr> <td>Duration</td> <td colspan="3">60\pm1 seconds.</td> </tr> <tr> <td>Board</td> <td colspan="3">Glass epoxy-resin substrate</td> </tr> </tbody> </table>		0603 size	1005 size	larger than 1608 size	Applying force	2N	5N	17.7N	Duration	60 \pm 1 seconds.			Board	Glass epoxy-resin substrate																						
		0603 size	1005 size	larger than 1608 size																																	
	Applying force	2N	5N	17.7N																																	
	Duration	60 \pm 1 seconds.																																			
	Board	Glass epoxy-resin substrate																																			
		Solder lands refer to fig.1.																																			
		<table border="1"> <thead> <tr> <th rowspan="2">Dimension</th> <th colspan="6">Case size</th> </tr> <tr> <th>0603</th> <th>1005</th> <th>1608</th> <th>2012</th> <th>3216</th> <th>3225</th> </tr> </thead> <tbody> <tr> <td>a</td> <td>0.4</td> <td>0.5</td> <td>1.2</td> <td>1.65</td> <td>2.0</td> <td>2.9</td> </tr> <tr> <td>b</td> <td>0.3</td> <td>0.55</td> <td>1.0</td> <td>1.4</td> <td>1.4</td> <td>1.4</td> </tr> <tr> <td>d</td> <td>0.3</td> <td>0.4</td> <td>1.0</td> <td>1.2</td> <td>2.2</td> <td>2.2</td> </tr> </tbody> </table>	Dimension	Case size						0603	1005	1608	2012	3216	3225	a	0.4	0.5	1.2	1.65	2.0	2.9	b	0.3	0.55	1.0	1.4	1.4	1.4	d	0.3	0.4	1.0	1.2	2.2	2.2	
Dimension	Case size																																				
	0603	1005	1608	2012	3216	3225																															
a	0.4	0.5	1.2	1.65	2.0	2.9																															
b	0.3	0.55	1.0	1.4	1.4	1.4																															
d	0.3	0.4	1.0	1.2	2.2	2.2																															
	Fig.1																																				

12. Vibration

Specified Value	Appearance : No abnormality Capacitance change : Initial value shall be satisfied. Dissipation factor : Initial value shall be satisfied. Insulation resistance : Initial value shall be satisfied.
Test Methods and Remarks	Heat treatment specified in No.5 of the specification shall be conducted prior to test. Solder lands refer to figure 1. Direction of the vibration test : X, Y, Z each of 3 orientations for 12 times respectively (Total 36 times) Vibration frequency : 10 to 2000 to 10Hz (20 minutes each) Total amplitude : 1.5 mm Measurement shall be performed after test sample following the test is heated at 150+0/-10 $^{\circ}\text{C}$ for an hour and kept at room temperature for 24 \pm 2 hrs. No.5

13. Solderability

Specified Value	More than 95% of terminal electrode shall be covered with fresh solder.
Test Methods and Remarks	Immerse test sample in an solder solution (Sn-3Ag-0.5Cu). Soldering temperature : 245 $^{\circ}\text{C}$ \pm 3 $^{\circ}\text{C}$ Duration : 3 \pm 1 seconds

14. Resistance to Soldering Heat

Specified Value Note 1	Appearance : No abnormality Capacitance change : $\leq \pm 7.5\%$ Dissipation factor : Initial value shall be satisfied. Insulation resistance : Initial value shall be satisfied. Dielectric withstanding voltage (between terminals) : No abnormality
Test Methods and Remarks	Heat treatment specified in No.5 of the specification shall be conducted prior to test. Immerse test sample in an solder solution (Sn-3Ag-0.5Cu). Soldering temperature : 260 $^{\circ}\text{C}$ \pm 5 $^{\circ}\text{C}$ Duration : 10 \pm 1 seconds Soaking position : Test sample is soaked until the terminal electrode is covered in solder solution. Measurement shall be performed after test sample following the test is heated at 150+0/-10 $^{\circ}\text{C}$ for an hour and kept at room temperature for 24 \pm 2 hrs. No.5

15. Temperature Cycling

Specified Value Note 1	Appearance : No abnormality Capacitance change : $\leq \pm 7.5\%$ Dissipation factor : Initial value shall be satisfied. Insulation resistance : Initial value shall be satisfied.															
Test Methods and Remarks	Heat treatment specified in No.5 of the specification shall be conducted prior to test. condition of the one cycle <table border="1"> <thead> <tr> <th>Step</th> <th>Temperature (°C)</th> <th>Time (min.)</th> </tr> </thead> <tbody> <tr> <td>1</td> <td>Minimum usage temperature</td> <td>30±3</td> </tr> <tr> <td>2</td> <td>+25</td> <td>2 to 3</td> </tr> <tr> <td>3</td> <td>Maximum usage temperature</td> <td>30±3</td> </tr> <tr> <td>4</td> <td>+25</td> <td>2 to 3</td> </tr> </tbody> </table> <p>Test cycles: 1000 times Solder lands refer to fig. 2. Measurement shall be performed after test sample following the test is heated at 150+0/-10°C for an hour and kept at room temperature for 24±2 hrs. No.5</p>	Step	Temperature (°C)	Time (min.)	1	Minimum usage temperature	30±3	2	+25	2 to 3	3	Maximum usage temperature	30±3	4	+25	2 to 3
Step	Temperature (°C)	Time (min.)														
1	Minimum usage temperature	30±3														
2	+25	2 to 3														
3	Maximum usage temperature	30±3														
4	+25	2 to 3														

16. High Temperature Loading

Specified Value Note 1	Appearance : No abnormality Capacitance change : $\leq \pm 12.5\%$ Dissipation factor : 5.0%max. Insulation resistance : Larger than whichever smaller of 50MΩ · μF or 1000MΩ
Test Methods and Remarks	Heat treatment specified in No.5 of the specification shall be conducted prior to test. Temperature : Maximum usage temperature Duration : 1000 +48/-0 hours. Applied voltage : Applied rated voltage. Charging and discharging current : 50mA max Measurement shall be performed after test sample following the test is heated at 150+0/-10°C for an hour and kept at room temperature for 24±2 hrs. No.5

17. Humidity Loading

Specified Value Note 1	Appearance : No abnormality Capacitance change : $\leq \pm 12.5\%$ Dissipation factor : 5.0%max. Insulation resistance : Larger than whichever smaller of 25MΩ · μF or 500MΩ
Test Methods and Remarks	Heat treatment specified in No.5 of the specification shall be conducted prior to test. Temperature : 85°C Humidity : 85%RH Duration : 1000 +48/-0 hours. Applied voltage : Applied rated voltage. (Add 100kΩ resistor) Measurement shall be performed after test sample following the test is heated at 150+0/-10°C for an hour and kept at room temperature for 24±2 hrs. No.5

18. Resistance to Flexure of substrate

Specified Value Note 1	Appearance	: No abnormality
	Capacitance change	: $\leq \pm 7.5\%$
	Dissipation factor	: Initial value shall be satisfied.
	Insulation resistance	: Initial value shall be satisfied.

Test Methods and Remarks	Warp	: 2mm for 60 seconds
	Testing board	: Grass epoxy - resin substrate
	Test board and solder lands	: Refer to fig. 2 and fig.3.

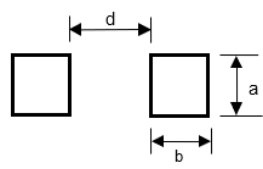

Dimension	Case size					
	0603	1005	1608	2012	3216	3225
a	0.3	0.5	0.9	1.3	1.7	2.6
b	0.3	0.55	0.8	1.1	1.2	1.2
d	0.3	0.4	0.6	0.8	2.0	2.0
t	0.8	1.6				

Fig.2

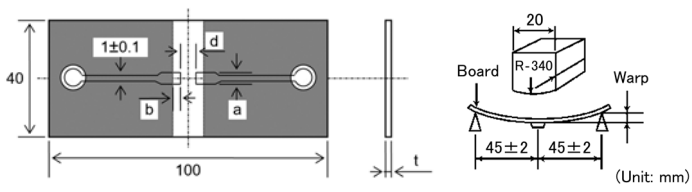

Fig.3 Capacitance measurement shall be conducted with the board bent.

19. High Temperature Exposure

Specified Value Note1	Appearance	: No abnormality
	Capacitance change	: $\leq \pm 7.5\%$
	Dissipation factor	: Initial value shall be satisfied.
	Insulation resistance	: Initial value shall be satisfied.

Test Methods and Remarks	Heat treatment specified in No.5 of the specification shall be conducted prior to test.	
	Temperature	: Maximum usage temperature
	Duration	: 1000+48/-0 hours.
	Measurement shall be performed after test sample following the test is heated at 150+0/-10°C for an hour and kept at room temperature for 24±2 hrs. No.5	

20. Resistance to Solvents

Specified Value Note1	Appearance	: No abnormality
	Capacitance change	: $\leq \pm 7.5\%$
	Dissipation factor	: Initial value shall be satisfied
	Insulation resistance	: Initial value shall be satisfied

Test Methods and Remarks	Heat treatment specified in No.5 of the specification shall be conducted prior to test.	
	Add Aqueous wash chemical OKEMCLEAN (A 6% concentrated Oakite cleaner) or equivalent.	
	Measurement shall be performed after test sample following the test is heated at 150+0/-10°C for an hour and kept at room temperature for 24±2 hrs. No.5	

21. Mechanical Shock

Specified Value Note 1	Appearance	: No abnormality
	Capacitance change	: $\leq \pm 7.5\%$
	Dissipation factor	: Initial value shall be satisfied
	Insulation resistance	: Initial value shall be satisfied

Test Methods and Remarks	Heat treatment specified in No5 of the specification shall be conducted prior to test.	
	Three shocks in each direction should be applied along 3 mutually perpendicular axes of the test specimen (18 shocks).	
	Peak value: 1500g	
	Duration: 0.5ms	
	Test pulse: Half-sine	
	Velocity change: 4.7m/s.	
Measurement shall be performed after test sample following the test is heated at 150+0/-10°C for an hour and kept at room temperature for 24±2 hrs. No.5		

► This catalog contains the typical specification only due to the limitation of space. When you consider the purchase of our products, please check our specification. For details of each product (characteristics graph, reliability information, precautions for use, and so on), see our Web site (<http://www.ty-top.com/>).

22. ESD	
Specified Value Note 1	Appearance: No abnormality Insulation resistance: Initial value shall be satisfied
Test Methods and Remarks	Heat treatment specified in No.5 of the specification shall be conducted prior to test. Per AEC-Q200-002 Measurement shall be performed after test sample following the test is heated at 150+0/-10°C for an hour and kept at room temperature for 24±2 hrs. No.5

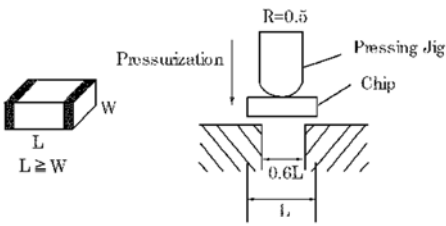
23. Beam Load Test	
Specified Value	2N min (0603 size) 8N min (1005 size min)
Test Methods and Remarks	Per AEC-Q200-003 

Note 1 The figures indicate typical specifications. Please refer to individual specifications in detail.

Multilayer Ceramic Capacitors

PRECAUTIONS

1. Circuit Design

- Precautions**
- ◆ Verification of operating environment, electrical rating and performance
 1. A malfunction of equipment in fields such as medical, aerospace, nuclear control, etc. may cause serious harm to human life or have severe social ramifications. Therefore, any capacitors to be used in such equipment may require higher safety and reliability, and shall be clearly differentiated from them used in general purpose applications.
 - ◆ Operating Voltage (Verification of Rated voltage)
 1. The operating voltage for capacitors must always be their rated voltage or less.
 - If an AC voltage is loaded on a DC voltage, the sum of the two peak voltages shall be the rated voltage or less.
 - For a circuit where an AC or a pulse voltage may be used, the sum of their peak voltages shall also be the rated voltage or less.
 2. Even if an applied voltage is the rated voltage or less reliability of capacitors may be deteriorated in case that either a high frequency AC voltage or a pulse voltage having rapid rise time is used in a circuit.

2. PCB Design

- Precautions**
- ◆ Pattern configurations (Design of Land-patterns)
 1. When capacitors are mounted on PCBs, the amount of solder used (size of fillet) can directly affect the capacitor performance. Therefore, the following items must be carefully considered in the design of land patterns:
 - (1) Excessive solder applied can cause mechanical stresses which lead to chip breaking or cracking. Therefore, please consider appropriate land-patterns for proper amount of solder.
 - (2) When more than one component are jointly soldered onto the same land, each component's soldering point shall be separated by solder-resist.
 - ◆ Pattern configurations (Capacitor layout on PCBs)

After capacitors are mounted on boards, they can be subjected to mechanical stresses in subsequent manufacturing processes (PCB cutting, board inspection, mounting of additional parts, assembly into the chassis, wave soldering of the boards, etc.). For this reason, land pattern configurations and positions of capacitors shall be carefully considered to minimize stresses.

Technical considerations

- ◆ Pattern configurations (Design of Land-patterns)

The following diagrams and tables show some examples of recommended land patterns to prevent excessive solder amounts.

(1) Recommended land dimensions for typical chip capacitors

 - Multilayer Ceramic Capacitors : Recommended land dimensions (unit: mm)

Wave-soldering

Type	1608	2012	3216	3225	
Size	L	1.6	2.0	3.2	3.2
	W	0.8	1.25	1.6	2.5
A	0.8 to 1.0	1.0 to 1.4	1.8 to 2.5	1.8 to 2.5	
B	0.5 to 0.8	0.8 to 1.5	0.8 to 1.7	0.8 to 1.7	
C	0.6 to 0.8	0.9 to 1.2	1.2 to 1.6	1.8 to 2.5	

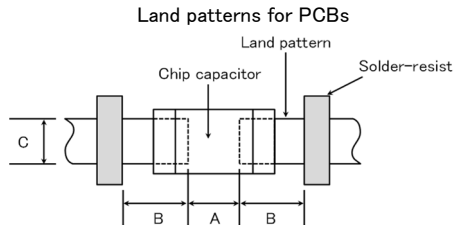

Reflow-soldering

Type	0201	0402	0603	1005	1608	2012	3216	3225	4532
Size	L	0.25	0.4	0.6	1.0	1.6	2.0	3.2	4.5
	W	0.125	0.2	0.3	0.5	0.8	1.25	1.6	3.2
A	0.095~0.135	0.15~0.25	0.20~0.30	0.45~0.55	0.6~0.8	0.8~1.2	1.8~2.5	1.8~2.5	2.5~3.5
B	0.085~0.125	0.10~0.20	0.20~0.30	0.40~0.50	0.6~0.8	0.8~1.2	1.0~1.5	1.0~1.5	1.5~1.8
C	0.110~0.150	0.15~0.30	0.25~0.40	0.45~0.55	0.6~0.8	0.9~1.6	1.2~2.0	1.8~3.2	2.3~3.5

Note: Recommended land size might be different according to the allowance of the size of the product.

 - LWDC: Recommended land dimensions for reflow-soldering (unit: mm)

Type	0510	0816	1220	
Size	L	0.52	0.8	1.25
	W	1.0	1.6	2.0
A	0.18~0.22	0.25~0.3	0.5~0.7	
B	0.2~0.25	0.3~0.4	0.4~0.5	
C	0.9~1.1	1.5~1.7	1.9~2.1	

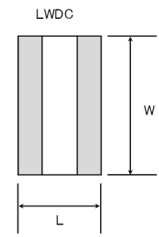

▶ This catalog contains the typical specification only due to the limitation of space. When you consider the purchase of our products, please check our specification. For details of each product (characteristics graph, reliability information, precautions for use, and so on), see our Web site (<http://www.ty-top.com/>).

(2) Examples of good and bad solder application

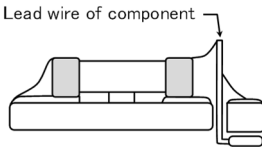
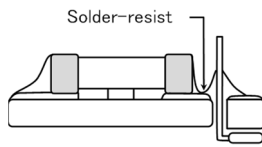
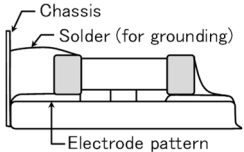
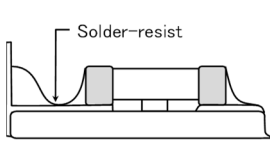
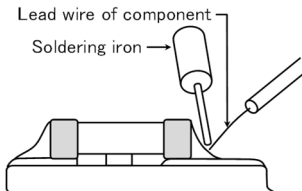
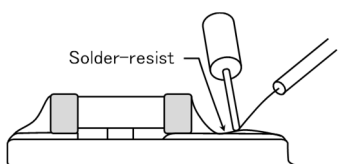
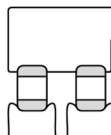
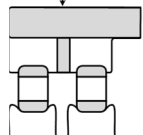
Item	Not recommended	Recommended
Mixed mounting of SMD and leaded components		
Component placement close to the chassis		
Hand-soldering of leaded components near mounted components		
Horizontal component placement		

◆ Pattern configurations (Capacitor layout on PCBs)

1-1. The following is examples of good and bad capacitor layouts ; capacitors shall be located to minimize any possible mechanical stresses from board warp or deflection.

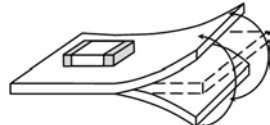
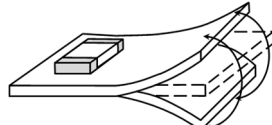
Items	Not recommended	Recommended
Deflection of board		 Place the product at a right angle to the direction of the anticipated mechanical stress.

1-2. The amount of mechanical stresses given will vary depending on capacitor layout. Please refer to diagram below.

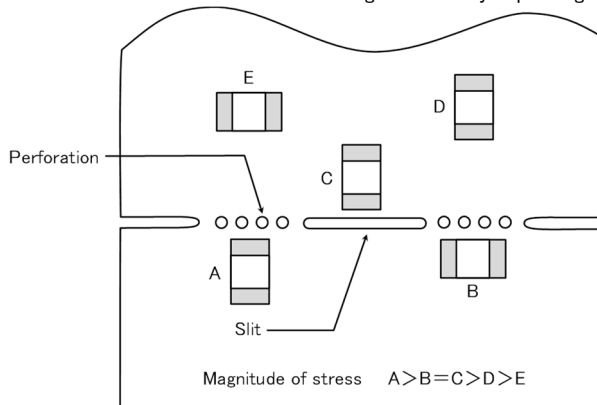

1-3. When PCB is split, the amount of mechanical stress on the capacitors can vary according to the method used. The following methods are listed in order from least stressful to most stressful: push-back, slit, V-grooving, and perforation. Thus, please consider the PCB, split methods as well as chip location.

3. Mounting

Precautions

◆ Adjustment of mounting machine

- When capacitors are mounted on PCB, excessive impact load shall not be imposed on them.
- Maintenance and inspection of mounting machines shall be conducted periodically.

◆ Selection of Adhesives

- When chips are attached on PCBs with adhesives prior to soldering, it may cause capacitor characteristics degradation unless the following factors are appropriately checked : size of land patterns, type of adhesive, amount applied, hardening temperature and hardening period. Therefore, please contact us for further information.

◆ Adjustment of mounting machine

1. When the bottom dead center of a pick-up nozzle is too low, excessive force is imposed on capacitors and causes damages. To avoid this, the following points shall be considerable.
 - (1) The bottom dead center of the pick-up nozzle shall be adjusted to the surface level of PCB without the board deflection.
 - (2) The pressure of nozzle shall be adjusted between 1 and 3 N static loads.
 - (3) To reduce the amount of deflection of the board caused by impact of the pick-up nozzle, supporting pins or back-up pins shall be used on the other side of the PCB. The following diagrams show some typical examples of good and bad pick-up nozzle placement:

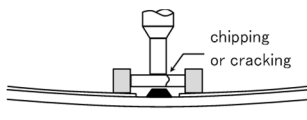
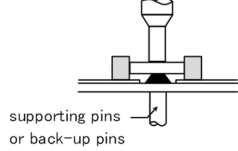
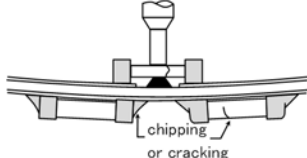
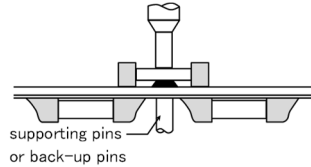
Item	Improper method	Proper method
Single-sided mounting		
Double-sided mounting		

Technical considerations

2. As the alignment pin is worn out, adjustment of the nozzle height can cause chipping or cracking of capacitors because of mechanical impact on the capacitors. To avoid this, the monitoring of the width between the alignment pins in the stopped position, maintenance, check and replacement of the pin shall be conducted periodically.

◆ Selection of Adhesives

Some adhesives may cause IR deterioration. The different shrinkage percentage of between the adhesive and the capacitors may result in stresses on the capacitors and lead to cracking. Moreover, too little or too much adhesive applied to the board may adversely affect components. Therefore, the following precautions shall be noted in the application of adhesives.

- (1) Required adhesive characteristics
 - a. The adhesive shall be strong enough to hold parts on the board during the mounting & solder process.
 - b. The adhesive shall have sufficient strength at high temperatures.
 - c. The adhesive shall have good coating and thickness consistency.
 - d. The adhesive shall be used during its prescribed shelf life.
 - e. The adhesive shall harden rapidly.
 - f. The adhesive shall have corrosion resistance.
 - g. The adhesive shall have excellent insulation characteristics.
 - h. The adhesive shall have no emission of toxic gasses and no effect on the human body.
- (2) The recommended amount of adhesives is as follows:

[Recommended condition]

Figure	2012/3216 case sizes as examples
a	0.3mm min
b	100 to 120 μm
c	Adhesives shall not contact land

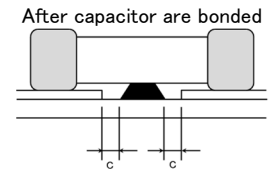
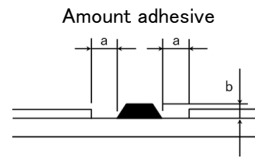

4. Soldering

◆ Selection of Flux

- Since flux may have a significant effect on the performance of capacitors, it is necessary to verify the following conditions prior to use;
- (1) Flux used shall be less than or equal to 0.1 wt% (in Cl equivalent) of halogenated content. Flux having a strong acidity content shall not be applied.
 - (2) When shall capacitors are soldered on boards, the amount of flux applied shall be controlled at the optimum level.
 - (3) When water-soluble flux is used, special care shall be taken to properly clean the boards.

Precautions

◆ Soldering

Temperature, time, amount of solder, etc. shall be set in accordance with their recommended conditions. Sn-Zn solder paste can adversely affect MLCC reliability. Please contact us prior to usage of Sn-Zn solder.

◆ Selection of Flux

- 1-1. When too much halogenated substance (Chlorine, etc.) content is used to activate flux, or highly acidic flux is used, it may lead to corrosion of terminal electrodes or degradation of insulation resistance on the surfaces of the capacitors.
- 1-2. Flux is used to increase solderability in wave soldering. However if too much flux is applied, a large amount of flux gas may be emitted and may adversely affect the solderability. To minimize the amount of flux applied, it is recommended to use a flux-bubbling system.
- 1-3. Since the residue of water-soluble flux is easily dissolved in moisture in the air, the residues on the surfaces of capacitors in high humidity conditions may cause a degradation of insulation resistance and reliability of the capacitors. Therefore, the cleaning methods

Technical considerations

▶ This catalog contains the typical specification only due to the limitation of space. When you consider the purchase of our products, please check our specification. For details of each product (characteristics graph, reliability information, precautions for use, and so on), see our Web site (<http://www.ty-top.com/>).

and the capability of the machines used shall also be considered carefully when water-soluble flux is used.

◆Soldering

- Ceramic chip capacitors are susceptible to thermal shock when exposed to rapid or concentrated heating or rapid cooling.
- Therefore, the soldering must be conducted with great care so as to prevent malfunction of the components due to excessive thermal shock.
- Preheating : Capacitors shall be preheated sufficiently, and the temperature difference between the capacitors and solder shall be within 130°C.
- Cooling : The temperature difference between the capacitors and cleaning process shall not be greater than 100°C.

[Reflow soldering]

【Recommended conditions for eutectic soldering】

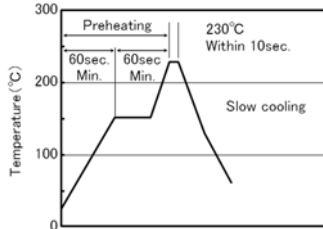

【Recommended condition for Pb-free soldering】

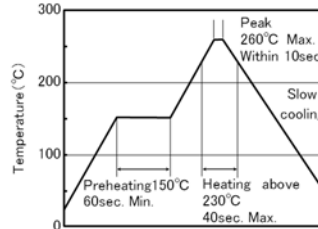

Caution

- ①The ideal condition is to have solder mass (fillet) controlled to 1/2 to 1/3 of the thickness of a capacitor.
- ②Because excessive dwell times can adversely affect solderability, soldering duration shall be kept as close to recommended times as possible. soldering for 2 times.

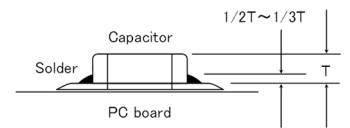

[Wave soldering]

【Recommended conditions for eutectic soldering】

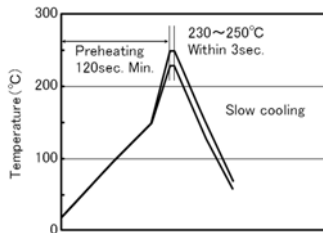

【Recommended condition for Pb-free soldering】

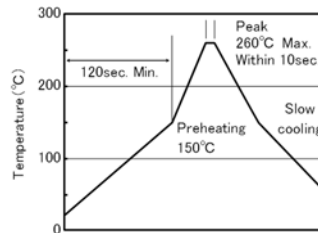

Caution

- ①Wave soldering must not be applied to capacitors designated as for reflow soldering only. soldering for 1 times.

[Hand soldering]

【Recommended conditions for eutectic soldering】

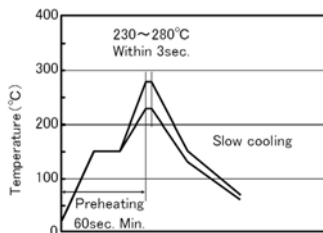

【Recommended condition for Pb-free soldering】

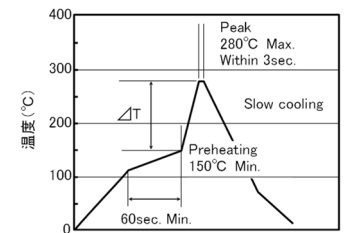
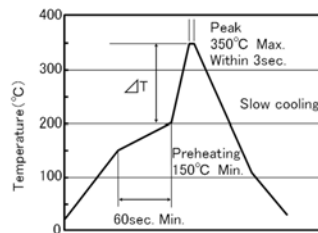

	ΔT
3216type or less	$\Delta T \leq 150^{\circ}\text{C}$

	ΔT
3225type or more	$\Delta T \leq 130^{\circ}\text{C}$

Caution

- ①Use a 50W soldering iron with a maximum tip diameter of 1.0 mm.
- ②The soldering iron shall not directly touch capacitors. soldering for 1 times.

5. Cleaning	
Precautions	<p>◆Cleaning conditions</p> <ol style="list-style-type: none"> When PCBs are cleaned after capacitors mounting, please select the appropriate cleaning solution in accordance with the intended use of the cleaning. (e.g. to remove soldering flux or other materials from the production process.) Cleaning condition shall be determined after it is verified by using actual cleaning machine that the cleaning process does not affect capacitor's characteristics.
Technical considerations	<ol style="list-style-type: none"> The use of inappropriate cleaning solutions can cause foreign substances such as flux residue to adhere to capacitors or deteriorate their outer coating, resulting in a degradation of the capacitor's electrical properties (especially insulation resistance). Inappropriate cleaning conditions (insufficient or excessive cleaning) may adversely affect the performance of the capacitors. In the case of ultrasonic cleaning, too much power output can cause excessive vibration of PCBs which may lead to the cracking of capacitors or the soldered portion, or decrease the terminal electrodes' strength. Therefore, the following conditions shall be carefully checked: Ultrasonic output : 20 W/l or less Ultrasonic frequency : 40 kHz or less Ultrasonic washing period : 5 min. or less
6. Resin coating and mold	
Precautions	<ol style="list-style-type: none"> With some type of resins, decomposition gas or chemical reaction vapor may remain inside the resin during the hardening period or while left under normal storage conditions resulting in the deterioration of the capacitor's performance. When a resin's hardening temperature is higher than capacitor's operating temperature, the stresses generated by the excessive heat may lead to damage or destruction of capacitors. The use of such resins, molding materials etc. is not recommended.
7. Handling	
Precautions	<p>◆Splitting of PCB</p> <ol style="list-style-type: none"> When PCBs are split after components mounting, care shall be taken so as not to give any stresses of deflection or twisting to the board. Board separation shall not be done manually, but by using the appropriate devices. <p>◆Mechanical considerations</p> <p>Be careful not to subject capacitors to excessive mechanical shocks.</p> <ol style="list-style-type: none"> If ceramic capacitors are dropped onto a floor or a hard surface, they shall not be used. Please be careful that the mounted components do not come in contact with or bump against other boards or components.
8. Storage conditions	
Precautions	<p>◆Storage</p> <ol style="list-style-type: none"> To maintain the solderability of terminal electrodes and to keep packaging materials in good condition, care must be taken to control temperature and humidity in the storage area. Humidity should especially be kept as low as possible. <ul style="list-style-type: none"> Recommended conditions Ambient temperature : Below 30°C Humidity : Below 70% RH The ambient temperature must be kept below 40°C. Even under ideal storage conditions, solderability of capacitor is deteriorated as time passes, so capacitors shall be used within 6 months from the time of delivery. <ul style="list-style-type: none"> Ceramic chip capacitors shall be kept where no chlorine or sulfur exists in the air. The capacitance values of high dielectric constant capacitors will gradually decrease with the passage of time, so care shall be taken to design circuits. Even if capacitance value decreases as time passes, it will get back to the initial value by a heat treatment at 150°C for 1hour.
Technical considerations	<p>If capacitors are stored in a high temperature and humidity environment, it might rapidly cause poor solderability due to terminal oxidation and quality loss of taping/packaging materials. For this reason, capacitors shall be used within 6 months from the time of delivery. If exceeding the above period, please check solderability before using the capacitors.</p>
<p>※RCR-2335B (Safety Application Guide for fixed ceramic capacitors for use in electronic equipment) is published by JEITA. Please check the guide regarding precautions for deflection test, soldering by spot heat, and so on.</p>	